

Panasonic®

DIRECTV Digital Satellite Receiver Operating Instructions

TZ-DRD100



For product assistance, please call: 1-888-726-2377 or
send e-mail to: consumerproducts@panasonic.com

TQB2AA0378 10315
PRINTED IN MEXICO

Table of Contents

Important Safety Instructions.....	2	Roller Guide Menu™.....	33
Important Information	4	Navigation/ACTION button.....	33
Information on the DIRECTV Digital		Roller Guide Menu Feature Chart.....	34
Satellite Receiver.....	6	SETUP.....	37
Reception Capability of DIRECTV Digital		Satellite Setup	37
Satellite Receiver.....	6	Monitor	40
Panasonic DIRECTV Digital Satellite		System Test	41
Receiver Model TZ-DRD100	6	Access Card.....	42
Congratulations	7	TV Output.....	43
Customer Record.....	7	ADVANCED PROGRAM GUIDE™	44
Care and Cleaning.....	7	Picture In Guide	45
Specifications.....	7	Searching the Guide by Categories	46
Important Notes	8	Direct Channel Entry	47
Digital Satellite Receiver Location	8	Banner Description Icons	47
Connecting Cables	8	Grid	48
AC Power Supply Cord.....	8	LOCK	49
Satellite Dish Antenna Connection	8	Password	49
Antenna/Cable Connection.....	9	Unlock	50
TZ-DRD100 Front Panel	10	Movies Limits	51
TZ-DRD100 Rear Panel.....	11	TV Limits	52
Features of the Digital Satellite		Channel Locks	53
Receiver.....	12	Spending.....	54
DIRECTV Channel Banner	12	ACCOUNT.....	55
Viewing modes	14	Future Purchases.....	55
Tuning modes	15	Past Purchases	56
Getting Started.....	17	Messages.....	56
Step 1. Connect AC Power Cord.....	17	OPTIONS	57
Step 1a. DIRECTV Satellite Dish Connection	17	Audio	57
Step 1b. Antenna / Cable Connection	17	Clock	58
Step 1c. Digital Satellite Connection to TV or Monitor.....	18	Favorites	59
Step 1d. Connection to Satellite Dish, Cable box and		About.....	60
Terrestrial Antenna.....	19	Upgrades.....	61
Step 1e. Digital Satellite Receiver Connection to VCR	20	Features	61
Step 2. Turning Digital Satellite Receiver ON.....	21	TIMER	62
Step 3. Roller Guide Menu™.....	21	Timer error Messages	63
Step 3a. ACTION/Navigation Button	21	Glossary and Acronyms.....	64
Remote Control Guide	22	Troubleshooting Table	66
Remote Control Functional Key Chart.....	23	Service Information.....	67
Battery Installations and Precautions	24		
Special Remote Buttons	25		
Programming the Remote Control.....	26		
Remote Control Component Codes	27		
Special Features of the Digital			
Satellite Receiver	29		
Impulse pay per view.....	29		
Software Upgrade Messages	32		

Read these instructions completely before operating.

Specifications are subject to change without notice or obligation.

Copyright 2001 by Matsushita Electric Corporation of America. All rights reserved. Unauthorized copying and distribution is a violation of law.

IMPORTANT SAFETY INSTRUCTIONS

IMPORTANT SAFETY INSTRUCTIONS

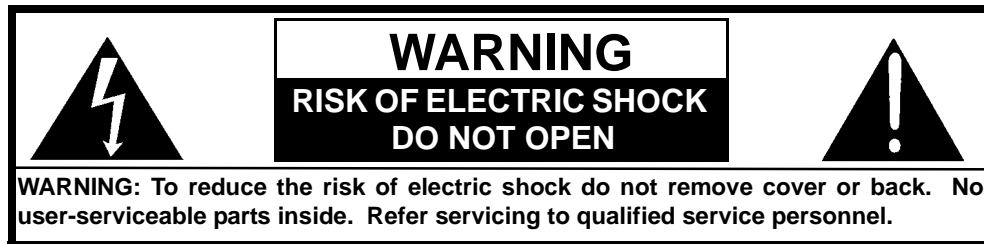

The lightning flash with arrow head within a triangle is intended to tell the user that parts inside the product are a risk of electric shock to persons.



The exclamation point within a triangle is intended to tell the user that important operating and servicing instructions are in the papers with the appliance.

Note To CATV System Installer: This reminder is provided to call the CATV system installer's attention to article 820-40 of the National Electric Code that provides guidelines for proper grounding and, in particular, specifies that the cable ground shall be connected to the grounding system of the building, as close to the point of cable entry as practical.

Note To Satellite Dish Installer:

This reminder is provided to call your attention to Article 810 and in particular article 810-15 of the National Electrical Code which covers proper installation and grounding of television receiving equipment as well as to article 820-40 of the National Electrical Code which specifies that the satellite dish cable ground shall be connected to the grounding system of the building as close to the point of cable entry as practical.

Important Safety Instructions For The Digital Satellite Receiver:

1. Read and apply the operating instructions provided with Digital Satellite Receiver.
2. Read all of the instructions given here and retain them for later use.
3. Unplug this Digital Satellite Receiver from the wall outlet before cleaning. Do not use liquid or aerosol cleaners. Use a damp cloth for cleaning.
4. Do not use attachments not recommended by the Digital Satellite Receiver manufacturer as they may cause hazards.
5. Do not use this Digital Satellite Receiver near water. For example: Avoid placing it near a bathtub, washbowl, kitchen sink, or laundry tub, in a wet basement, or near a swimming pool, etc.
6. Do not place this Digital Satellite Receiver on an unstable cart, stand, or table. The Digital Satellite Receiver may fall, causing serious injury to a child or adult and serious damage to the appliance. Use only with a cart or stand recommended by the manufacturer, or sold with the Digital Satellite Receiver. Wall or shelf mounting should follow the manufacturer's instructions, and should use a mounting kit approved by the manufacturer.
- 6a. An appliance and cart combination should be moved with care. Quick stops, excessive force, and uneven surfaces may cause the appliance and cart combination to overturn.
7. Slots and openings in the cabinet and the back or bottom are provided for ventilation, and to insure reliable operation of the Digital Satellite Receiver and to protect it from overheating. These openings must not be blocked or covered. The openings should never be blocked by placing the Digital Satellite Receiver on a bed, sofa, rug or other similar surface. This Digital Satellite Receiver should never be placed near or over a radiator or heat register. This Digital Satellite Receiver should not be placed in a built-in installation such as a bookcase unless proper ventilation is provided.
8. Operate only from the type of power source indicated on the marking label. If you are not sure of the type of power supplied to your home consult your Video dealer or local power company. For Digital Receivers designed to operate from battery power, refer to the operating instructions.
9. This Digital Satellite Receiver is equipped with a polarized alternating-current line plug (a plug having one blade wider than the other). This plug will fit into the power outlet only one way. This is a safety feature. If you are unable to insert the plug fully into the outlet, try reversing the plug. If the plug should still fail to fit, contact your electrician to replace your obsolete outlet. Do not defeat the safe purpose of the polarized plug,
10. Do not allow anything to rest on the power cord. Do not locate this Digital Satellite Receiver where the cord will be abused by persons walking on it.
11. Follow all warnings and instructions marked on the Digital Satellite Receiver.



IMPORTANT SAFETY INSTRUCTIONS

12. Do not overload wall outlets and extension cords as this can result in fire or electric shock.
13. Never push objects of any kind in to this Digital Satellite Receiver through cabinet slots as they may touch dangerous voltage points or short out parts that could result in a fire or electric shock. Never spill liquid of any kind on the Digital Satellite Receiver.

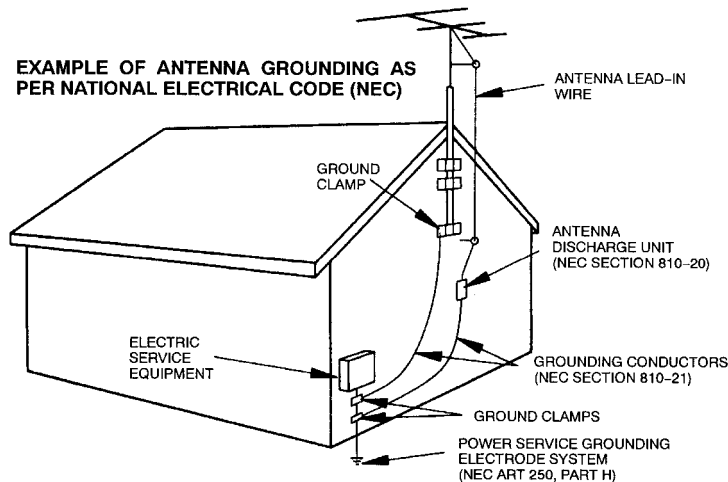

14. If an outside antenna is connected to the decoder equipment, be sure the antenna system is grounded so as to provide some protection against voltage surges and built up static charges. In the U.S. Section 810 of the National Electrical Code, ANSI/NFPA 70 provides information with respect to proper grounding of the mast and supporting structure, grounding of the lead-in wire to an antenna discharge unit, size of grounding conductors, location of antenna-discharge unit, connection to grounding electrodes, and requirements for the grounding electrode. See Figure.
15. For added protection for this Digital Satellite Receiver during a lightning storm, or when it is left unattended and unused for long periods of time, unplug it from the wall outlet and disconnect the antenna. This will prevent damage to the decoder due to lightning and power-line surges.
16. An outside antenna system should not be located in the vicinity of overhead power lines or other electric light or power circuits, or where it can fall into such power lines or circuits. When installing an outside antenna system extreme care should be taken to keep from touching such power lines or circuits as contact with them might be fatal.
17. Unplug this Digital Satellite Receiver from the wall outlet, and refer servicing to qualified service personnel under the following conditions:
 - a. When the power cord or plug is damaged or frayed.
 - b. If liquid has been spilled into the Digital Satellite Receiver.
 - c. If the Digital Television Decoder has been exposed to rain or water.
 - d. If the Digital Satellite Receiver does not operate normally by following the operating instructions. Adjust only those controls that are covered by the operating instructions as improper adjustment of other controls may result in damage and will often require extensive work by a qualified technician to restore the Digital Satellite Receiver to normal operation.
 - e. If the Digital Satellite Receiver has been dropped or the cabinet has been damaged.
 - f. When the Digital Satellite Receiver exhibits a distinct change in performance - this indicates a need for service.
18. Do not attempt to service this Digital Television Decoder yourself as opening or removing covers may expose you to dangerous voltage or other hazards. Refer all servicing to qualified service personnel.
19. When replacement parts are required, be sure the service technician has used replacement parts specified by the manufacturer that have the same characteristics as the original part. Unauthorized substitutions may result in fire, electric shock, or other hazards.
20. Upon completion of any service or repairs to this Digital Satellite Receiver, ask the service technician to perform routine safety checks to determine that the decoder is in safe operating condition.
21. **WARNING: TO PREVENT FIRE OR SHOCK HAZARD, DO NOT EXPOSE THIS APPLIANCE TO RAIN OR MOISTURE.**
22. **CAUTION: TO PREVENT ELECTRIC SHOCK DO NOT USE THIS (POLARIZED) PLUG WITH A RECEPTACLE OR OTHER OUTLET UNLESS THE BLADES CAN BE FULLY INSERTED TO PREVENT BLADE EXPOSURE.**

Note: DIRECTV® service can only be received within the USA and is not available in Canada

IMPORTANT INFORMATION
Important Information

FCC INFORMATION

Your Digital Satellite Receiver is registered with the Federal Communications Commission and is in compliance with CFR47, Parts 15 and 68, FCC Rules and Regulations.

Radio Interference

This equipment has been tested and found to comply with the limit for a Class B Digital Device in accordance with the specifications in Part 15 of FCC Rules. The rules are designed to provide reasonable protection against radio and television interference in a residential installation. This equipment generates, uses and can radiate radio frequency energy and, if not installed and used in accordance with the instructions, may cause harmful interference to radio communications. However, there is no guarantee that interference will not occur in a particular installation.

If this equipment does cause interference to radio or televisions reception (which you can determine by turning the equipment off and on), try to correct the interference by one or more of the following measures.

- Reposition or relocate the receiving antenna for the radio or television that is "receiving" the interference.
- Change the position of the Digital Satellite Receiver with respect to the radio or television equipment that is receiving interference.
- Move the Digital Satellite Receiver away from equipment receiving interference.
- Plug the Digital Satellite Receiver into a different wall outlet so the Digital Satellite Receiver and equipment receiving the interference are on different branch circuits.

If these measures do not eliminate interference, please consult your dealer or an experienced radio/television technician for assistance..

FCC CAUTION:

Pursuant to 47CFR, Part 15.21 of the FCC rules, any changes or modifications to this Digital Satellite Receiver not expressly approved by Matsushita Electric Corporation of America could cause harmful interference and would void the user's authority to operate this device.

A FCC compliant modem cable with modular plug is provided with this equipment. This equipment is designed to be connected to the telephone network or premises wiring using a compatible modular jack that is Part 68 compliant. See Installation Instructions for details.

FCC Declaration of Conformity
<p>PANASONIC CONSUMER ELECTRONICS COMPANY Responsible party: Matsushita Electric Corporation of America One Panasonic Way Secaucus, NJ 07094 U.S.A.</p> <p>Telephone Number: 1-888-726-2377 (8 a.m.-10 p.m., Mon-Fri, EST) (10 a.m.-10 p.m., Sat-Sun, EST) OR E-MAIL: CONSUMER PRODUCTS@PANASONIC.COM</p> <p>This device complies with Part 15 of the FCC rules. Operation is subject to the following two conditions: (1) this device may not cause harmful interference, and (2) this device must accept any interference received, including interference that may cause undesired operation.</p>

Notification to the Local Telephone Company

On the back of this equipment is a label indicating among other information, the FCC Registration number and Ringer Equivalence Number (REN) for the equipment. You must, upon request, provide this information to your telephone company. The REN is useful to determine the number of devices you may connect to your telephone line and still have all these devices ring when your telephone number is called. In most (but not all) areas, the sum of the RENs of all devices connected to one line should not exceed 5. To be certain of the number of devices you may connect to your line as determined by the REN, you should contact your local telephone company.

Notes: This equipment may not be used on coin service provided by the telephone company. Party lines are subject to state tariffs, and therefore, you may not be able to use your own telephone equipment if you are on a party line. Check with your local telephone company. Notice must be given to the telephone company upon permanent disconnection of your Digital Satellite Receiver from your line.

Rights of the Telephone Company

Should your equipment cause trouble on your line which may harm the telephone network, the telephone company shall, where practicable, notify you that temporary discontinuance of service may be required. Where prior notice is not practicable and the circumstances warrant such action, the telephone company may temporarily discontinue service immediately. In case of such temporary discontinuance, the telephone company must: (1) promptly notify you of such temporary discontinuance (2) afford you the opportunity to correct the situation and (3) inform you of your right to bring a complaint to the Commission pursuant to procedures set forth in Subpart E of Part 68, FCC Rules and Regulations. The telephone company may make changes in its communication facilities, equipment, operations of procedures where such action is required in the operation of its business and not inconsistent with FCC Rules and Regulations. Of these changes are expected to affect the use or performance of your telephone equipment, the telephone company must give you adequate notice, in writing, to allow you to maintain uninterrupted service.

INFORMATION ON THE DIRECTV DIGITAL SATELLITE RECEIVER **Information on the DIRECTV Digital Satellite Receiver**

Reception capability of DIRECTV Digital Satellite Receiver

The Panasonic Digital Satellite Receiver is capable of receiving DIRECTV®* digital satellite signals and converting them to standard definition signal. You may connect a terrestrial or cable antenna to the VHF/UHF ANT input of the Digital Satellite Receiver.

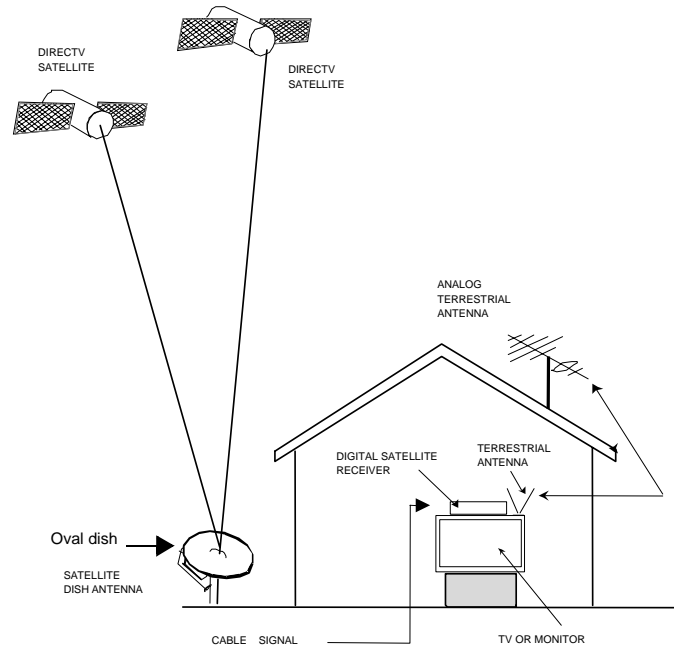

Terrestrial off-air signals **or** unscrambled cable-service signals can be passed through the Digital Satellite Receiver when the antenna is connected to the VHF/UHF IN input and the Digital Satellite Receiver is **Off** or when the user presses the TV/SAT button on the remote. The desired channels are tuned by the television.

Panasonic DIRECTV Digital Satellite Receiver Model TZ-DRD100

Panasonic Digital Satellite Receiver with a built-in DIRECTV Receiver, can receive and process DIRECTV standard definition video from satellite broadcasts if you subscribe to DIRECTV® programming. Model TZ-DRD100 uses specially developed chips which allow current televisions (with A/V inputs) to display digitally broadcast programs. This Digital Satellite Receiver also has a RF OUT jack, which enables the unit to be hooked up to a television without A/V inputs. The Digital Satellite Receiver, which receives digital signals, has the ability to convert the digital broadcast into National Television System Committee (NTSC)** signals that a conventional television can display.

*DIRECTV and the Cyclone Design logo and Advanced Program Guide are trademarks of DIRECTV, Inc., a unit of Hughes Electronics Corp., and are used with permission.

**NTSC is the current television system used in the U.S. It uses analog (non-digital) signals.

Congratulations

Your Panasonic Digital Satellite Receiver features state-of-the-art technology for high-quality picture and sound with complete audio/video output jacks for your home theater system. This Digital Satellite Receiver is capable of receiving DIRECTV® standard definition satellite signals. DTV signals are displayed in interlaced format, providing a clear, crisp picture. Your new Digital Satellite Receiver is designed to give you many years of enjoyment.

Customer Record

The model and serial number of this product are located on the back of the Digital Satellite Receiver. You should note the model and serial number in the space provided and retain as a permanent record of your purchase. This will aid in identification in the event of theft or loss. Product registration is available on-line at: **www.prodreg.com\panasonic.**

Model	TZ - DRD100
Number	
Serial	
Number	

Care and Cleaning

Turn Digital Satellite Receiver Off

- For Digital Satellite Receiver, avoid excessive moisture and wipe dry.
- Avoid bumping or scraping the Digital Satellite Receiver.

Remote Control

- For Remote Control, use a soft cloth dampened with water or a mild detergent solution. Avoid excessive moisture and wipe dry.
- Do not use benzene, thinner or other petroleum based products.

Specifications

Power Source	120V AC, 60Hz
Channel Capability – NTSC and CABLE	VHF/UHF - 2-69* (Passthrough) CATV - 1-125* (Passthrough)
Satellite Signal Range	950 - 1450 Mhz (L-Band)
NTSC Video Output jack	1V _{p-p} , 75 Ohm, Phono Jack Type
NTSC Audio Output jacks	0-2.0V rms 4.7k Ohm
VHF / UHF ANT IN jack	75 Ohm, F Connector
VHF / UHF (Passthrough) , SAT OUT jack	75 Ohm, F Connector
Modem Jack	RJ11C, 4 Conductor

Specifications are subject to change without notice or obligation.

*The digital tuning system allows channel numbers up to 9999 to be displayed. The total channel capability, however, remains as stated.

Note: *The Digital Satellite Receiver will only passthrough your off-air antenna or cable signals. You must tune off-air or cable channels with your television or cable box.*

IMPORTANT NOTES

Important Notes

Digital Satellite Receiver Location

This unit can be used as part of an entertainment center. Consult your dealer for available options.

- Avoid excessive sunlight or bright lights.
- Keep away from excessive heat or moisture. Inadequate ventilation may cause internal component failure.
- Fluorescent lighting may reduce Remote Control transmitting range.

Connecting Cables

Shielded audio/video cables (provided) should be used for all connections between components. For best results:

- Use 75 Ohm coaxial shielded cables.
- Check type of output and input connectors on your components.
- Determine required cable lengths.

AC Power Supply Cord

CAUTION: TO PREVENT ELECTRIC SHOCK, MATCH WIDE BLADE OF PLUG TO WIDE SLOT OF AC OUTLET AND FULLY INSERT. DO NOT USE A PLUG WITH A RECEPTACLE OR OTHER OUTLET UNLESS THE BLADE CAN BE FULLY INSERTED TO PREVENT BLADE EXPOSURE.

Polarized Plug

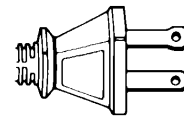

PROTECT POWER CORDS FROM BEING WALKED ON, ROLLED OVER, CRIMPED, BENT OR PINCHED, PARTICULARLY AT PLUGS, CONVENIENCE RECEPTACLES, AND THE POINT WHERE THEY EXIT FROM THE APPARATUS.

Satellite Dish Antenna Connection

Connect the cable coming from the DIRECTV satellite dish to the Satellite In jack on the Digital Satellite Receiver.

Note: *With this receiver and the proper satellite dish antenna, you may be able to subscribe to local channels from DIRECTV in certain markets. Additional equipment may be required in some areas. Check with your retailer or visit DIRECTV.com for information on availability of local channels from DIRECTV in your area.*

Antenna/Cable Connection

A terrestrial antenna or cable antenna may be connected to the VHF/UHF IN jack of the Digital Satellite Receiver. This input works as a passthrough. The VHF/UHF channels can be passed through either by toggling TV/SAT button on remote control or by turning the Digital Satellite Receiver off. The RF output (VHF (SAT) UHF OUT) of the Digital Satellite Receiver must be connected to the television.

Antenna Connection

For proper reception of VHF/UHF channels, a directional antenna is required. For best reception, an outdoor antenna is recommended.

Procedure

- Connect the antenna cable from your antenna to the VHF/UHF IN jack of the Digital Satellite Receiver.

**Incoming Cable from
Home Antenna**

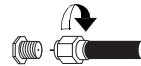

75 Ohm ANT IN input on back
of Digital Satellite Receiver

Cable Connection

Before connecting your cable to the Digital Satellite Receiver, contact your local cable provider and ask the following question:

- Do you need a separate cable box to receive cable channels in your area?

Procedure

- Connect the cable wire provided by your local cable provider.

**Incoming Cable from
Cable Provider**

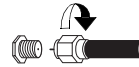

75 Ohm ANT IN input
on back of Digital Satellite
Receiver

FRONT AND REAR VIEW OF THE DIGITAL SATELLITE RECEIVER **Front and Rear View of the Digital Satellite Receiver**

Front Panel

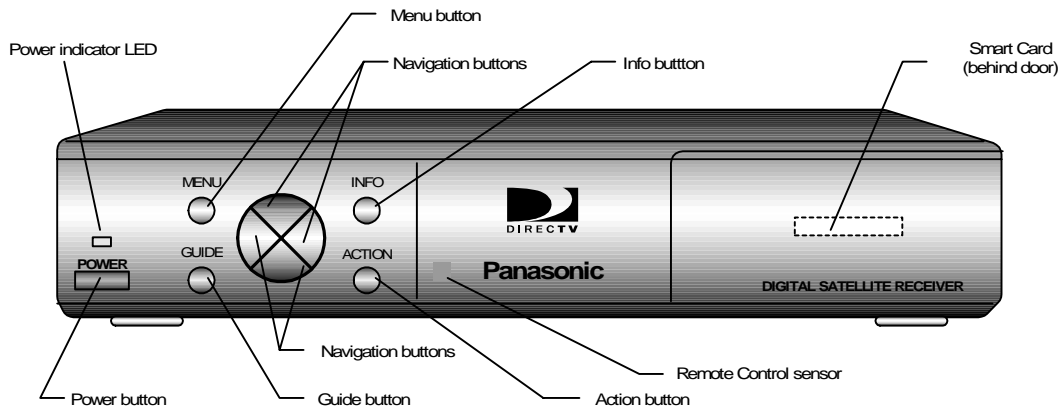

POWER	Turns the Digital Satellite Receiver On.
MENU	Press to enter and exit Roller Guide Menu system.
GUIDE	Press to access the Advanced Program Guide™.
INFO	Press to display the Channel banner or to search within the Guide.
ACTION	Press to enter selection from the Guide or from the Menu.
NAVIGATION BUTTONS	Press the navigation arrows to move the highlight up, down, left or right.
SMART CARD	Also known as Access Card, identifies you to your program providers. The DIRECTV System requires a valid card. (Slide the door to the right to access the smart card.)

Notes:

- DIRECTV programming sold separately.
- Programming subject to change. You must be physically located in the U.S. to receive DIRECTV service. DIRECTV services not available outside the U.S. DIRECTV programming is sold separately and independently of DIRECTV System hardware. A valid programming subscription is required to operate DIRECTV System hardware. Activate your DIRECTV programming today at 1-800 DIRECTV (1-800-347-3288).

FRONT AND REAR VIEW OF THE DIGITAL SATELLITE RECEIVER

Rear Panel

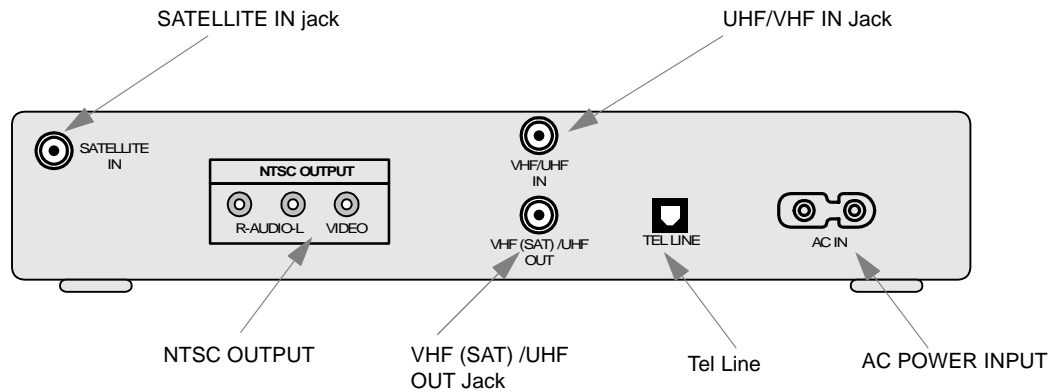

SATELLITE IN	Use to connect DIRECTV satellite dish antenna to the Digital Satellite Receiver.
VHF/UHF IN	Use to connect an off-air antenna or cable TV signal to the Digital Satellite Receiver. This input serves as a passthrough for off-air antenna or cable signal when the user presses the TV/SAT button or when the Digital Satellite Receiver is powered off.
VHF (SAT) / UHF OUT	Use to connect the Digital Satellite Receiver to your TV.
NTSC OUTPUT	Use to connect the Digital Satellite Receiver to a TV or Monitor. By using the audio/video jacks, you will get better picture and sound quality.
TEL LINE	Use to connect a phone line to the Digital Satellite Receiver to enable receipt of certain DIRECTV [®] services.

FEATURES OF THE DIGITAL SATELLITE RECEIVER

Features of the Digital Satellite Receiver

DIRECTV Channel Banner

The Channel Banner is available with DIRECTV® programming to show you which channel and program you are currently viewing or have selected. The following figure shows the DIRECTV channel banner. The DIRECTV channel banner description area can be expanded, if the user presses the **INFO** key.

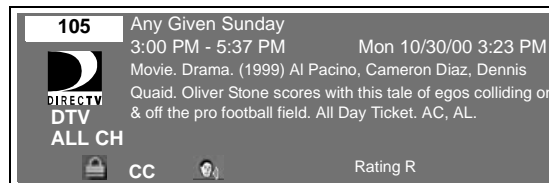

The DIRECTV Channel Banner

In addition to viewing the program description, the user can add or remove the channel from the favorite channel list. This is accomplished by navigating left or right and pressing the **ACTION** key.

Channel Banner: Favorite Channel List

The favorite channel list is a customized list that allows you to create your own unique channel list. The favorite channel list is active when you select the "FAV CH" mode in the guide screen. By default, the "ALL CH" mode is selected. Also, by default, both the "ALL" mode and "FAV" modes default to all the channels selected in their lists.

When the description of the channel banner is expanded, the user now has the opportunity to add or remove a channel from the favorite list. By default,

Delete from FAV button is highlighted when the Channel Banner is expanded. Once a channel is removed from the favorite list, the user is required to numerically enter in the channel number to view that channel, at which time the user can add the channel back into the favorite channel list.

The following figure depicts the Channel Banner, when the Description area is highlighted.



Channel Banner

FEATURES OF THE DIGITAL SATELLITE RECEIVER

Channel Banner: Components

The Channel Banner is used to show you which channel and program you are currently viewing or selecting. The figure below indicates the various components of the Channel Banner.

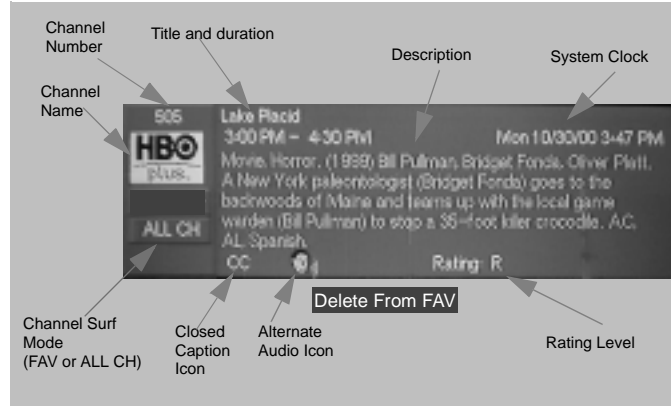

Channel Banner Components

The following figure displays some of the information that can possibly be displayed, simultaneously.

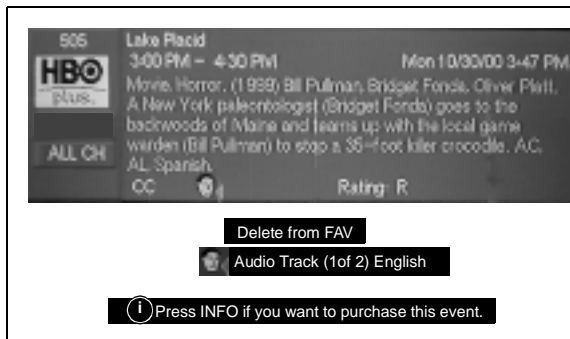



Channel Banner with OSD Messages

FEATURES OF THE DIGITAL SATELLITE RECEIVER

Icons: Channel Banner

The Channel Banner contains several icons that are displayed only when the feature is available and is supported by the Digital Satellite Receiver. The following figure and table depicts the location and appearance of these icons.

Icon Name	Icons Description	Icon Appearance
Messages	Indicates that there is an unread message.	
Lock	Indicates that the channel is locked due to either limits on spending or by content advisory.	
Alternate Audio	Indicates that the current program has multiple audio tracks.	
Closed Captioning	Indicates that the program has Closed Captioning.	CC

Viewing Modes

This section describes the user interface that is directly controlled by remote or front panel. The following operational modes are supported by this interface:

- Tuning Mode
- Recall Display Mode
- Exiting Tuning Mode

Normal Viewing Mode

Normal Viewing Mode is defined as only the video being displayed and possibly closed captioning data. When Digital Satellite Receiver is first powered on, it will be in the Normal Viewing mode.

Note: *The first time the Digital Satellite Receiver is powered On, all channels except those exceeding the MPAA or TV rating limits and channels not authorized by DIRECTV are shown.*

Once the user has created a favorite channel list, the Digital Satellite Receiver will channel surf only to channels that are part of the favorite channel list. The user may tune to a channel that is not a member of the favorite channel list by entering in a channel number, explained in the Direct Tuning Method section. The user must add this channel using the menu system.

FEATURES OF THE DIGITAL SATELLITE RECEIVER

Power On Requirements

When the Digital Satellite Receiver is powered on, the receiver will tune to the last tuned channel. If this channel no longer exists, the receiver will tune to channel 100. Prior to initial setup of the receiver, the receiver may automatically go to Setup menu or tune to channel 100.

Tuning Mode

The Tuning Mode happens when the user attempts to change the channel. The Digital Satellite Receiver will support 3 ways to change the channel, as outlined below:

Method	Result
• Direct Tuning (0-9 and PROG keys)	Tunes directly to a channel using either single or compound numbers.
• Channel UP/Down Tuning (▲▼ keys)	Tunes to the next/previous available channel.
• Rapid Tune (R-TUNE)	Switches between the last two channels, accessed. This is accomplished using the R-TUNE key on the remote.

Direct Tuning Method

The Digital Satellite Receiver supports the tuning of either single or compound channel numbers. The single channel numbers range from (0 to 9999) and compound channel numbers (major-minor) can range from (0-0 to 999-99)*. The compound channel number uses the "**PROG**" button to enter the minor number field. Following is an example of Direct tuning screen.

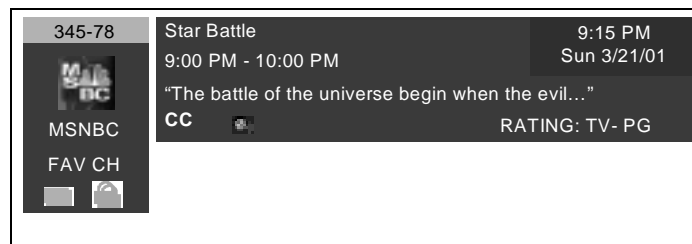

Direct Tuning example

*For example, 120-1 is an example of a compound number. 120 is the major number and 1 is the minor number.

FEATURES OF THE DIGITAL SATELLITE RECEIVER

Tuning Mode (Cont.)

Example of Non-compound (Single) Channel Number Input

For example, to tune channel 345, you enter the channel number by using the number keys (0-9) on the remote control. Then press the **ACTION** button which causes the tuning event to occur.

Example of Compound Channel Number Input

A compound numbers (major-minor) can range from (0-0 to 999-99). For example, to enter channel number 345-78, you do the following.

- Press the numeric buttons 3, 4 and 5 on the remote control.
- Press **PROG** button to enter the minor number field.
- Press number 7 and 8 buttons on the remote control.
- Press **ACTION** button to complete the tuning event.

Note: If you do not enter a number after 3 seconds, the number 0 is assumed for the minor number.

Unavailable Channel Selection

The “Channel Not Available” screen is displayed when you select an unavailable channel. The following is a list of some possible situations where an unavailable channel selection may occur.

- Tuning to a channel that is not transmitting any programs.
- Tuning to a channel that is blocked either by spending or content advisory limits.
- The signal strength of the RF signal is insufficient to obtain consistent error free data.

Following is an example of Channel Not Available screen.

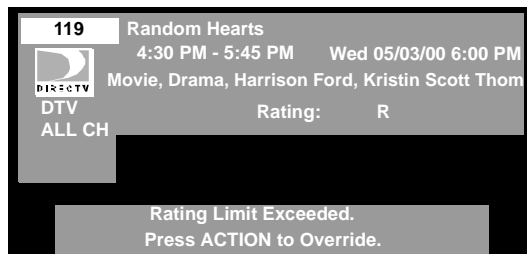

Channel Not Available Screen

The following is an example of insufficient credit.

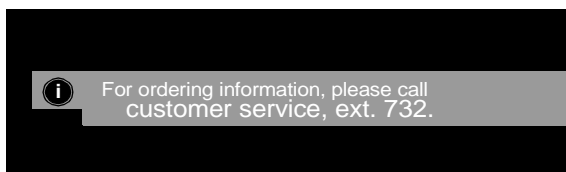

Getting Started

Step 1. Connect AC Power Cord

Plug the AC power cord into a grounded outlet. Do not turn on any devices until you have finished making all necessary connections.

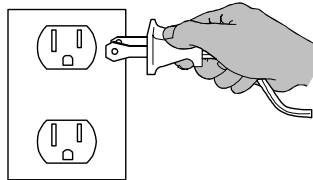

Step 1a. DIRECTV Satellite dish Connection

Connect the DIRECTV Satellite dish download to the Satellite In jack on the rear panel of the Digital Satellite Receiver.

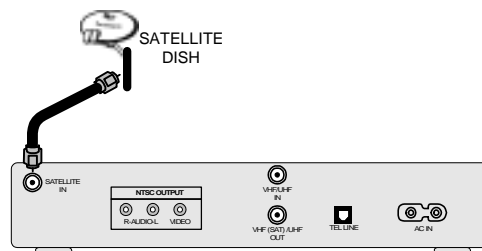

Note: With this receiver and the proper satellite dish antenna, you may be able to subscribe to local channels from DIRECTV in certain markets. Additional equipment may be required in some areas. Check with your retailer or visit DIRECTV.com for information on availability of local channels from DIRECTV in your area.

Step 1b. Antenna/Cable Connection

Connect the antenna or cable wire to the VHF/UHF IN jack on the rear panel of the Digital Satellite Receiver. The signal from the terrestrial antenna or cable will be passed through when the user presses the TV/SAT button on the remote control or when the digital satellite receiver is **off**. The RF output of the Digital Satellite Receiver must be connected to the television.

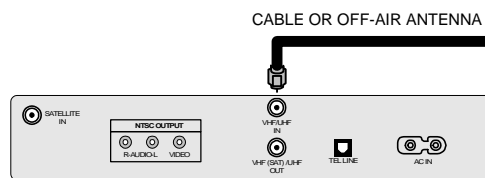

GETTING STARTED

Step 1c. Digital Satellite Receiver connection to TV or Monitor

Follow this diagram when connecting the Digital Satellite Receiver to a Television or Monitor.

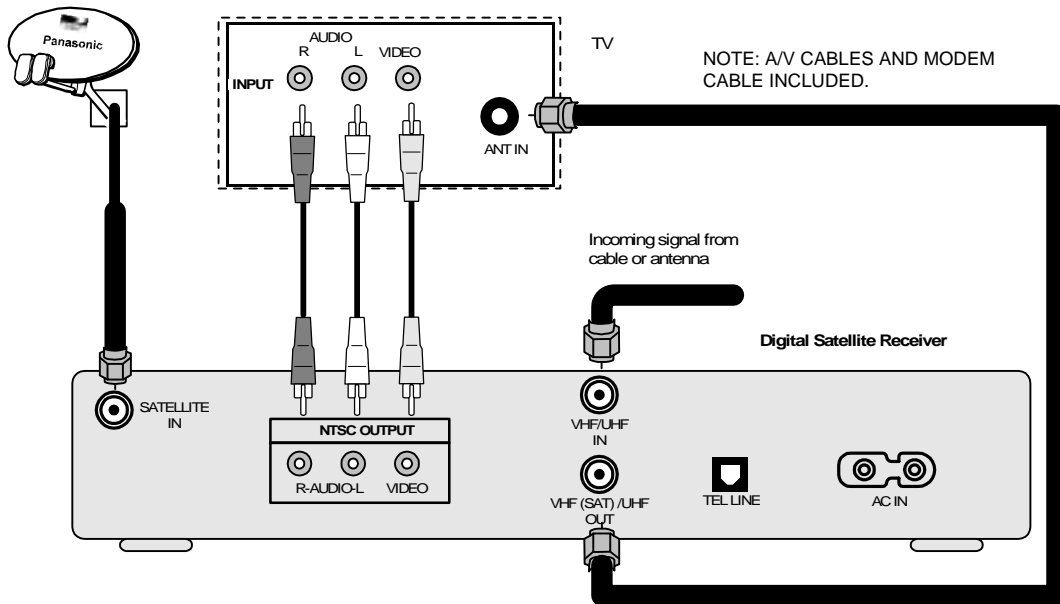

DIGITAL SATELLITE RECEIVER CONNECTION TO TV OR MONITOR

Procedure

- Connect the VHF (SAT) /UHF OUT to the ANT IN of the television or connect video cable from the video output jack on the Digital Satellite Receiver to the video input jack on the TV.
- Connect audio cables from the left and right NTSC audio output jacks on the Digital Satellite Receiver to the left and right audio input jacks on the TV.

To receive off-air programming (no cable box)

- Turn off the Digital Satellite Receiver or press **TV/SAT** button to toggle.
- Tune TV to desired channel.

To receive off-air programming (with cable box)

- Turn off the Digital Satellite Receiver or press **TV/SAT** button to toggle.
- Tune TV to cable box output channel (either CH3 or Ch4).
- Tune the cable channels using the cable box.

Note: Modem should also be connected to a telephone jack using the cable supplied RJ11C cable if impulse pay per view services are desired.

Step 1d. Digital Satellite Receiver, Satellite dish, Cable box and terrestrial antenna

Follow this diagram if you have Satellite service, cable box and terrestrial antenna. Cable or terrestrial antenna signal is passed through when you press **TV/SAT** button to toggle or when the Digital Satellite Receiver is turned **off**.

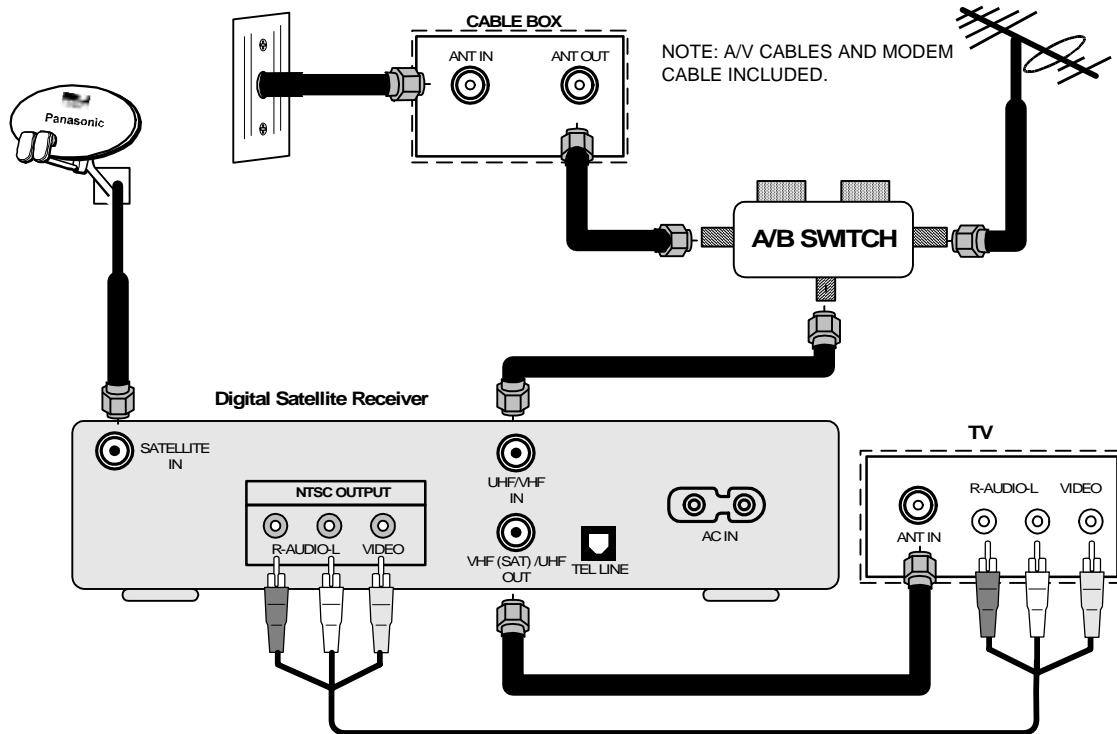

DIGITAL SATELLITE RECEIVER, SATELLITE DISH, CABLE BOX AND TERRESTRIAL ANTENNA

Procedure

- Connect the antenna cable to one of the inputs (A or B) of the A/B switch.
- If using a cable box, connect the cable wire from the wall jack to the cable box ANT (antenna) IN jack using a standard RF cable with coaxial connector and connect the cable box ANT (antenna) OUT jack to the other input (A or B) of the A/B switch.
- If not using a cable box, connect the cable wire from the wall jack to the second input of the A/B switch using an RF cable (not shown).
- Connect the OUT signal of the A/B switch to the ANT IN jack of the Digital Satellite Receiver.
- Connect the VHF (SAT) /UHF OUT jack to the Conventional TV or Monitor by using a RF cable.
- Connect the NTSC OUTPUTS of the Digital Satellite Receiver to the A/V inputs of the television or monitor.

Note: If viewing video using RF Input, select either CH 3 or CH 4 in TV Output section in the Setup menu. Tune your television to the same channel (either CH 3 or CH 4).

GETTING STARTED

Step 1e. Digital Satellite Receiver Connection to VCR

Follow this diagram when connecting the Digital Satellite Receiver to a standard VCR.

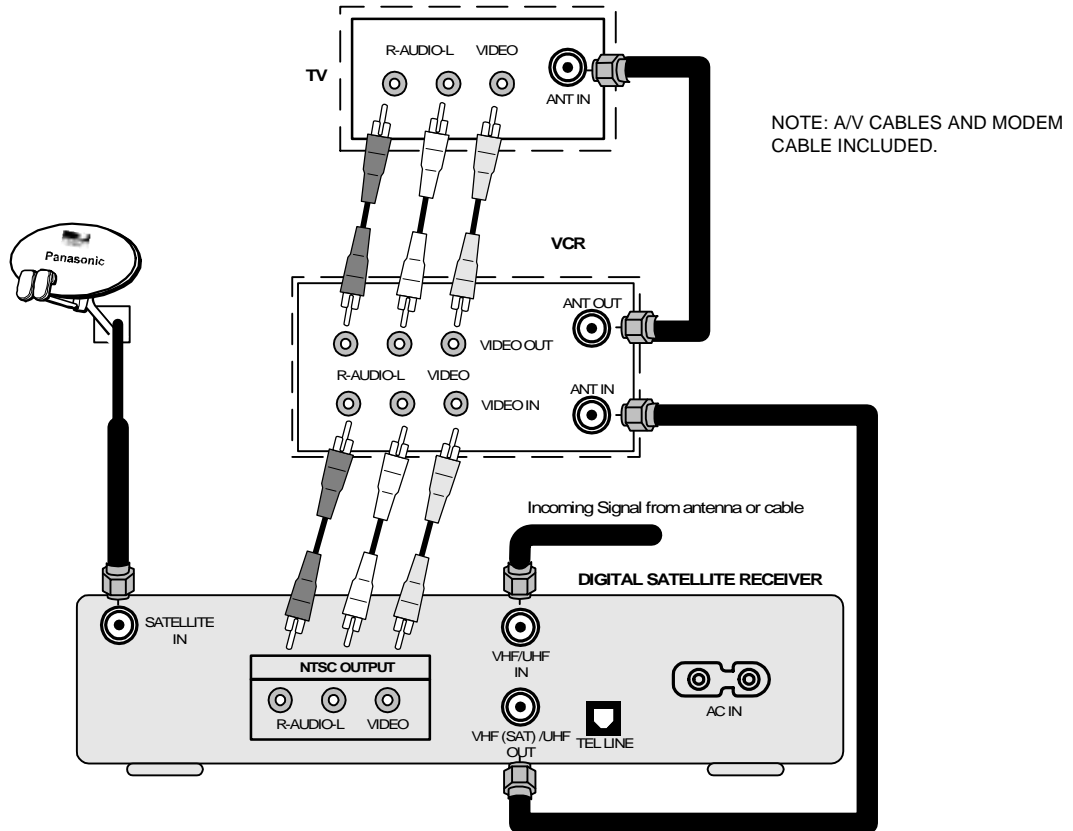

VCR SETUP

Procedure

- Connect video cable from the video output jack on the Digital Satellite Receiver to the video input jack on the VCR.
- Connect audio cables from the left and right audio output jacks on the Digital Satellite Receiver to the left and right audio input jacks on the VCR.
- Connect video cable from video output jack on the VCR to video input jack on TV.
- Connect the audio out cables from the audio output jacks on the VCR to the audio input jacks on the TV.

To record off-air programming

- Turn off satellite receiver or press **TV/SAT** button to toggle. Tune the VCR to desired channel and push record button on the VCR to start recording

Note: *This Digital Satellite Receiver incorporates an anticopy process technology that is protected by U.S. patents and other intellectual property rights measures. The anticopy process is licensed for non-commercial, home use only. Reverse engineering or disassembly is prohibited.*

Step 2. Turning Digital Satellite Receiver On

Procedure

- Press the Remote Control SAT mode button .
- Press the **POWER** button.

Note: Monitor/TV should also be turned on.

Step 3. Roller Guide Menu™

Press the **MENU** button to display the **Roller Guide Menu***. Press the **▲** or **▼** arrow on the **ACTION** button to rotate the Roller Guide. Press the **◀** arrow on the **ACTION** button to exit the Roller Guide Menu.

Panasonic

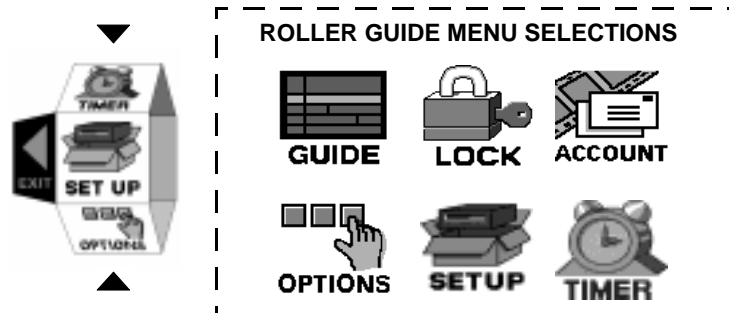

▲▼ for more features
Press ACTION to enter.

Note: To exit the Roller Guide Menu, press the **◀** arrow on the **ACTION** button, press the **MENU** button or press the **EXIT** button on the remote control.

Step 3a. ACTION / Navigation Button

Press **ACTION** to select the Roller Guide Menu item. Press the **▲** or **▼** arrows to highlight sub menus. Press the **▶** arrow to select features. Press the **▲** or **▼** arrows to scroll through options within a feature. Press the **◀** arrow to return to main menu items.

Remote ACTION / Navigation Button



Remote Control

POWER

Press to turn ON and OFF.

ACTION

Press to access sub menus or display Main Menus.
Press to activate wink enabled transactions (available in the future).

MENU

Press to access Roller Guide Menu.

INFO

Press to display time, channel banner, and other options.

"0" ~ "9"

Press numeric keypad to select any channel.

R-TUNE/JUMP

Press to switch to previously viewed channel or program.
Press to skip (jump) the Guide 24 hours ahead.



EXIT

Press to exit SAT Guide or DVD menu.

GUIDE

Press to select STB Guide or DVD menu.

TV/SAT TV/VCR

Press to select VIDEO inputs in TV mode.
Press to switch between TV and SAT in SAT mode or to switch between TV and VCR in VCR mode.

SAT VCR DVD TV

Press to select remote operation mode.

PROG (Program) / MUTE







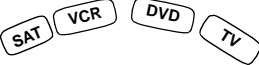
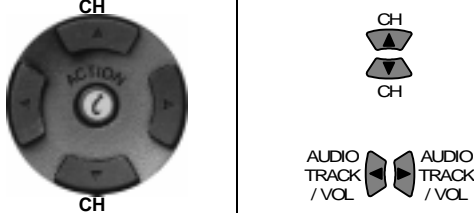

Press to enter the 2-digit minor number in a compound channel number.
Press to mute TV audio.

CH / PAGE







Press to select Page up/down, next/previous channel or Slow+ / Slow-

EUR511515

Remote Control Functional Key Chart

Key	Component	Function
	ALL COMPONENTS	Turn components On and Off
	ALL COMPONENTS	Component mode selection for Remote Control
	TV SAT VCR DVD	<p>Channel up/down Up navigation Down navigation</p> <p>Left and right navigation Exit Roller Guide Menu Select and adjust features Select audio tracks</p>
	TV SAT DVD	<p>Roller Guide Menu Main menu selections Select Activates wink enabled transactions (available in the future)</p>
	SAT DVD TV	Roller Guide Menu Menu
	TV VCR DVD SAT	On screen display SAT Program Info
	SAT	Exit Menus
	SAT	Guide
	TV SAT SAT DVD	<p>Previous channel Skips the GUIDE 24 hours ahead Title</p>
	SAT TV VCR DVD	<p>Press to enter the 2- digit minor number in a compound number. Mute TV audio</p>
	VCR	Record

Remote Control Functional Key Chart

Key	Component	Function
REW 	DVD VCR	Skip / Search Rewind Rewind
PLAY 	VCR DVD	Play
FF 	DVD VCR	Skip/Search Fast Forward Fast Forward
STOP 	VCR DVD	Stop
TV / SAT TV / VCR 	TV SAT VCR	Selects Video inputs Switch between TV and SAT Switch between TV and VCR
PAUSE 	DVD VCR	Still / Pause Pause
CH / PAGE 	SAT VCR DVD	Page up/down Channel up / down Slow +/-
① ② ③ ④ ⑤ ⑥ ⑦ ⑧ ⑨ ⑩	TV SAT VCR DVD CD	Selects channel number Selects code Selects track

Battery Installation

Incorrect installation can cause battery leakage and corrosion that will damage the Remote Control.

Use two AA batteries:

Remove the battery cover by pushing in near the arrow and sliding the cover back.

Install batteries matching (+) and (-) polarity signs.

Replace the battery cover.

Precautions

- Replace batteries in pairs.
- Do not mix battery types (zinc carbon with alkaline).
- Do not recharge, short-circuit, heat, burn, or disassemble batteries.

Special Remote Buttons

MENU button

The **MENU** button is used to enter and exit the Roller Guide Menu system. Each time the **MENU** button is pressed, the Roller Guide will appear on and disappear from the viewing screen.

INFO button

The **INFO** button lets you view Satellite program display and other on-screen displays when you are in TV, VCR or DVD operating modes.

GUIDE button

The **GUIDE** button lets you bring up the Satellite guide.

TV/SAT / TV/VCR button

The **TV/SAT** button lets you switch between TV and satellite programming.
The **TV/VCR** button lets you switch between TV and VCR programming.
While in **TV** mode, this button lets you select TV video inputs.

R-TUNE/JUMP button

In TV or SAT mode, the **R-TUNE/JUMP** button quickly switches between two channels or programs.

If you press this button while viewing the Program Guide, the Guide will skip **24** hours ahead. Each time you press this button, the Guide will jump 1 day ahead. You can jump (skip ahead) the Guide three times. At the fourth try, the Guide will display the original screen.

In DVD mode it will let you select titles.

PROG/MUTE button

In TV, VCR or DVD mode, the **PROG/MUTE** button mutes the audio.

In SAT mode, press the **PROG/MUTE** button to enter the 2 digit minor number in a compound number.

CH/PAGE button

In SAT mode, press **PAGE ▲** or **PAGE ▼** button to scroll up or down through the Program Guide quickly.

In TV or VCR mode, press to change channels.

PROGRAMMING THE REMOTE CONTROL

Programming the Remote Control

The Universal Remote Control can be programmed to operate many manufacturers' components using the component function buttons for TV, VCR, DVD. Follow the procedures for programming your Remote Control with and without codes for the component. Determine the manufacturer of the component and look in the table for the code.

Programming With Code

- Confirm that the external component is plugged in and is turned on.
- Turn the component off.
- Press the **ACTION** and **POWER** button, together, for **at least 5 seconds** and then let go of the buttons.
- Press appropriate component button (TV, VCR, DVD) on the Remote Control.
- Enter the 3-digit component code using the Remote Control numeric keypad (**0 ~ 9** buttons). If a proper code was entered, the mode button will blink twice and go out.
- Press the Remote Control **POWER** button to test the component. If the procedure was successful, the component will turn on.

 Unsuccessful Code
If the component does not operate with the Remote Control, repeat the procedure using another code. (Some brands have multiple codes.) If an incorrect code is entered, or if the procedure takes longer than 30 seconds, the programming will fail.

Programming Without Code

This procedure searches all codes and is called the "sequence method".

- Confirm that the external component is plugged in and is turned on.
- Turn the component off.
- Press the **ACTION** and **POWER** button, together, for **at least 5 seconds**, and then let go of the buttons.
- Press appropriate component button on the Remote Control.
- Press the ► button to move forward to the next code. Press the ◀ button to move backward.
- Press the Remote Control **POWER** button to test the component. If the procedure was successful, the component will turn on.

Note: Repeat the preceding two steps until the component code is found. It may take many attempts before the correct code is found.

- After the code is found, press the **ACTION** button to store the code.

Component Codes

The Universal Remote Control is capable of operating many component brands after entering a code. Some components may not operate because memory is limited. The Universal Remote Control does not control all features in all models.

Codes for TV

Brand	Code
Akai	104
Centurion	104
Daewoo	104, 106
Emerson	104, 108, 109, 110, 120
Fisher	111
GE/Panasonic/ Quasar	101
GE/RCA	112
Hitachi	113
JVC	114
Magnavox	104, 115, 116
Marantz	117

Brand	Code
Panasonic	100, 101, 102
Pioneer	101, 107, 118
Proscan	104, 112, 119
Quasar	101, 103
Radioshack	104, 112, 117, 120
RCA	104, 112, 119, 121, 122
Samsung	104, 123
Sears/Toshiba	104, 107, 111, 112, 115
Sharp	120, 124
Sony	125
Zenith/Inteq	126, 127

Codes for DVD

Brand	Code
Denon	100
Ferguson	101
JVC	108, 109
Mitsubishi	105
Nordmende	101
Panasonic	100
Philips	103
Pioneer	102

Brand	Code
RCA	101
Saba	101
Samsung	110
Sharp	108
Sony	104
Thomson	101
Toshiba	103
Yamaha	100
Zenith	107

Write the code numbers for your components in the space provided below. This will serve as a reference when you need to reprogram your remote control.

Television	DVD	VCR
<input style="width: 30px; height: 20px;" type="text"/> <input style="width: 30px; height: 20px;" type="text"/> <input style="width: 30px; height: 20px;" type="text"/>	<input style="width: 30px; height: 20px;" type="text"/> <input style="width: 30px; height: 20px;" type="text"/> <input style="width: 30px; height: 20px;" type="text"/>	<input style="width: 30px; height: 20px;" type="text"/> <input style="width: 30px; height: 20px;" type="text"/> <input style="width: 30px; height: 20px;" type="text"/>

Codes for VCR

Brand	Code
Admiral	135
Aiwa	132
Akai	129, 114, 115, 116
Audio Dynamic	111, 139
Bell & Howell	105, 113
Broksonic	120, 126
Canon	123, 125
CCE	143
Citizen	106
Craig	105, 106, 129
Curtis Mathes	124, 127, 145
Daewoo	101, 124, 143
DBX	110, 111, 139
Dimensia	145
Emerson	103, 118, 119, 120, 125, 126, 141, 143
Fisher	105, 107, 108, 109, 113
Funai	120, 126, 127, 134
GE	124, 133, 145
Go Video	137, 149, 150, 151
Goldstar	106
Gradiente	134
Hitachi	100, 123, 127, 145
Instant Replay	123, 124
Jensen	139
JVC	110, 111, 134, 139
Kenwood	106, 110, 111, 139
LXI	100, 105, 106, 107, 108, 109, 127
Magnavox	123, 124, 131
Marantz	110, 111, 139
Marta	106
Memorex	109, 124
MGA	138, 140, 141, 147, 148
Minolta	100, 145
Mitsubishi	138, 140, 141, 147, 148
Multitech	104, 127, 147
NEC	110, 111, 134, 139
Olympic	123, 124
Optimus	106, 121, 128, 135

Brand	Code
Orion	120, 126
Panasonic	121, 122, 123, 124
Penney	100, 105, 110, 111, 124, 139, 145
Pentax	100, 111, 145
Philco	120, 123, 124, 126, 127, 131
Philips	123, 124, 131, 173
Pioneer	123
Proscan	100, 101, 102, 123, 124, 131, 133, 145, 146
Quasar	121, 122, 123, 124
Radio Shack	105, 109, 124, 127, 133, 136, 140
RCA	100, 102, 123, 124, 131, 133, 145, 146
Realistic	105, 109, 124, 127, 136, 140
Samsung	102, 104, 133, 137
Sansui	120, 126, 139, 152
Sanyo	105, 109, 113
Scott	102, 104, 109, 120, 126, 138, 140, 147, 148
Sears	100, 105, 106, 107, 108
Sharp	135, 136
Shintom	117
Signature 2000	127, 135
Singer	117
Sony	128, 129, 130
SV2000	127
Sylvania	123, 124, 127, 131
Symphonic	127
Tashiro	106
Tatung	110, 111, 139
Teac	110, 111, 127, 139
Technics	121, 122, 123, 124
Teknica	112, 124, 127
Toshiba	146
Vector Research	111
Yamaha	105, 110, 111, 139
Wards	106, 109, 135, 136, 144
Zenith	106, 144

Special Features of Digital Satellite Receiver

Impulse Pay Per View (IPPV)

You must connect your phone line to the Digital Satellite Receiver to receive pay per view (PPV) service offered by DIRECTV. Connecting the phone line permits you to use the IPPV feature, which allows event purchases without calling a CSR (Customer Service Representative). If you decide against connecting to your phone line, you must call the CSR to purchase events, such as pay per view movies*. DIRECTV refers to such CSR assisted purchases as OPPV (Order ahead pay per view).

When OPPV or subscription authorization changes (e.g., customer cancels the movie purchases), the Digital Satellite Receiver will reflect that change immediately. The Digital Satellite Receiver will display a message, identifying the reason for the authorization status change.

The Digital Satellite Receiver has the ability to allow you to purchase a PPV event offered by DIRECTV. When the Digital Satellite Receiver is tuned to an IPPV channel, (video may or may not be displayed, depending upon whether the PPV event has started) the following message is displayed on the screen.

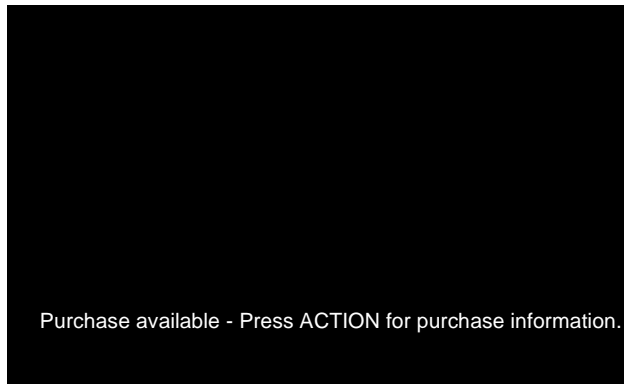

IPPV message with video in the background

*An additional fee applies to all pay per view phone-in orders.

SPECIAL FEATURES OF DIGITAL SATELLITE RECEIVER

If you press the **ACTION** key, the PPV window will be displayed. Once a PPV event starts, video and audio could be displayed for 5 minutes into the PPV event. After 5 minutes have elapsed, video and audio are removed from the screen. You can purchase the current PPV event up to 30 minutes after an event has started. If the PPV event passes the 30 minutes from the event starting time, a message will be displayed and video will be blocked as shown below and you will not be able to purchase the program.



Impulse pay per view: Icons

The Channel Banner will contain several icons that are displayed only when the feature is available and is supported by the Digital Satellite Receiver.

The following figure depicts the PPV window. If you decide to buy the event or buy and record the event, another confirmation window is displayed, requiring you to confirm the purchase before completing the transaction.

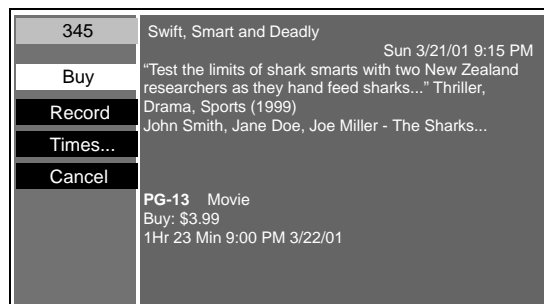

PPV Window

SPECIAL FEATURES OF DIGITAL SATELLITE RECEIVER

You will be given a choice of whether you wish to Purchase (OK) or Cancel this PPV event, as shown below.

345	Swift, Smart and Deadly	Sun 3/21/01 9:15 PM
Buy	"Test the limits of shark smarts with two New Zealand researchers as they hand feed sharks..." Thriller, Drama, Sports (1999)	
Times	John Smith, Jane Doe, Joe Miller - The Sharks...	
Exit	CC	PG-13
	MSNBC Buy: \$3.99 1 Hr 23 Min 9:00 PM 03/22/01	
Do you want to purchase this event?		
<input type="button" value="Cancel"/> <input type="button" value="OK"/>		

PPV Confirmation Window (Buy Event)

345	Swift, Smart and Deadly	Sun 3/21/01 9:15 PM
Buy	"Test the limits of shark smarts with two New Zealand researchers as they hand feed sharks..." Thriller, Drama, Sports (1999)	
Record	John Smith, Jane Doe, Joe Miller - The Sharks...	
Times	CC	PG-13
Exit	MSNBC Buy: \$2.99 Record: \$4.00 1Hr 23 Min 9:00 PM 3/22/01	
Do you want to purchase this event?		
Be sure that Your VCR is set to record.		
<input type="button" value="Cancel"/> <input type="button" value="OK"/>		

PPV Confirmation Window (Buy and Record Event)

You can also select other time to view this event, as shown below. After you have selected a different time, the PPV confirmation screen is displayed.

345	Swift, Smart and Deadly	9:15 PM	Sun 3/21/01
Buy	Ch. 345	9:00 PM	11/28/01
Record	Ch. 345	9:00 PM	11/29/01
Times	Ch. 345	11:00 PM	11/29/01
Cancel	Ch. 345	9:00 PM	11/30/01
	Ch. 345	11:00 PM	11/30/01
	Ch. 345	9:00 PM	12/01/01
Press ACTION for purchase information			

PPV Other Times Window

SPECIAL FEATURES OF DIGITAL SATELLITE RECEIVER

Software Upgrade Messages

The Digital Satellite Receiver has the ability to receive download replacement software. This will allow the Digital Satellite Receiver software to be upgraded. The Digital Satellite Receiver will prompt you when an update is required. You have the ability to reject or cancel the update at this time. However, this notification will repeatedly occur until you have upgraded the software.

The Digital Satellite Receiver will first display and update message when the unit is in the tuning mode. This OSD will allow you to begin or cancel the software download, as shown below.



Software Upgrade Message

If the user elects to download software when prompted, an approximate time remaining for download will be displayed, as shown below.

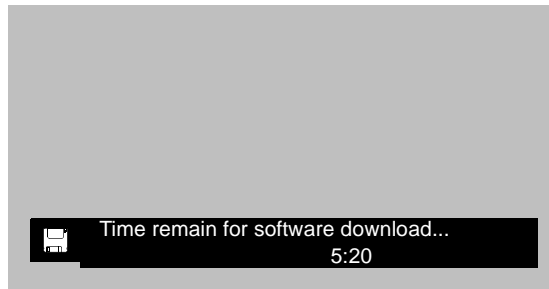

Time Remain for Software Download

If you elect to cancel the download, the user will be prompted again to perform this download every time the user turns ON the Digital Satellite Receiver. This software download message will occur, until the Digital Satellite Receiver unit has been updated.

Roller Guide Menu™

Press the **MENU** button on the Remote Control to display the **Roller Guide Menu™**. Press the ▲ or ▼ arrow to rotate the Roller Guide. Press the **ACTION** button to enter a category submenu screen, where the options for that category can be changed. Press the ◀ arrow to exit the Roller Guide Menu.

The Roller Guide screen is the entry point for all menu operations on the system. The first time that the Digital Satellite Receiver is powered ON, the SET UP category is the default state. The main menu provides access to the following categories:

- Guide
- Lock
- Account
- Options
- Setup
- Timer

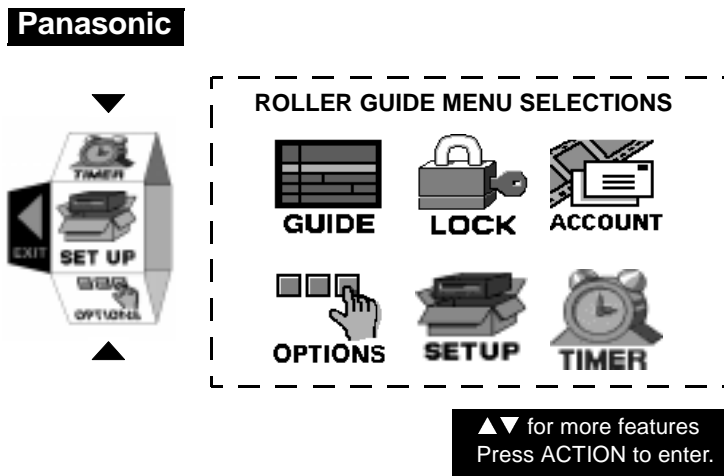

Note: To exit the Roller Guide Menu, press the ◀ arrow on the **ACTION** button or press the **MENU** button.

ACTION / Navigation Button

Press the **ACTION** button to select main menu items. Press the ▲ or ▼ arrows to highlight sub menus. Press the ▶ arrow to select features. Press the ▲ or ▼ arrows to scroll through options within a feature. Press the ◀ arrow to return to main menu items.



Remote **ACTION** / Navigation Button





**Roller Guide Menu is a trademark of Panasonic Consumer Electronics Company. U.S. patent pending.*

Roller Guide Feature Chart



Roller Guide Feature Chart

MENU	DESCRIPTION
 SETUP	SET UP
Satellite Setup	<ul style="list-style-type: none"> <input type="checkbox"/> Dish Type - Lets you choose Oval or Round dish. <input type="checkbox"/> Sat. Ports - Selects up to 4 nominal satellite configuration or lets you perform auto-detection. The user can select: <ul style="list-style-type: none"> • Dish Type : Oval or Round • Satellite A and B • Satellite A, B, and C • Auto Configuration <input type="checkbox"/> Dish Position - Digital Satellite Receiver displays the proper co-ordinates for the particular zip code. <input type="checkbox"/> Signal Meter - Shows the strength of the selected satellite signal.
MONITOR	<ul style="list-style-type: none"> <input type="checkbox"/> TYPE <ul style="list-style-type: none"> • 4:3 (default setting) for conventional TV screen. • 16:9 for wide screen.
System Test	<ul style="list-style-type: none"> <input type="checkbox"/> System Test - Invokes system test available for Satellite Input.
Access Card	<ul style="list-style-type: none"> <input type="checkbox"/> Access card - Remapping of information. (Use only when instructed by DIRECTV.)
TV Output	<ul style="list-style-type: none"> <input type="checkbox"/> TV Setup - Lets you set the RF output of the Digital Satellite Receiver to Ch 3 or 4 so that you can connect the output to the ANT IN jack of your television.
 GUIDE	GUIDE
	<p style="text-align: center;"><i>Guide provides Channels and Program information to the user.</i></p> <p>Note: <i>The Guide is active in the SAT mode only.</i></p>

Roller Guide Feature Chart (Cont.)

MENU	DESCRIPTION
 TIMER	TIMER
<p>TIMER 1 TIMER 2 TIMER 3 TIMER 4 TIMER 5 TIMER 6 TIMER 6 TIMER 7 TIMER 8</p>	<p><input type="checkbox"/> MODE - Select one of the following:</p> <ul style="list-style-type: none"> • OFF (default setting) to disable timer. • ON to turn on Digital Satellite Receiver only. (Must turn TV on to view the event). • Repeat (weekly or once) <p><input type="checkbox"/> DAY - Select the day of the week to activate timer.</p> <ul style="list-style-type: none"> • START - Select time for timer to start. • STOP - Select time for timer to stop. <p><input type="checkbox"/> CHANNEL - Select the channel for STB to tune to at appropriate time.</p> <p>Note: <i>Whenever the antenna or cable mode is changed, Timers will revert back to default settings.</i></p>
 LOCK	LOCK
Unlock	<p><input type="checkbox"/> Unlock - Lets you unlock or lock the Digital Satellite Receiver.</p>
Movie Limits	<p><input type="checkbox"/> Movie Limits- Lets you block out movies based on MPAA ratings.</p>
TV Limits	<p><input type="checkbox"/> TV Limits- Lets you block out TV programs based on TV Parental Guide ratings.</p>
Ch Locks	<p><input type="checkbox"/> Ch Locks - Lets you lock satellite channels from being displayed. Need to enter password to view these channels.</p>
Spending	<p><input type="checkbox"/> This feature allows the user to control the amount per event. If the amount is below the event cost, you won't be able to view the event.</p>
Password	<p><input type="checkbox"/> Password - A password, the user must provide in order to perform a function.</p>

Roller Guide Feature Chart (Cont.)

MENU	DESCRIPTION
 ACCOUNT	ACCOUNT
Future Purchases	<input type="checkbox"/> Future purchases - Displays PPV events purchased, but not aired. Also lets you to cancel a PPV event.
Past purchases	<input type="checkbox"/> Past purchases - Lets you review PPV purchased events. Displays CAM slot numbers when Past purchase data is highlighted.
Messages	<input type="checkbox"/> Messages - Displays message sent to the Digital Satellite Receiver from DIRECTV over the Satellite Link.
 OPTIONS	OPTIONS
Audio	<input type="checkbox"/> Audio - Selects the Format and Language preferences.
Clock	<input type="checkbox"/> Clock - Lets you configure the system clock for DIRECTV. (Clock is set automatically when DIRECTV Service is activated.)
Favorites	<input type="checkbox"/> Favorites - Lets you add or delete channels from the favorite list.
About	<input type="checkbox"/> About - Displays various information about the Digital Satellite Receiver including the model number, serial number, and the current software version.
Upgrades	<input type="checkbox"/> Upgrades - Displays Software upgrade information.
Features	<input type="checkbox"/> Features - Displays the feature list of the Digital Satellite Receiver.

Roller Guide Menu Operations

Setup

To help you with the initial set up of the Digital Satellite Receiver, the Setup menu is displayed automatically when the Digital Satellite Receiver is turned on for the first time. A setup wizard will help guide you through the procedure of setting up the proper satellite configurations, dish type, monitor and TV output setup. The Setup options will assist you to configure the DIRECTV signals so that the unit can receive the desired video signals. Following are requirements that are needed to receive DIRECTV® programming.

Setup Options

Option	Required for DIRECTV
Sat. Setup	Yes
Monitor	Yes
System Test	Yes
Access Card	Yes
TV Output	Yes

Setup : Satellite Setup – Dish Type

This menu lets you select the type of satellite dish that you have installed. If you have round dish, select Round and if you have oval shaped dish, select Oval.

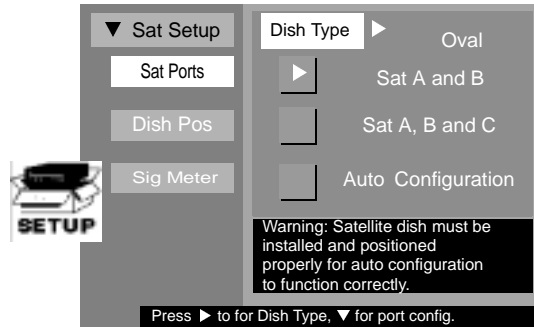

Satellite Setup – Dish Type

Procedure

- Press ► button to highlight Dish Type.
- Press ► button to change Dish Type.
- Press ▲▼ to select either Round or Oval (Round is the default setting).
- Press **ACTION** button to save the selection.
- Press ◀ button once to return to Sat. Setup menu.

ROLLER GUIDE MENU OPERATIONS

Setup : Satellite Setup – Sat. Ports

After you have selected the Dish type, you can choose the satellite port configuration. If Round dish is selected, then only the Satellite A configuration is available. If you selected Oval shaped dish, you can choose from the three configurations: Auto configuration, Sat. A and B, and Sat. A, B and C. If you select Auto configuration operation, the navigation buttons are disabled until the Digital Satellite Receiver completes the auto configuration.

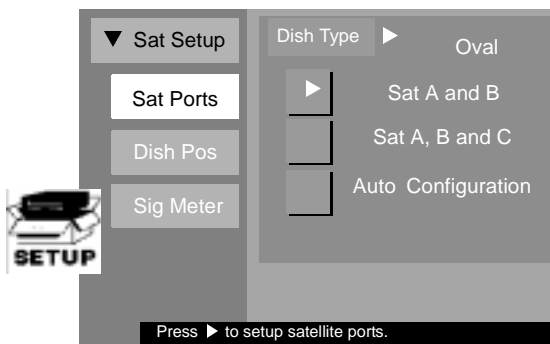

Satellite Setup – Sat. Ports Screen

Note: Please also refer to the installation manual for the satellite dish antenna for proper mounting procedure.

Procedure

- Press ► and ▼ button to setup satellite ports configuration.
- Press ▲▼ buttons to navigate among the choices - Sat. A and B, Sat. A, B and C, and Auto Configuration.
- Select Sat A & B and Auto Configuration, if you have Oval shaped dish.
- Press **ACTION** button to save the selection.
- Press ◀ button to return to Sat. Setup menu.

Setup : Satellite Setup – Dish position

This screen allows you to position your Satellite antenna by having the Digital Satellite Receiver provide approximate values for elevation, azimuth and tilt (marked in degrees), after the you have entered your 5-digit zip code.

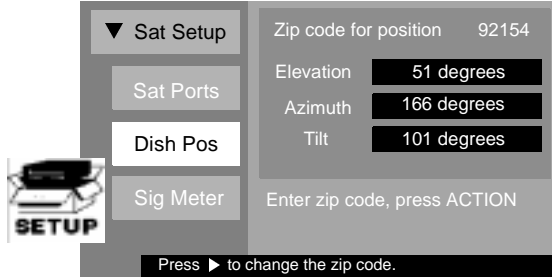

Dish position screen

Procedure

- In Sat Setup menu, press ▲▼ buttons to highlight Dish Position. Dish Position sub menu is displayed.
- Press ► button to enter your Zip code. Use the numeric keys on the Remote Control to input your zip code numbers. Press ► button to move to the next position.
- Press **ACTION** button to enter the new zip code. Elevation, Azimuth and Tilt are automatically displayed after you press the **ACTION** button.
- This information should be used to properly align and position the satellite antenna. These values are approximations. Proper alignment should also be verified by using the signal strength meter.

Setup : Satellite Setup – Signal Meter

Since the Digital Satellite Receiver is capable of receiving satellite programming from multiple DIRECTV satellites, the user has the ability to choose one of 3 supported satellites to receive signal strength and is primarily used during the system set-up procedure. The Digital Satellite Receiver signal meter uses a horizontal digital signal strength percent bar meter. The user will have the ability to select which transponder (1 to 32) they wish to measure the signal strength. The following is the signal meter screen.

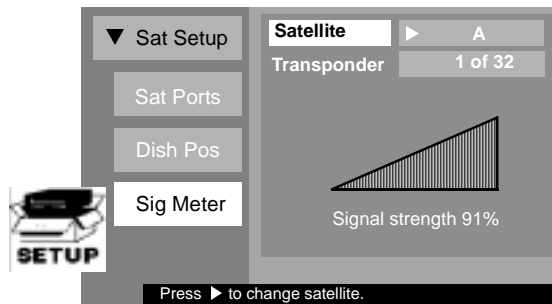

Signal Meter Screen

Procedure

- In the Sat. Setup menu, press ▼ button to highlight Signal Meter. Sub- menu is displayed.
- Press ► to highlight Satellite.
- Press ► to change Satellite
- Press ▲▼ buttons to select Satellite A, B or C.
- Press **ACTION** to enter the selection.
- Press ▼ button to highlight Transponder.
- Press ► button then ▲▼ buttons to choose one of 32 transponders. Select the transponder that gives you a signal strength of 85%.
- Press ◀ two times to return to SETUP menu.

ROLLER GUIDE MENU OPERATIONS

Setup : Monitor

The monitor menu allows you to match your monitor/receiver type. You can choose between two monitor types: 16:9 or 4:3 aspect ratio.

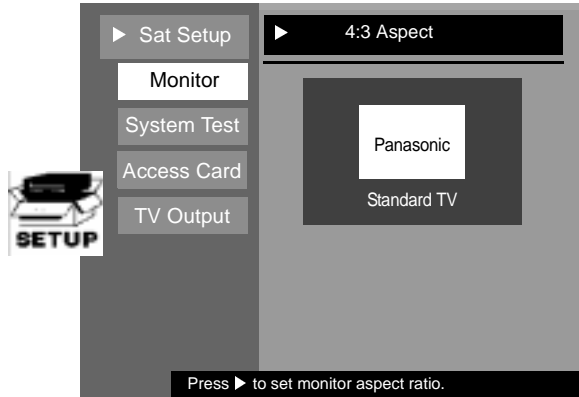

Setup : Monitor Screen

The following table shows the icon and messages displayed for each of the monitor types.

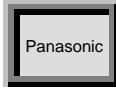
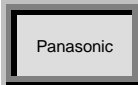
Type	Picture Icon	Message
4:3		"Standard TV"
16:9		"DTV Wide Screen"

Procedure

- In SETUP menu, press ▼ button to select Monitor.
- Press ► button to highlight Monitor.
- Press ► button to change monitor aspect ratio.
- Press ▲▼ buttons to select 4:3 or 16:9.
- Press **ACTION** button to save the selection.

Setup : System Test

The System Test menu allows you to invoke a system test which perform a check of the following subsystems.

Component	Requirement	Display Information
Tuning Test	This attempts to tune to an known frequency.	Status: PASSED or FAILED
Signal Test	This tests the signal strength.	Status: PASSED or FAILED
Phone Test	This checks the modem operational status.	Status: PASSED or FAILED
Access Test	This checks the Access Card function.	Status: PASSED or FAILED
Card ID	Card is installed in TZ-DRD100	Serial # xxxx-xxxx-xxxx

Note: System test is only available for Satellite input.

The following screens show the system test screen and the system test in progress.

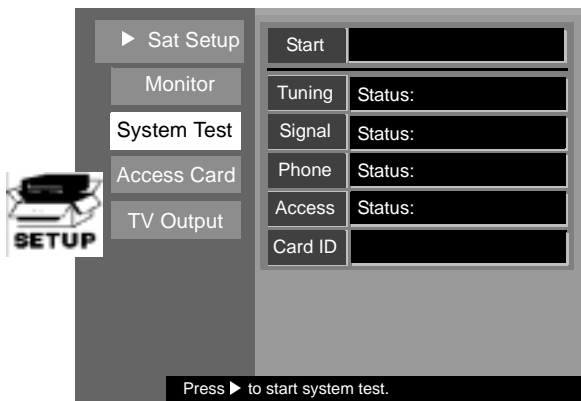

System Test Screen

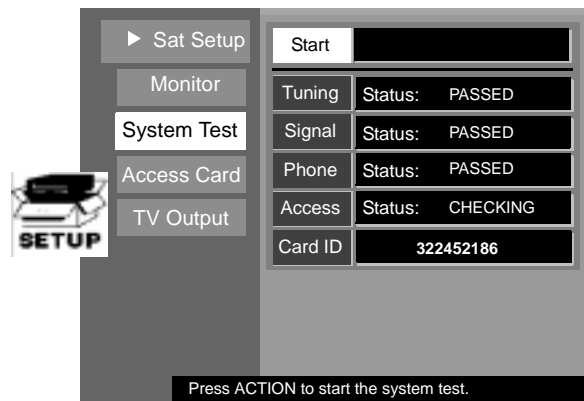

System Test Screen (System Test in progress)

Procedure

- In SETUP menu, press ▲ or ▼ button to highlight System Test.
- Press ► button to highlight Start.
- Press **ACTION** button to start the System Test.
- Press ◀ button to return to Setup Menu.

ROLLER GUIDE MENU OPERATIONS

Setup : Access Card

The Setup screen allows you to setup a new access card. You can transfer existing access card information to the new access card. This procedure is called “chaining”. When you press the ACTION button while the Access Card is highlighted, a series of Conditional Access driven menus will be displayed. This will direct you on what procedures to perform.

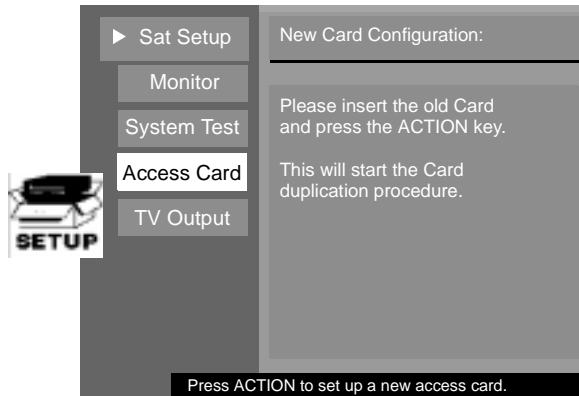

Access Screen (Entry Point)

Procedure

- In SETUP menu, press ▲ or ▼ buttons to highlight Access Card. Follow the directions displayed on-screen.
- Press **ACTION** button to setup a new access card.
- Press ◀ button to return to Rollerguide menu.

Note: *This procedure can only be used in the case where a new card is provided by DIRECTV and is different from the card that comes with the unit.*

TV Output

This menu lets you set the RF output of the Digital Satellite Receiver to either CH 3 or CH 4. You can connect the Digital Satellite Receiver to your television, even if your TV does not have video inputs.

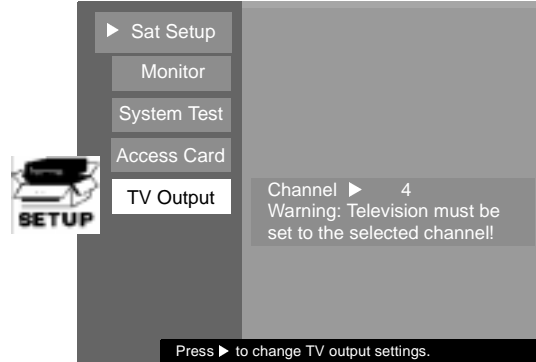

TV Output Screen

Procedure

- In SETUP menu, press ▲ or ▼ buttons to highlight TV Output.
- Press ▶ to change the TV output settings.
- Press ▲ or ▼ to select CH 3 or 4.
- Press ACTION button to save the selection.

Note: *Prior to adjusting this feature, make sure that your TV is set either CH 3 or 4. TV output channel that you select in the SETUP menu should be the same as the television.*

ROLLER GUIDE MENU OPERATIONS

Guide

The Advanced Program Guide™ (APG) is a key feature of the Digital Satellite Receiver. The Guide enables you to browse through a large number of programs and provides useful information upon user request, as shown below.



Guide: Full Screen

If the user tries to access the Guide while it is acquiring data from the satellite signal, a message will be displayed showing the graphical countdown clock of when the Guide will be ready for display.

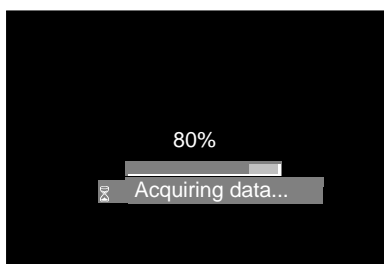

Guide : Acquisition Delay window

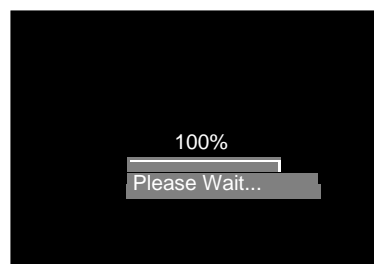

100% Acquisition Window

Tuning to a Program

You can select a program by highlighting the program in the Guide and pressing **ACTION** button on the remote control or by directly entering the desired channel number using the remote control number keys and pressing the **ACTION** button.

Guide : Channel List

The guide will display channel(s) that are either in the “ALL CH” or “FAV CH” mode. The Digital Satellite Receiver default mode is “ALL CH”. The user can switch the mode through a button in the channel banner area of the guide.

Guide : “ALL CH” mode

“All CH” mode - APG will contain all guide ‘permitted channels’.

Guide : “FAV CH” mode

“FAV CH” - APG will contain all guide defined ‘permitted channels’ except the channels the user chose to remove. While navigating the guide in the “FAV CH” mode, entering a number for a hidden channel (channels that were removed by the user are referred to as hidden channel) the next highest non-hidden channel is selected.

Procedure

- Press **GUIDE** button on the remote control to display the APG.
- Press **INFO** button on the remote control.
- Press **▼** button to highlight ALL CH or FAV CH.
- Press **ACTION** button to toggle back and forth.

Picture in Guide

When in Guide, the Picture in Guide feature will display a video panel of the currently tuned channel on the top left corner of the screen. When Guide screen is active, pressing the GUIDE key will cause the guide layout to toggle between the Standard and Picture in Guide screen. Press the INFO key to display the Category screen. If you press the INFO or GUIDE button while in Category Search mode, the Category Search will terminate and the previous Guide screen (Standard or Picture in Guide) will be displayed. Press EXIT button to exit the Guide screen.

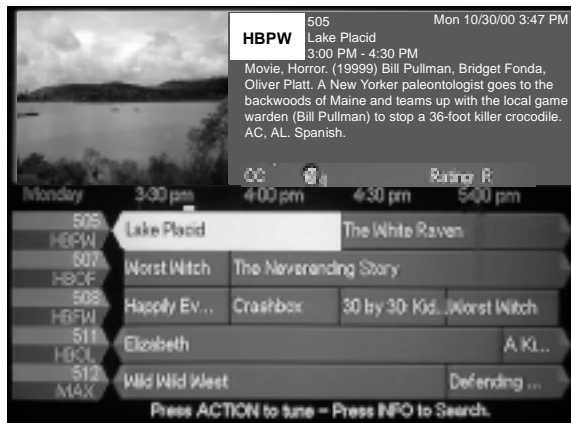

ROLLER GUIDE MENU OPERATIONS

Searching the Guide by Categories

The APG is capable of displaying information according to the categories that you have selected. For example, if you select Movies category, then only those channels broadcasting movies are displayed in the guide. You can also select sub-categories of the category you selected.



Guide: Search Screen



Guide: Search Screen - Sub categories

Procedure

- Press **GUIDE** button to display the Guide screen.
- Press **INFO** button to display the Search Screen.
- Press **▼** button to highlight Search.
- Press **►** button to display categories.
- Press **▲** or **▼** button to highlight the desired category.
- Press **ACTION** button to start the search. If there are programs available in the category you selected, they will be listed in the guide.

Following is an example of Guide showing Movie channels only.



Guide : Direct Channel Entry

The APG has the ability to search for a channel based on the channel number. When the user presses a numeric key to enter in channel numbers, a channel entry area appears in the top left corner of the guide channel banner, as shown below.



Guide: Direct Channel Entry

Guide : Banner Description Icons

The Guide Banner will contain several icons that are displayed only when the feature is available and is supported by the Digital Satellite Receiver. The following table and figure shows the appearance of these icons.

Icon Name	Icons Description	Icon Appearance
Messages	Indicates unread messages.	
Lock	Indicates that the channel is locked due to either limits on spending or by content advisory.	
Alternate Audio	Indicates that the program has multiple audio tracks.	
Closed Captioning	Indicates that the program has Closed Captioning.	CC

ROLLER GUIDE MENU OPERATIONS
Guide (Cont.)

The following figure shows the Banner components.

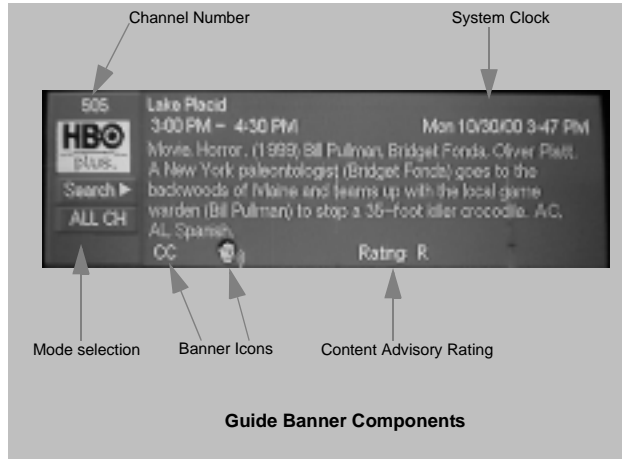

Guide : Banner Components

Guide : Grid

The guide grid shows information on 5 channels within 1.5 hour time span. The channel name can be highlighted by navigating to the left of the grid. Following is an example of the Channel Grid Components.

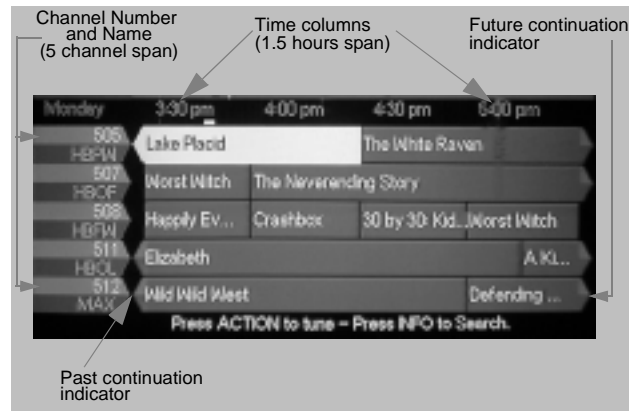

Guide : Grid Components

Lock

This Digital Satellite Receiver incorporates V-Chip technology to block the viewing of movies and television programs according to the rating category. There are 2 Content Advisory categories: MPAA (Motion Picture Association of America) and TV Parental Guidelines Ratings and are used as guidelines for blocking the programs.

Lock : Password

Before you can access the LOCK menu settings, you need to enter a 4 digit secret code.

Procedure

- In the Roller Guide menu, press the ▲▼ buttons to highlight the LOCK icon.
- Press **ACTION** button to display the LOCK menu.
- Press ► button.
- Use the numeric keypad to enter a four-digit secret code. *(Use a code that is easy to remember and record it in a safe place).*

Once you correctly enters the code, you will have access to the user profile as shown below.

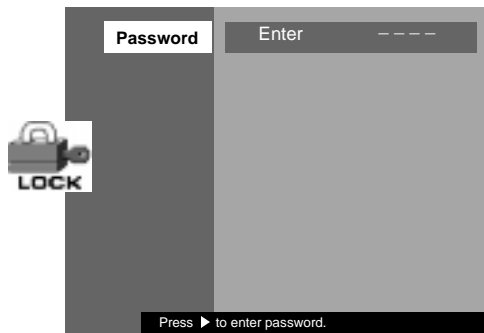

Lock : Password Screen

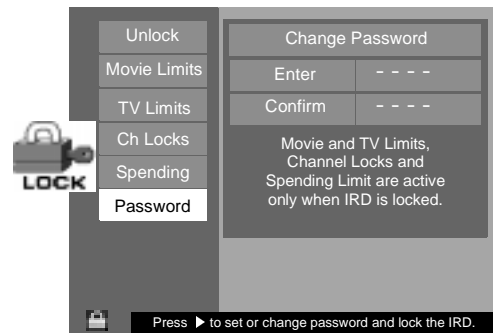

Lock : Change Password Screen

Once you gain access to the user profile, the user can have access to the following areas.

Settings	Description
Unlock	Lets you unlock and lock the Digital Satellite Receiver so that you can view the locked channels.
Movie Limits	This allows the user to set the movie ratings limit, according to MPAA.
TV Limits	This allows the user to set TV ratings limit.
Ch Locks	This allows the user to lock all satellite and non-satellite channels from being displayed or unlock all channels.
Spending	This allows the user to set the spending limit.
Password	The user can change the current password.

ROLLER GUIDE MENU OPERATIONS

Lock: Unlock

This menu lets you unlock the Digital Satellite Receiver so that you can view the locked channels after entering the password.

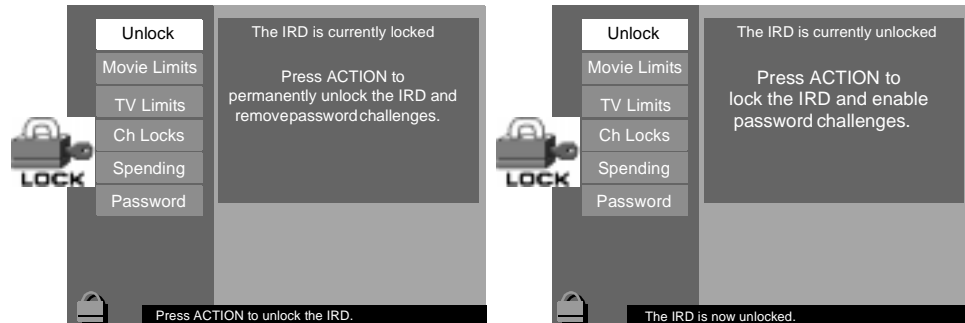

Unlock Screen

Procedure

- In the Roller Guide menu, press the ▲▼ buttons to highlight the **LOCK** icon.
- Press **ACTION** button to display the **LOCK** menu.
- Press **ACTION** button to unlock the Digital Satellite Receiver. The screen on the right will be displayed.

Lock : Movie Limits

The MPAA uses the standard movie ratings. The TV Parental Guidelines provides rating schemes of its own: age-based ratings, content-based ratings or combination of the two.

The following table and figure shows the MPAA ratings system.

MPAA Rating	Description
NR	Not Rated by MPAA
G	General Audience
PG	Parental Guidance Suggested. Some material may not be suitable for children.
PG-13	Parent Strongly Cautioned. Some material may be inappropriate for children under 13.
R	Restricted. Under 17 requires accompanying parent or guardian.
NC-17	No one 17 and under admitted
X	No one 17 and under admitted

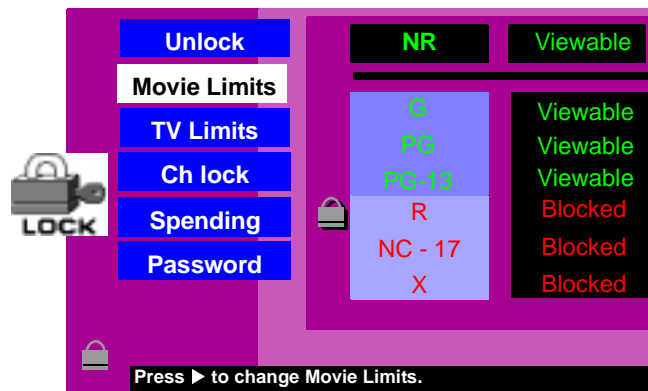

Lock : Movie Limits Screen

Procedure

- In the Roller Guide Menu, press ▲▼ buttons to highlight LOCK icon.
- Press ACTION button to display the LOCK menu.
- Press ▲▼ buttons to highlight Movie Limits.
- Press ► button to display the sub-menu.

Note: You will need to enter your password to change any ratings.

- Press ▲▼ buttons to move between different ratings.

ROLLER GUIDE MENU OPERATIONS

Lock : TV Limits

The TV Parental Guidelines has 7 levels of age-based ratings that the user can select. These 7 levels are split into 2 age-based groups: Youth Age-based Ratings and Guidance Age-based Ratings.

Some of these age-based ratings can also have content-based ratings, denoted as D (Dialog), L (Language), S (Sex) and V (Violence). Any non-rated program that does not provide Content Advisory information will be viewable. Following table shows the Age-based Ratings Selection.

Age-based Group	Age-based Ratings	Possible Content Selections
NR (Not Rated)	NA	<ul style="list-style-type: none"> Viewable Blocked
Youth	TV - Y	<ul style="list-style-type: none"> Viewable Blocked
	TV - Y7	<ul style="list-style-type: none"> (Fantasy) FV Viewable Blocked
Guidance	TV - G	<ul style="list-style-type: none"> Viewable Blocked
	TV - PG	<ul style="list-style-type: none"> D,L,S,V (all selected) Any combination of D, L, S, V
	TV - 14	<ul style="list-style-type: none"> D, L S, V (all selected) Any combination of D, L, S, V
	TV - MA	<ul style="list-style-type: none"> L, S, V (all selected) Any combination of L, S, V

Procedure

- In the Roller Guide Menu, press ▲▼ buttons to highlight LOCK icon.
- Press ACTION button to display the LOCK menu.

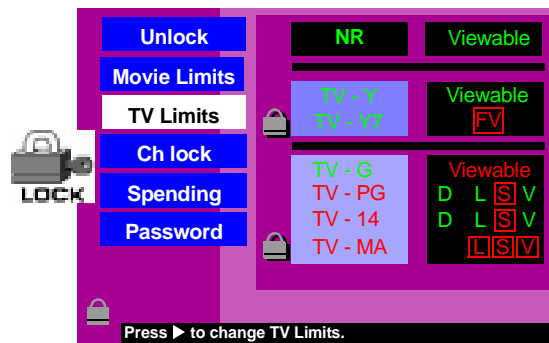

Lock :TV Limits Screen

- Press ▲▼ buttons to highlight TV Limits.
- Press ► button to display the sub-menu.

Note: You will need to enter your password to change any ratings.

- Press ▲▼ buttons to move between different ratings.
- Press ACTION button to activate or deactivate the rating level.

Lock : Ch Locks

The user can lock satellite channels from being displayed. To access these channels when channel surfing, the user is required to enter the 4 digit secret password.

Once the user has highlighted Sat Ch Lock or Non-Sat Lock Grid, the user will be able to easily “Unlock All” or “Lock All” available channels. The channel numbers that are underlined indicate that there are more than one minor channel number. You can also individually cycle between the following selection by pressing the ACTION button:

- Channel Available — Green color
- Channel locked — Red color
- Channel Not Available — Black Color

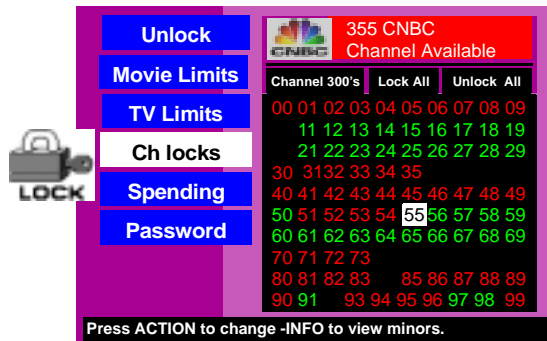

Lock : Ch Lock Screen

Procedure

- In the LOCK menu, press ▲ or ▼ button to highlight CH Locks.
- Press ► button.
- Press ▲ or ▼ to Set Group, press **ACTION** to display channels and press **INFO** to enter Grid.
- Press ▲▼ or ◀▶ buttons to navigate and **ACTION** to change.

Once the user has created a channel lock list, the Digital Satellite Receiver will channel surf (when pressing ▲ or ▼ key) to the locked channels, however the user is then required to enter in the 4-digit password to view the video.

The channel lock list will have its channel number color coded as defined in the following table.

Color	Description
Red	Channel locked
Green	Channel available
Black	Channel not available

ROLLER GUIDE MENU OPERATIONS

Lock : Spending

The feature allows the user to control the amount per event. If the amount is below the event cost, you won't be able to view the event.

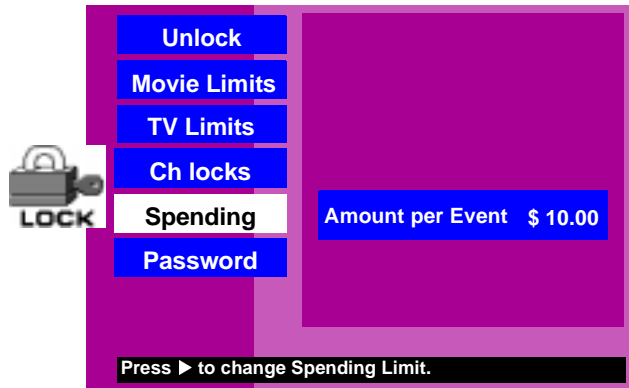

Lock : Spending Screen

Procedure

- In LOCK menu, press ▲ or ▼ button to highlight Spending.
- Press ► button to highlight Amount per event.
- Press ► button to highlight amount field. Use number keys on the remote control to change the numbers.
- Press ACTION to save the new spending limit.

ACCOUNT

The Account category conveys information to the user. This information was either the result of the action by the user or sent from DIRECTV to the Digital Satellite Receiver. This category contains 2 areas:

Purchase	Purchases of programs (Future / Past)
Messages	Electronic messages sent to the user through the satellite link.

Account : Future and Past Purchase

The Purchase screen allows you to review upcoming and past PPV event purchases. Purchases event screen contains information regarding the Event title, Channel Number, Date, Start time and Cost.

Account : Future

The Future Purchase screen displays PPV events purchased, but not yet aired. The Future purchases appear in chronological order, beginning with the soonest event and ending with the most distant future event. This screen also allows you to cancel a PPV purchase. A "CANCEL EVENT" message will appear in the list box. To cancel an event, highlight the event in the list box and press **ACTION** button.

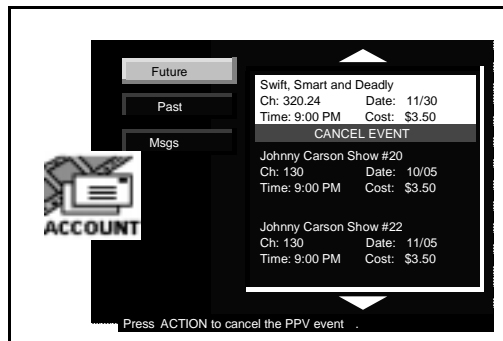

Account : Future Purchase Screen (User Cancelling a PPV event)

ROLLER GUIDE MENU OPERATIONS

Account : Past

This screen allows you to review PPV purchased events. The PPV events that the subscriber purchased but cancels or does not watch will not be displayed. Following is an example of Past purchase screen.

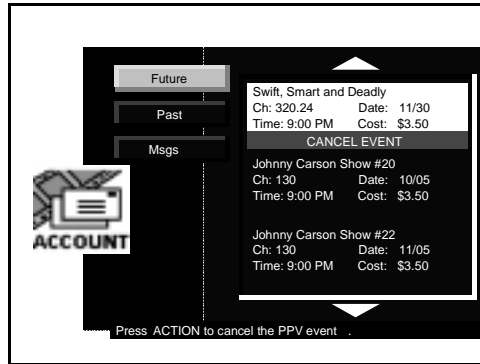

Account : Past Purchase Screen

Account : Msgs (Unread and Read)

The message screen displays messages sent to the Digital Satellite Receiver from DIRECTV. Unread messages are listed before the Read Message.

You can delete the Read messages. To delete the Read Message, highlight the Read Message and press the **ACTION** button.

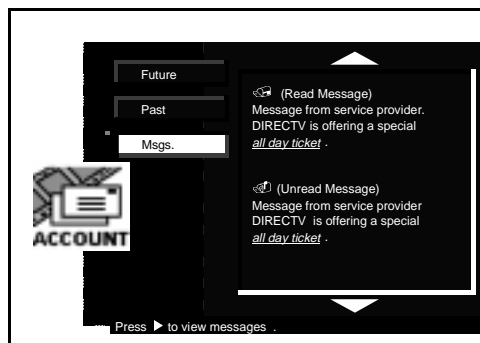

Account : Message Screen

Options

The Options menu gives you the ability to configure the Digital Satellite Receiver. These options can affect the overall behavior of the Digital Satellite Receiver. Options menu has the following sub-options:

- Audio
- Clock
- Favorites
- About
- Upgrades
- Features

Options : Audio

The Audio option allows you to select the Language preferences. Following are the Language preferences:

- English (default language)
- Spanish
- French
- German
- Italian
- Japanese
- Korean
- Chinese

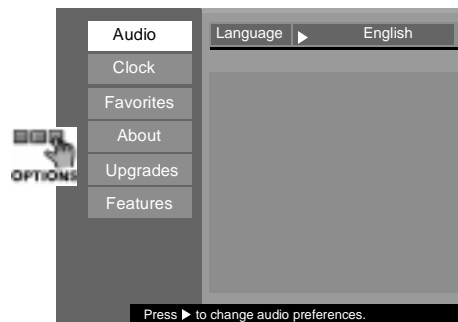

Options : Audio Screen

Procedure

- Press MENU button to display Rollerguide.
- Press ▲▼ buttons to highlight OPTION Icon. Press ACTION button to display the OPTION menu. Audio is highlighted.
- Press ► button to change audio preferences.
- Press ► button to change Audio Language preferences.
- Press ▲ or ▼ buttons to select the preferred language.

Note: *The Audio Language preference is used in cases where a program has multiple audio tracks. As an example, if a program is encoded with two audio tracks (English/Spanish) and you have selected Spanish as the Audio Language preference, then the Spanish audio track is automatically selected for that particular program.*

- Press **ACTION** button to save the language setting.
- Press ◀ button once to return to Options menu.

ROLLER GUIDE MENU OPERATIONS

Options : Clock

The clock option allows you to configure the system clock. When connected to DIRECTV® service, you can set the DST (daylight savings time), Time Zone and reset the time to what is current in the smart card.



DIRECTV Screen

Procedure

- Select **OPTIONS** from the Rollerguide.
- Press **ACTION** button to display the **OPTIONS** menu.
- Press **▲▼** buttons to highlight **Clock**. **Clock** sub-menu is displayed.
- Press **►** button to change the clock settings.
- Press **►** button to highlight **DST**.
- Press **▲▼** buttons to select **Observed** or **Not Observed**.
- Press **ACTION** button.
- Press **▼** button to highlight **Time Zone**. Press **►** button to change and **▲▼** buttons to navigate the **Time Zone** settings.
- Press **ACTION** button .
- Press **▼** button to highlight **Reset Time**.
- Press **ACTION** button to reset time.
- Press **◀** button three times to exit Rollerguide.

Options : Favorites

The Favorites Option allows you to create a favorite channel list when you toggle the FAV mode in the Advanced Program Guide™ or to remove all channels from the favorite list (Delete All), as shown below.

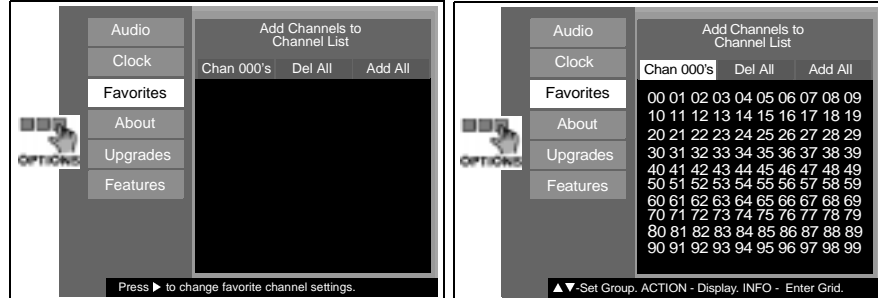

Options : Favorites Screens

Procedure

- In Options Menu, press ▲ or ▼ button to highlight Favorites.
- Press ► to change Favorite channel settings.
- Press ▲▼ buttons to set Group.
- Press **ACTION** button to display all channels in that group. Highlighted numbers are the channels available in that group.
- Press **INFO** to enter grid.
- Use ▲▼ or ◀▶ buttons to navigate.
- Press **ACTION** button to change.
- Press ► button to highlight Delete All or Add All.
- Press **ACTION** to enter your choice.
- Press ◀ button repeatedly to exit Favorite sub-menu.

ROLLER GUIDE MENU OPERATIONS

Options : About

The About screen displays assorted information about the manufacturer, including the following:

- Product Description
- Version
- Serial # number of the Digital Satellite Receiver
- Model #

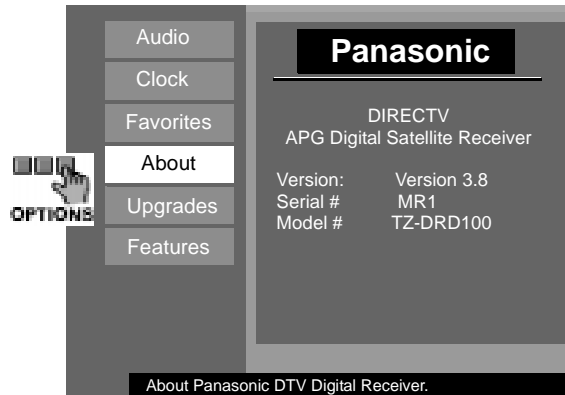

Options: About Screen

Procedure

- Press **MENU** button to display the Rollerguide.
- Press **▲▼** buttons to highlight the OPTIONS Icon.
- Press **ACTION** button to display the OPTIONS screen.
- Press **▲▼** buttons to highlight About. Information about the unit is displayed.
- Press **◀** button twice to exit the Rollerguide menu.

Note: Your digital satellite receiver is able to receive upgrades or modifications to some of its features and functions. These modifications will occur automatically, usually at times when the receiver would likely be turned off. If your receiver is on when an upgrade or modification is sent, you may experience a disruption in reception for a minute or two. Your reception should return to normal after the modification is complete. Do not unplug your receiver while an upgrade is in progress. Please consult the Upgrade Menu to find a schedule of upgrades or modifications planned by DIRECTV.

Options : Upgrades

This screen shows the past and present version of the software and any future upgrades.

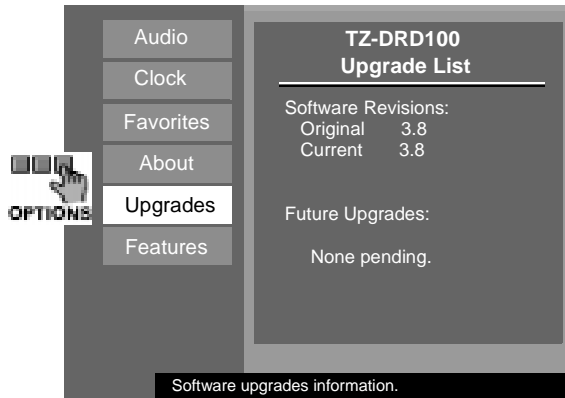

Options: Upgrades Screen

Procedure

- In the Options menu, press ▲ or ▼ button to highlight Upgrades. The software information is displayed.

Options: Features

This screen shows the special features of the Digital Satellite Screen.

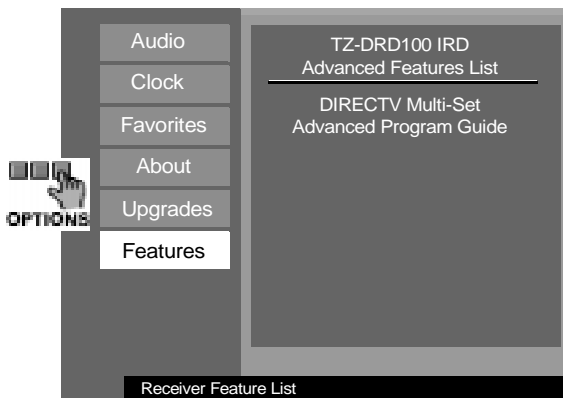

Options: Features Screen

Procedure

- In Options menu, press ▲ or ▼ button to highlight Features. Information regarding the Digital Satellite Receiver is shown.

ROLLER GUIDE MENU OPERATIONS

TIMER

This Digital Satellite Receiver contains eight timers that are capable of tuning the Digital Satellite Receiver on and off at selected times, on selected channels and on selected days. The timer options provide you an automatic way of controlling the Digital Satellite Receiver when it is active. The options are the following:

- OFF (default state)
- ON

Off state

The **Off** state disables the timer and clears the timer data fields.

On state

The **On** state enables the timer to perform several actions once a timer is active. The Digital Satellite Receiver is turned ON and it is tuned to the specified channel. Once the event has ended the Digital Satellite Receiver is turned OFF.

By leaving a timer in a ON mode, the Digital Satellite Receiver will tune to that channel every week at that specified time and day. To turn off the timer, toggle the ON mode to OFF.

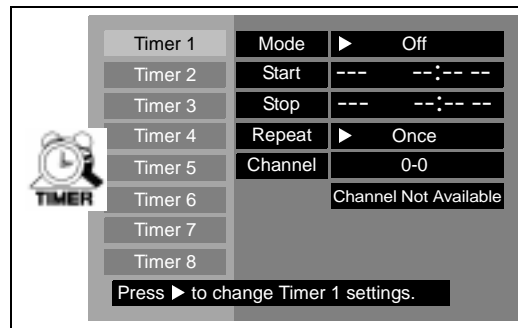

Procedure

- Press **MENU** button to display the Rollerguide menu.
- Press **▲▼** buttons to highlight **TIMER** icon.
- Press **ACTION** button to display the **TIMER** menu.
- Press **▲▼** buttons to select the desired Timer.
- Press **▶** button to change **TIMER** settings.
- Press **▶** button to enter the mode field.
- Use **▲▼** buttons to select the Mode OFF or ON.
- Press **ACTION** button to save your selection.
- Press **▼** button to select Start (current day and time are shown).
- Use **▶** and **▲▼** to select day, press **▶** and **▲▼** to select hour and press **▶** and **▲▼** to select minutes.
- Press **◀** to highlight Start and press **▼** to select Stop and repeat procedure to set day, hours and minutes.
- Press **▼** button to highlight Channel. Use numeric keys on the remote control to enter channel number. Press **ACTION** to enter your channel selection.
- Press **▼** button to highlight Repeat.
- Press **▶** button to highlight weekly or once.
- Use **▲▼** buttons to select the choices.
- Press **◀** button 3 times to exit the menu.

TIMER (Cont.)

Note: All Data fields must be entered prior to setting the view mode. Timers cannot overlap between the timers. The first entered timer will override the other timers.

 <p>TIMER Activation</p>
<p>The TIMER is active when the Digital Satellite Receiver is OFF or ON. The Digital Satellite Receiver will switch to the selected channel at the selected time set in the TIMER.</p>

Timer Error Messages

The Digital Satellite Receiver will scan the timer data fields and notify you of any problems before letting you set the viewing mode.

Timer Error Messages

Error Condition	Error Message
The system time was not set	NOTICE: Clock must be set
One or more start time elements was not entered	NOTICE: Start time must be entered.
One or more stop time elements was not entered	NOTICE: Stop time must be entered.
The channel number was not entered	NOTICE: Ch number must be entered.
The day conflicts with the other timer	NOTICE: Day conflicts with Timer 2 (or 1)
The start time conflicts with the other timer	NOTICE: Start conflicts with Timer 2 (or 1)
The stop time conflicts with the other timer	NOTICE: Stop conflicts with Timer 2 (or 1)
The stop time conflicts with start time	NOTICE: Stop conflicts with start time

Glossary and Acronyms

APG	Advanced Program Guide™ the DIRECTV electronic program guide.
ATSC	Advanced Television Systems Committee. Standardization body that developed the Digital Television Terrestrial formats.
CAM	Conditional access module, usually referred to as the access card . A removable, electronic subassembly providing conditional access control of the subscriber terminal.
CSR	Customer Service Representative
DIRECTV	DIRECTV is a registered trademark of DIRECTV, Inc., a unit of Hughes Electronics Corporation.
DST	Daylight Saving Time
DTV	Digital Television
IPPV	Impulse pay per view. A method for ordering service on “impulse” where payments are required for each program or special event independently.
LNB	Low Noise Block downconverter. Portion of ODU that receives the satellite signal and converts the signal into L-band frequency of 950-1450 MHz.
MPAA	Motion Picture Association of America. Guild governing rating assignments to movies.
NTSC	National Television Systems Committee. Standardization body that developed the Analog Television Terrestrial formats.
ODU	Outdoor Satellite Dish Unit. The System that provides signal reception and down conversion.
OPPV	Order Ahead pay per view. Movie purchases placed by calling a customer service representative rather than using the on-screen displays. Necessary to purchase movies when the subscriber does not connect the phone to the Digital Satellite Receiver.

OSD	On-screen display
Password	A stored word a user must provide in order to perform a function.
SD	Standard Definition
Smart Card	Credit card sized microcomputer capable of securely storing service authorization and system preferences such as pay per view lock. Also known as the CAM.
Subscriber	Customer of the DIRECTV Service

This product incorporates copyright protection technology that is protected by U.S. patents and other intellectual property rights. Use of this copyright protection technology must be authorized by Macrovision, and is intended for home and other limited pay-per-view uses only unless otherwise authorized by Macrovision. Reverse engineering or disassembly is prohibited.

U.S. Patent Nos. 6,020,880; 5,987,635; 5,926,573; 5,917,481; 5,874,995; 5,819,035; 5,802,241; 5,737,019; 5,699,125; 5,650,825; 5,623,311; 5,619,337; 5,583,574; 5,534,944; 5,532,748; 5,510,842; 5,502,493; 5,485,215; 5,477,397; 5,387,939; 5,367,334; 5,325,125; 5,311,297; 5,294,974; 5,293,229; 5,260,788; 5,168,358; 5,130,796; 5,126,841; 5,113,255; 4,984,081; RE36,507; RE36,015; other U.S. and foreign patents pending.

TROUBLESHOOTING

Troubleshooting

Before requesting service for this unit, check the table below for a possible cause of the problem you are experiencing. Some simple checks or a minor adjustment on your part may eliminate the problem and restore proper operation.

If you are in doubt about some of the check points, or if the remedies indicated in the table do not solve the problem, consult your dealer or call **1-888-726-2377** for assistance.

Symptom	Remedy
No power	Check that the AC power cord is securely plugged into the AC IN jack. Check that the AC power plug is securely plugged into the power outlet.
No reception	<ul style="list-style-type: none"> •Check that equipment is connected properly. •Make sure that the Satellite Dish unit is properly mounted and installed. •Check that antenna is properly installed and oriented. •Check that the antenna or cable wire is connected properly.
No picture	<ul style="list-style-type: none"> •Check that equipment is connected properly. •Check if the channel is available.
No sound	Check that equipment is connected properly.
The remote control is not responding	<ul style="list-style-type: none"> •Check that the batteries are installed with the correct polarities (+ and -). •The batteries are depleted: Replace them with new ones. •Point the remote control unit at the remote control sensor and operate. •Operate the remote control unit at a distance of not more than 23 feet (7 meters) from the remote control sensor. •Remove any obstacles between the remote control unit and remote control sensor.
The remote control is operational, but the Digital Satellite Receiver is not responding	<ul style="list-style-type: none"> •Check that the AC power plug is securely plugged into the power outlet. •Make sure the Digital Satellite Receiver is on. •Make sure the remote control is in SAT mode.
The remote control is operational, but other component(s) are not responding	<ul style="list-style-type: none"> •Check that the AC power plug is securely plugged into the power outlet. •Make sure the component(s) are on. •Reprogram the remote control to make sure it is programmed properly to operate the component(s). •Make sure the remote control is in the proper component mode (i.e. TV, VCR, DVD, etc.).
The ACTION button is not responding	•Make sure the remote control is in SAT or TV mode.
No key operation (by the unit and/or the remote control) is effective.	Set the POWER button to OFF and then back to ON. Alternatively, turn off the power, disconnect the power plug and then reconnect it. (The Digital Satellite Receiver may not be operating properly due to lightning, static electricity or some other external factor).
No key operation is effective. OSD reads: "Searching for Satellite Signal."	ODU (Satellite Dish) is momentarily disconnected from the Digital Satellite Receiver. Alternatively, turn off the power, disconnect the power plug and then reconnect it. (The Digital Satellite Receiver or the satellite dish antenna may not be operating properly due to lightning, static electricity or some other external factor).
VCR is not responding	<ul style="list-style-type: none"> •Check that the AC power plug is securely plugged into the power outlet. •Check that equipment is connected properly. •Make sure remote control is in VCR mode.
Timer does not work	<ul style="list-style-type: none"> •Make sure the clock is set. •Check to see whether the timers have overlapping times programmed. •Check if the timer did not reset to default settings.

Service Information

Product Service

Do not attempt to remove the cover or repair the unit yourself. Refer servicing to qualified personnel only.

Product Information

For product service, product information or assistance with product operation, consult your dealer or call **1-888-726-2377 (Monday-Friday/ 8AM-10PM) (Sat & Sun/ 10AM-10PM) EST.** Please have your Digital Satellite Receiver Identification Number (ID#) available when you call. The ID# is displayed on your TV screen when the Digital Satellite Receiver is tuned to any unavailable channel.

If you ship the product

Carefully pack and send it prepaid, adequately insured and preferably in the original carton. Attach a postage-affixed letter, detailing the complaint, to the outside of the carton. **DO NOT** send the product to the Executive or Regional Sales offices. They are **NOT** equipped to make repairs.

For service assistance with hardware, please call:

1-888-726-2377

For assistance with software related problems or access card, please call DIRECTV:

1-800-DIRECTV

NOTES

**Panasonic Consumer Electronics Company,
Division of Matsushita
Electric Corporation of America**
One Panasonic Way
Secaucus, New Jersey 07094