

X8 PRO

Electric Scooter

USER MANUAL

Thank you for your purchase of the X8 PRO Electric Scooter!

To ensure your safety and the safety of others, please read and follow the guidelines in this user manual carefully and thoroughly before and during riding.

We will update the product in the future according to customers' feedback.

The product you received may have small difference from picture.

TABLE OF CONTENTS

1.GENERAL INFORMATION

- 1.1 Important Information
- 1.2 Safety Warnings
- 1.3 Disposal at End-of-Life
- 1.4 Main Specifications

2.PARTS & FEATURES

- 2.1 What's in the Box?
- 2.2 X8 PRO Diagram
- 2.3 Buttons Information
- 2.4 Display Information

3.FOLDING & ASSEMBLY

- 3.1 Assembling the Handlebars
- 3.2 Standing the Scooter
- 3.3 Folding & Unfolding the Scooter

4.CHARGING

- 4.1 How to Charge
- 4.2 Battery Specifications

5.USAGE

- 5.1 How to Ride
- 5.2 Practicing Guidelines

6.MAINTENANCE

- 6.1 Cleaning
- 6.2 Storage
- 6.3 Transportation

7.WARRANTY

Section 1

GENERAL INFORMATION

Before operating this vehicle, please read all instructions. This manual will guide you through the functions, usage, and proper care of your X8 PRO. Before contacting customer service, please have your purchase information ready as this may be needed during the call. This information may be recorded below.

Date of Purchase: _____



Place of Purchase: _____

 **It is important that you follow all safety warnings that appear throughout this manual and exercise good judgment when using your X8 PRO scooter. Consult this manual before attempting to ride.**

1.1 Important Information



Within this manual, “the X8 PRO”, “your X8 PRO”, “your scooter” and “the scooter” refer to the X8 PRO Electric Scooter. The X8 PRO is a personal scooter that uses electrical power. By riding the X8 PRO scooter, the user acknowledges and accepts responsibility for all risks associated with the use of the scooter which may include, but are not limited to, muscle injuries, broken bones, lacerations, serious injury, and possible death, which may be sustained while using the X8 PRO.

To better ensure your safety, **ALWAYS USE APPROPRIATE PROTECTIVE GEAR**, read and follow all instructions and warnings in the User Manual.

-  Appropriate protective gear should include helmet and other gear including knee and elbow.
-  Use the X8 PRO at your own risk.

1.2 Safety Warnings

When reading this manual, note these icons:

 Notes with this icon **MUST** be read, understood, and obeyed to prevent injury or damage, etc.  Notes with this icon include relevant information.

 Properly dispose of all packaging material. Some items may be packed in plastic bags or material and may cause suffocation or injury to pets or children.

 Verify that all parts of the product are accounted for. If any part is missing, call customer service.

 If any parts or cables or surrounding parts are damaged, do not use the product.

 Never insert objects into the product other than the cables etc. as described in this manual.

 If the product is to be used by children, the care giver should explain the contents of the user manual to the children. The care giver should provide adequate supervision to ensure that the device is being used as explained in the user manual.

 Use only the parts included in the original packaging or received from the manufacturer.

 Risk of shock. Do not allow water and/or liquids to come in contact with any part of the product.

 Use dry, non-abrasive cloth to remove debris or dust. Do not spray liquids onto the product.

 Never submerge the product or any of the product's components and/or accessories into water.

 Do not ride over stairs.

 Do not allow more than one person on the scooter at a time.

 The product shall only be used as described in this manual.

 Cover the product to protect it from dust. Do not store in a dusty environment as, with all electronic devices, this may cause damage over time.

 **WARNING- RISK OF FIRE** - No user serviceable parts

1.3 Disposal at End-of-Life

This product must not be disposed of by incineration, land filling, or mixing with household trash. Improper disposal of the battery contained within this product may result in the battery heating up, rupturing, or igniting which may cause serious injury. The substances contained inside the battery present chemical risks to the environment. X8 PRO Electric Scooter at its end-of-life is to dispose of the entire unit at or through an e-waste recycling center, program, or facility. Local regulations and laws pertaining to the recycling and disposal of lithium-ion batteries and/or products containing them will vary according to country, state, and local governments. You must check laws and regulations corresponding to where you live in order to dispose of the battery and/or unit properly. It is the user's responsibility to dispose of their waste equipment properly in accordance with local regulations and laws.

For additional information about where you should drop off your batteries and electrical or electronic waste, please contact your local or regional waste management office, your household waste disposal service, or your point-of-sale.

1.4 Main Specifications

Indicators	Items	Parameters
Dimensions	Folded Size	1080 x 420 x 410 mm
	Opened Size	1050 x 420 x 1080 mm
Weight	Vehicle Weight	12.5 kg
Riding Requirements	Max. Load	100 kg
	Max. Incline	17°
	Suitable Terrain	Hard Surfaces, Flat roads, Inclines under 17°
	Working Temp.	25°C
	Storage Temp.	-10°C to 50°C
Performance	Speed	Up to 25 km/h
	Range	Up to ~25km
Tires	Front Tires	Hard Rubber; Motorized
	Rear Tire	Hard Rubber; Passive
Battery	Type	Rechargeable Lithium-Ion
	Management	Balance, Over-charge, Under-voltage, Overheating automatic shutoff
	Voltage	36V 6Ah
	Watt Hours	216Wh
Charger	Model	42150
	Input Voltage	AC100-240V 50/60Hz 2A
	Output Voltage	DC 42V 1.5A
	Charging Time	~5 hours

Section 2

PARTS & FEATURES

2.1 What's in the Box?

- 1 x X8 PRO Scooter
- 2 x Handle Bar
- 1 x Charger
- 1 x User Manual

2.2 X8 PRO Diagram

- | | |
|--------------------|---------------------|
| 1. Handle bar | 11. Rubber cover |
| 2. Headlight | 12. Rear fender |
| 3. Adjustable pipe | 13. Kick stand |
| 4. Quick release | 14. Display |
| 5. Stem pipe | 15. Brake |
| 6. Suspension | 16. Function button |
| 7. Front fender | 17. Accelerator |
| 8. Front fork | 18. Motor |
| 9. Front wheel | 19. Battery cover |
| 10. Charging port | 20. Folding part |
| | 21. Rear light |

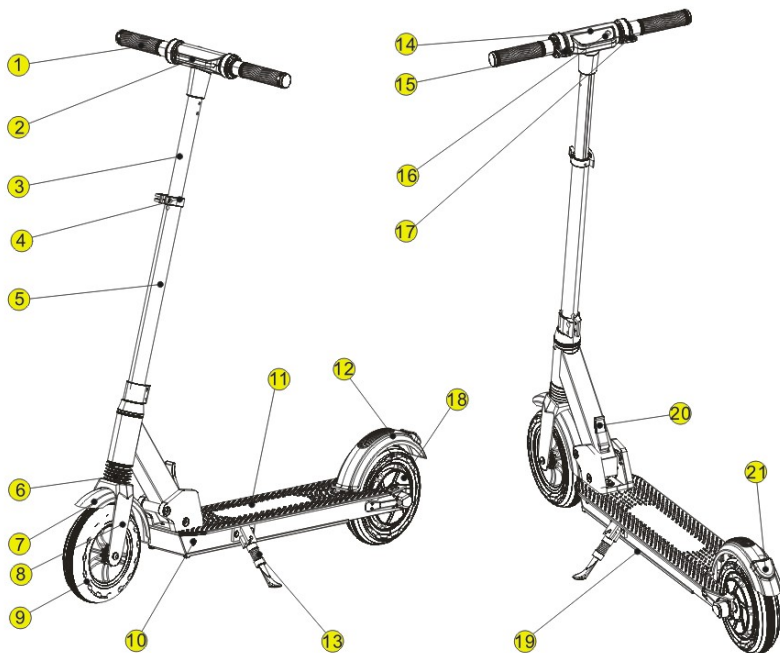

2.3 Buttons Information

The X8 PRO's display features several different elements. Be sure you understand these before attempting to ride.

Power: Press and hold approx. 3~5 seconds to turn the scooter on/ off.

Cruise Control : Maintain same speed for at least 6 sec to use this feature. Cancel it by pressing brake or accelerator.

MODE: Press once quickly to switch between speed modes 1, 2, and 3.

Headlight: Press twice quickly to turn the headlight on/off.

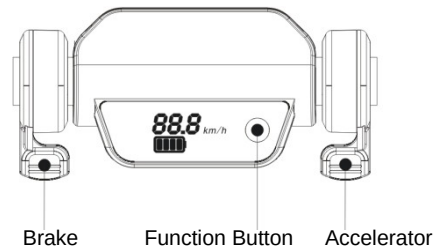

2.4 Display Information

 : This icon indicates how much battery life you have left.

km/h - These numbers indicate the current speed.



 **When the battery level is low, stop riding, turn off the scooter, and fully recharge it before riding again.**

Section 3

FOLDING & ASSEMBLY

Make sure the X8 PRO is turned off before working with any of its parts. The scooter comes mostly assembled within the package. Some minor assembly is required before riding. All parts and tools are included.



3.1 Assembling the Handlebars

Before installing the handlebars, using these 4 M5 screws to tighten the handle bar part. Make sure the 4 screws securely tightened.

3.2 Standing the Scooter

1. Locate the kickstand on the side of the scooter's deck.
2. Push the kickstand down and away from the scooter then carefully lean the weight of the scooter onto the kickstand.

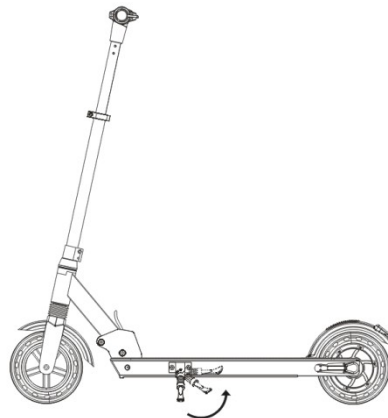

3.3 Folding & Unfolding the Scooter

1. Firstly, kick the stand. Pull the folding latch down. Next, pull the stem down towards the deck.
2. When folding and unfolding, please make sure it is folded and pulled to unfolded status after you can hear a small sound.
3. To unfold the scooter, pull up the stem away from the deck. When the stem is fully unfolded, you can hear a small sound to make sure it is securely unfolded.

⚠ Before moving, lifting, or otherwise transporting the scooter, ensure it is turned off.

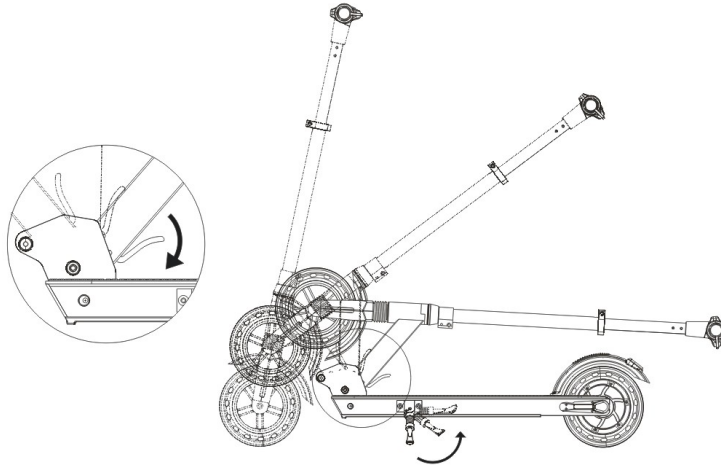

Section 4

CHARGING

⚠ Charge the scooter before using it.

4.1 How to Charge

Step 1. Ensure the scooter is turned off before charging and remains off while charging.

Step 2. Locate the charging port near the kickstand under the deck and remove the cap if needed.

Step 3. Use the charger and the charging port to connect the scooter to an outlet.

Step 4. While the scooter is charging, the adapter's indicator light will turn red.

⚠ If charging for the first time, charge the scooter for at least 4 hours before using it.

Step 5. When the scooter is fully recharged, the adapter's indicator light will turn green. You may then disconnect the scooter from the charger.

⚠ DO NOT, under any circumstances, use the scooter while it is connected to the charger.

⚠ Do not charge longer than necessary. Standard charging time is approx. 3 hours(4ah battery). 4.5hours(6ah battery), 5.5hours(7.5ah battery). Charging longer than this may affect battery life and/or performance.

⚠ To maximize the battery life, charge it once every other month or every couple days after riding.

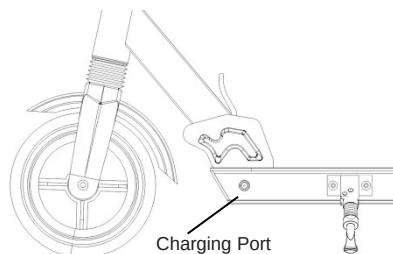





4.2 Battery Specifications

Items	Parameters
Type	Rechargeable Lithium-Ion
Charging Time	~5 hours
Voltage	36V
Capacity	6Ah
Weight	1.6kg
Dimensions	340*75*42 mm
Operating Temp.	-10°C to 40°C
Charging Temp.	5°C to 45°C
Storage Temp.	-20°C to 50°C
Watt Hours	216Wh
Management	Balance, Over-charge, Under-voltage, Overheating automatic shutoff

Section 5

USAGE

Read the following information before attempting to ride your X8 PRO.

-  A helmet as well as other protective gear must be worn at all times.
-  The X8 PRO supports up to 100 kg. Do not carry passengers.
-  Only operate the X8 PRO where permitted. Local laws may restrict where you may ride.
-  The X8 PRO contains a motor and may be classified as a motor vehicle under local laws in your area. It is your responsibility to abide by any local laws restricting how or where you may ride.

5.1 How to Ride

Assuming you have equipped suitable protective gear and that the X8 PRO has been placed on a level surface, is charged, and does not have any issues, follow the steps below. For your safety, please read this entire section before attempting to ride.

 For your safety, please carefully read this entire section before attempting to ride.

Step 1. Carefully step on with one foot and stand upright but relaxed. Grab both handles.

Step 2. Keep one foot on the ground and kick off to begin accelerating manually. Use the handles to steer.

Step 3. Start your riding by pressing the power button, and riding forward by pushing the throttle.

Step 4. To stop, release the throttle and use the handbrake, footbrake, or both to gradually coast to a stop then step off the scooter one foot at a time. Be extra cautious when dismounting for the first time.

Step 5. To turn the scooter off, remain at a complete stop for a few seconds and press and hold the power button for 3~5 seconds.

 The display shows how much charge is left in the battery. Make sure the battery is at full power before heading out on a long distance ride.

5.2 Practicing Guidelines

Practice until you are comfortable with using all of the scooter's functions. See the following tips below.

- Avoid wearing anything that can drape over or get caught into/under the wheels. Wear closed-toe, flat shoes to maintain flexibility and stability.
- Practice until you can easily get on, move forward, turn, stop, and dismount with ease.
- The scooter is designed to handle inclines up to 15°. Riding over inclines is not recommended.
- The X8 PRO is designed for relatively smooth, flat terrain.

- Until you are comfortable using the scooter, avoid operating in places with slopes, pedestrians, or obstacles.

 The X8 PRO weighs approximately 12.5 kg. If you are unsure of your ability to lift it with one hand, please lift it with both hands or have a second person help. Remember to fold scooter before picking it up.

Section 6

MAINTENANCE

 **Do not perform any maintenance when the power is on, or the battery is charging.**





After each ride, especially if you have traveled a long distance, inspect your scooter.

- Inspect the brakes to make sure that is working properly.
- Make sure all screws and bolts are taut and properly fastened to prevent injury and unnecessary wear and tear.

 **Tire wear and tear is normal. The rate at which the tires deteriorate depends on riding style i.e. casual riding may yield minimal wear while performance and/or heavy drifting may yield excessive wear. To purchase tire replacements and/or for questions about your scooter's parts, please visit our website.**





6.1 Cleaning

The X8 PRO may need cleaning after riding for extended periods of time.

-  Completely power off the scooter before cleaning.
-  Use dry, non-abrasive cloth to gently remove debris or dust.
-  The X8 PRO may not come in contact with it in any kind of liquid.
-  Never use alcohol or ammonia-based cleaning solutions.
-  Never spray liquid directly onto any part of the scooter.

6.2 Storage

To store the X8 PRO, see the following information below.

-  Before storing, fully charge the X8 PRO to prevent battery over-discharge due to non-use.
-  If storing for more than one month, discharge and recharge the battery every three months.
-  Cover the X8 PRO to protect it from dust. Do not store in a dusty environment as, with all electronic devices, this may cause damage over time.
-  Do not store in an unheated garage, shed, or other location with extreme temperature fluctuations.

6.3 Transportation

Before moving, lifting, or otherwise transporting the scooter, turn it off. Fold the scooter (see Section 3.3 for instructions) and pull the scooter along as you move, if needed.

-  When lifting the entire scooter, please note that the X8 PRO weighs approximately 12.35 kg. If you are unsure of your ability to lift this weight, please use both hands or have a second person help.

Section 7

WARRANTY

Your X8 PRO Electric Scooter (“Product”) includes a One Year Limited Hardware Warranty (“Warranty”). The Warranty covers product defects in materials and workmanship under normal use. This Warranty is available only to original purchasers. This Warranty gives you specific legal rights and you may also have other rights which vary from state to state.

This Warranty starts on the date of your purchase and lasts for one year (the “Warranty Period”). The Warranty Period is not extended if the Product is repaired or replaced. We may change the availability of this limited warranty at our discretion, but any changes will not be retroactive.

When a product or part is exchanged, any replacement item becomes your property and the replaced item becomes our property. This warranty only covers technical hardware defectiveness during the warranty period and under normal use conditions. We do not warrant uninterrupted or error-free operation of this Product.

This Warranty does not cover any damage due to: (a) transportation; (b) storage; (c) improper use; (d) failure to follow the product instructions or to perform any preventive maintenance; (e) modifications; (f) unauthorized repair; (g) normal wear and tear; or (h) external causes such as accidents, abuse, or other actions or events beyond our reasonable control.

DISCLAIMER OF WARRANTY: OUR LIABILITY SHALL UNDER NO CIRCUMSTANCES EXCEED THE ACTUAL AMOUNT PAID BY YOU FOR THE DEFECTIVE PRODUCT, NOR SHALL WE UNDER ANY CIRCUMSTANCES BE LIABLE FOR ANY CONSEQUENTIAL, INCIDENTAL, SPECIAL OR PUNITIVE DAMAGES OR LOSSES, WHETHER DIRECT OR INDIRECT.

SOME STATES DO NOT ALLOW THE EXCLUSION OR LIMITATION OF INCIDENTAL OR CONSEQUENTIAL DAMAGES, SO THE ABOVE LIMITATION OR EXCLUSION MAY NOT APPLY TO YOU.

THE DURATION AND REMEDIES OF ALL IMPLIED WARRANTIES, INCLUDING WITHOUT LIMITATION THE WARRANTIES OF MERCHANTABILITY AND FITNESS FOR A PARTICULAR PURPOSE ARE LIMITED TO THE DURATION OF THIS EXPRESS LIMITED WARRANTY.

