

tedee TLV1.0 Installation Guide

[Home](#) » [tedee](#) » tedee TLV1.0 Installation Guide

tedee

TLV1.0
Installation Guide

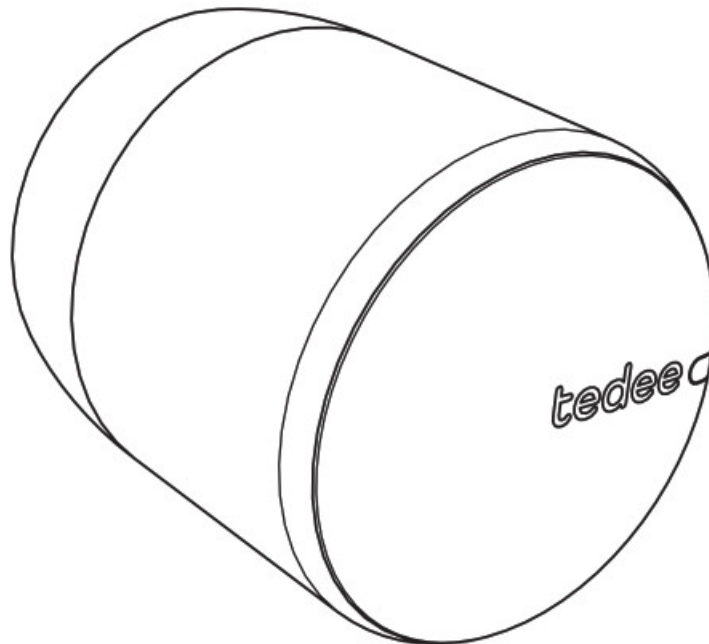

Read installation guide and user manual
and learn how to use your device in a safe and proper manner.

Contents [[hide](#)]

- 1 [quick start with tedee lock](#)
- 2 [the lock setup – go to page 9](#)
- 3 [safety information](#)
- 4 [charging and maintenance guidelines/warnings](#)
- 5 [set of items – what's in the box?](#)
- 6 [activation code](#)
- 7 [setup-3 easy steps](#)
- 8 [charging tedee lock](#)
- 9 [deinstallation of tedee lock](#)
- 10 [factory reset](#)
- 11 [additional and technical information](#)
- 12 [radio frequency](#)
- 13 [Micro USB Cable](#)
- 14 [power supply, battery, and charging](#)
- 15 [software](#)
- 16 [LED signals](#)
- 17 [legal/environmental notes](#)
- 18 [warranty](#)
- 19 [technical support](#)
- 20 [Documents / Resources](#)
 - 20.1 [References](#)
- 21 [Related Posts](#)

quick start with tedee lock

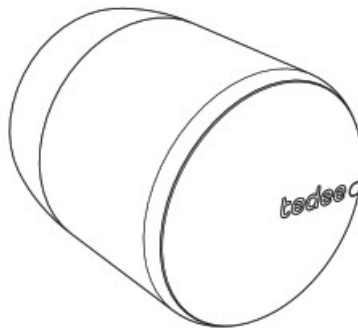

Teddie lock is a smart door lock that can be fitted to GERDA modular cylinder or any other euro-profile cylinder using a special adapter.

Teddie smart lock allows you to unlock the door, share access, and check all activities remotely.

This booklet will give you an overview of the basic features of tedee lock and will help you walk through the setup in three easy steps.

the lock setup – go to page 9

3 easy steps



safety information

WARNING: Read all safety guidelines and warnings. Failure to follow the guidelines and warnings may result in electric shock, fire, and/or serious injury.

safety guidelines/warnings



Do not

- Do not open, modify or disassemble your device.
- Do not self-service any part of the device.
- Do not immerse the device in any liquid or expose it to moisture.
- Do not use the device near an extreme heat source or open fire.
- Do not use the device in an environment of high humidity or dust levels, as well as pollution degree II.
- Do not insert any conductive objects in device openings and gaps.
- The device should not be used by children without adult supervision.
- The device cannot be used as the only mean of access control to rooms or premises that require increased access control.



Do

- If repairs are required, please contact technical support.
- Use only power supply devices provided or recommended by the.
- Read the installation guide and learn how to start working with your device, how to add it to your free app and how to pair it with other tree devices. You can also follow the link: www.tedee.com/installation-guide



Moving parts

- The device contains moving parts. When operating the device remotely, it is not recommended to keep your hands on the housing.

Other information

- This device is safe to use under normal and reasonably foreseeable misuse operating code of conduct. If you notice any signs of errors or hardware malfunction, contact technical support for help. In such case, this device

should be returned to the for necessary repairs under the warranty conditions. Any changes or modifications to the device's hardware or software that are not approved, recommended, or provided by the may void your warranty.

charging and maintenance guidelines/warnings

Battery – please read all precautions before use

- Your product is powered by a rechargeable LiPo battery.
- LiPo Batteries used in this product may present risk of fire or chemical burn if mistreated.
- LiPo Batteries may explode if damaged.
- Hot or cold environment may reduce the capacity and lifetime of the battery.
- A fully charged battery will lose its charge over time when left unused.
- For the best performance, the battery needs to be charged at least every 3 months.
- Do not dispose as household waste or in a fire as they may explode.
- If, for any reason, the battery is damaged and the electrolyte (liquid leakage from the device) is leaking, exposure to the substance must be kept to a minimum and:
 - If swallowed, rinse your mouth and seek medical advice as soon as possible.
 - In case of contact with skin, wash with plenty of water. If skin irritation or rash occurs, consult a doctor.
 - In case of contact with eyes, carefully rinse eyes with water for several minutes. Contact a doctor.
- Do not leave devices with LiPo battery unattended during charging.
- Avoid direct contact with a leaky/damaged battery. This is particularly true if liquid leaking from the device occurs. Avoid contact with liquid, ensure airflow in the room, and report the fault to tedee's customer service department for further safe handling.
- Do not insert any conductive objects in device openings and gap – it may cause short-circuits.
- Dispose of batteries according to your local regulations. Please recycle when possible.
- Information about the battery level is available in the tender app. Do not leave a fully charged battery connected to a charger – overcharging may shorten its lifetime.
- Neither Tree Sp. z o.o. nor our retailers assume any liability for failure to comply with these warnings and safety guidelines. By purchasing this device, the buyer assumes all risks associated with LiPo batteries. If you do not agree with these conditions, return the device immediately before use.
- Batteries in the lock are not interchangeable. Do not remove or replace the battery in your device. Any attempt to do so is risky and may result in product damage and/or injury.
- Additional instructions for professional facilities dealing with battery and accumulator recycling: (1) in order to remove the battery, remove the cover with the logo from the front side of the lock, (2) using a T6 screwdriver remove the two mounting screws, (3) try and remove the PCB, (4) using a soldering iron, warm-up both pads to release the motor ires connected to the PCB, (5) after desoldering, you can disconnect the CB from the motor, (6) you can now manually remove the battery.

Charging and maintenance

- Charge your device only with the provided approved accessories designated for this product.
- Use only sources that comply with the manufacturer's specifications and have the safety approvals required in your country.

- Disconnect the product from the power supply before cleaning. It shall be wiped with a dry cloth only.
- While unplugging the power cord or any accessory, grasp and pull out the plug, not the cord itself. Never use a damaged cable.
- Do not attempt to disassemble the cable as this may expose you to electric shock.
- Tightness grade The tedee lock features an IP20 protection class.

set of items – what's in the box?

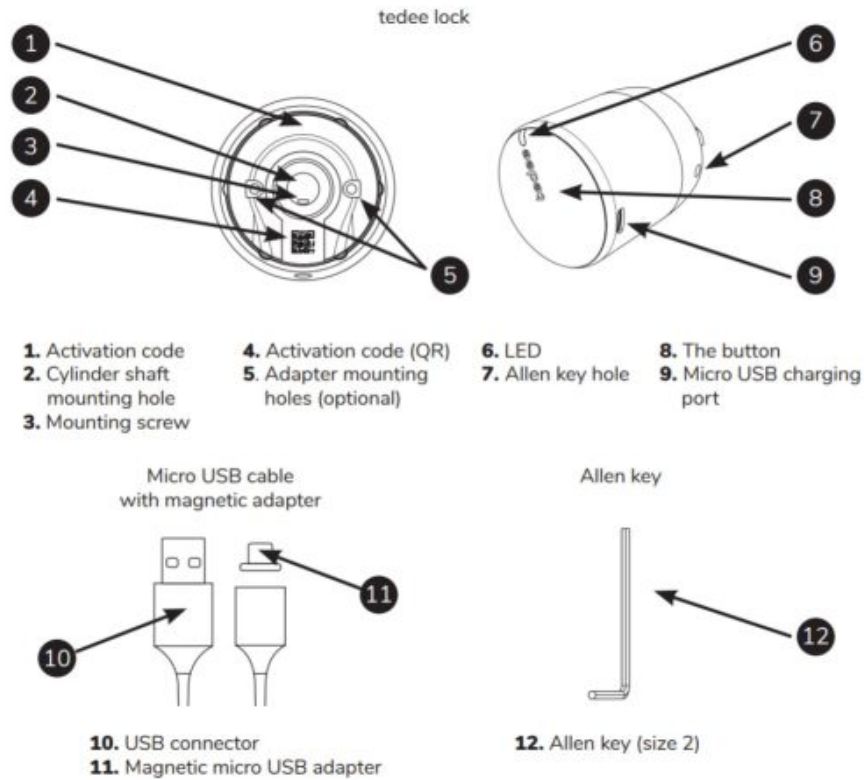

activation code

Activation code (AC) of your tedee lock is printed on:

- last page of this installation guide (1)
- the rear side of your device (2)

While adding your device to the tedee app you can either:

- scan the QR Code
- type in AC manually (14 characters)

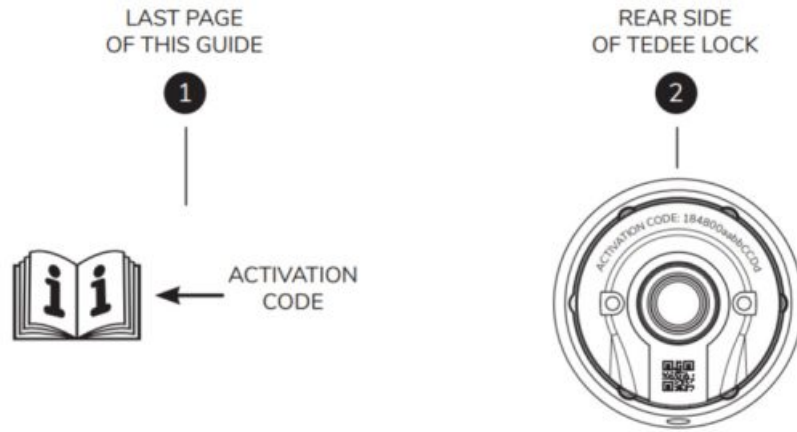

Helpful tip

Before fitting tedee lock to the cylinder, take a photo of your activation code and keep it.

setup-3 easy steps

step 1: install tedee lock

1. Align tedee lock with the shaft of the cylinder and push it forward. **IMPORTANT:** the mounting screw that extends from the lock mounting hole must fit into the groove on the cylinder shaft.

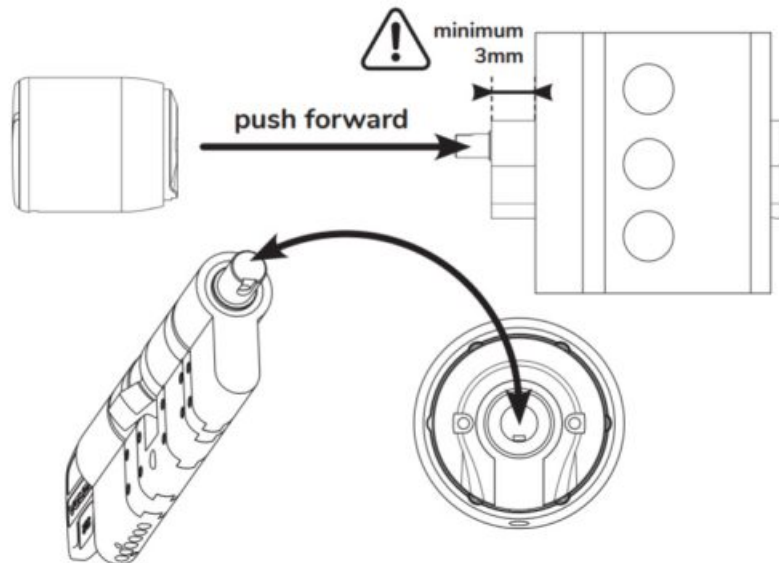

Note: Do not start tedee lock installation before the lock cylinder is installed in the door lock. Make sure that the cylinder sticks out at least 3mm from the lock escutcheon (from the inside of your apartment).

TEDEE LOCK (SIDE VIEW)

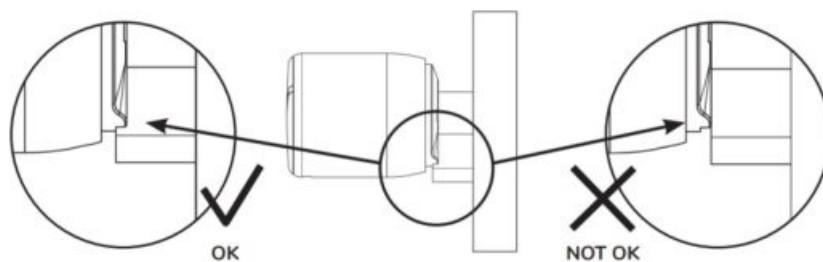

2. Fix tedee lock tightly on the cylinder using the Allen key.

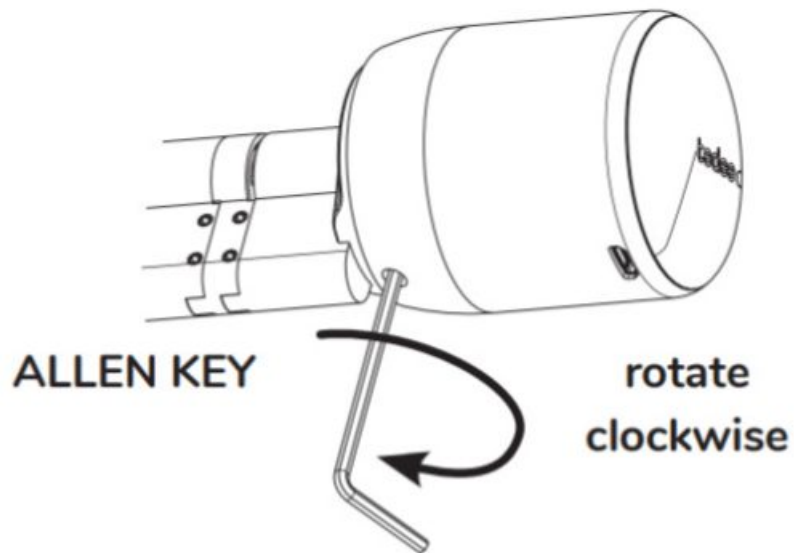

Note: to fix your tedee lock on the cylinder, keep rotating the key until it stops (at least two full turns).

3. Turn on the lock.

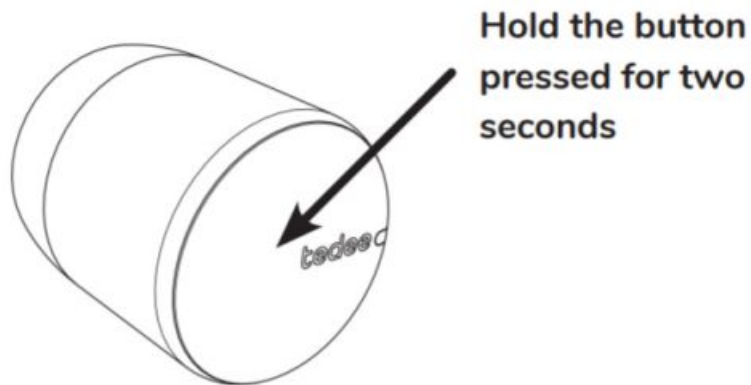

4. Check light signal (LED).

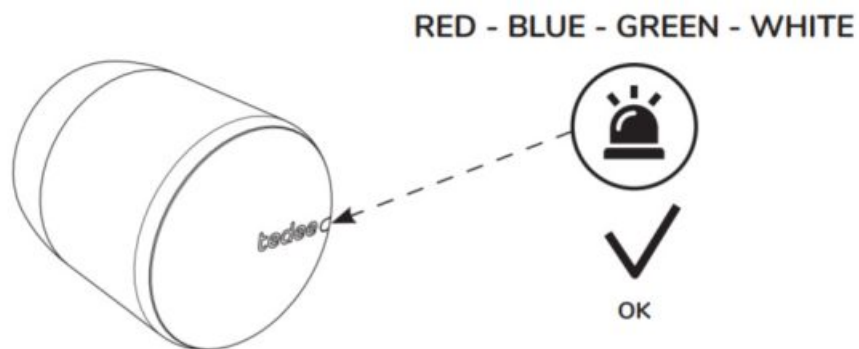

Note: after the RED-BLUE-GREEN-WHITE sequential light signal your tedee lock is ready to be added and calibrated in the app.

step 2: download the tedee app, create new account and log in (skip this step if you already have an account)

1. Download tedee application.

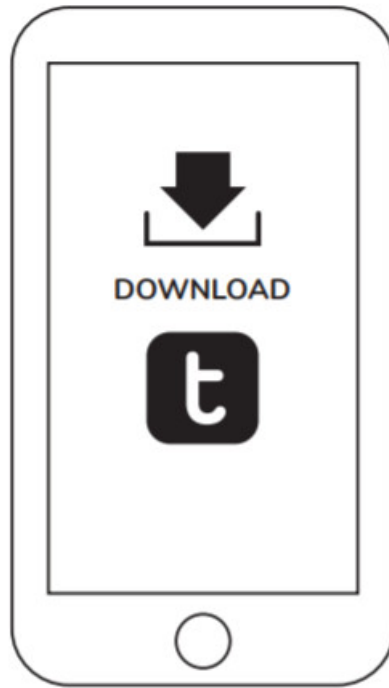

| | Android | iOS |
|------------|---------------------------------------|---------------------------------------|
| Version | 6.0 or higher | 11.2 or higher |
| Connection | Internet and Bluetooth® 4.0 or higher | Internet and Bluetooth® 4.0 or higher |

2. Create an account and log in.

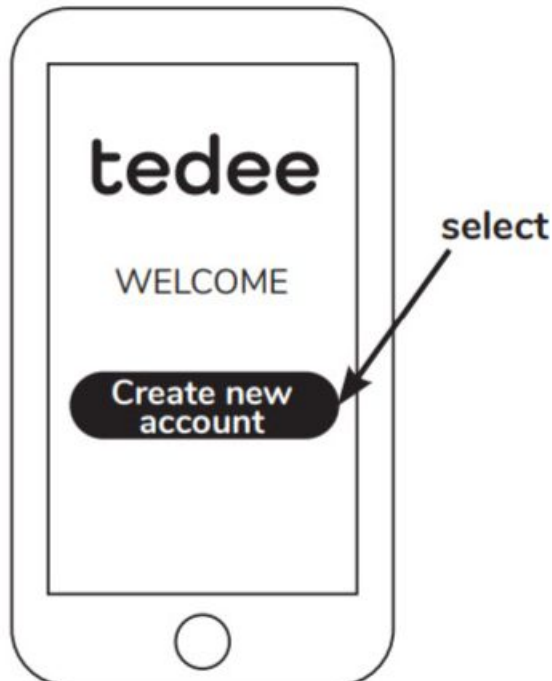

The registration page will open



<https://play.google.com/store/apps/details?id=tedee.mobile>

<https://apps.apple.com/us/app/tedee/id1481874162>

step 3: use the tedee app to activate and calibrate your tedee lock

1. Enable Internet connection, Bluetooth®, and location on your smartphone.



**INTERNET
CONNECTION**



**Bluetooth®
CONNECTION**



LOCATION

2. Log into the tedee application and select the 'Add new device' option from the menu.

tedee

Your Account

Add new device

Help

select



3. Select 'Add device' in the lock section.

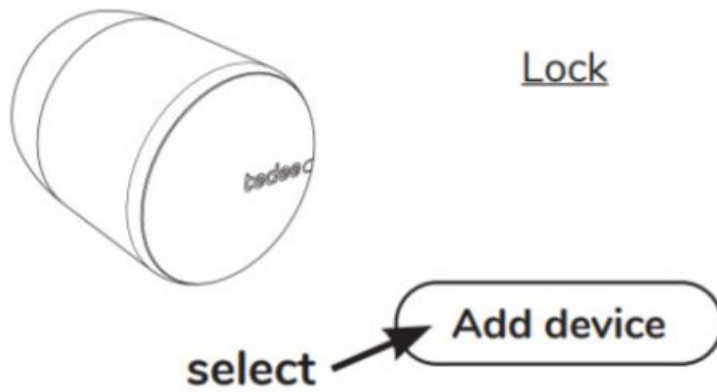

4. Provide activation code (AC) of your tedee lock.

select:

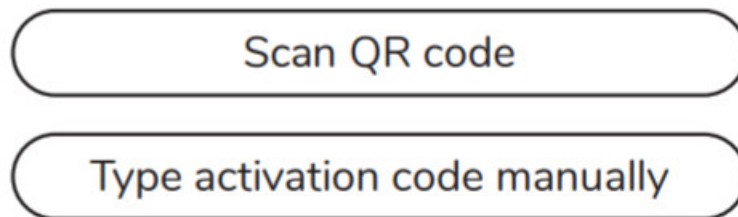

Note: After scanning the QR code or typing in the AC manually follow instructions in the application.

charging tedee lock

1. Plug the micro USB magnetic adapter into the tedee lock charging port and connect the cable.

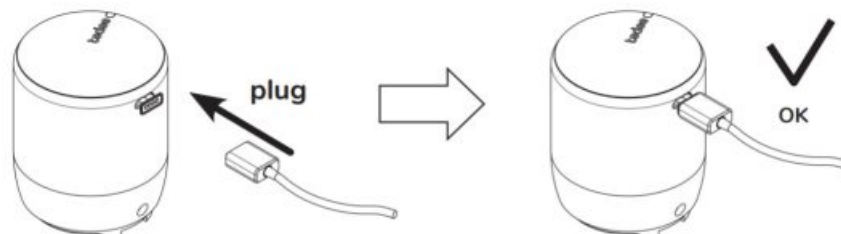

2. Plug the USB cable to a power supply.

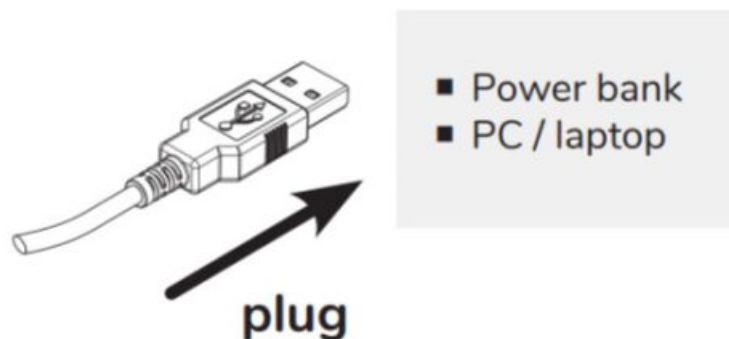

deinstallation of tedee lock

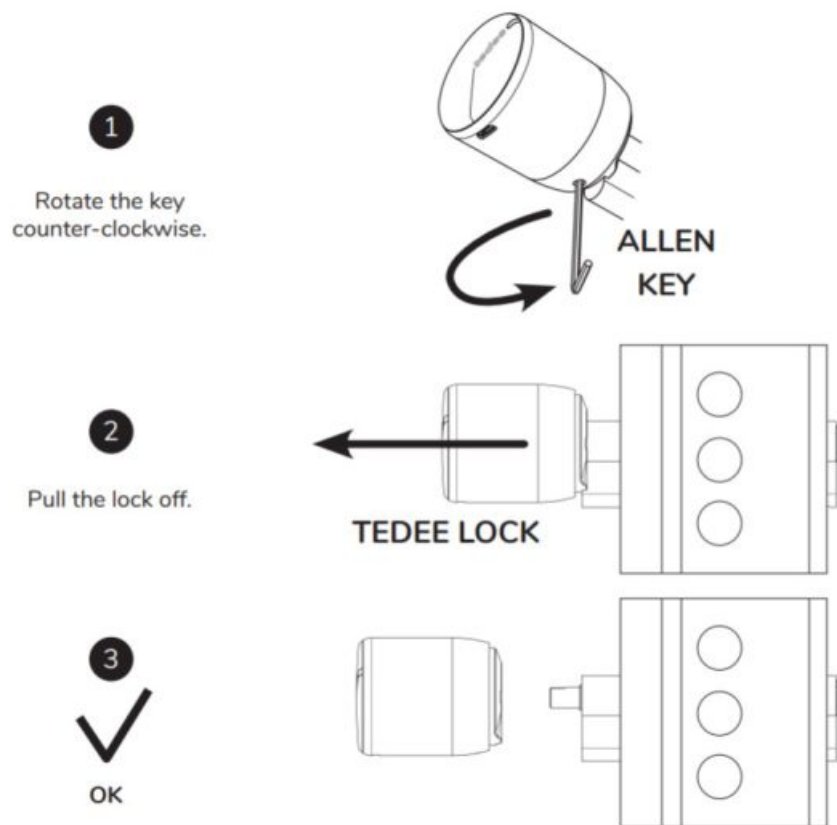

Note: in order to deinstall the tedee lock: first use an Allen key to loosen the screw (three full turns counter-clockwise), and then pull it off to detach from the cylinder.

factory reset

- remove tedee lock from the cylinder and set it in the vertical position (button-up)
- Press and hold the button until the LED lights up
- release the button
- after releasing the button, the tedee lock will confirm the factory reset with three quick red flashes
- tedee lock will restart (it may take up to one minute)



**TEDEE LOCK
(VERTICAL POSITION)**



Note: Remember to set the tedee lock in a vertical position (button up).

additional and technical information

technical specifications

| | | | | |
|---------------------------|--|--------------------------|---------------------------------|--|
| Models | TLV1.0, TLV1.1 | Power supply | 3000 mAh LiPo battery | |
| Weight | ca. 196g | Bluetooth® communication | BLE 5.0 2,4GHz | Applies to: TLV1.0 and TLV1.1 |
| Dimensions | Φ 45mm x 55mm | | | |
| Operating temperature | 10-40°C (indoor only) | Security | TLS 1.3 | |
| Operating humidity | maximum 65% | Can be paired with | tedee bridge | |
| Origin | Poland, EU | Can be installed on | Euro-profile cylinders | Recommended: GERDA SLR modular cylinder |
| Production batch number | Additional information: The production batch number of your device is the first eight characters of the "Device Serial Number (S/N)" visible on the label on the package and the label on the device itself. For example, the production batch number of the device with the "Device Serial Number (S/N)" 10101010-000001 is 10101010. | | | |
| Marking of color variants | The color variant of the product is marked with a letter at the end of the model name, on the label and on the product rating plate. For example, a device with model TLV1.0 in color variant A is marked as "TLV1.0A". | | | |

radio frequency

Tedee lock TLV1.0 is equipped with Bluetooth® BLE 5.0 2,4GHz radio interface. Bluetooth® interface is used in communication between tedee lock, tedee bridge, and smartphones.

radio frequency

| Interface: | Frequency range: | Applies to models: |
|---------------------------|-------------------------|--------------------|
| Bluetooth® BLE 5.0 2,4GHz | from 2.4GHz to 2.483GHz | TLV1.0, TLV1.1 |



Micro USB Cable

| | |
|---------|-----------------|
| Product | Micro USB Cable |
| Weight | ca. 30g |
| Length | 1.5m or 2.0m |

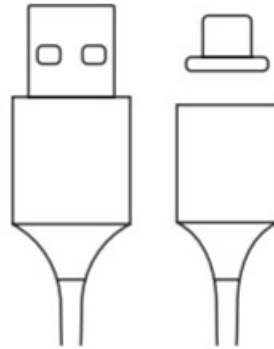

power supply, battery, and charging

The lock is equipped with a non-replaceable LiPo 3000mAh battery. It can be recharged using a micro USB cable connected to a power source such as a power bank or laptop. Battery life and charging time may vary depending on use, type of power supply, and environmental conditions. A preview of the battery charge status is shown directly in the tedee application. The tedee application notifies you when the battery is fully charged, after which it is recommended to disconnect the device from the power source. To prolong the life of the battery, it is not recommended to use it in temperatures beyond 10-40°C range.

It is recommended to charge the battery every three months if the lock is not used regularly.



software

The current software version is visible in the tedee application: device/settings/general/software version.

Tedee lock software can be updated in two ways: automatically or manually. Automatic updates are only available when the lock is connected to the tedee bridge which is connected to the Internet via a local Wi-Fi network.

If the lock is not connected to tedee bridge, you may update the software manually using tedee application: device settings/general/firmware version.

Please report any problems with the application that may occur during use (such as login errors or application hangs) to tedee technical support by email at support@tedee.com, at www.tedee.com/support, or by phone at (+48) 884 088 011 Monday to Friday during business hours from 8:00 to 16:00 (CET).

LED signals

| Meaning (action) | LED (color) | Signal (type) | Additional information |
|---------------------|----------------|------------------|------------------------|
| | | | |

| | | | |
|------------------|----------------------------|-----------------------|---|
| Initialization | Green | Flashing (fast) | LED flashes after turning on the device. It confirms the initialization process and system check-up completion. |
| Ready | Red – Blue – Green – White | Flashing (sequential) | LED flashes after successful initialization of the device . It confirms that your tedee lock is ready to use. |
| Unlocking | Green | Constant | Green LED is turned on while unlocking. (OFF if the battery level is low) |
| Locking | Red | Constant | Red LED turned on during the locking phase. (OFF if the battery level is low) |
| Jammed | Red | 5 flashes | LED flashes red when the tedee lock is jammed and needs attention. Please check if your device is calibrated correctly – if the problem persists, contact the tedee support team. |
| Device shutdown | Red | Pulsating light | LED flashes after 5 seconds of pressing the button and keeps pulsating until the device is shut down. It confirms the shutdown process. |
| Factory reset | Red | Pulsating light | The LED blinks with three quick red flashes when the button is released. This confirms that the factory settings have been restored. |
| Low battery | Red | 3 flashes x 3 times | LED flashes when battery drops below 15%. The flashing appears after every locking / unlocking operation. Your tedee lock requires charging. |
| Battery charging | Blue | Constant | LED shines blue and then fades out after 10 seconds. |

| | | | |
|-----------------|------|-----------------------|---|
| Delayed locking | Blue | Flashing | LED flashes fast after pressing and holding the button for at least 1 second (and no longer than 5 seconds). Available only if delayed locking option is ON in tedee app. |
| Calibration | Blue | Flashing | LED flashes blue during the calibration phase. |
| Error | Red | Flashing (fast /slow) | Please contact tedee support team. |

legal/environmental notes



EU Declaration of Conformity

Tedee Sp. z o.o. hereby declares that the Tedee Lock TLV1.0 radio device is in accordance with Directive 2014/53/EU. The full text of the EU Declaration of Conformity is available at the following internet address: www.tedee.com/compliance WEEE/RoHS

To prevent potential negative impact on the environment, consult your local laws and regulations for the proper disposal of electronic devices and batteries in your country. Disposal of batteries – if your tedee device contains batteries, do not dispose of them with regular household waste. Hand them over to the appropriate recycling or collection point. Batteries used in tedee devices do not contain mercury, cadmium, or lead above the levels specified in the 2006/66/EC Directive. Disposal of electronics – do not dispose of your tedee device with regular household waste. Hand it over to the appropriate recycling or collection point.

Bluetooth® The Bluetooth® word mark and logos are owned by the Bluetooth SIG, Inc. and any use of such marks by Tedee Sp. z o.o. is under license. Other trademarks and trade names are those of their respective owners.

Google, Android, and Google Play are trademarks of Google LLC.

Apple and App Store are trademarks of Apple Inc. IOS is a trademark or registered trademark of Cisco in the U.S. and other countries and is used under license.



warranty

Tedee limited hardware warranty – Tedee Sp. z o.o. warrants that tedee devices are free from hardware defects in materials and workmanship for a period of not less than 2 years from the date of the first retail purchase. Tedee Sp. z o.o. does not take responsibility for the misuse of devices (including methods of charging other than described in this booklet), especially if any changes or modifications to the device hardware or software which are not approved, recommended, or provided by tedee, have been undertaken by the user. Full warranty information is available at the following link: www.tedee.com/warranty



technical support

For technical support please contact our support team

| | | |
|---|--|--------------------------------------|
|  |  | |
| support@tedee.com | www.tedee.com/support | (+48) 884 088 01 Mon-Fri 8am – 4p |

tedee

Tedee Sp. z o.o. | ul. Altowa 2, 02-386 Warszawa, POLAND

www.tedee.com | support@tedee.com

your activation code (AC)

Note: the activation code is case-sensitive. When typing it in, please pay attention to capital / small letters.

Documents / Resources

| | |
|--|---|
|  | <p>tedee TLV1.0 [pdf] Installation Guide TLV1.0, TLV1.1, Smart Door Lock Built in Battery</p> |
|--|---|

References

- [Installation | tedee](#)
- [Smart door lock | Make door smart | tedee](#)
- [Declaration of Conformity | tedee](#)
- [Get support | tedee](#)
- [Warranty | tedee](#)

Related Posts

[WE LOCK PCB10KEY31 Door Smart Lock Installation Guide](#)



PCB10KEY31 Door Smart Lock

[GENTILI LADDER LOCK Installation Guide](#)



TECHNOLOGY EQUIPMENT Ladder Lock parts Remove the rear end cap and the closest ladder retainerInsert the Ladder Lock following...

[Yale Unity Entrance Lock Installation Guide](#)



Yale Unity Entrance Lock Installation Guide Unity Entrance Lock
Installation Template Unity Entrance Lock Installation Template ...



[IKEA Nordli Installation Guide](#)

NORDLI