



# SKYDANCE PF1 4-Key Panel RF Remote Controller User Manual

[Home](#) » [SKYDANCE](#) » SKYDANCE PF1 4-Key Panel RF Remote Controller User Manual 



**4-Key Panel RF Remote Controller**  
**Model No.: PF1, PF1-2, PF2, PF3**

**4-key panel/1-4 color/Wireless remote 30m distance/CR2032 battery**



PF1  
1 Zone Dimming



PF1-2  
2 Zone Dimming



PF2  
1 Zone CCT



PF3  
1 Zone RGB/RGBW

CE RoHS  LVD RED

## Contents

- [1 Features](#)
- [2 Technical Parameters](#)
- [3 Mechanical Structures and Installations](#)
- [4 Key function](#)
- [5 Match Remote Control \(two match ways\)](#)
- [6 Safety information](#)
- [7 Documents / Resources](#)
  - [7.1 References](#)
- [8 Related Posts](#)

## Features

- Apply to single color, dual color or RGB/RGBW LED controller.
- Each remote can match one or more receivers.
- CR2032 battery powered.
- Removeable and stick anywhere easily, or mount on wall use panel base.

## Technical Parameters

### Input and Output

Output signal	RF (2.4GHz)
Working voltage	3VDC (CR2032)
Working current	5mA
Standby current	2 $\mu$ A
Standby time	2 years
Remote distance	30m(Barrier-free space)

### Environment

Operation temperature	Ta: -30 O C ~ +55 O C
IP rating	IP20

### Safety and EMC

EMC standard (EMC)	ETSI EN 301 489-1 V2.2.3 ETSI EN 301 489-17 V3.2.4
Safety standard(LVD)	EN 62368-1:2020+A11:2020
Radio Equipment(RED)	ETSI EN 300 328 V2.2.2
Certification	CE,EMC,LVD,RED

## Warranty

Warranty	5 years
----------	---------

## Weight

Gross weight	0.057kg
Net weight	0.075kg

## Mechanical Structures and Installations

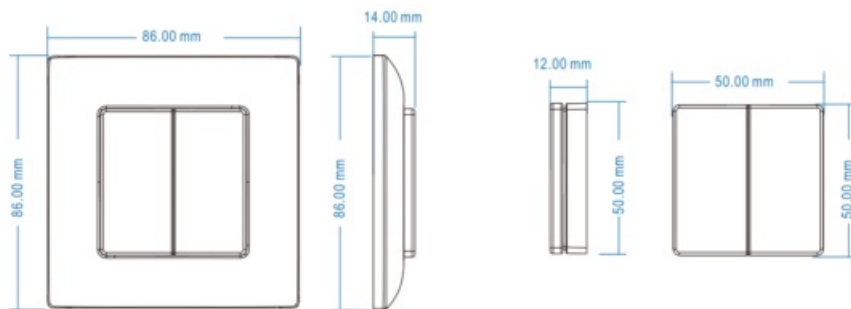

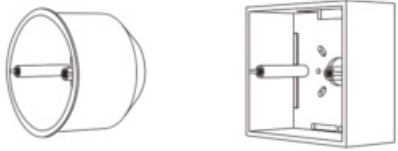
Replace battery:	Typical base as below:
 <p>CR2032 Battery</p> <p>Note: Before the first use, please remove the protective film on the battery.</p>	 <p>European style</p> <p>86 size</p>

## Installation diagram:

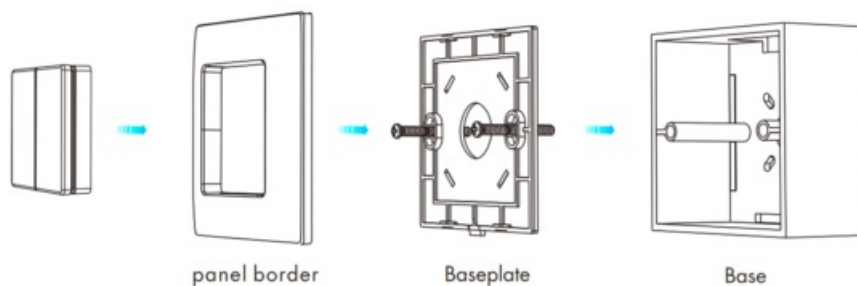

To fix the panel, two options are offered for selection:

Option 1: fix it on the wall with two screws.

Option 2: adhere it to the wall with paster.

## Key function

- PF1 Single color dimming remote

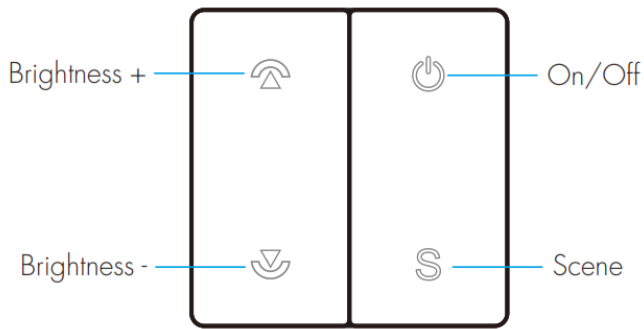

**On/Off:** Turn on or off light.

**Brightness+/-:** Adjust brightness.

Short press 10 levels,

long press 1-6s for continuous 256 levels adjustment.

**Scene:** Brightness memory.

Short press recall the scene,

long press 2s save the current brightness into the scene.

● **PF1-2 2 zone single color dimming remote**

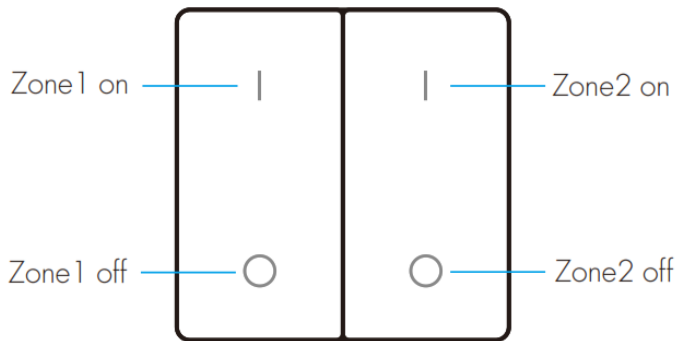

**Zone 1-2 on:**

Short press turn on zone light,

long press 1-6s to increase brightness continuously.

**Zone 1-2 off:**

Short press turn off zone light,

long press 1-6s to decrease brightness continuously.

● **PF2 Color temperature remote**

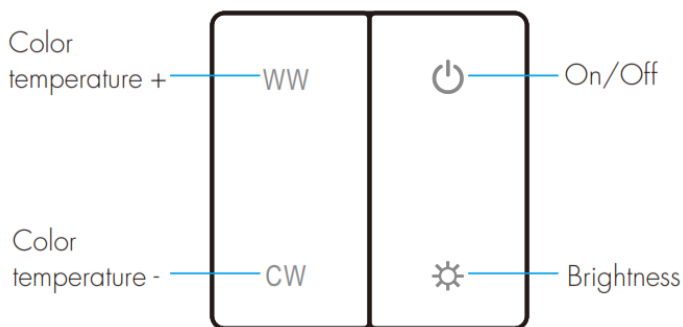

**On/Off:** Turn on or off light.

**Brightness:** Adjust brightness.

Short press 10 levels,

long press for continuous 256 levels adjustment.

**Color temperature+/-:** Adjust color temperature.

Short press 11 levels,

long press 1-6s for continuous 256 levels adjustment.

● **PF3 RGB/RGBW remote**

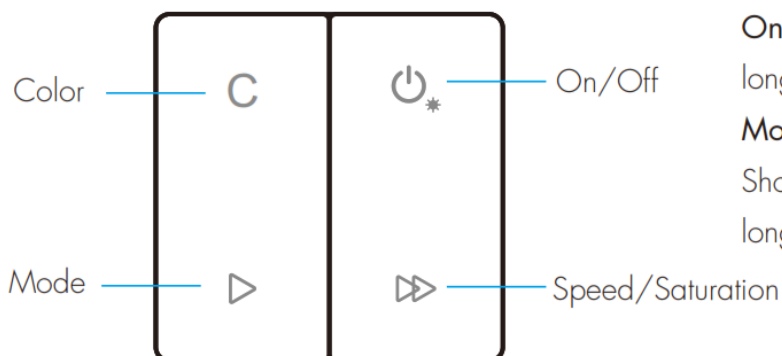

**On/Off:** Short press turn on or off light,

long press 1-6s to adjust brightness continuously.

**Mode:** Change dynamic mode.

Short press run next mode,

long press 2s run mode-cycle.

**Color:** Change static RGB color.

Short press get 24 kinds static color, long press for continuous static color adjustment.

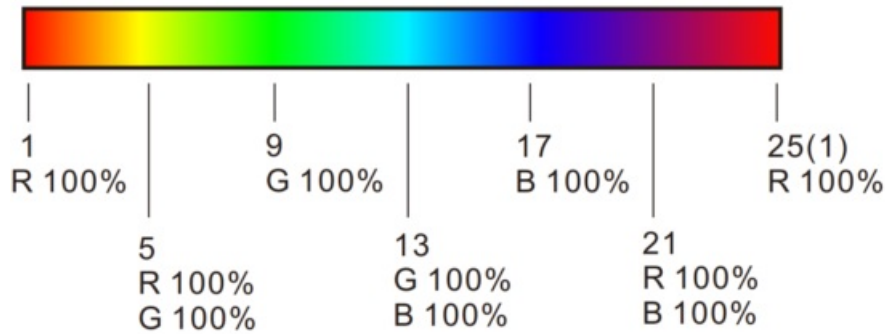

### Speed / Saturation:

For dynamic mode, adjust speed.

Short press 10 levels, long press 2s get the default speed.

For static color, adjust saturation, namely change current static color to mixed white slowly.

Short press 11 levels, long press 1-6s for continuous 256 levels adjustment.

### RGBW light:

long press Mode + Speed/Saturation key to adjust W channel brightness simultaneously.

### Match Remote Control (two match ways)

End user can choose the suitable match/delete ways. Two options are offered for selection:

Use the controller's Match key

Match:

Short press match key, immediately press on/off key on the remote.

The LED indicator fast flash a few times means match is successful.

Delete:

Press and hold match key for 5s to delete all match, The LED indicator fast flash a few times means all matched remotes were deleted.

### Use Power Restart

Match:

Switch off the power, then switch on power, and repeat again.

Immediately short press on/off key 3 times on the remote.

The light blinks 3 times means match is successful.

Delete:

Switch off the power, then switch on power, repeat again.



Immediately short press on/off key 5 times on the remote.

The light blinks 5 times means all matched remotes were deleted.

### Safety information

1. Read all instructions carefully before you begin this installation.
2. When installing battery, pay attention to the battery positive and negative polarity. A long time without the remote control, remove the battery.  
When remote distance becomes smaller and insensitive, replace the battery.
3. If no response from the receiver, please re-match the remote.
4. Gently handle remote, beware of falling.
5. For indoor and dry location use only.

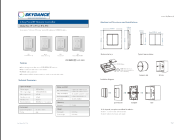
## Documents / Resources

	<p><a href="#">SKYDANCE PF1 4-Key Panel RF Remote Controller</a> [pdf] User Manual PF1, PF1-2, PF2, PF3, PF1 4-Key Panel RF Remote Controller, 4-Key Panel RF Remote Controller</p>
	<p><a href="#">SKYDANCE PF1 4 Key Panel RF Remote Controller</a> [pdf] User Manual PF1, PF1-2, PF2, PF3, PF1 4 Key Panel RF Remote Controller, 4 Key Panel RF Remote Controller, Panel RF Remote Controller, RF Remote Controller, Remote Controller, Controller</p>

## References

- [🌐 Sklep ELED - oświetlenie LED na miarę Twoich potrzeb](#)

[Manuals+](#)