

# PUNQTUM Q-Series Network Based Intercom System User Manual

[Home](#) » [PUNQTUM](#) » PUNQTUM Q-Series Network Based Intercom System User Manual 

## Contents

- [1 PUNQTUM Q-Series Network Based Intercom System](#)
- [2 Product Information](#)
- [3 Preface](#)
- [4 Information](#)
- [5 About punQtum Q-Series Digital Partyline Intercom System](#)
- [6 Operating Elements](#)
- [7 Getting Started](#)
- [8 Using your Beltpack](#)
- [9 Menu operation](#)
- [10 Connector Pinout](#)
- [11 Documents / Resources](#)
  - [11.1 References](#)
- [12 Related Posts](#)



**PUNQTUM Q-Series Network Based Intercom System**

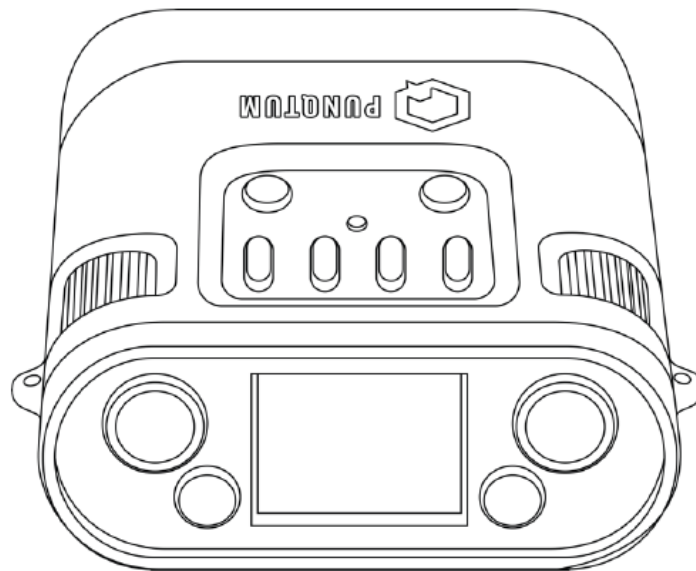

## Specifications

- Product: Q-Series Network Based Intercom System
- Manufacturer: PUNQTUM
- Firmware Version: 2.0

## Product Information

The Q-Series Network Based Intercom System by PUNQTUM is a digital partyline intercom system designed for professional communication needs.

## Operating Elements

The system features various operating elements including power buttons, volume controls, and menu navigation buttons for easy operation.

## Getting Started

To power up the system, follow the specific instructions based on your desired setup – Star Topology or Daisy Chain. Ensure proper connection and configuration for optimal performance.

## Using Your Beltpack

The beltpack allows users to adjust volume levels using the volume button and switch between different communication channels using the alternate page button.

## Menu Operation

The menu offers options such as resetting local changes, saving personal settings, loading personal settings, and performing a factory reset. These functions help customize the user experience.

## FAQ

### 1. **Q: How do I update the firmware of the Q-Series Intercom System?**

A: To update the firmware, visit the manufacturer's website at [www.punqtum.com](http://www.punqtum.com) and download the latest firmware version. Follow the provided instructions for firmware update.

### 2. **Q: Can I use the Q-Series Intercom System for outdoor events?**

A: The Q-Series Intercom System is primarily designed for indoor use. While it may work for outdoor events

under certain conditions, it is recommended to protect the system from moisture and extreme temperatures.

## [WWW.PUNQTUM.COM](http://WWW.PUNQTUM.COM)

This manual is applicable for the Firmware Version: 2.0

© 2024 Riedel Communications GmbH & Co. KG. All rights reserved. Under the copyright laws, this manual may not be copied, in whole or in part, without the written consent of Riedel. Every effort has been made to ensure that the information in this manual is accurate. Riedel is not responsible for printing or clerical errors. All trademarks are the property of their respective owners.

## Preface

Welcome to the punQtum digital intercom family!

This document provides detailed information about the punQtum Q-Series digital partyline system, pin outs, mechanical and electrical data.

## NOTICE

This manual, as well as the software and any examples contained herein are provided “as is” and are subject to change without notice. The content of this manual is for informational purposes only and should not be construed as a commitment by Riedel Communications GmbH & Co. KG. or its suppliers. Riedel Communications GmbH & Co. KG. gives no warranty of any kind with regard to this manual or the software, including, but not limited to, the implied warranties of marketability or fitness for a particular purpose. Riedel Communications GmbH & Co. KG. shall not be liable for any errors, inaccuracies or for incidental or consequential damages in connection with the furnishing, performance or use of this manual, the software or the examples herein. Riedel Communications GmbH & Co. KG. reserves all patent, proprietary design, title and intellectual property rights contained herein, including, but not limited to, any images, text, photographs incorporated in the manual or software.

All title and intellectual property rights in and to the content that is accessed through use of the products is the property of the respective owner and is protected by applicable copyright or other intellectual property laws and treaties.

© 2024 Riedel Communications GmbH & Co. KG. All rights reserved. Under the copyright laws, this manual may not be copied, in whole or in part, without the written consent of Riedel.

All trademarks are the property of their respective owner.

## Information

### Symbols

The following tables are used to indicate hazards and provide cautionary information in relation to the handling and use of the equipment.



This text indicates a situation that needs your close attention. It may also be used to alert against unsafe practices.



This text is for general information. It indicates the activity for ease of work or for better understanding.

### Service

- All service must be provided ONLY by qualified service personnel.
- There are no user-serviceable parts inside the devices.
- Do not plug in, turn on or attempt to operate an obviously damaged device.
- Never attempt to modify the equipment components for any reason.

All adjustments have been done at the factory before the shipment of the devices. No maintenance is required and

no user-serviceable parts are inside the unit.

## Environment

- Never expose the device to high concentrations of dust or humidity.
- Never expose the device to any liquids.
- If the device has been exposed to a cold environment and transferred to a warm environment, condensation may form inside the housing. Wait at least 2 hours before applying any power to the device.

## Disposal



■ This symbol, found on your product or on its packaging, indicates that this product should not be treated as household waste when you wish to dispose of it. Instead, it should be handed over to an authorized collection point for the recycling of electrical and electronic equipment. By ensuring this product is disposed of correctly, you will help prevent potential negative consequences to the environment and human health, which could otherwise be caused by inappropriate disposal of this product. The recycling of materials will help to conserve natural resources. For more detailed information about the recycling of this product please contact the local authority responsible.

## About punQtum Q-Series Digital Partyline Intercom System

punQtum Q-Series digital partyline intercom system is a digital, easy to use, full-duplex communications solution for theater and broadcast applications as well as for all kinds of cultural events like concerts, etc. It is an all-new, network-based partyline intercom system which combines all standard partyline system features including wireless access and more with the advantages of modern IP networks. punQtum Q-Series works on standard network infrastructure and is easy to install and set up. The system works “out of the box” with a factory default configuration but can be quickly configured by user-friendly software to meet individual needs.

The system is completely decentralized. There is no master station or any other central point of intelligence in the whole system. All processing is handled locally in each device except for the punQtum wireless Apps which require a punQtum Q210 PW Speaker Station to serve as a bridge to the Q-Series digital partyline intercom system. The capacity of one partyline intercom system is set to a maximum of 32 channels, 4 program inputs, up to 4 public announce outputs and 32 control outputs. Each punQtum Q210 PW Speaker Station serves up to 4 punQtum Wireless App connections. punQtum Q-Series digital partyline systems are based on Roles and I/O settings to ease the use and administration of partyline intercom systems. A Role is a template for the channel configuration of a device. This allows channel settings and alternate functions to be predefined for different Roles needed to run a live show. As an example, think of the stage manager, sound, light, wardrobe and security personnel having different communication channels available to deliver a perfect job.

An I/O setting is a template for the settings of the equipment connected to a device. This, for example, allows I/O settings to be available for different Headsets being used at a venue to cover for different environmental situations. Each device can be configured to any Role and I/O setting available. Multiple punQtum partyline intercom systems can share the same network infrastructure. This allows for the creation of production islands within a campus using the same IT network infrastructure. The number of devices (Beltpacks/Speaker Stations and Wireless Apps) is theoretically infinite but limited by the network capacity. Beltpacks are powered by PoE, either from a PoE switch or from a Speaker Station. They can be daisy-chained to reduce wiring efforts on site.

Beltpacks and Wireless Apps support simultaneous use of 2 channels with separate TALK and CALL buttons as well as one rotary encoder for each channel. An alternate page button allows the user to quickly reach alternate functions such as public announce, Talk To All, Talk To Many, to control general purpose outputs and access system functions like Mic Kill asf. The Beltpack is designed with a combination of premium materials, including high-impact plastics and rubber to make it both tough and comfortable to use in any situation. punQtum Q-Series

Beltpacks, Wireless Apps and Speaker Stations allow users to replay missed or not understood messages. Program input signals can be fed into the system using an analog audio input at any Speaker Station. Sunlight readable, dimmable RGB color displays used for Beltpacks and Speaker Stations make for excellent readability of the intuitive user interface.

## Operating Elements

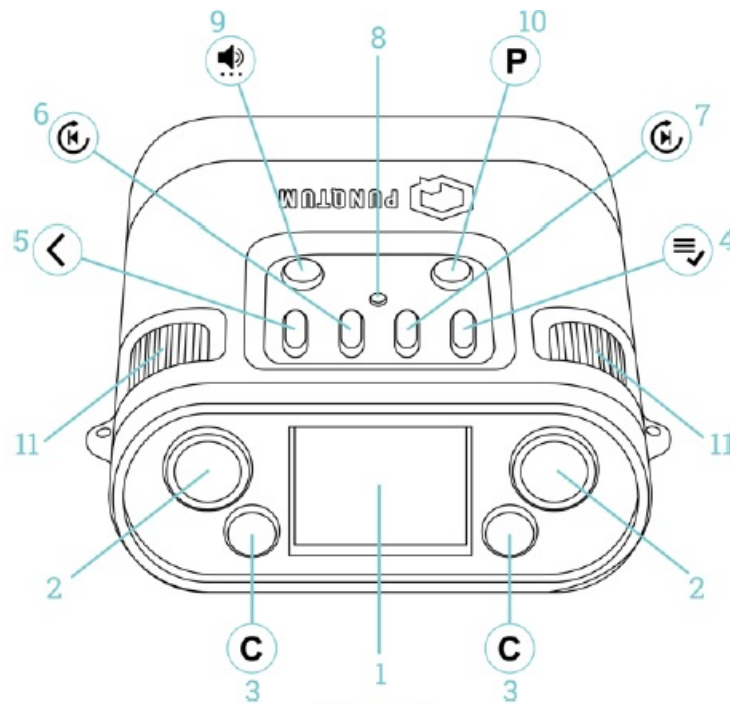

Figure 1

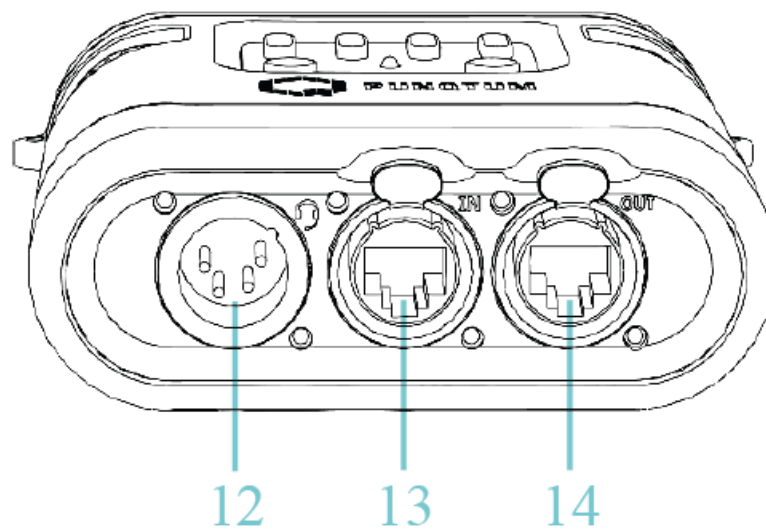

Figure 2

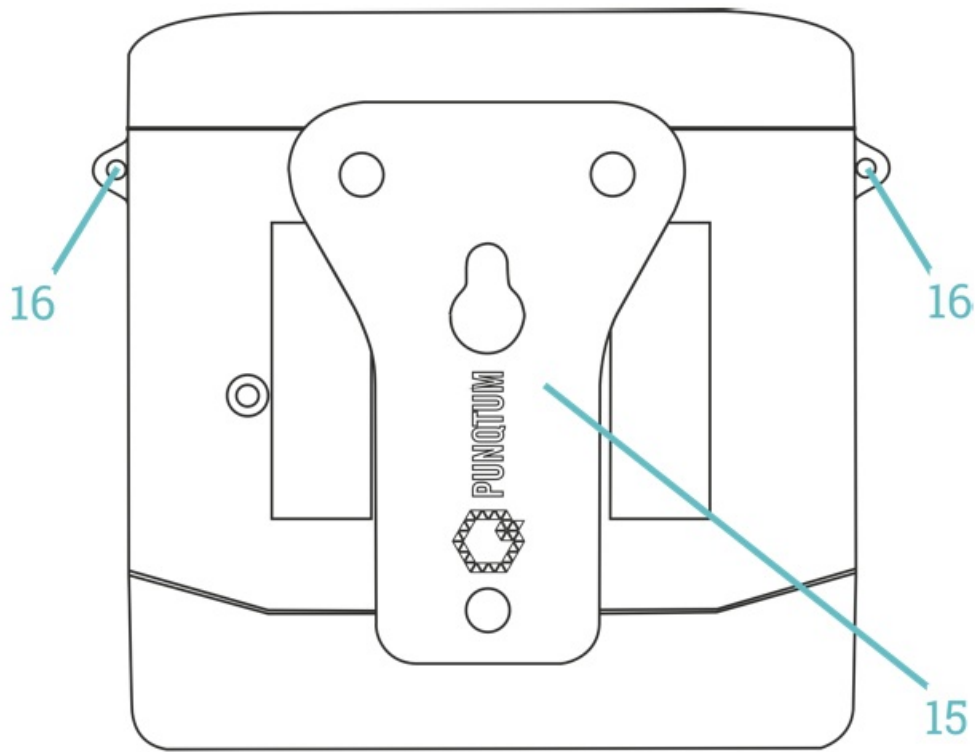

Figure 3

1. Color TFT display
2. TALK buttons
3. CALL buttons
4. MENU / OK button
5. BACK button
6. REPLAY / SKIP BACK button
7. REPLAY / SKIP FORWARD button
8. Finger position marker
9. VOLUME button
10. Alternate page button
11. Rotary Encoders
12. Headset connector
13. Network & PoE input
14. Network & PoE output (pass through)
15. Beltclip
16. Lanyard or safety cord mounting holes

## Getting Started

The Q110 Beltpack is delivered with a factory default system configuration and will work “out of the box”. The Beltpack supports monaural headsets with a dynamic or electret microphone.

## Powering Up

The Beltpack is powered by any PoE-compliant (IEEE 802.3af, 3at or 3bt) power supply. Regular PoE switches or PoE injectors can be used as well as a punQtum Q210P Speakerstation or another Q110 Beltpack.

## Star Topology

Star topologies using Ethernet switches are preferred to daisy-chained networks.

### Daisy Chain

Although punQtum Beltpacks can be intelligent and reliably daisy-chained, please note that the number of daisy-chained Q110 units is limited by the available PoE power budget, Ethernet cable length and quality.

**The number of Q110 daisy-chained are set to a maximum of:**

- PoE port comply with PoE+ standard (802.3 at): **4 Beltpacks**  
(100m cable length between each device, cable AWG26)
- PoE port comply with standard (802.3 bt): **8 Beltpacks**  
(100m cable length between each device, cable AWG18)

**One or more Q110 powered by a PoE switch:**

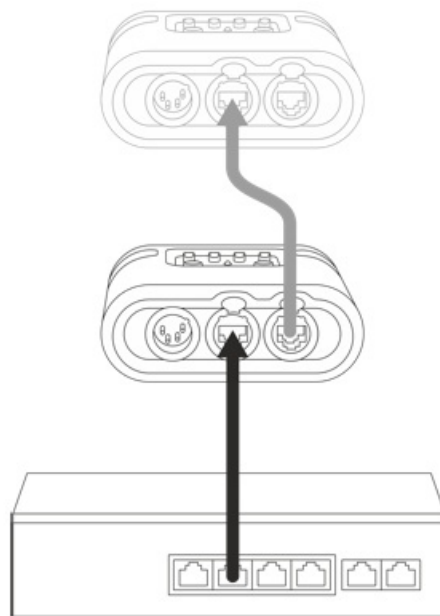

**One or more Q110 powered by a punQtum Q210P Speakerstation:**

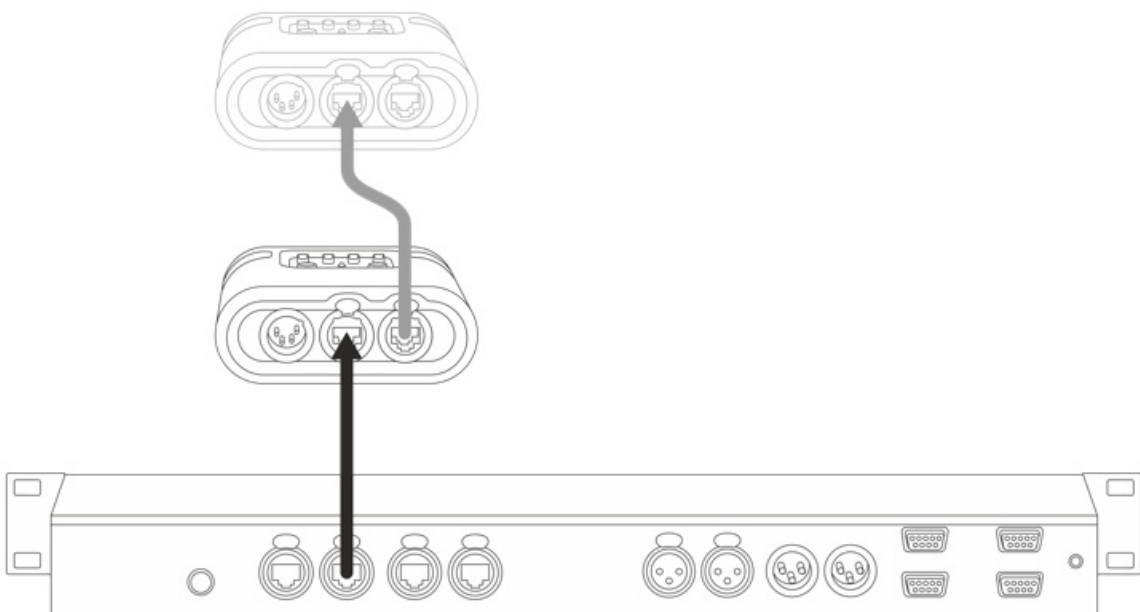

## One or more Q110 powered by a PoE injector:

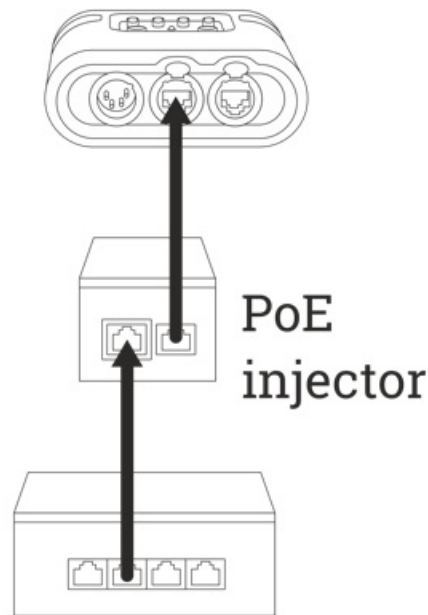

Connect your headset, press TALK and enjoy.

### **Multicast Audio Streams**

If you do not have any other audio streams present in your network infrastructure, you will most probably be fine. If you are using punQtum Q-Series digital partyline systems in networks together with other audio network streaming technologies such as Ravenna, DANTEM or other multicast-based streaming technologies, you need to make sure that your network infrastructure is capable of supporting IGMP (Internet Group Management Protocol) and that IGMP is correctly set up and configured:

If you use a single switch only, it is irrelevant if the switch has IGMP snooping (aka multicast filtering) enabled or not. As soon as you have two switches, and one or more switches happen to have IGMP snooping enabled, it is necessary to configure one and only one IGMP querier in the network (usually, you select one switch). Without an IGMP querier, the multicast traffic will stop after a while due to IGMP timeouts. punQtum Q-Series digital partyline system supports IGMP V2.

### **Using your Beltpack**

Once you have connected your Beltpack to the system, the Beltpack will use the defined Role from its memory. A Beltpack that is "new out of the box" will have a factory default Role. This way all Beltpacks will be able to find each other without the need of the Q-tool configuration software.

### **Main Display**

In normal operation the display will provide you with information on Channel A, Channel B and on the Network.



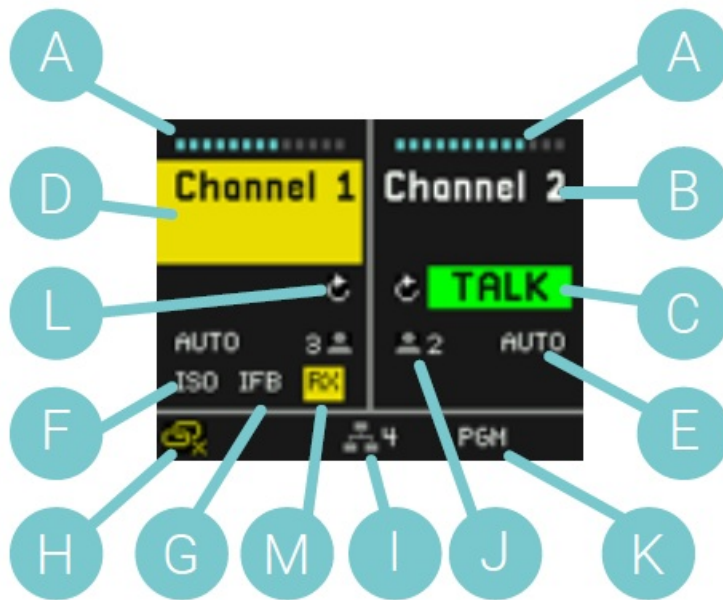

- A Channel Volume
- B Channel Name
- C TALK active indication
- D CALL active indication
- E TALK button operation mode
- F ISO active indication
- G IFB active indication
- H Daisy chain link indication
- I Partyline system device count
- J Channel user count
- K PGM indication
- L Replay available indication
- M Audio receive indication

**Channel Volume (A)** 

Channel volume control can be set by the rotary encoder knobs (11 on Figure 2) on the side of the Beltpack. Moving the rotary knob clockwise will increase the volume, counter-clockwise operation will decrease the volume.

**Channel Name (B)** 

The Channel Name shown is the Name as defined in the configuration of Q-Tool.

**TALK active indication (C)** 

An active TALK function is indicated in the display per Channel. Use the TALK Buttons (item 2 on Figure 2) to switch on and off the TALK status of each Channel.

**CALL active indication (D)** 

If a CALL signal is received on a Channel, the display will show a yellow flashing square on the Name of the Channel. A CALL buzzer signal will be heard at the same time.

If the CALL signal remains active for more than two seconds the display will flash with a larger section of the Channel. At the same time, a different buzzer signal will be heard. The volume of the buzzer signal can be

changed individually on each device, see 0

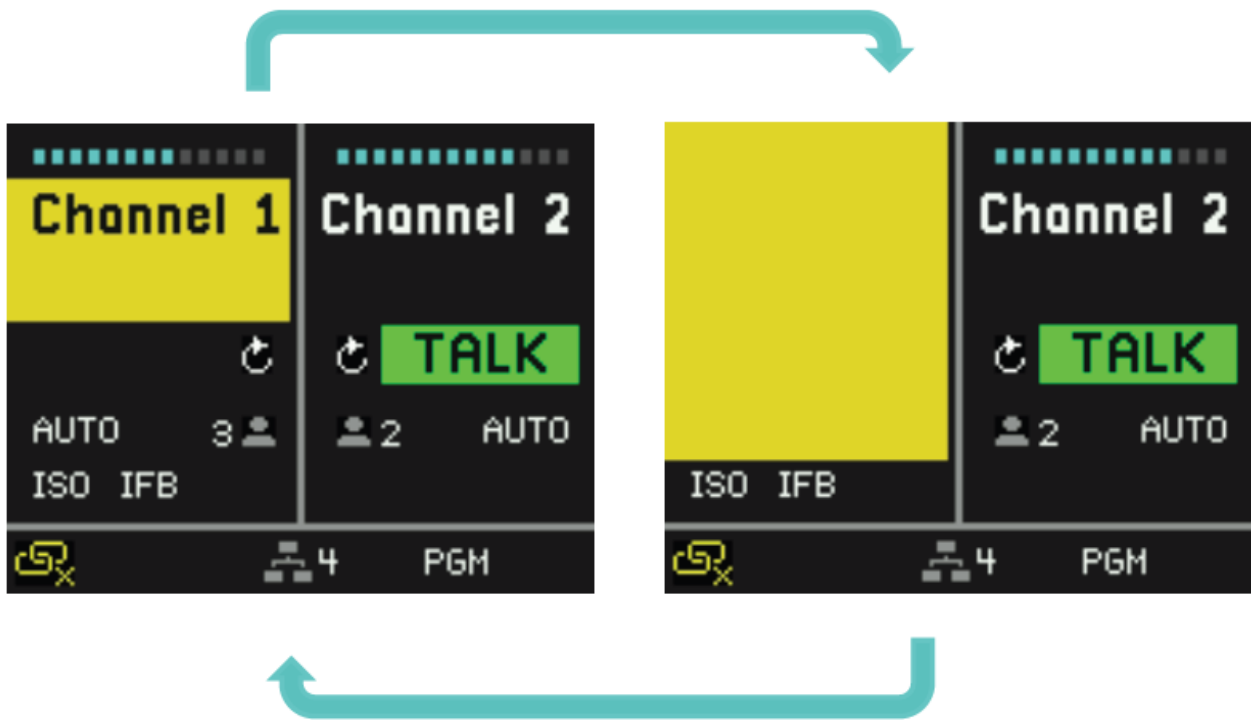

### TALK Button operation modes (E) **AUTO**

The TALK button offers three operation modes.

#### 1. AUTO, a double function:

- Push the TALK button momentarily, the TALK function is now latched On.
- Push the TALK button momentarily, the TALK function is now Off.
- Push and hold the TALK button, the TALK function is active as long as the TALK button is held, when the TALK button is released the TALK function is switched Off.

#### 2. LATCH:

- Push the TALK button momentarily, the TALK function is now latched On.
- Push the TALK button momentarily, the TALK function is now Off.

#### 3. PUSH:

- Push and hold the TALK button, the TALK function is active as long as the TALK button is held, when the TALK button is released the TALK function is switched Off.

TALK button operation mode can be set using the configuration software.

**AUTO LATCH** If the operation mode is displayed in orange, quiet environment mode is active for the respective channel.

### ISO active indication (F) **ISO**

The symbol ISO indicates an active Isolate function. When you activate the TALK button of that Channel you will only hear the users of that Channel, audio from other Channels you receive is muted.

### IFB active indication (G) **IFB**

The symbol IFB indicates an active Interrupt Fold Back. The program input signal level is dimmed by the amount specified in a Role if someone is speaking on the channel.



### Daisy Chain Link indication (H)

This symbol indicates that you cannot power another Beltpack from your device.

Your Beltpack calculates the available power as a result of the power provided from your PoE device and the number of units already connected.



### Partyline system device count (I)

Shows the number of units participating in your partyline system. If the symbol is shown in red, your device is the only one in the system.



### Channel User Count (J)

Shows the number of users available on this channel. If the symbol is shown in red, you are the only user of this channel.



### PGM indication (K)

The PGM symbol indicates a selected program input. If the symbol is shown in white the program input is received, if red, the program input is not received. Program inputs are only available if configured on a punQtum Q210P Speakerstation as part of the partyline system.



### Replay available indication (L)

The recorded messages can be replayed by pushing the Replay buttons on the top of the Beltpack.

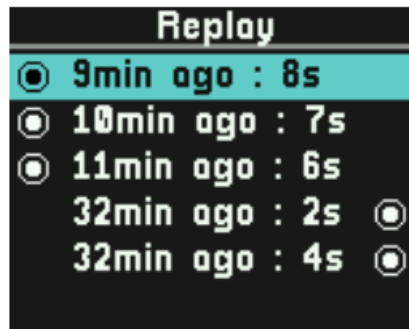

By pushing either of the Replay buttons on top of the Beltpack, the last recorded message will be played back immediately.

Use the Replay buttons on top of the Beltpack to scroll through the list. You can see how long ago each message was recorded, how long each recorded message is and the dot shows which Channel each was recorded from. While playing back you may use the Channel Volume Encoders to adjust the volume of the playback.

A long press on the back button will delete all recorded messages. Replay indication will be shown if there is a recording present on that Channel. If message recording is disabled in Q-Tool, the replay available indication is

crossed out.



### Audio receive indication (M)

The yellow RX indication is shown if audio is being received on the channel.

### Volume Button

Pressing the Volume Button  will cycle you through all available volume settings.



You may adjust each volume setting using any rotary encoder. Your settings are stored in your Beltpack.

- Master volume sets the overall volume for your Beltpack.
- Program volume controls the volume of your program input.
- Buzzer volume controls the volume of the CALL signals.
- Sidetone volume controls the volume of your own voice.

If your Beltpack is in normal operation mode, the rotary encoders will control the listening volume of the active channels.

### Alternate Page Button

Pressing the Alternate Page Button  will temporarily give access to functions like public announce, Talk To All and Talk To Many, control outputs switching, System Mute, System Silent and Mic Kill. You can assign a maximum of 4 functions to this page using Q-tool configuration software.

A second press on the Alternate Page button or a press on the Back button will leave the alternate page. If no functions are assigned to the alternate page, the Alternate Page button is inactive.

### Public Announce, Talk to All & Talk to Many functions

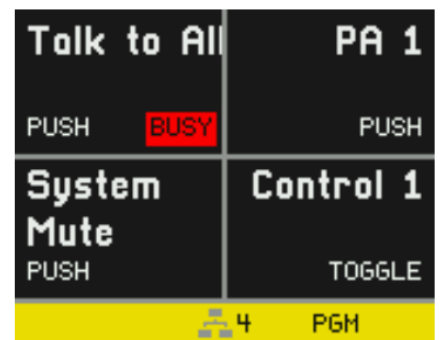
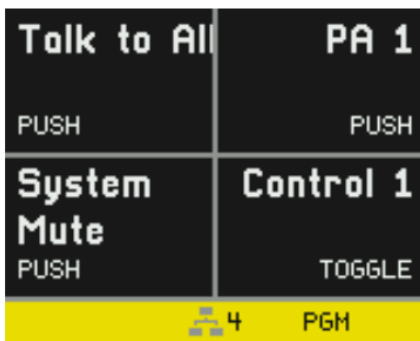

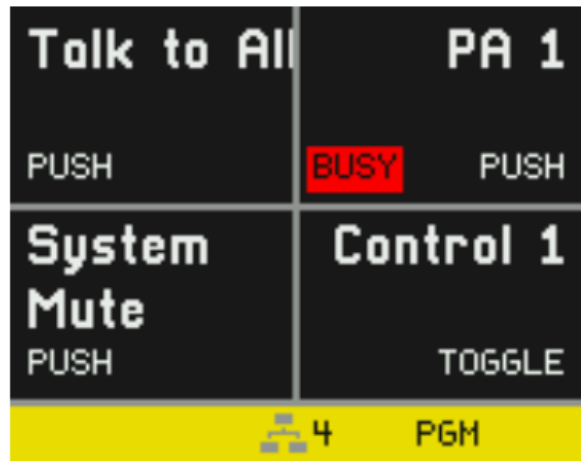
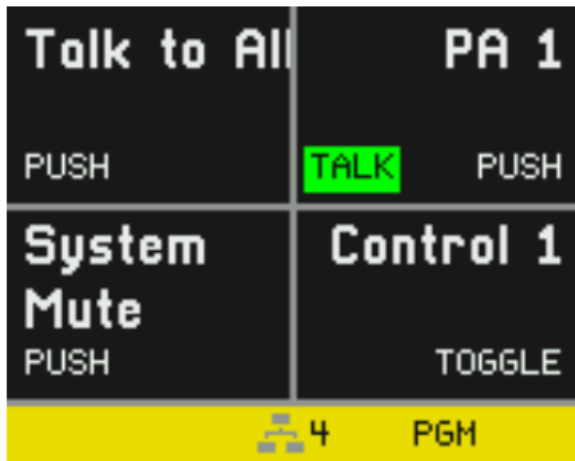

The assigned function can be activated by pressing the TALK or the CALL button near the quadrant. The display will show a green TALK indication or a red BUSY indication if someone else is already using this function. Once the other user disables his TALK function, your TALK will show green and you can talk. For TALK button modes see 4.4.5.

### Control Outputs switching P

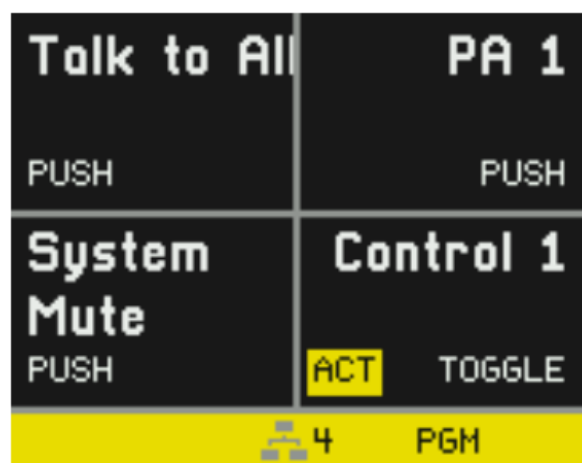
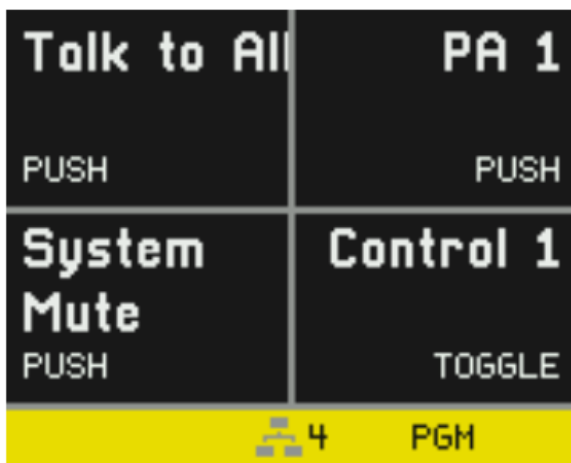

Control outputs are part of the Q210P Speakerstation product, but can be controlled from any device in the system. If the output is active you will see a yellow ACT indicator.

### System Mute function P

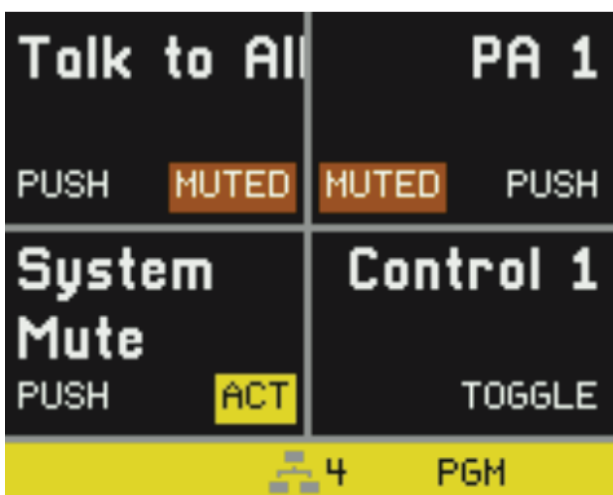

SYSTEM MUTE disables all CALL and TALK functions and mutes all program input signals and stays active as long as the Button is pressed (PUSH behavior). If System Mute is active you will be notified by an orange MUTED indicator.

### System Silent function P



System silent stops the speaker of the Q210P Speakerstation and any other (future) devices from making sound. Public announcements remain functional, optical signaling when using a CALL function remains functional as well. The function is activated through a button push. Pressing the button again deactivates the function (TOGGLE behavior). If system silent is active. you will be notified by an orange SILENT indicator.

### Mic Kill function P



Clicking the Mic Kill button on a device will reset all active TALK functions of the channels the device role is assigned to except for the TALK functions active on the device where Mic Kill is issued. A long press on the Mic Kill button will reset all active TALK functions of all channels available in the system configuration except for the TALK functions active on the device where Mic Kill is issued. The purpose of this function is to be able to ‘silence’ overly busy channels to be able to transmit important / urgent messages. Please note that the mic kill function is not applied to interface connections, because they are typically used to interconnect different communication systems. Mic kill functions can be propagated to and received from other systems using the GPIO ports on a punQtum Speaker Station.

### Menu operation

The Role and I/O setting define most of the settings for the user. Some of the items can be changed by the user

via the Menu. If items are locked in Q-Tool then they will not show.



Use this button to enter the menu, navigate thru the menu and to select an item.

A long press on the menu button briefly shows the device model, device name and installed FW version.



Use this button to do a step back in the menu and to exit the menu.

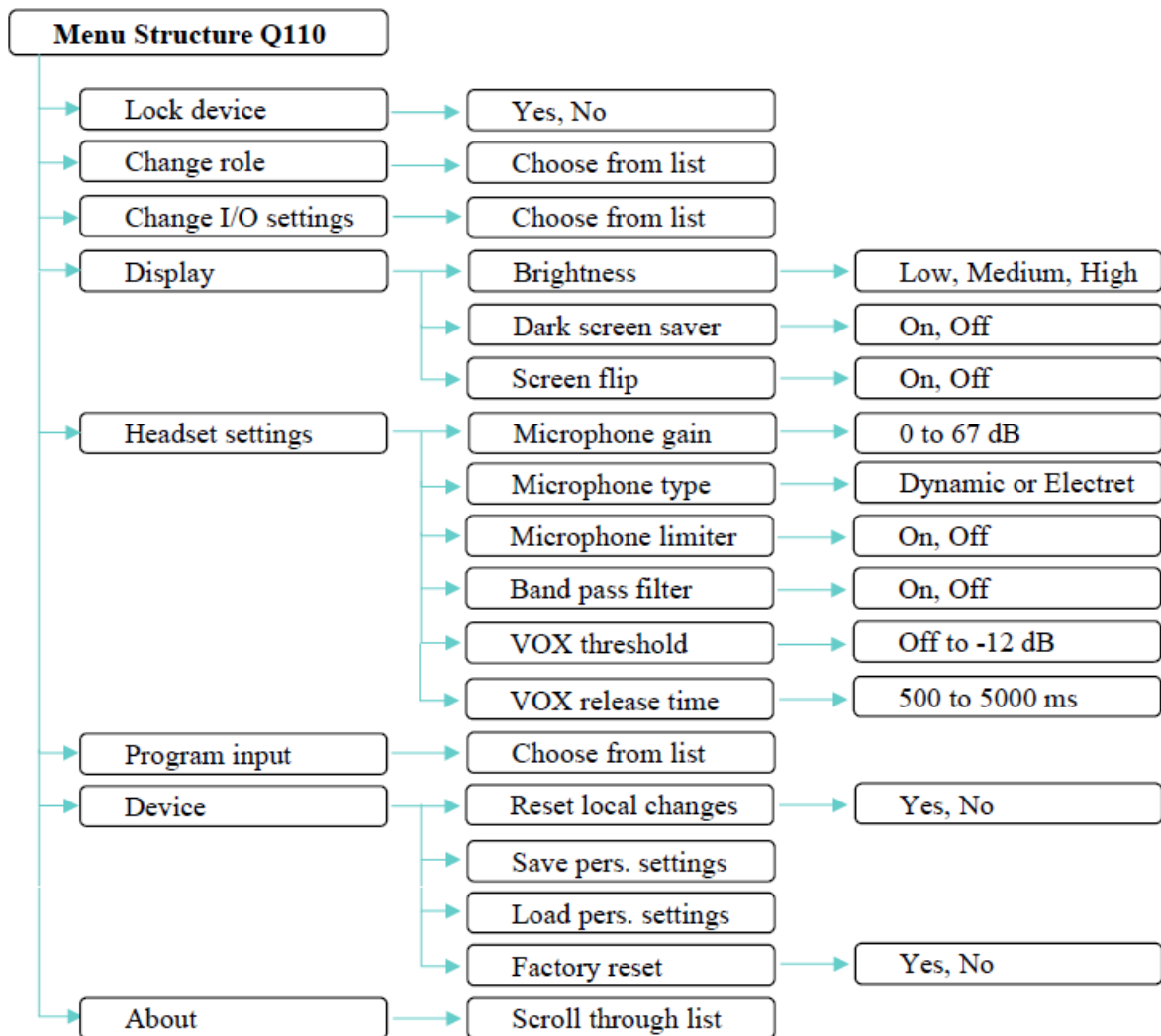

### Lock Device

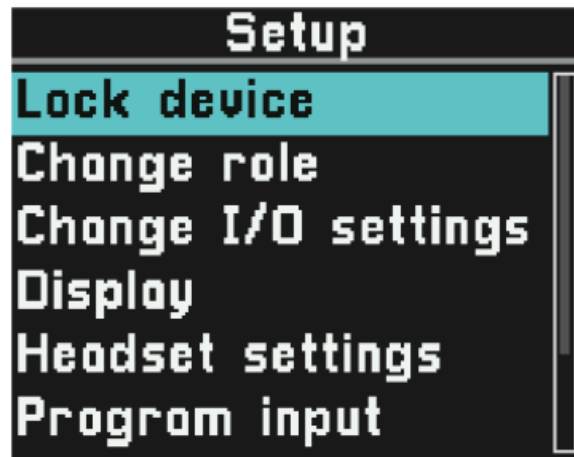

Role settings for your device may include an option to lock the front panel using a 4 digit pin. The pin is defined per Role in Q-Tool configuration software.

The lock device menu entry is only shown if the selected Role has an active lock front panel option.

Note that the factory default configuration does not include front panel locking.

To lock your device select 'Lock device' on your device. To unlock your device, enter the 4 digit pin in the lock screen and confirm the unlock.

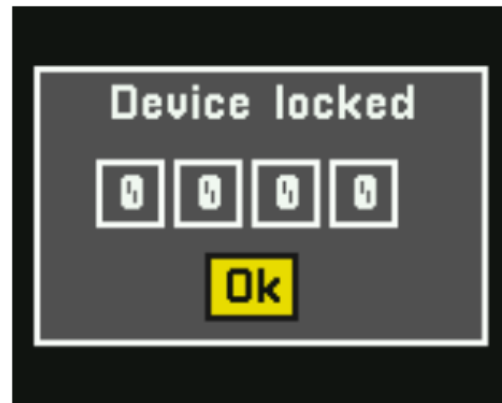
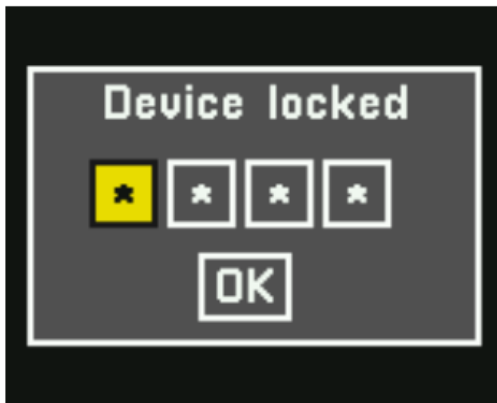

### Change Role

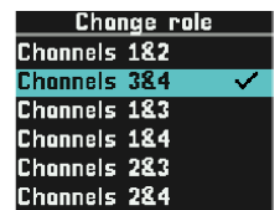
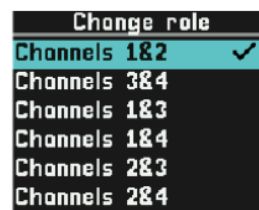
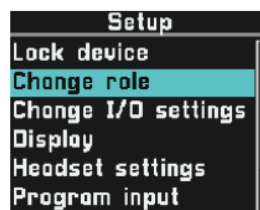

You may change your active Role. Roles can be defined with the help of Q-Tool configuration software.

### Change I/O settings

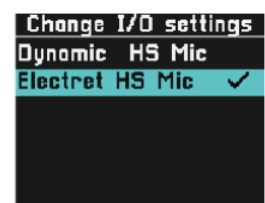
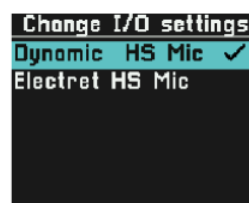
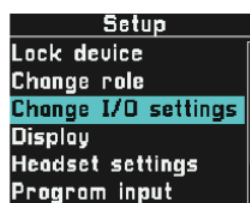

Select from different Headset settings presets. Q-Tool configuration software allows to define more I/O settings to match the specifics of the Headset of your choice.



## Display



## Brightness

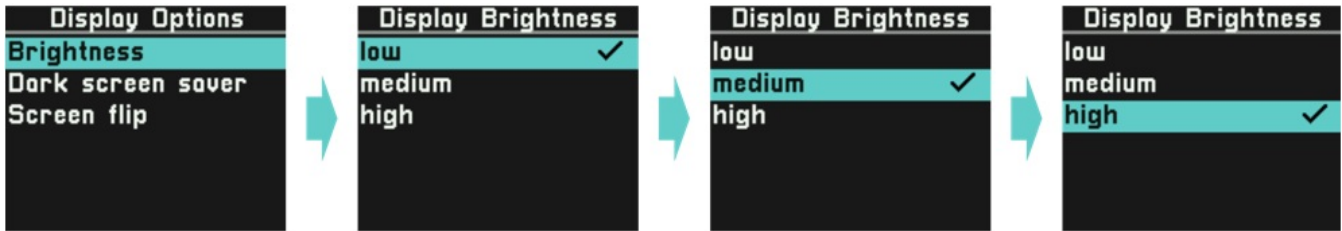

Brightness lets you control the backlight of the Display.

## Dark Screen Saver

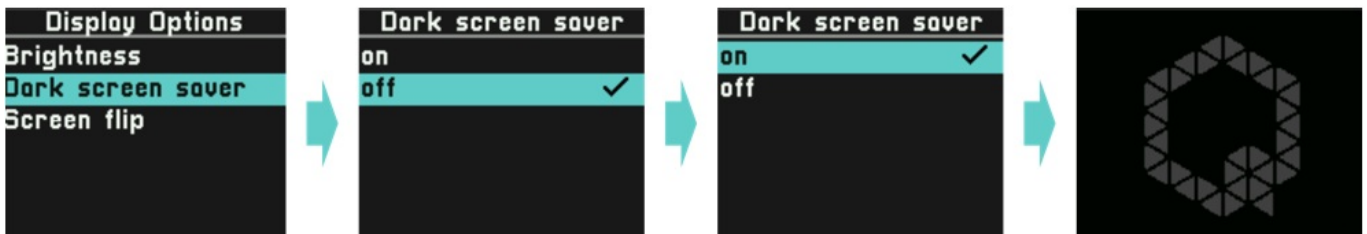

If the Dark Screen Saver is enabled, it will be activated automatically and deactivated by any button press or encoder turn. It will show a very low brightness Q logo when active.

## Screen Flip



The Screen Flip will turn your display upside down and flip the TALK and CALL control buttons to match. Use this setting when mounting your Beltpack in an upside down situation.

## Headset settings



Headset settings enable access to the settings predefined in the I/O settings. This gives you the option to fine-tune settings according to your specific situation. Your settings will be stored on the device and are applied again when you power up your device.

### Microphone Gain

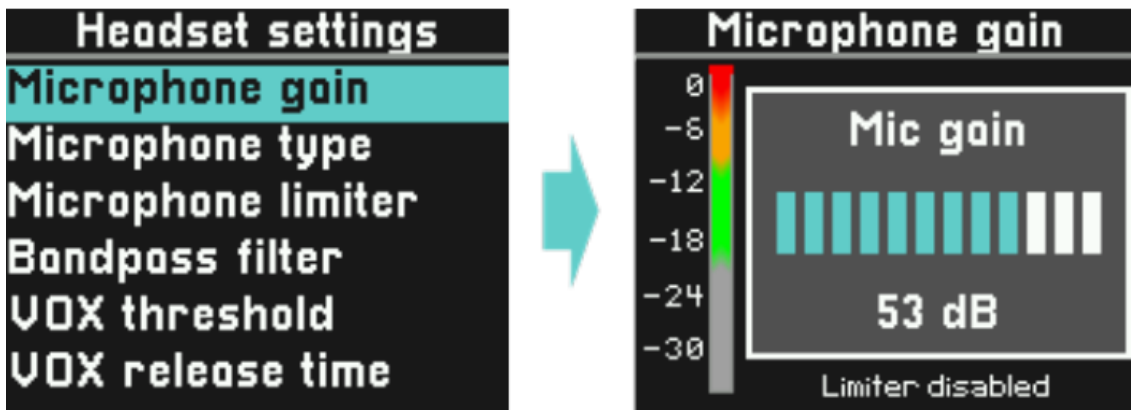

The gain of your microphone can be adjusted from 0 dB to 67 dB. Speak into your microphone at the volume you typically use when working and adjust the level to be in the upper green range. Please note that the limiter function is temporarily set to off when setting the gain level.

### Microphone Type

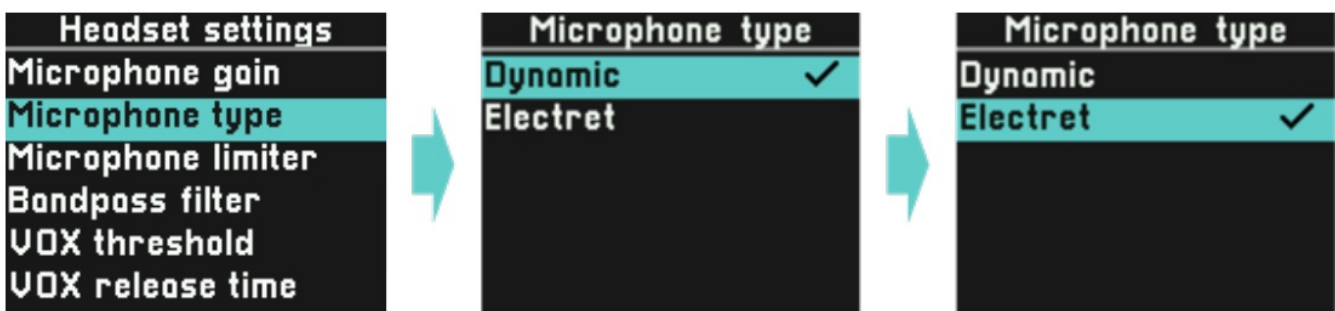

Electret microphones require a bias voltage for correct operation. If you set the microphone type to electret, a bias voltage will be applied to the microphone input. Dynamic microphones work without bias voltage.

### Microphone Limiter



The limiter function is used to avoid distorted signals if someone gets excited and starts to speak more loudly. We recommend to set the limiter to on.

### Band Pass Filter

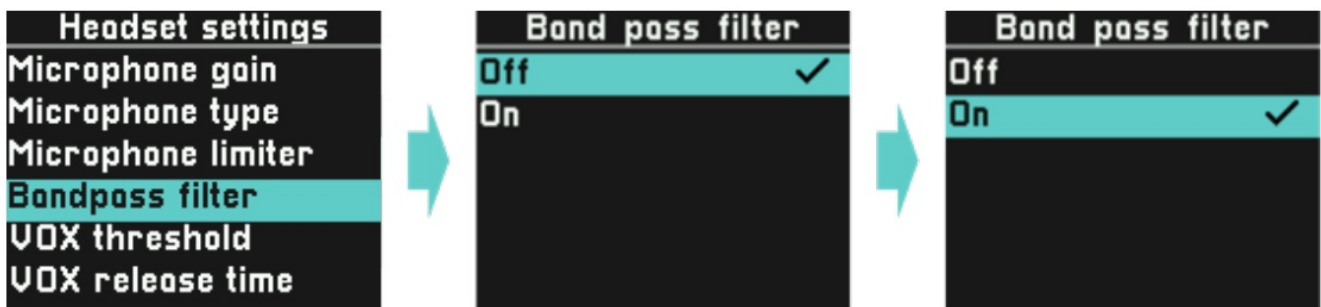

A Band Pass filter removes lower and higher frequencies from your microphone signal to improve speech intelligibility. Set to on if desired.

### Vox Threshold

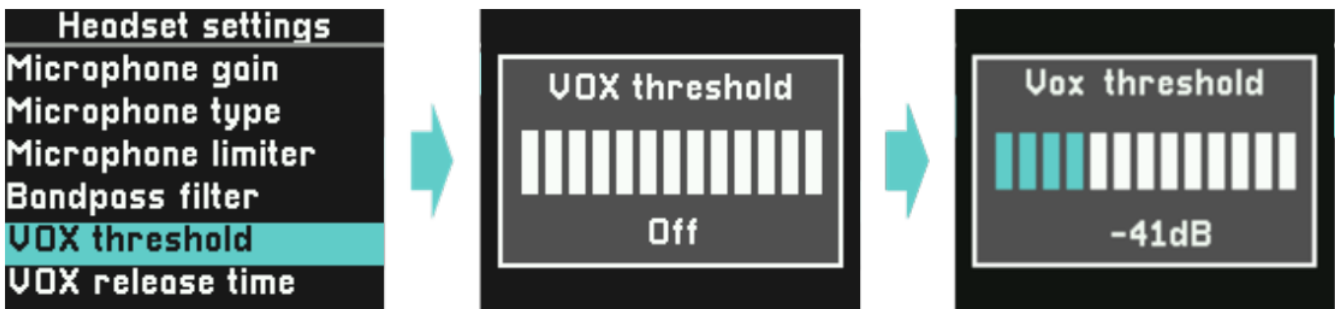

The Vox function acts as a signal gate and is used to reduce background noise in the system. The Vox threshold level determines at which level an audio signal is passed on to the system. Setting the Vox threshold to off completely removes the gate function from the signal path.

Make sure the level of your speech is higher than the VOX threshold level. Useable range is -64dB to -12dB

### Vox Release

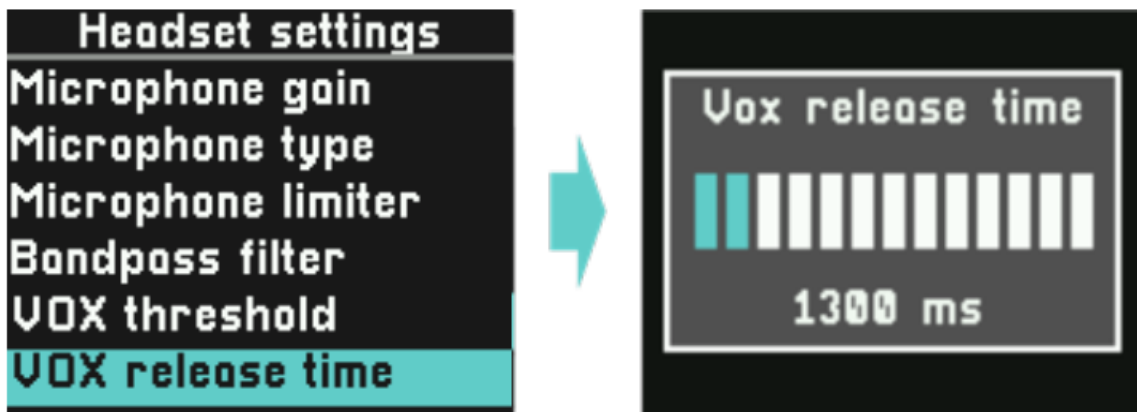

Vox release time determines how long your speech signal will be passed on to the system once the signal level goes below the VOX threshold level. This is used to avoid chopping your speech. VOX release time can be set from 500 milliseconds to 5 seconds in steps of 100 milliseconds.

### Program Input

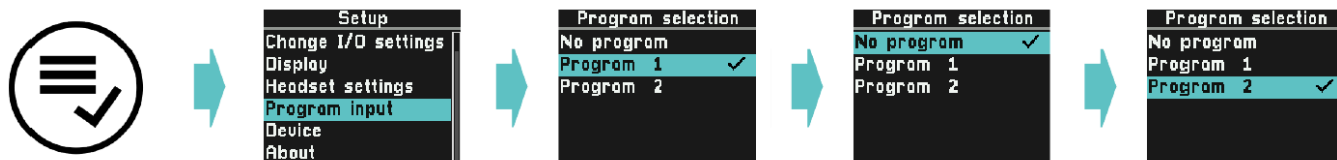

The Program Inputs defined for your partyline system are listed here. You may select the Program Input that best suits your Role. Selecting "No program" will switch off the Program input on your unit.

The program volume can be controlled using the volume button. See 0 

### Device



All current settings of your device are stored locally and applied again when powering up the device.

#### Reset Local Changes

With this choice you will revert all settings to the values as set in the active Role and I/O setting. Volumes will be set to the default values and the screen flip will be set to off.

#### Save personal settings

This will save your personal settings to a storage space on your unit that is NOT overwritten by a firmware or a system update.

#### Personal settings include:

##### Microphone settings:

- Microphone gain
- Microphone type
- Bandpass Filter
- VOX threshold
- VOX release time

### Volume settings:

- Master output
- Partyline fader left
- Partyline fader right
- Sidetone fader
- Program fader
- Buzzer fader

### Display settings:

- Brightness
- Screensaver
- Screen flipped

Settings previously will be overwritten.

### Load personal settings

This will restore your previously saved personal settings and apply them instantly.

### Factory reset

The unit will be reset to factory default settings.

Please note that your device will lose connection to your active partyline system unless it is the factory default system. Use Q-Tool to add a device to a system other than the factory default system.

### About



Get access to read only information about your device. Scroll to access all available information.

### Device Name

The default name of your device is derived from the unique MAC address of your device. Use Q-Tool to name the device differently. The given name will not be changed when applying a FW update. Resetting the device to factory default condition will also reset the device name.

### IP Address

This is the currently used IP address of the device.

### Firmware Version

This is the current firmware version. Use Q-Tool to retrieve and apply FW updates.

### Hardware Version

This is the hardware version of your unit. This value cannot be changed.

### MAC address

This is the MAC address of your device. This value cannot be changed.

### Q-Tool

Get your free copy of Q-Tool, the Q-series digital partyline configuration software to enjoy the full features of your punQtum intercom. You may download it from the punQtum website <https://punqtum.com/q-tool/>  
Please read the Q-Tool manual for more information on the configuration with Q-Tool.

## Connector Pinout

### Headset Connector

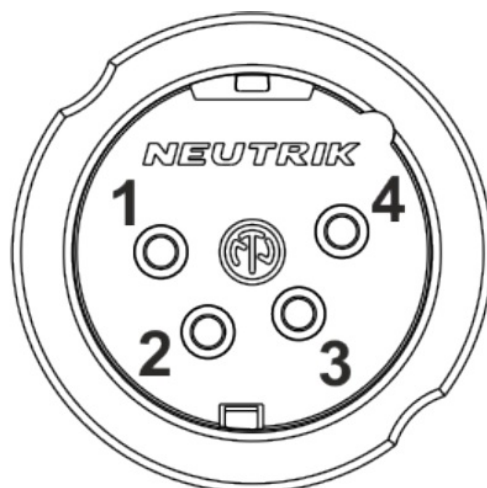

Figure 4

Pin	Description
1	Microphone –
2	Microphone + / +5V bias voltage for electret mic
3	Earphones –
4	Earphones +

The headset connector is a 4-pole male XLR connector and supports mono headsets with electret or dynamic microphones, depending on menu settings.

The microphone bias power (+5.8V) will be switched on/off according to the mic type setting. This can be changed directly in the Beltpack menu 6.5.2

### Network Connectors

PoE input & PoE output (pass through)

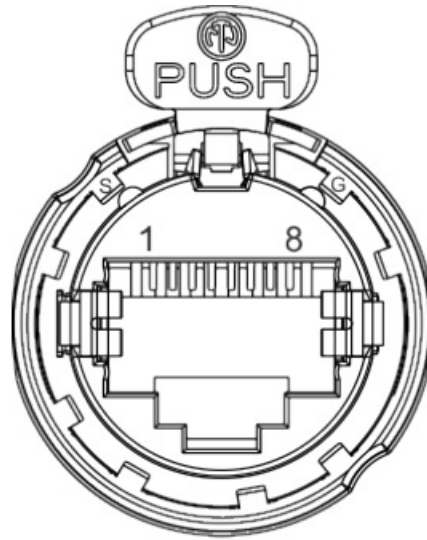

Pin	Description
1	TxRX A +
2	TxRX A –
3	TxRX B +
4	Input DC +
5	Input DC +
6	TxRX B –
7	Input DC –
8	Input DC –

### Technical specifications

Technical specifications are available in the Q110 Beltpack data sheet available from our website.

[WWW.PUNQTUM.COM](http://WWW.PUNQTUM.COM)

### Documents / Resources

	<p><a href="#">PUNQTUM Q-Series Network Based Intercom System</a> [pdf] User Manual  Q-Series, Q-Series Network Based Intercom System, Network Based Intercom System, Based Intercom System, Intercom System, System</p>
--	--

### References

- [Digital Intercom made affordable.](#)
- [User Manual](#)

[Manuals+](#), [Privacy Policy](#)

This website is an independent publication and is neither affiliated with nor endorsed by any of the trademark owners. The "Bluetooth®" word mark and logos are registered trademarks owned by Bluetooth SIG, Inc. The "Wi-Fi®" word mark and logos are registered trademarks owned by the Wi-Fi Alliance. Any use of these marks on this website does not imply any affiliation with or endorsement.