



ProtoArc XK01 Foldable Full Size Wireless Bluetooth Keyboard User Manual

[Home](#) » [ProtoArc](#) » ProtoArc XK01 Foldable Full Size Wireless Bluetooth Keyboard User Manual 

Contents

- [1 ProtoArc XK01 Foldable Full Size Wireless Bluetooth Keyboard](#)
- [2 Product Features](#)
- [3 Bluetooth Connection](#)
 - [3.1 Windows 10 System](#)
 - [3.2 Mac OS System](#)
 - [3.3 iOS System](#)
 - [3.4 Android System](#)
- [4 How to Switch Connection Mode](#)
- [5 Keyboard Charging](#)
- [6 Multimedia Function Keys](#)
- [7 Product Parameters](#)
- [8 Tips](#)
- [9 Sleep Mode](#)
- [10 Packing List](#)
- [11 Documents / Resources](#)
- [12 Related Posts](#)

ProtoArc 

ProtoArc XK01 Foldable Full Size Wireless Bluetooth Keyboard



Product Features

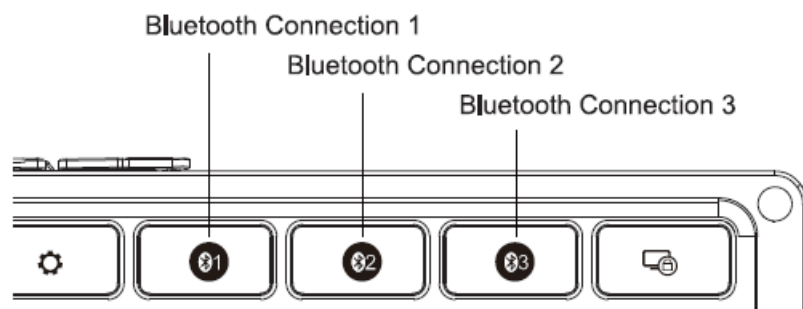
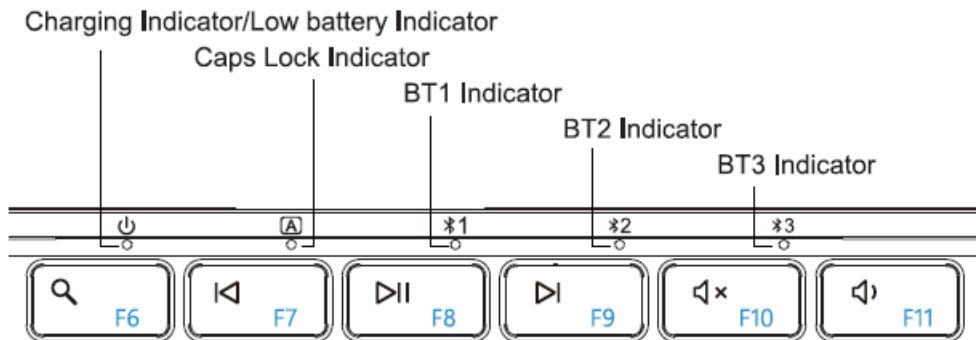
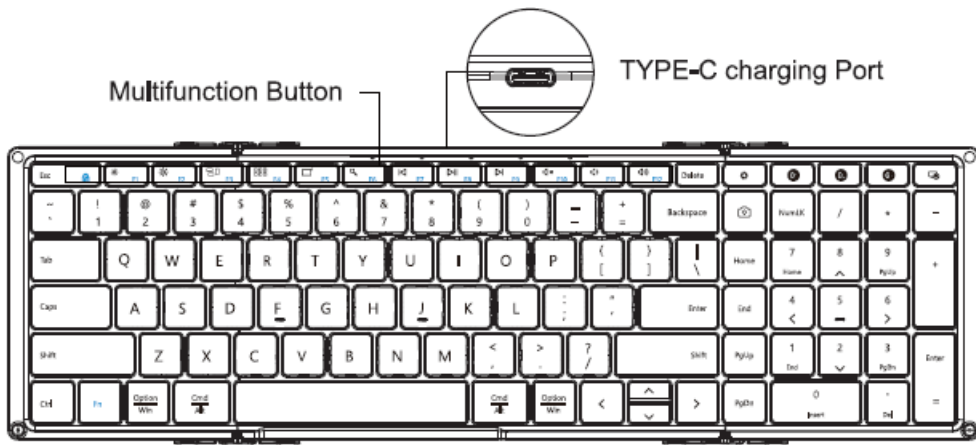

Bluetooth Connection

1. Unfold the Keyboard

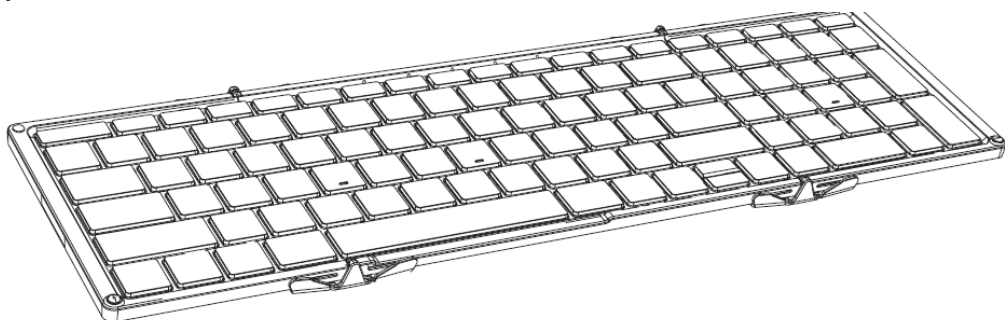

2. Single press to choose any Bluetooth connection the blue indicator light flashes once to enter Bluetooth mode. Then long press for 3-5s, when the blue indicator light flashing quickly, it enters Bluetooth pairing mode.

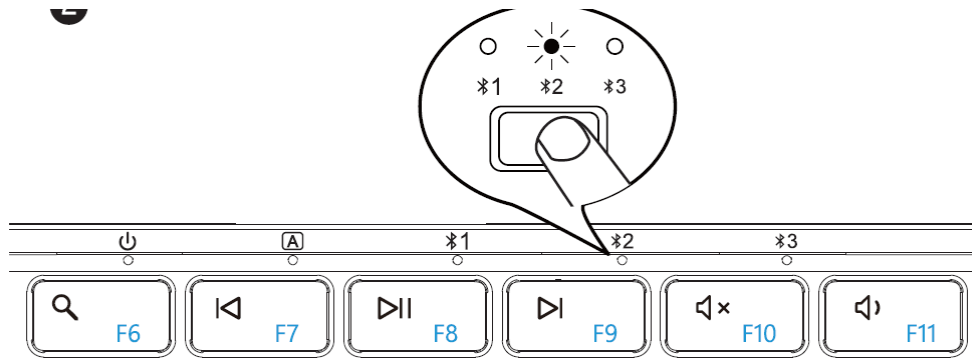

Windows 10 System

1. Click "Bluetooth Devices".

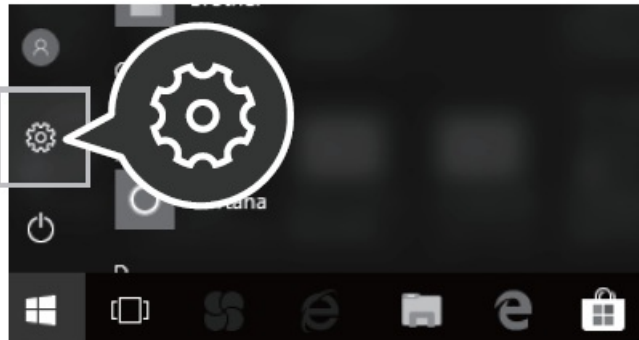

2. Click "Add or Remove Bluetooth Devices".

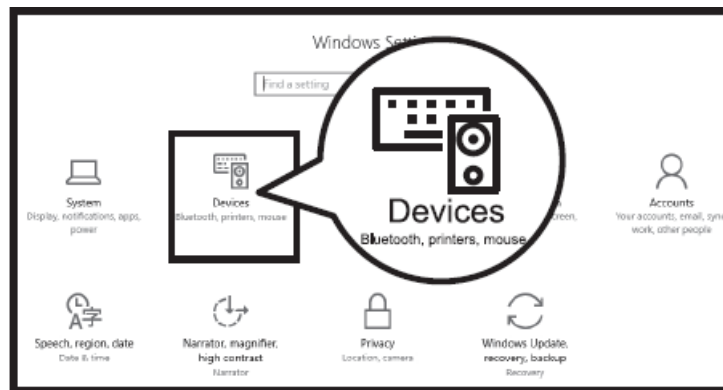

3. Your computer will automatically search for "ProtoArc XK01" and then click "pair".

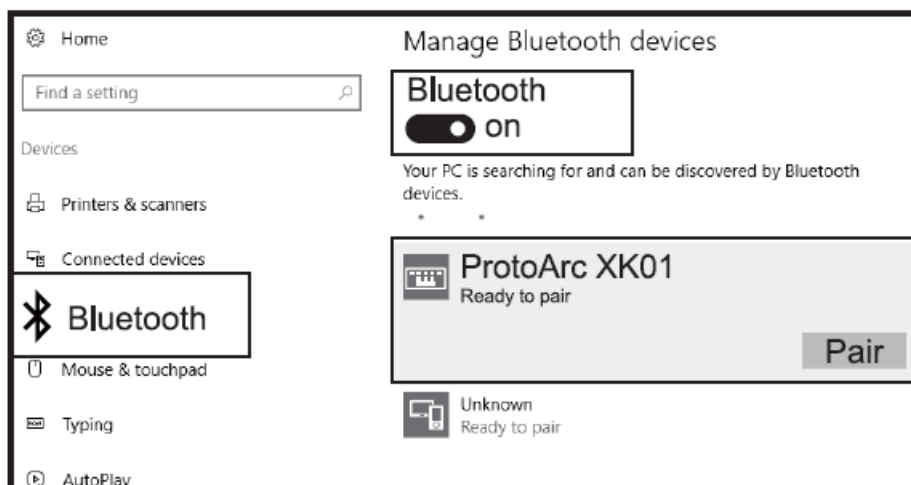

4. "ProtoArc XK01" is connected and it can be used normally.

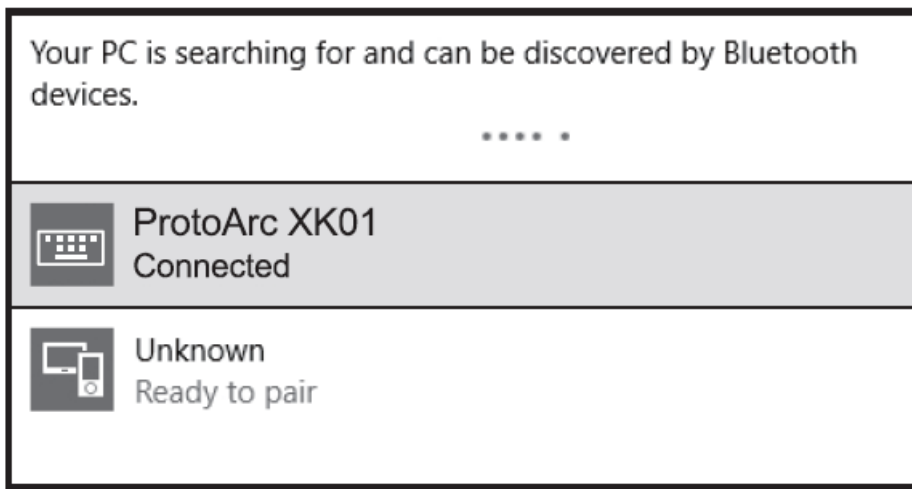

Mac OS System

Please complete the Bluetooth connection step before pairing.

1. Click "System Preferences" on Mac.



2. Click "Bluetooth" in "System Preferences".

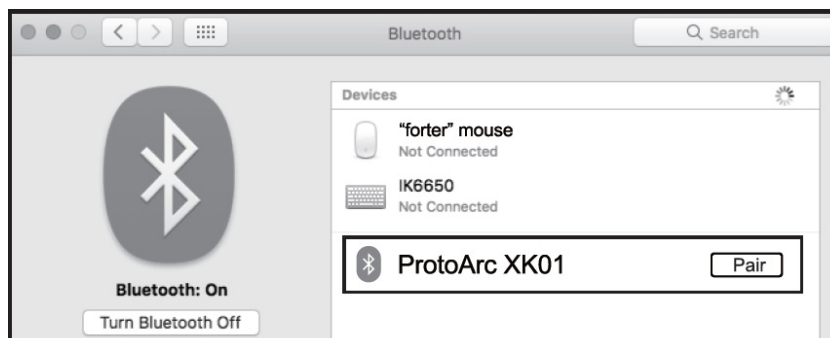

3. Your computer will automatically find "ProtoArc XK01", then click "pair", and you can use it after installation.

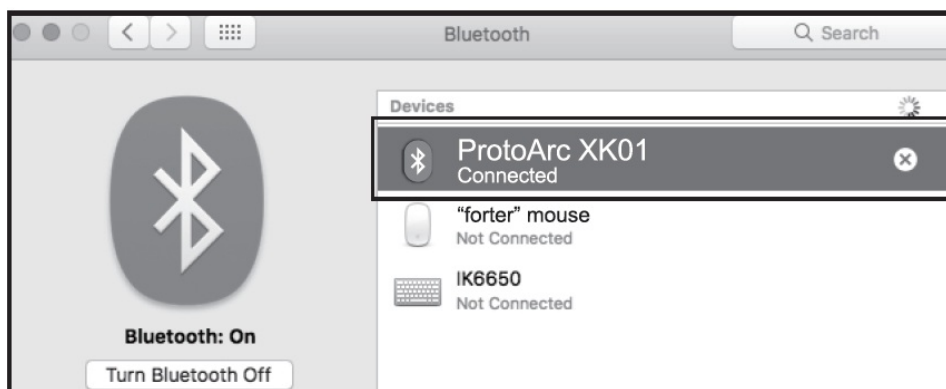

iOS System

Please complete the Bluetooth connection step before pairing.

1. Click "Setting" on the device and then turn ON the Bluetooth.

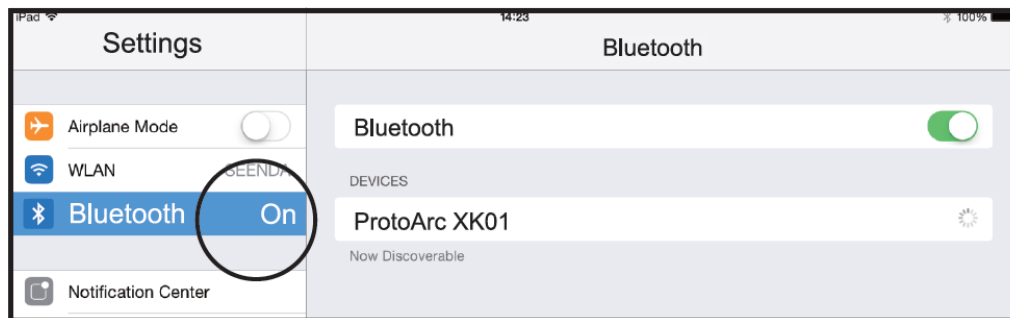

2. Your computer will automatically find "ProtoArc XK01", then click "pair", complete pairing.

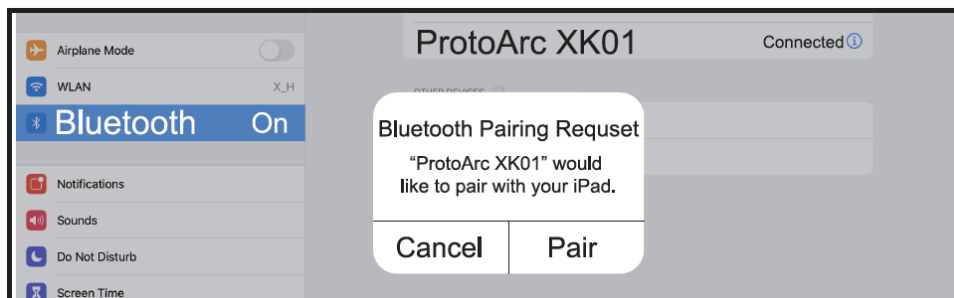

3. "ProtoArc XK01" is connected and it can be used normally.

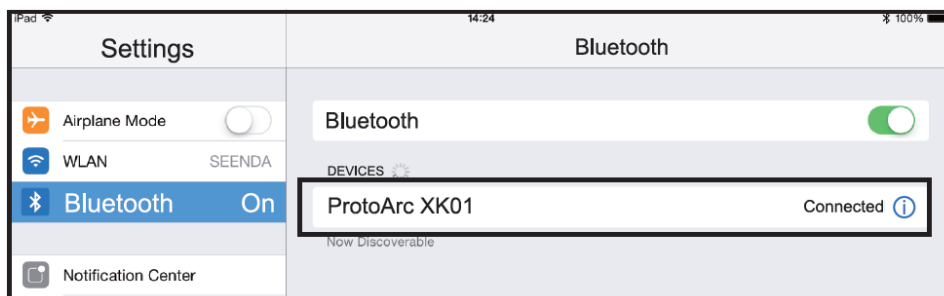

Android System

Please complete the Bluetooth connection step before pairing.

1. Click "Setting" on the device and then turn on Bluetooth.

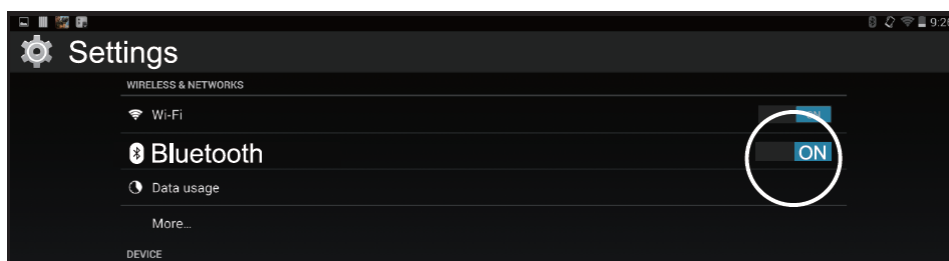

2. Your computer will automatically find "ProtoArc XK01", then click "pair", complete pairing.

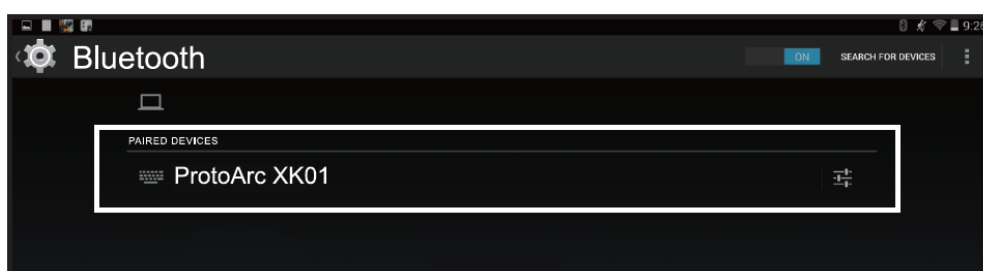

3. "ProtoArc XK01" is connected and it can be used normally.

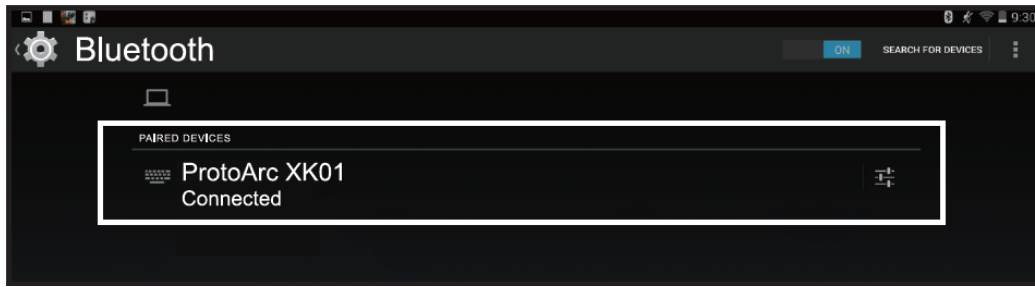

How to Switch Connection Mode

After connection, short press the keyboard connection button to easily switch to multiple devices.

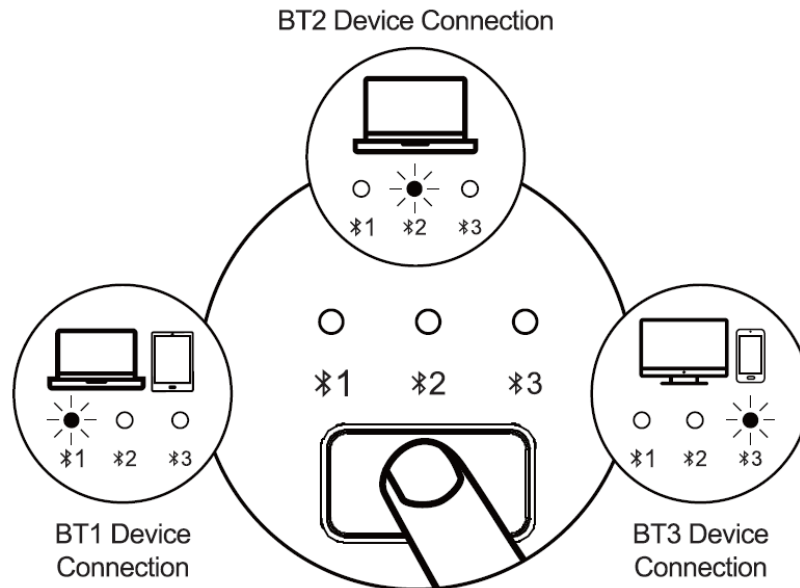

Keyboard Charging

When the battery is too low, the low battery indicator will turn red and flash quickly. Please connect to the power supply to charge in time to ensure that the keyboard has sufficient power to meet normal work.





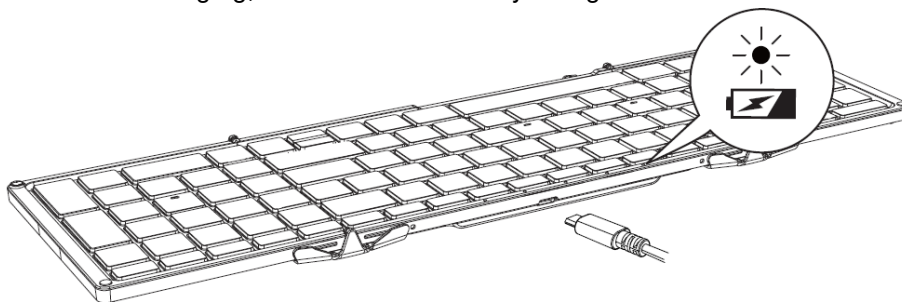











If the battery of the keyboard is too low, there will be delays and freezes and other problems in typing, which affect normal use.

Power indicator turns red while charging, then turn off after fully charged.



Multimedia Function Keys

Note: The FN function is a cyclic mode (F1-F12 and multimedia functions are cyclically used).

Keys	Windows OS	Android OS	iOS	Mac OS
	Light -	Light -	Light -	Light -
	Light +	Light +	Light +	Light +
	Window Switch	Window Switch	Window Switch	Window Switch
	Application Switch	Application Switch	Open latest Window	Open latest Window
	Display Desktop	Go Home	Go Home	Go Home
	Search	Search	Search	/
	Previous Track	Previous Track	Previous Track	Previous Track
	Play & Pause	Play & Pause	Play & Pause	Play & Pause
	Next Track	Next Track	Next Track	Next Track
	Mute	Mute	Mute	Mute
	Volume -	Volume -	Volume -	Volume -
	Volume +	Volume +	Volume +	Volume +
	Setup	Setup	Setup	Setup
	Lock Screen	Lock Screen	Lock Screen	/
	Screenshot	Screenshot	Screenshot	Screenshot
	FN+ESC (FN lock) button to turn on or turn off the FN function			

Product Parameters

- Battery Capacity: 21 0mAh
- Working Current: S3.5mA
- Sleep Current: 31 uA
- Charging Current: 190mA(±20mA)
- Standby Current: s0.3mA
- Standby Time: 150 Days
- Charging Time: <2 hours
- Wake Up Way: Press any key
- Keyboard Dimension: 386.4×119.7×12.4mm(Unfolded)
215.5×119.7×20.9mm(Folded)
- Weight: 297g

Tips

1. If it fails to connect normally, it is recommended to turn off the keyboard power, restart the Bluetooth of the device and connect again. Or delete the extra Bluetooth option name in the Bluetooth connection list of the

device and reconnect.

2. To switch to a channel that has been successfully connected, first press the channel button firstly, and then wait 3 seconds to keep working.
3. The keyboard mouse has memory function, when the keyboard mouse is connected properly at one channel, turn off the keyboard mouse and turn on again, the keyboard mouse will be in the default channel, and the indicator of this channel is on.

Sleep Mode

1. When the keyboard is not used for more than 30 minutes, it will automatically enter the sleep mode and the indicator light will be off.
2. When you use the keyboard again, you only need to press any key, and the keyboard will wake up within 3 seconds. The indicator will light up again and starts to work.

Packing List

- 1 Wireless Bluetooth Keyboard
- 1 Type-C Charging Cable
- 1 User Manual

Documents / Resources

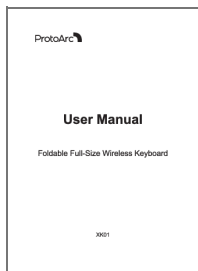
	<p>ProtoArc XK01 Foldable Full Size Wireless Bluetooth Keyboard [pdf] User Manual XK01 Foldable Full Size Wireless Bluetooth Keyboard, XK01, Full Size Wireless Bluetooth Keyboard, Bluetooth Keyboard</p>
---	--