

[Skip to content](#)

**[Manuals+](#)**

User Manuals Simplified.



# Paul Neuhaus 9708-13 Q-Amin Outdoor Lamp Instruction Manual

August 15, 2022 August 15, 2022 [Leave a comment on Paul Neuhaus 9708-13 Q-Amin Outdoor Lamp Instruction Manual](#)

[Home](#) » [Paul Neuhaus](#) » Paul Neuhaus 9708-13 Q-Amin Outdoor Lamp Instruction Manual 

Contents [hide](#)

[1 Paul Neuhaus 9708-13 Q-Amin Outdoor Lamp](#)

[2 SPECIFICATIONS](#)

[3 FEATURES](#)

[4 Fitting](#)

[5 Electrical connection](#)

[6 Teach remote control](#)

[7 Reset](#)

[8 Documents / Resources](#)

[8.1 Related Manuals / Resources](#)

*Paul Neuhaus*

Paul Neuhaus 9708-13 Q-Amin Outdoor Lamp



This product contains light sources of energy efficiency class.

## SPECIFICATIONS

230V/50Hz~

1x LED-Board 12V DC / 4,8W

1x LED-Board 12V DC / 6W

nicht wechselbar / not changeable

 2,4 GHz  
10 dBm

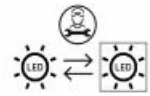
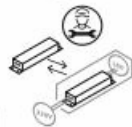

## FEATURES

 4,8 W / 6 W  
480 lm / 600 lm

 14 W  
540 lm

 LED-Board

**t** 25.000 h

**T<sub>k</sub>** 3.000 K / RGB

 15.000 x

 <0,5 s

 dimmable with rrc

## Fitting

as wall light

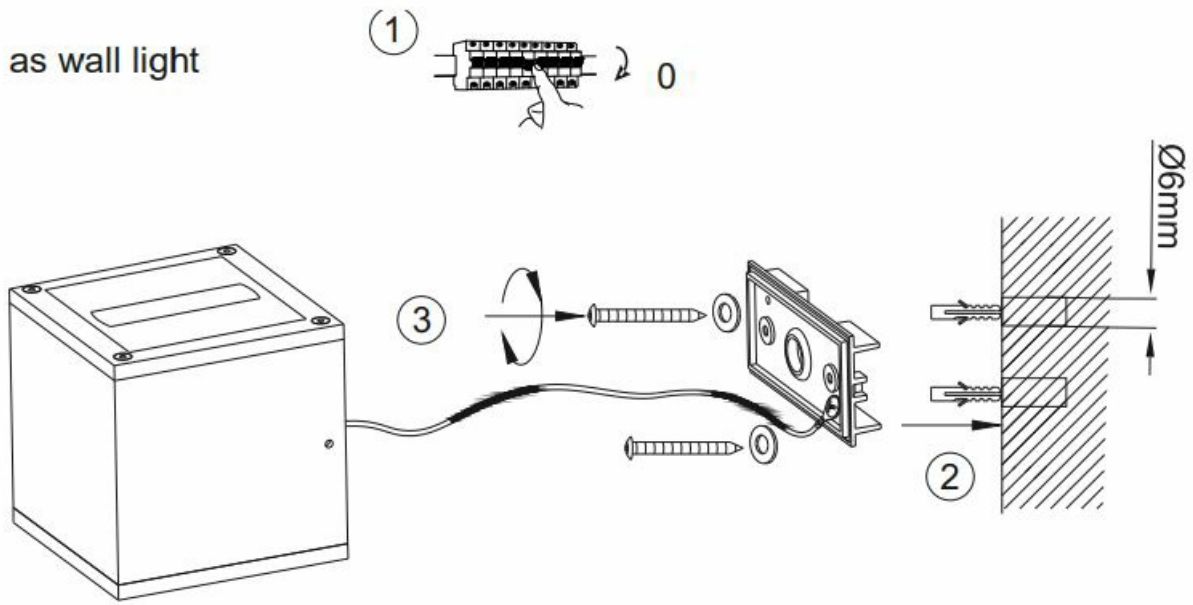

### Electrical connection

230 voltage/50 Hz connection

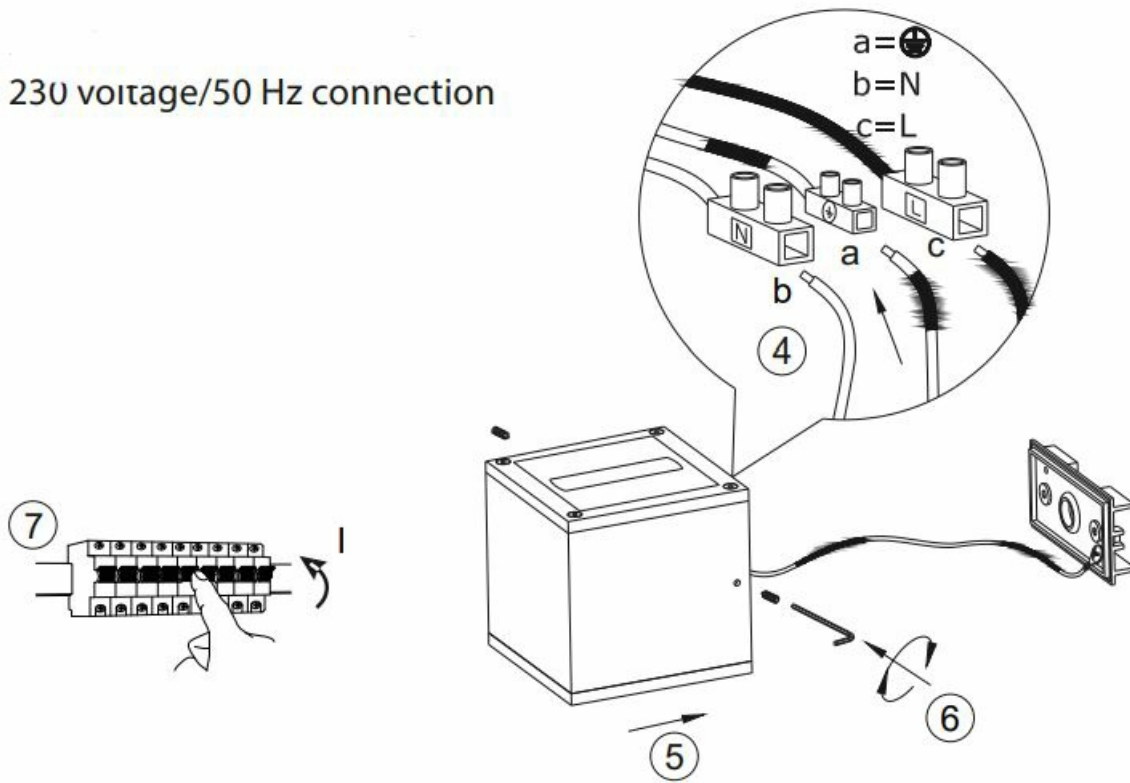

### Teach remote control

See Q-remote control manual

Q-Empfänger (Antenne)  
Q-receiver

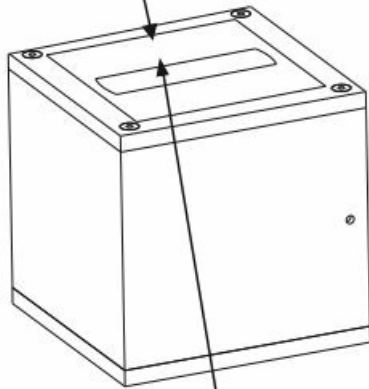

⑧ Leuchte einschalten  
Switch on the lamp



⑩ Q-Fernbedienung  
anlernen  
Teach Q-remote  
control



⑨ Bedienungsanleitung  
lesen  
Read instruction  
manual

## Reset

Reset the lamp, factory new

5 x on/off

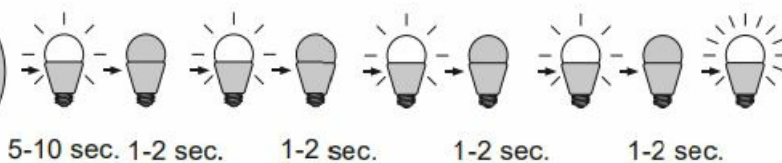

## Documents / Resources



[Paul Neuhaus 9708-13 Q-Amin Outdoor Lamp](#) [pdf] Instruction Manual  
9708-13, Q-Amin Outdoor Lamp, 9708-13 Q-Amin Outdoor Lamp, Outdoor Lamp, Lamp

## Related Manuals / Resources

[paul-neuhaus 831319 GEORG outdoor lamp User Manual](#)



paul-neuhaus 831319 GEORG outdoor lamp User Manual This product contains a light source of energy efficiency class <F>....

### [Paul Neuhaus LED table lamp User Guide](#)



Paul Neuhaus LED table lamp Operation Instructions This product contains a light source of energy efficiency class ....

### [Paul Neuhaus 997508 Standing Lamp Instruction Manual](#)



Paul Neuhaus 997508 Standing Lamp Features This product contains a light source of energy efficiency class What's In...

### [Paul Neuhaus 8410-13 40cm Q-VITO LED Pendant Lamp Instruction Manual](#)



Paul Neuhaus 8410-13 40cm Q-VITO LED Pendant Lamp SPECIFICATION IN THE BOX fitting electrical connection teach remote control...

#### Leave a comment

Your email address will not be published. Required fields are marked \*

Comment \*

Name

Email

Website

Save my name, email, and website in this browser for the next time I comment.

#### [Manuals+](#),

- [home](#)
- [privacy](#)