



# Oelo Evolution App User Manual

[Home](#) » [oelo](#) » Oelo Evolution App User Manual 📄

## Contents

- 1 Oelo Evolution App
- 2 GETTING STARTED
- 3 INITIAL SETUP:
  - 3.1 DOWNLOAD THE EVOLUTION APP
  - 3.2 CREATE YOUR ACCOUNT
  - 3.3 FIND YOUR CONTROLLER
  - 3.4 FIND YOUR CONTROLLER
  - 3.5 CONNECT TO YOUR WIFI
- 4 ZONE SETUP
  - 4.1 MORE ABOUT OELO “ZONES”
  - 4.2 ZONE SETUP
- 5 MAIN APP NAVIGATION
  - 5.1 YOUR ESSENTIAL CONTROLS
- 6 LIGHTING CONTROLS
- 7 MOVEMENT MODES
  - 7.1 MOVEMENT CUSTOMIZATION
- 8 PATTERNS
  - 8.1 PREMADE AND CUSTOM PATTERNS!
  - 8.2 USING OELO’S PRESET PATTERNS
  - 8.3 CREATING AND SAVING YOUR OWN CUSTOM PATTERNS
  - 8.4 USING THE SPOTLIGHT FEATURE
- 9 SCHEDULES
  - 9.1 SCHEDULING PATTERNS
- 10 SETUP TROUBLESHOOTING
- 11 Specifications
- 12 Frequently Asked Questions (FAQ)
  - 12.1 If I Can’t Connect to WiFi?
- 13 Documents / Resources
  - 13.1 References
- 14 Related Posts

## Oelo Evolution App



## USER MANUAL



### GETTING STARTED

Congratulations on the purchase of your new Oelo multi-color lighting system. This manual is for the setup and operation of the OELO LIGHTING SOLUTIONS EVOLUTION APP, which can be downloaded from the Apple App Store or Google Play Store.

### INITIAL SETUP:

#### DOWNLOAD THE EVOLUTION APP



Oelo Evolution   
Oelo LLC



**STEP 1:** Search "OELO," then download the **OELO EVOLUTION** App from the Apple App Store or Google Play Store. (Look for the light blue icon for our latest app version.)

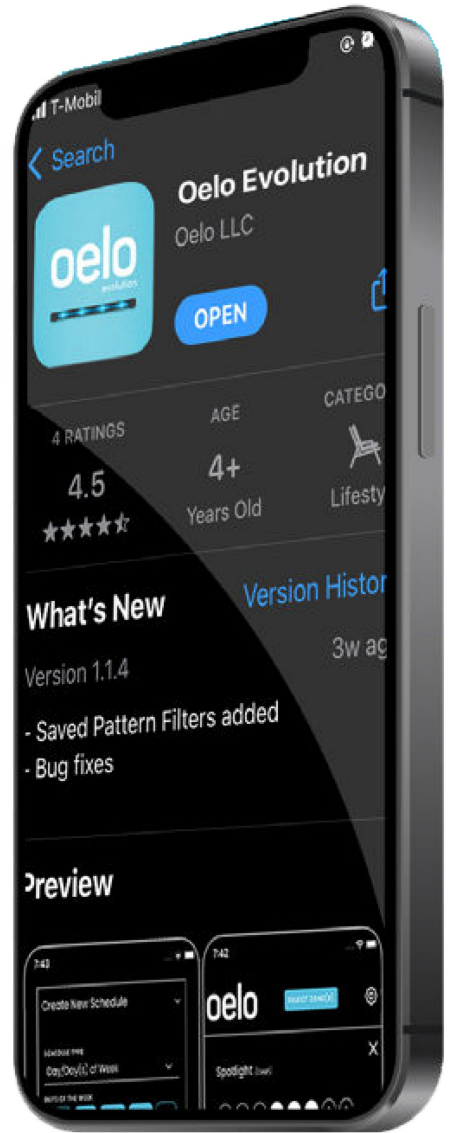

iPhone Screenshots

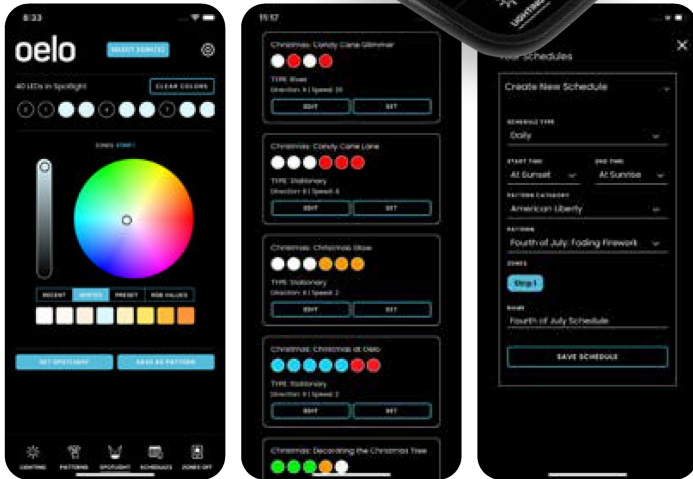

**CREATE YOUR ACCOUNT**

**STEP 2:** Plug in the Oelo controller box and wait for power to turn on.

### POWER / CONNECTION INDICATORS



**Red Light:** The Controller is receiving power.

**Blue Light Slow Flash:** The Controller is starting up, updating or attempting to connect.

**Blue Light Fast Flash:** The Controller is ready to connect to the App. Continue to Step 3.

**Blue Light:** The Control Box is connected (after Step 9 completion on the following pages).



**PRO TIP:** Oelo Dealers can connect via the Controller AP, if they want to test the lights without an account.

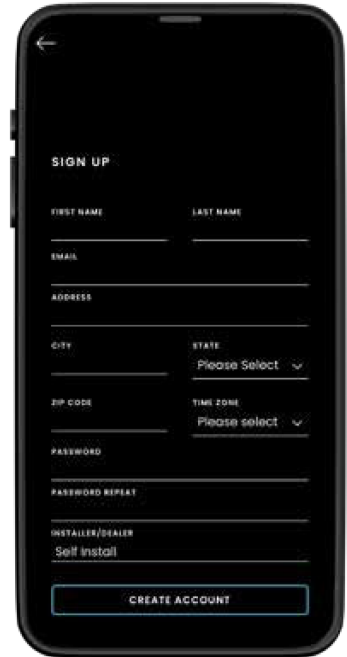

**STEP 3:** Open the Oelo Evolution App. If this is your first time signing in, please create an account. >

(If you are an existing Oelo customer, who purchased a controller retrofit, you also will need to create a new Oelo Evolution account.)

**STEP 4:** To create your account, tap "Don't have an account?" and complete the Sign Up form.

CONTINUE

CONTROLLER SETUP

### FIND YOUR CONTROLLER



**STEP 5:** Select **FIND MY CONTROLLER**.



**STEP 6:** Wait for the App to find the Controller. Stand close to the Controller for the fastest results.

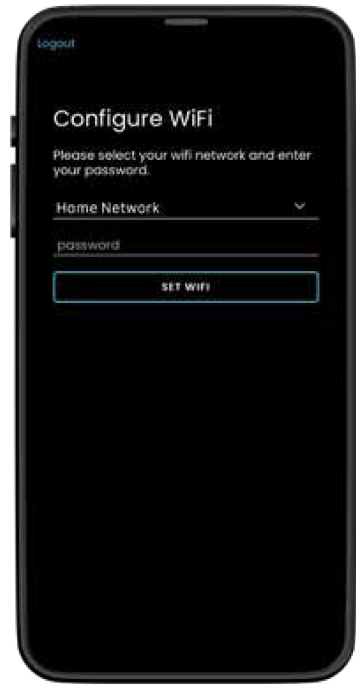

**STEP 7:** Select your WiFi network from the dropdown menu and enter your network password.

## STEP 1: CHECK THE CONTROLLER INDICATOR LIGHTS

**Red Light:** The Controller is receiving power. (If this light is not illuminated, check that 1) a breaker hasn't been tripped, 2) the box is plugged in and 3) the Power Switch is flipped in the ON position (toward the orange connectors).

If the Red Light is off and the above steps don't help, "re-boot" your box by unplugging and plugging it back in, then watch for the Blue Light to run through this series ...

**Blue Light Slow Flash:** The Controller is starting up, updating or attempting to connect.

**Blue Light Fast Flash:** The Controller is ready to connect to the App. Return to Step 5. (The Blue Light will stop flashing and glow solid once Steps 5-8 are completed successfully.)

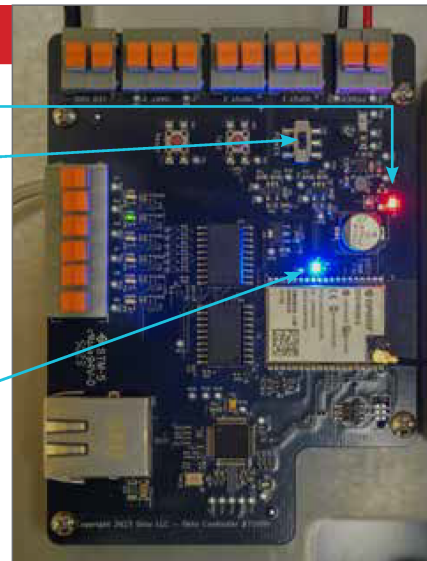

oelo.com

## FIND YOUR CONTROLLER

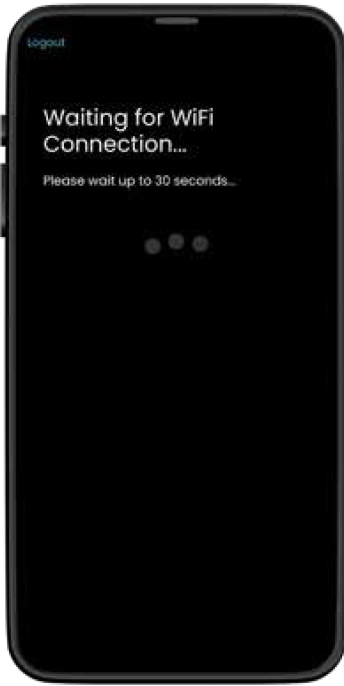

**STEP 8:** Wait for WiFi connection.



**STEP 9:** Enter a name for your controller, like "Home."



**IF YOU CAN'T CONNECT:**

**STEP 2: CHECK CONTROL BOX ANTENNA**

If re-powering the Control Box does not work, check the Control Box Antenna. **Disconnect the power first before touching the antenna!** Ensure the antenna is connected to the Controller by firmly pressing down on the antenna attachment, then run through the initial setup instructions.

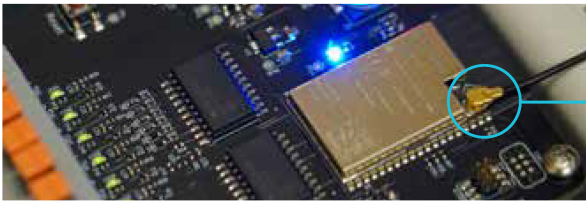

**STEP 3: CHECK NETWORK RANGE**

Make sure the Controller is within range of your WiFi network and confirm your network is working properly.



**CONNECT TO YOUR WIFI**

## WHAT ARE ZONES?

Zones are separate light strand outputs that you can control independently from one another, allowing you to run different colors, movements and patterns from each zone. Each Oelo Controller can support up to six Zones. Before installation, your installer would have determined how best to illuminate your structure(s) and if zones were needed.

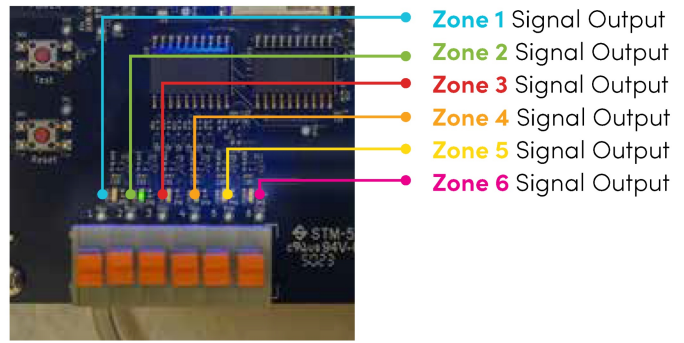

Zone Outputs

## BELOW IS AN EXAMPLE OF HOW ZONES CAN BE UTILIZED:

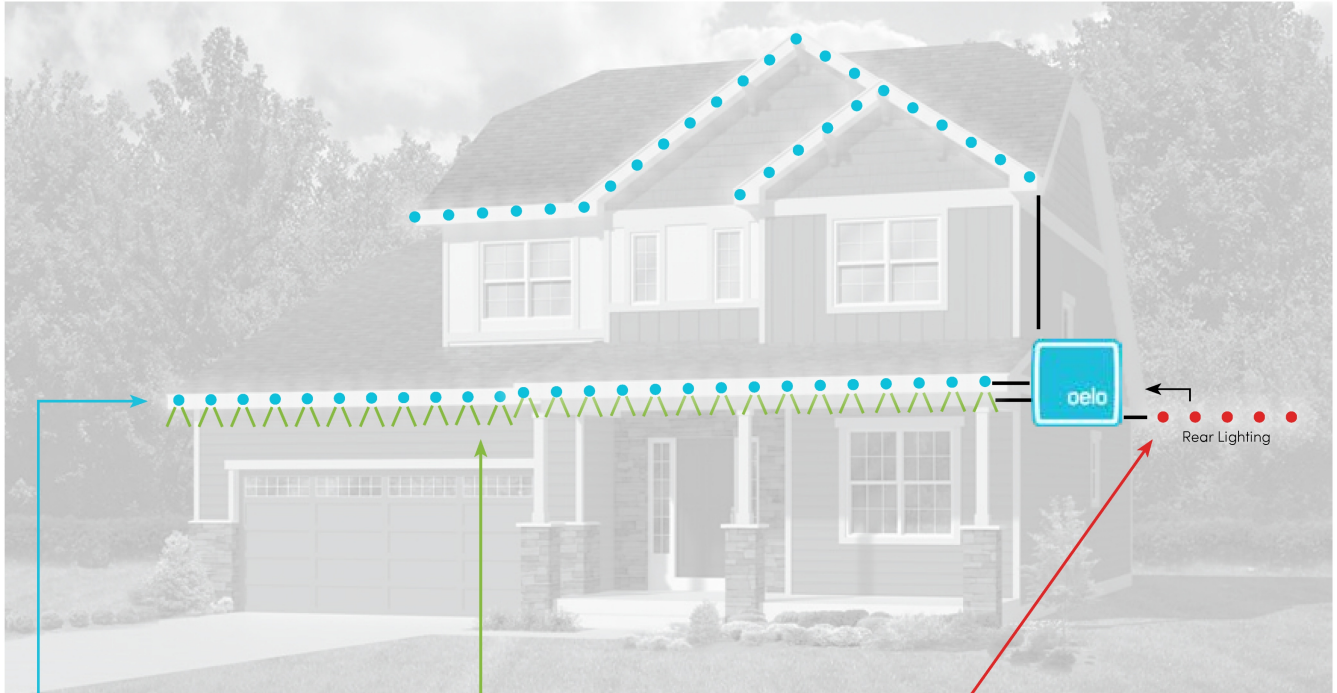

**ZONE 1:** The first Zone runs across the first- and second-floor facade, facing **OUTWARD**, to create traditional lighting.

**ZONE 2:** The second Zone is hung **DOWNWARD** to create a wall-wash effect, as well as security/spotlighting.

**ZONE 3:** A third Zone is installed on the **REAR** of the home for its own separate backyard/patio lighting.

## ZONE SETUP

Oelo's state-of-the-art controller touts **SIX INDIVIDUALLY ADDRESSABLE OUTPUTS**, which allows you to control more than half a dozen zones separately from one controller for creative, hybrid installs and out-and-down lighting effects!

## MORE ABOUT OELO "ZONES"

**STEP 10:** Configure your Zones.

Tap **✓** to select which Controller you are configuring. (Customers with large properties or multiple buildings may have multiple controllers. The Oelo Evolution App allows users to operate any controller from one login.)

Select **YES** or **NO** to enable or disable Zone Outputs. (Zones are enabled by default.)

Tap **NAME** to change the name of the selected Zone. (Example Names: Front Out, Front Down, Rear Patio.)

Input how many **LEDS** that Zone contains.

Select your **MIRROR ZONE** settings:

- The **Independent** selection allows the Zone to function separately.
- The **Mirror** selection lets you choose another Zone that you would like to mirror.

Tap **>** or **1, 2, 3, 4, 5, 6** to switch to a different Zone.

Click **UPDATE CONTROLLER** to save your Zone changes.

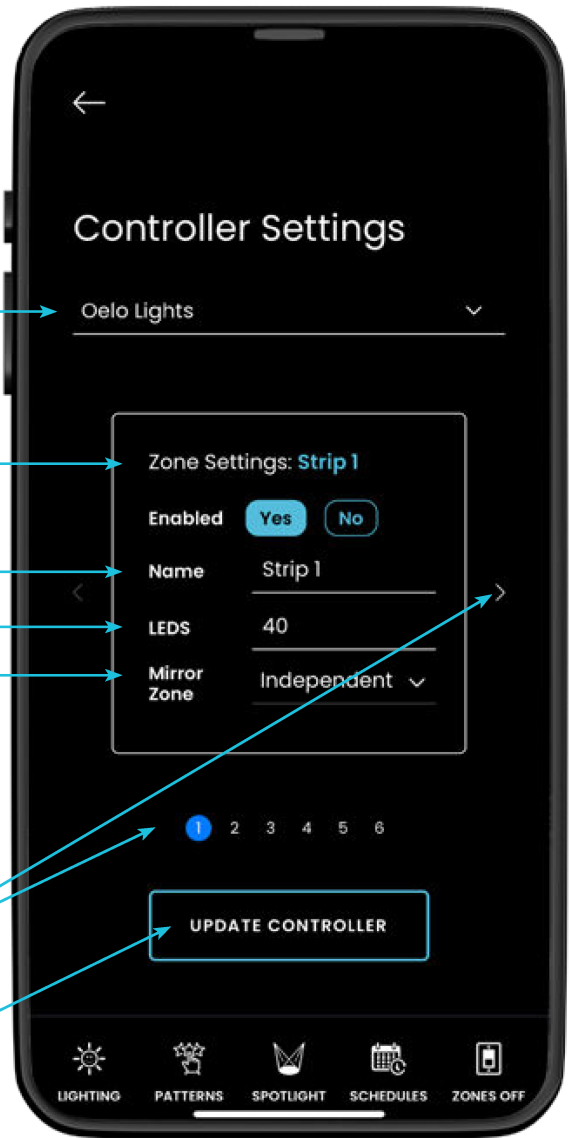

oelo Light Count		
Zone	Location	#LEDS
1	_____	_____
2	_____	_____
3	_____	_____
4	_____	_____
5	_____	_____
6	_____	_____

**TIP!** Use the supplied label to document your zones and apply this sticker inside your control box.

**ZONE SETUP**



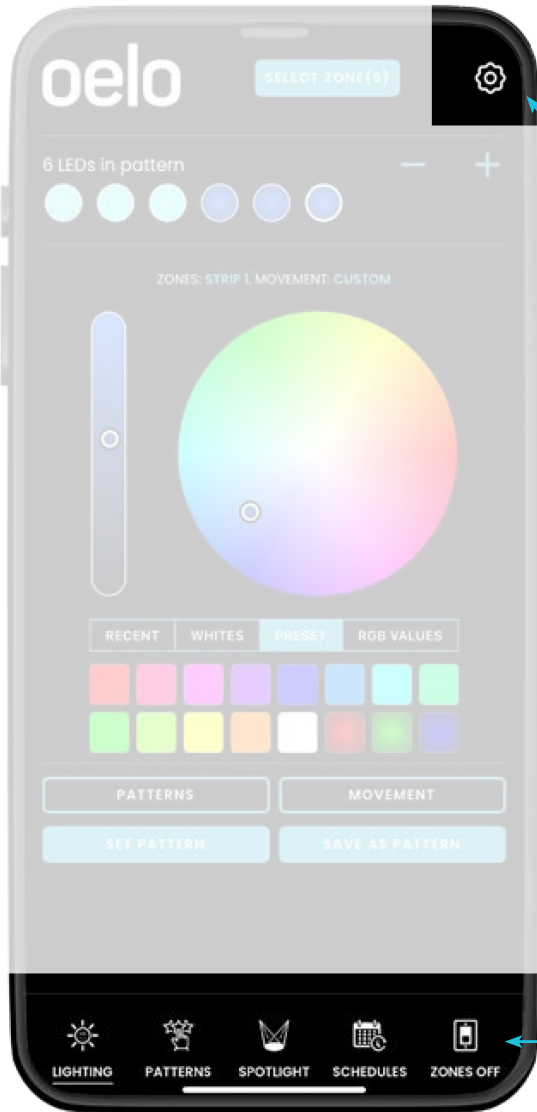

## MAIN APP NAVIGATION

The Oelo Evolution App offers these essential controls:



Select the **GEAR** icon for **account settings**.



Use the **LIGHTING** controls to **customize your LEDs** colors, pattern, movement and LED count. **PAGE 10**



Tap **PATTERNS** to choose a light sequence from your **custom patterns** or **Oelo pre-set patterns**. **PAGE 12**



Add **security lighting** or **highlight structural features** with Oelo's **SPOTLIGHT** feature. **PAGE 13**



**Schedule your lighting patterns** in advance with Oelo's **SCHEDULES** option. **PAGE 14**



Tap **ZONES OFF** to **turn lights off** manually.

## MAIN APP NAVIGATION

### YOUR ESSENTIAL CONTROLS

Select the **GEAR** icon for these **account settings**.

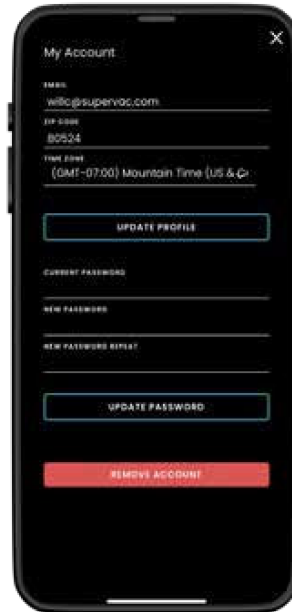
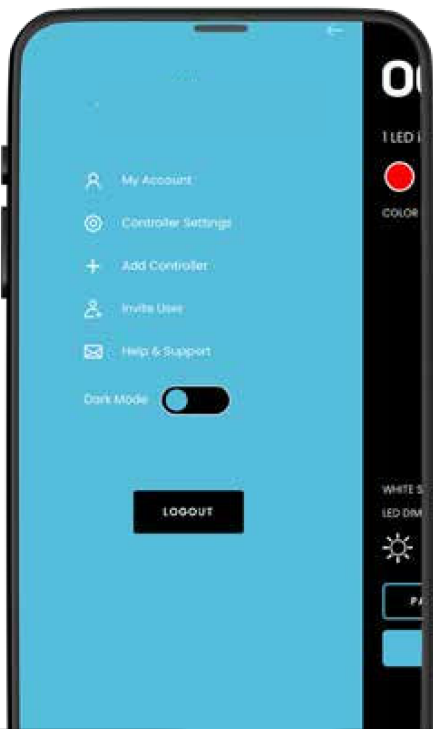

**MY ACCOUNT:** Update your email, time zones and passwords here.



**CONTROLLER SETTINGS:** Modify Controller Zone settings here. **PAGE 6-7**



**ADD CONTROLLER:** Need to add more Controllers? Tap Add Controller, then see **Page 4** instructions.

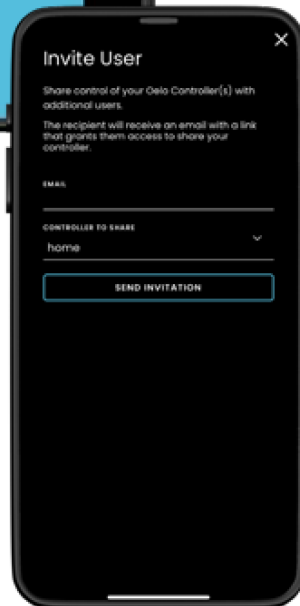

**INVITE USERS:** Share control of your Oelo Controller(s) with others.



**DARK/LIGHT MODE:** Adjust your app's Dark / Light display preferences.



## LIGHTING CONTROLS

## LIGHTING CONTROLS

Upon launching your App, you can customize your lights colors, pattern, movement and LED count on the **LIGHTING** screen using these controls:

- 1 Tap **SELECT ZONE(S)** to **customize one or more zones**. The selected Zone(s) will be shown above the color wheel.
- 2 Hit the **+** button to add the **number of LEDs** in a pattern, then tap the **LED CIRCLE** to **customize the LED**. Select the **-** button and tap one of the LEDs in the pattern to delete.
- 3 Slide the **MARKER** around to **change the hue**.
- 4 Raise and lower the **DIMMER** to adjust **color brightness**.
- 5 Tap **RECENT** to choose **past colors** for easy re-selection.
- 6 Select **WHITES** to quickly choose a **white hue**.
- 7 Choose **PRESET** for a **selection of standard vibrant colors**.
- 8 Tap **RGB VALUES** to **adjust colors precisely**.
- 9 Tap **PATTERNS** to choose a lighting sequence from your favorite **custom patterns** or an **Oelo pre-set pattern**.
- 10 Tap **MOVEMENT** to modify your pattern's **movement**.
- 11 Select **SET PATTERN** to **display your lighting sequence**.
- 12 Tap **SAVE AS PATTERN** to **save your lighting sequence**.

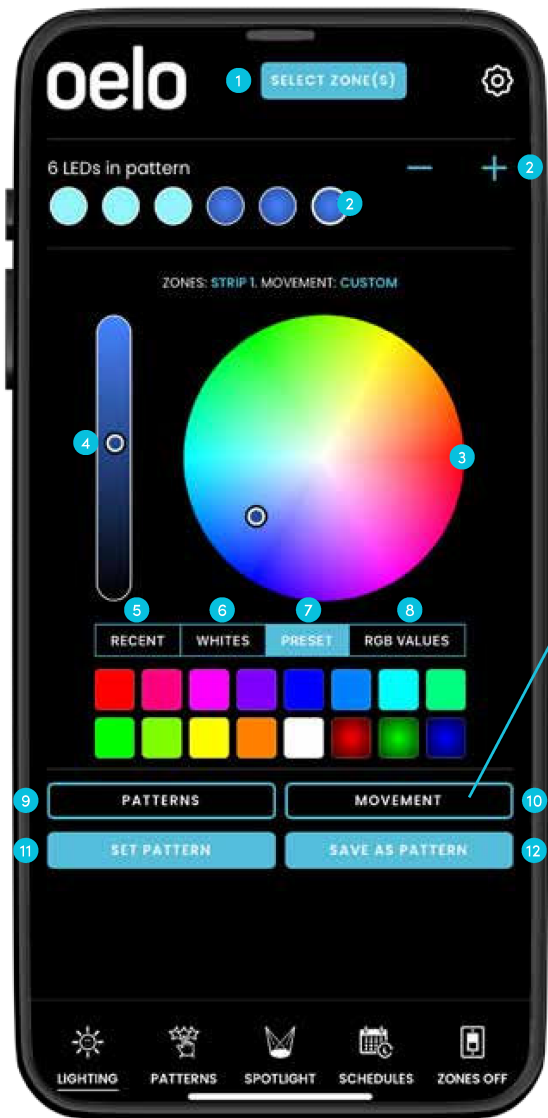

## MOVEMENT MODES

### MOVEMENT CUSTOMIZATION

# MOVEMENT MODES

## OPERATING YOUR LIGHTS: MOVEMENT CUSTOMIZATION



### MOVEMENT MODE

The Evolution App offers a variety of **MOVEMENT MODES** that lets you customize how the lights move, fade and pulse. You can even change the speed and gaps in the movement mode to further customize your lights. Tap the **MOVEMENT** button on the **LIGHTING SCREEN** to view all of the movement modes. Select a mode, modify and then save.



#### STATIONARY

Choose this mode for an iconic Christmas look.

#### ARCADE

Let a hue fill in the strand, gradually slowing.

#### BLEND

Blend two colors for a gradient effect.

#### BOLT

Shoot a color through the strand for a bolt effect.

#### CHASE

Pick two colors (or more) to chase each other.

#### FILL

Create a fill effect with this in-ward movement.

#### MARCH

March your favorite repeated hues.

#### LIGHTNING

Add an extra jolt to your stagnant colors!

#### RIVER

Blend transitioning hues for a flowing effect.

#### SHUFFLE

Shuffle one hue for another for a fun effect.

#### SPLIT

Evenly split two colors for a dual-lighting result.

#### SPRINKLE

Slightly fade each LED for a sprinkling illusion.

#### STORM

Flash random lightning across blended colors.

#### STREAK

Control speed and gaps to create a streak effect.

#### TWINKLE

Drastically fade each LED for a twinkle effect.

#### TAKEOVER

Take over your marching pattern with the last hue.

PLUS, SPOTLIGHT ENTRYWAYS, WALKWAYS AND MORE! Turn on (and off) select LEDs for security lighting. **PAGE 13**



STATIONARY



STREAK



SPLIT

## PATTERNS

PREMADE AND CUSTOM PATTERNS!



### PRE-MADE AND CUSTOM PATTERNS!

The Evolution App offers more than 55+ pre-made patterns to celebrate most any favorite occasion! You can find these patterns by selecting the **PATTERNS** icon in the App's main footer navigation or by tapping the **PATTERNS** on the LIGHTING screen. You also can create, save and re-use your own custom patterns! (Look for  under on the Patterns page.)



### WANT TO SHARE YOUR CUSTOM PATTERNS?

Create and save your own custom patterns using the instructions on Page 13. Then, **CLICK THE SHARE ICON.**

1. Choose how you would like to share the pattern with a friend (ie. text, email, social media, etc.)
2. Your friend will receive a link to input their Oelo credentials. Wah lah! Your pattern will be shared to "Your PATTERNS." If you do not see the shared pattern, close and re-open the app to refresh your system.



### USING OELO'S PRESET PATTERNS



### PRE-MADE AND CUSTOM PATTERNS!

The Evolution App offers more than 55+ pre-made patterns to celebrate most any favorite occasion! You can find these patterns by selecting the **PATTERNS** icon in the App's main footer navigation or by tapping the **PATTERNS** on the LIGHTING screen. You also can create, save and re-use your own custom patterns! (Look for  under on the Patterns page.)



### WANT TO SHARE YOUR CUSTOM PATTERNS?

Create and save your own custom patterns using the instructions on Page 13. Then, **CLICK THE SHARE ICON.**

1. Choose how you would like to share the pattern with a friend (ie. text, email, social media, etc.)
2. Your friend will receive a link to input their Oelo credentials. Wah lah! Your pattern will be shared to "Your PATTERNS." If you do not see the shared pattern, close and re-open the app to refresh your system.



### CREATING AND SAVING YOUR OWN CUSTOM PATTERNS



**STEP 1:** Add LEDs (+ and -) to the pattern and select your **COLORS** with the LIGHTING screen's various color tools.



**STEP 2:** Tap the LIGHTING screen's **MOVEMENT** button to select, modify and save your Movement Mode settings.



**STEP 3:** Upon saving, you will return to the LIGHTING screen. Tap the **SET PATTERN** button to display your sequence.

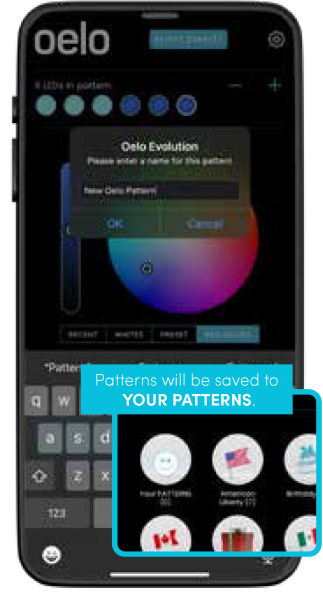

**STEP 4:** Tap the LIGHTING screen's **SAVE AS PATTERN** button to save and name the sequence. Your pattern will be saved under Patterns > Your PATTERNS.

## USING THE SPOTLIGHT FEATURE

### SPOTLIGHT ENTRYWAYS, WALKWAYS AND MORE!

Turn on (and off) select LEDs for security lighting.  
**STEP 1:** To spotlight your building, tap the **SPOTLIGHT** icon in the main navigation.



**STEP 2:** Select your spotlight **COLOR** using the color wheel, white pre-sets or other color selector tools.



**STEP 3: TAP THE LEDs** in the light strand that you want to illuminate.  
 (The LEDs will change to the selected hue. Slide the LEDs side to side to view all of the LEDs in your strand.)

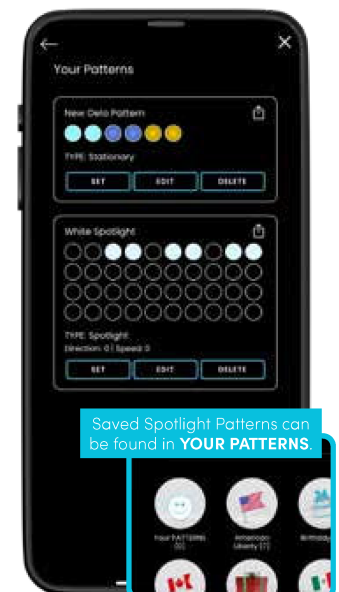

**STEP 4:** Tap **SET SPOTLIGHT** to display your selections, and push **SAVE AS PATTERN** to create a re-usable pattern (saved in YOUR PATTERNS).

## SCHEDULES

The SCHEDULES calendar icon at the bottom of your phone is used to create a lighting schedule. Use this feature to schedule out daily, weekly or yearly use.

### SCHEDULING PATTERNS

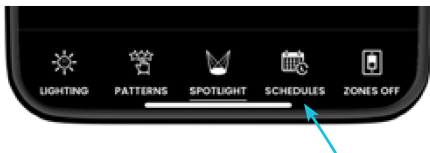

**STEP 1:** Tap **SCHEDULES** in the main navigation.

**STEP 2:** Select **CREATE NEW SCHEDULE**, then ...

- 1 Choose **SCHEDULE TYPE** to change the schedule repetition:

**Daily:** Displays every day.

**Day/Day(s) of Week (Repeats Weekly):**

Choose which days of the week that you would like to repeat your pattern on a weekly basis.

**On Date(s) (Repeats Yearly):**

Select start and end date; repeats every year.

**On Date(s) (One Time):** Choose start and end date; does not repeat.

- 2 Select **START TIME** and **END TIME** to change what time the pattern begins and ends, either **At Set Time**, **At Sunset** or **At Sunrise**.
- 3 Tap **PATTERN CATEGORY/PATTERN** to choose which category and pattern to schedule, choosing from **My Patterns** (your saved custom light patterns) or **Pre-Set Patterns** (Oelo's patterns).
- 4 Enable which **ZONES** are controlled by the schedule.
- 5 **NAME** your schedule.
- 6 **SAVE SCHEDULE**.

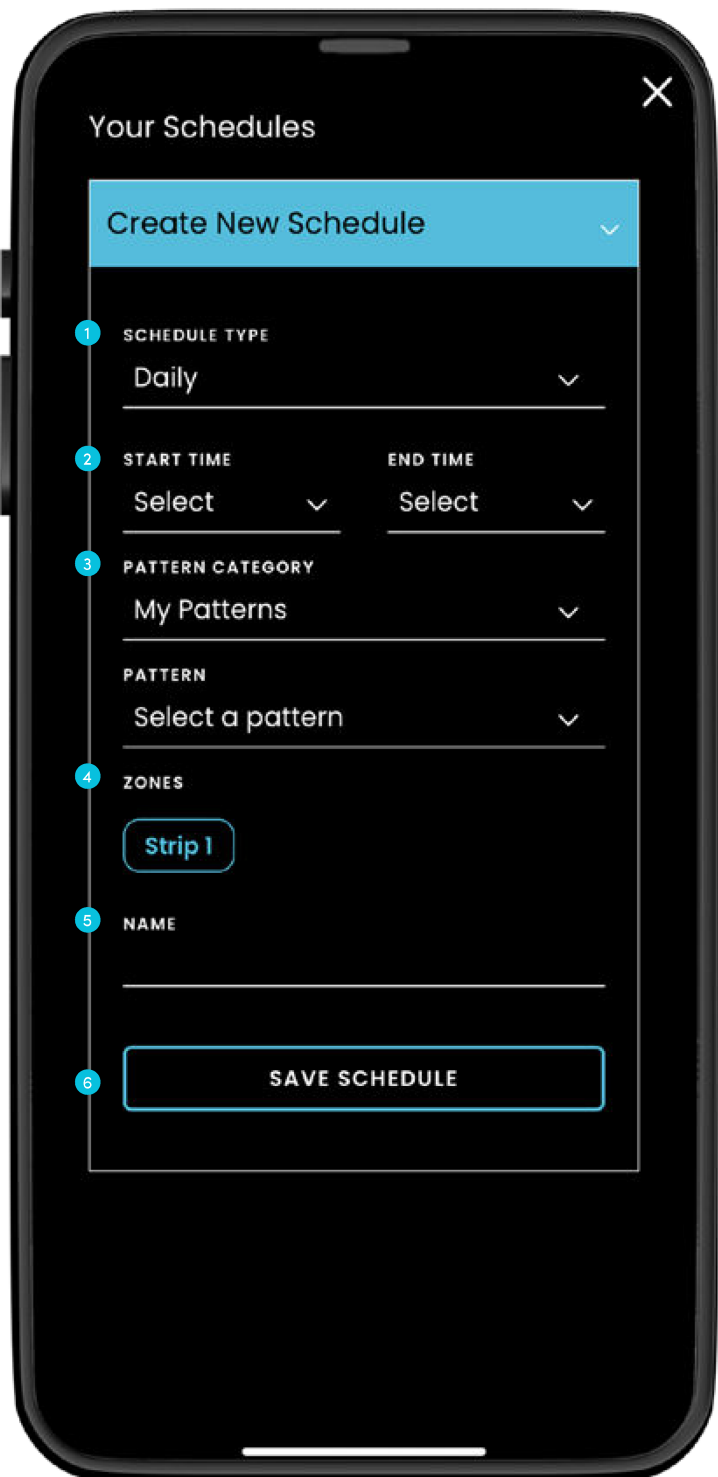



**STEP 3:** Tap the **SLIDER BUTTON** to enable/disable the schedule. Your lights will run automatically.

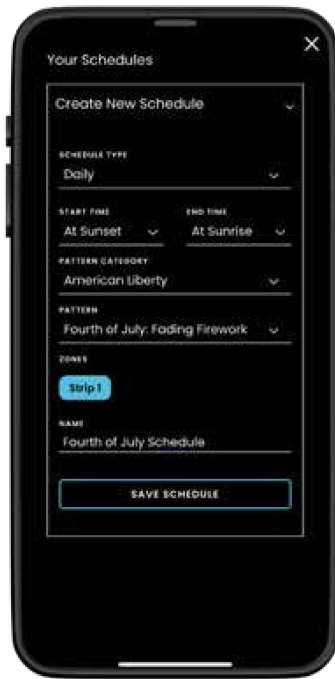

**STEP 4:** To modify existing schedules, tap **EDIT** to change the schedule. Tap **SAVE** to confirm the changes.

Never miss a holiday again by scheduling your lights well in advance!

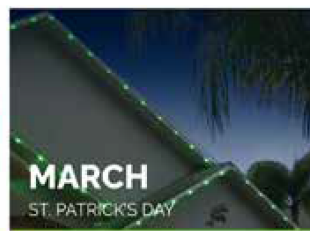

## SETUP TROUBLESHOOTING

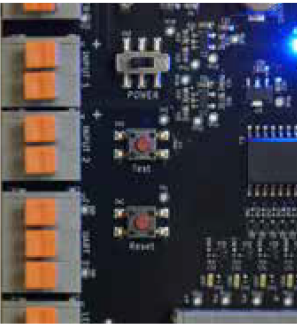

Things to Check	Additional Steps ...
<p><b>Verify your Controller is working properly</b></p> 	<p><b>Red Light:</b> The Controller is receiving power. (If this light is not illuminated, check that 1) a breaker hasn't been tripped, 2) the box is plugged in and 3) the Power Switch is flipped in the ON position (toward the orange connectors).</p> <p>If the Red Light is off and the above steps don't help, "re-boot" your box by unplugging and plugging it back in, then watch for the Blue Light to run through this series ...</p> <p><b>Blue Light Slow Flash:</b> The Controller is starting up, updating or attempting to connect.  <b>Blue Light Fast Flash:</b> The Controller is ready to connect to the App.  <b>Blue Light</b> indicates the Controller is connected.</p> <p>If the Blue Light is not flashing or stationary appropriately during the sequence, unplug your Control Box, plug it back in and re-launch your app and follow the Initial Setup Steps on <b>Page 3</b>.</p>
<p><b>Check your Oelo App permissions</b></p>	<p><b>A.</b> Navigate to your phone's <b>SETTINGS &gt; APPS &gt; OELO EVOLUTIONAPP &gt; PERMISSIONS</b>.  <b>B.</b> Allow the Oelo App access to the <b>LOCATIONS, NETWORK</b> and <b>DATA</b>.  <b>C.</b> Relaunch the Oelo App and follow the Initial Setup Steps on <b>Page 3</b>.</p>
<p><b>Update the light count in your Oelo App</b></p>	<p><b>A.</b> In the <b>CUSTOMER FOLDER</b> provided to you when you received your system, you will find your total light count.  <b>B.</b> In the app, tap the <b>SETTINGS ICON</b>, then <b>CONTROLLER SETTINGS</b>.  <b>C.</b> Update the <b>LED COUNT</b> for each <b>ZONE</b> to the correct amount. Hit <b>SAVE</b>.</p>
<p><b>Disconnect your Oelo system from power</b></p>	<p><b>A.</b> Flip the breaker associated with the Oelo system.  <b>B.</b> Flip the breaker back on and test that your lights work.</p>
<p><b>Restart your Oelo App</b></p>	<p><b>A.</b> Close your Oelo App and reopen it. If it is not fixed...  <b>B.</b> Uninstall then re-download the <b>OELO EVOLUTION</b> App from the Apple App Store or Google Play Store.</p>
<p><b>Factory reset the Control Unit</b></p> 	<p><b>A.</b> On the <b>CONTROL UNIT BOARD</b>, press and hold the <b>TEST</b> button for 5 seconds until the light strand turns <b>RED</b>.  <b>B.</b> Wait for the <b>BLUE</b> light on the <b>CONTROL UNIT BOARD</b> to start flashing quickly. This indicates that the Control Unit is ready to connect.  <b>C.</b> Relaunch the Oelo App and follow the Initial Setup Steps on <b>Page 3</b>.</p>

Things to Check	Additional Steps ...
<p><b>Verify your Controller is working properly</b></p> 	<p><b>Red Light:</b> The Controller is receiving power. (If this light is not illuminated, check that 1) a breaker hasn't been tripped, 2) the box is plugged in and 3) the Power Switch is flipped in the ON position (toward the orange connectors).</p> <p>If the Red Light is off and the above steps don't help, "re-boot" your box by unplugging and plugging it back in, then watch for the Blue Light to run through this series ...</p> <p><b>Blue Light Slow Flash:</b> The Controller is starting up, updating or attempting to connect.  <b>Blue Light Fast Flash:</b> The Controller is ready to connect to the App.  <b>Blue Light</b> indicates the Controller is connected.</p> <p>If the Blue Light is not flashing or stationary appropriately during the sequence, unplug your Control Box, plug it back in and re-launch your app and follow the Initial Setup Steps on <b>Page 3</b>.</p>
<p><b>Verify the antenna is connected properly</b></p> 	<ol style="list-style-type: none"> <li>A. Ensure the antenna is connected to the Controller. <b>Disconnect power first before touching the antenna!</b></li> <li>B. Firmly press down on the antenna attachment.</li> <li>C. Relaunch the Oelo App and follow the Initial Setup Steps on <b>Page 3</b>.</li> </ol>
<p><b>Restart your Oelo App</b></p>	<ol style="list-style-type: none"> <li>A. Close your Oelo App and reopen it. If it is not fixed...</li> <li>B. Uninstall then re-download the <b>OELO EVOLUTION</b> App from the Apple App Store or Google Play Store.</li> </ol>
<p><b>Disconnect your Oelo system from power</b></p>	<ol style="list-style-type: none"> <li>A. Flip the breaker associated with the Oelo System.</li> <li>B. Flip the breaker back on and test that your lights work.</li> </ol>
<p><b>Restart your Oelo App</b></p> 	<ol style="list-style-type: none"> <li>A. On the <b>CONTROL UNIT BOARD</b>, press and hold the <b>TEST</b> button for 5 seconds until the light strand turns <b>RED</b>.</li> <li>B. Wait for the <b>BLUE</b> light on the <b>CONTROL UNIT BOARD</b> to start flashing quickly. This indicates that the Control Unit is ready to connect.</li> <li>C. Relaunch the Oelo App and follow the initial setup steps on <b>Page 3</b>.</li> </ol>

Issue	Solution
<p><b>My lights don't turn on</b></p> 	<p><b>Solution 1 – Reset your system:</b> If you have not used your Oelo System frequently, it may need a reboot.</p> <p><b>A.</b> Turn off your system and unplug it for 10 minutes.  <b>B.</b> If Step A does not work, flip the breaker that your system is connected to.</p> <p><b>Solution 2 - Verify that your Control Unit is working properly:</b> A working Oelo System will have 2 lights on inside the Control Unit, <b>1 RED</b> and <b>1 BLUE</b>.</p> <p><b>Red Light:</b> The Controller is receiving power. (If this light is not illuminated, check that 1) a breaker hasn't been tripped, 2) the box is plugged in and 3) the Power Switch is flipped in the ON position (toward the orange connectors).</p> <p>If the Red Light is off and the above steps don't help, "re-boot" your box by unplugging and plugging it back in, then watch for the Blue Light to run through this series ...</p> <p><b>Blue Light Slow Flash:</b> The Controller is starting up, updating or attempting to connect.  <b>Blue Light Fast Flash:</b> The Controller is ready to connect to the App.  <b>Blue Light</b> indicates the Controller is connected.</p> <p>If the Blue Light is not flashing or stationary appropriately during the sequence, unplug your Control Box, plug it back in and re-launch your app and follow the Initial Setup Steps on <b>Page 3</b>.</p>
<p><b>My lights won't shut off</b></p>	<p><b>Solution 1 - Turn Off All Zones:</b> In the Oelo App, tap <b>ZONES OFF</b> on the bottom bar.</p> <p><b>Solution 2 - Restart your Oelo App:</b> Close your Oelo App and reopen it, attempting to turn the lights off.</p> <p><b>Solution 2 - Factory reset your Oelo System:</b> On the <b>CONTROL UNIT BOARD</b>, press and hold the <b>TEST</b> button for 5 seconds until the light strand turns <b>RED</b>. Wait for the <b>BLUE</b> light on the <b>CONTROL UNIT BOARD</b> to start flashing quickly. This indicates that the Control Unit is ready to connect. Relaunch the Oelo App.</p>
<p><b>Only a portion of my lights respond</b></p>	<p><b>Solution 1 - Update Light Count in the Oelo App:</b></p> <p><b>A.</b> In the app, tap the <b>SETTINGS ICON</b>, then <b>CONTROLLER SETTINGS</b>.  <b>B.</b> Update the <b>LED COUNT</b> for each <b>ZONE</b> to the correct amount. Hit <b>SAVE</b>.</p> <p><b>Solution 2 - Factory reset your Oelo System:</b> On the <b>CONTROL UNIT BOARD</b>, press and hold the <b>TEST</b> button for 5 seconds until the light strand turns <b>RED</b>. Wait for the <b>BLUE</b> light on the <b>CONTROL UNIT BOARD</b> to start flashing quickly. This indicates that the Control Unit is ready to connect. Relaunch the Oelo App and follow the initial setup steps on <b>Page 3</b>.</p>
<p><b>One or more LEDs won't turn on</b></p>	<p><b>Solution 1 - Update Light Count in the Oelo App:</b></p> <p><b>A.</b> In the app, tap the <b>SETTINGS ICON</b>, then <b>CONTROLLER SETTINGS</b>.  <b>B.</b> Update the <b>LED COUNT</b> for each <b>ZONE</b> to the correct amount. Hit <b>SAVE</b>.</p> <p><b>Solution 2 - Replace the LED(s).</b> (See <a href="http://oelo.com/troubleshooting">oelo.com/troubleshooting</a> for instructions.)</p>

## COMMON INSTALLATION MISTAKES

### WIRING SYSTEM

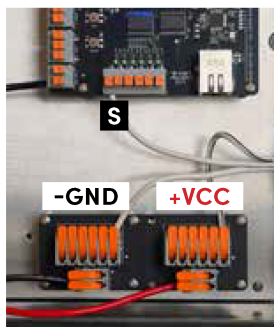

#### Common Mistakes: Connecting the 3-Core Wire to Control Unit:

- A. Insert the **-GND** 3-Core Wire to the **BLACK CONDUCTOR OUTPUT**. Clamp the Conductor down.
- B. Insert the **S** 3-Core Wire to lowest numbered **S-Port (numbered 1-6)**.
- C. Insert the **+VCC** 3-Core Wire to the **RED CONDUCTOR OUTPUT**. Clamp the Conductor down.

**Note:** Make sure there is no wiring left exposed when the Conductors are clamped down.

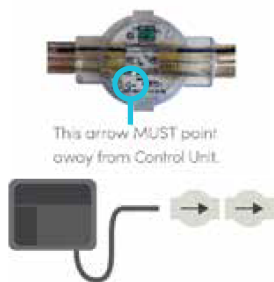

#### Common Mistakes: Facing the Output Arrow in the right direction:

- A. Check your connections to verify that the output arrow, located on each Light Puck, is pointing **AWAY** from the Control Unit.
- B. If the arrow is not pointing away from the Control Unit, you will have to cut out that Light Strand section and reverse the orientation.
- C. You can learn how to replace an LED at [oelo.com/troubleshooting](http://oelo.com/troubleshooting).
- D. After verifying that all arrows are facing the correct direction, test the system.

#### Installing Jumper Core Cables

#### Common Mistakes: Installing Jumper Cables:

- A. Strip the Light Strand's **"S"** and **"VCC"** wires.
- B. Strip the 3-Core Jumper Cable's **"GND"**, **"S"** and **"VCC"** wires.
- C. Using Butt Connectors, insert the wires, connecting **GND-GND**, **S-S** and **VCC-VCC**.
- D. Crimp the Butt Connectors on both side of the center silver line.
- E. Using a Butane torch, apply heat to the connectors, shrinking them completely.
- F. Repeat steps **A-E** on the other end of the Jumper Cable with a new Light Strand and continue wiring.

If your system is still not functioning after following solution instructions, please fill out our Troubleshooting Form (to specify a contact time) at:

[oelo.com/troubleshooting](http://oelo.com/troubleshooting)

OR call our troubleshooting desk at: [970-212-3676](tel:970-212-3676)



## Materials Reference Link

MANUALS	Acrylic Installation Manual	<a href="https://oelo.com/resources/manuals">oelo.com/resources/manuals</a>
	Metal Installation Manual	<a href="https://oelo.com/resources/manuals">oelo.com/resources/manuals</a>
	Oelo Evolution Guide	<a href="https://oelo.com/resources/manuals">oelo.com/resources/manuals</a>
CONTACT	Troubleshooting Support Form	<a href="https://oelo.com/troubleshooting">oelo.com/troubleshooting</a>
	Phone	<a href="tel:970-212-3670">970-212-3670</a>
	Email	<a href="mailto:lightyourspace@oelo.com">lightyourspace@oelo.com</a>

## Specifications

- Product Name: Oelo Multi-Color Lighting System
- Compatibility: Works with Alexa and Google Home
- Control: Oelo Evolution App
- Connectivity: WiFi
- Manufacturer: OELO LIGHTING SOLUTIONS

[www.oelo.com](https://www.oelo.com) | 970.212.3670 | 3842 Redman Dr., Fort Collins, CO  
User Manual was last updated 03.24, ©2024 Oelo

## Frequently Asked Questions (FAQ)

### If I Can't Connect to WiFi?

**Solution:** Check the Control Box Antenna.  
Disconnect power, ensure antenna connection, and rerun setup.

## Documents / Resources



[Oelo Evolution App \[pdf\] User Manual](#)  
Evolution App, Evolution, App

## References

- [O Best Permanent Christmas Lights & Commercial LED Lighting | Oelo Lights](#)
- [O Troubleshooting Directory - Oelo](#)
- [O Best Permanent Christmas Lights & Commercial LED Lighting | Oelo Lights](#)
- [O Troubleshooting Directory - Oelo](#)
- [User Manual](#)

### Manuals+, Privacy Policy

This website is an independent publication and is neither affiliated with nor endorsed by any of the trademark owners. The "Bluetooth®" word mark and logos are registered trademarks owned by Bluetooth SIG, Inc. The "Wi-Fi®" word mark and logos are registered trademarks owned by the Wi-Fi Alliance. Any use of these marks on this website does not imply any affiliation with or endorsement.