

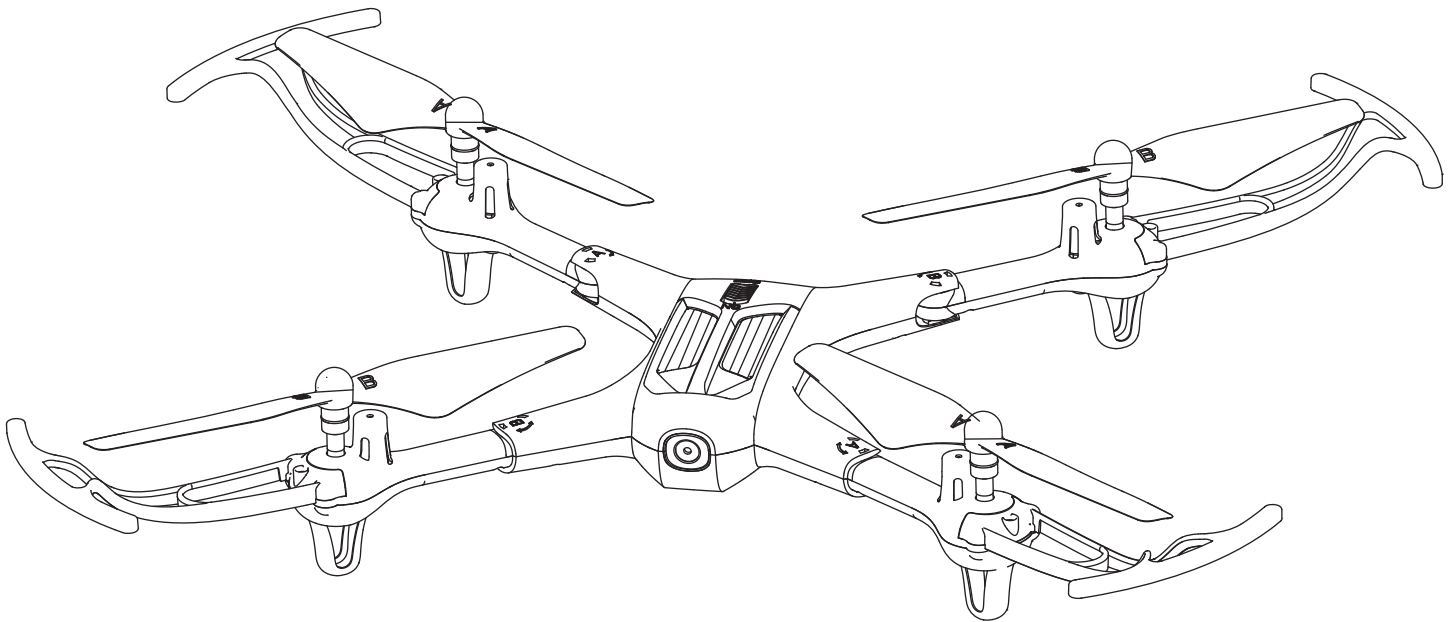

INSTRUCTIONS FOR USE

X600W

Folding drone



☎ +1 718-312-0558 (US)
+44(0)7723708421 (UK)
+49 335-4551-9201 (DE)
✉ usa@symatoys.com(US)
eu@symatoys.com(EU)
🔍 <http://www.symatoys.com>

English Manual: Page 1-14
Deutsche Anleitung: Seite 15-29

Accreditation standard: GB/T26701-2011

The materials, specifications, parts and packaging mentioned in this manual are for reference purposes only. We are not responsible for any changes made to this printed material, nor are we able to inform customers of any updates or changes. Please refer to the SYMA Toys website for the latest information.

Important safety information

Thank you for purchasing this SYMA product. To ensure that you operate the aircraft correctly, please read these instructions carefully before first use and store them in a safe place for future reference.

Safety information

- * Keep the smaller-sized accessories out of the reach of children.
- * This aircraft can move very quickly. When flying for the first time, push left joystick up slowly to prevent the aircraft from ascending too rapidly and causing damage or collisions.
- * When the flight has ended, switch off the remote control before switching off the power on the aircraft.
- * Do not store the battery in a hot environment (e.g. near open flames or a heating device).
- * When the drone is airborne, it should be kept at least 2-3m away from the pilot and other people to avoid the risk of a collision during landing.
- * This product is suitable for users aged 8 years or above. Not Safe for users under the age of 8 to use without adult supervision.
- * Do not recharge non-rechargeable batteries. When installing or changing the batteries, ensure that they are connected in the correct polarity. Do not mix old and new batteries or different types of batteries. Exhausted batteries are to be removed from the toy.
- * Do not short circuit the battery terminals
- * If you do not plan to use the drone for at least 10 days, discharge the battery to 40%-50% (i.e. if the battery is fully charged, drive the drone for half of the total driving time). This helps to prolong the lifespan of the battery.
- * Maintain a safe distance from the spinning propellers to avoid the risk of injury.
- * In order to prevent interference with air traffic control systems, it is forbidden to use remote controls within a 5000m radius of an airport runway (calculated from the centre of the runway). Always comply with remote control restriction orders issued by national authorities.
- * You must only use the recommended transformer for this model. The transformer is not part of the toy. Regularly inspect the transformer's wires, plug socket, outer casing and other accessories to ensure that they are not damaged. If there are any signs of damage, discontinue use immediately until the fault has been repaired.
- * After using, ensure that the drone and remote control are switched off and remove the batteries in the remote control.
- * The packaging and this manual contain important information and should be kept in a safe place for future reference.
- * Do not look directly at the laser beam.

Repair and maintenance

- * Clean the product regularly with a clean, soft cloth.
- * Avoid exposing the product to direct sunlight or heat.
- * Do not submerge the product in water, as this may damage the electrical components.
- * Regularly inspect the propellers, motor and battery. If there are any signs of damage, discontinue use immediately until the fault has been repaired.

About this product

Specifications

·Aircraft

Brand Name: SYMA	
Model/ITEM NO: X600W	
Weight Aircraft	Approx. 67 g
Specifications	311x293x53.6 mm
Flight range	Approx.30 m
Flight Altitude	Approx.10 m
Flight time	Approx.10 mins
Motor	ø6
Battery	3.7 V, 400 mAh
Battery Charging time	Approx. 60 min

·Remote control

Operating frequency	2.4 GHz
Operating temperature	0°Cto 40°C

·Package

contents

Aircraft	1
Remote	1
USB charging cable	1
Propeller	4 (A\B)
Propeller protection frame	2
User manual	1
Phone holder	1

Download the SYMA FLY app and watch the video tutorial

Installing the SYMA FLY app

Scan the QR code with your mobile device or download the app from your app



QR code for android system



QR code for apple iOS system

* Note: For best results, use a device with iOS 8.0/Android 5.0 or later.

Aircraft components

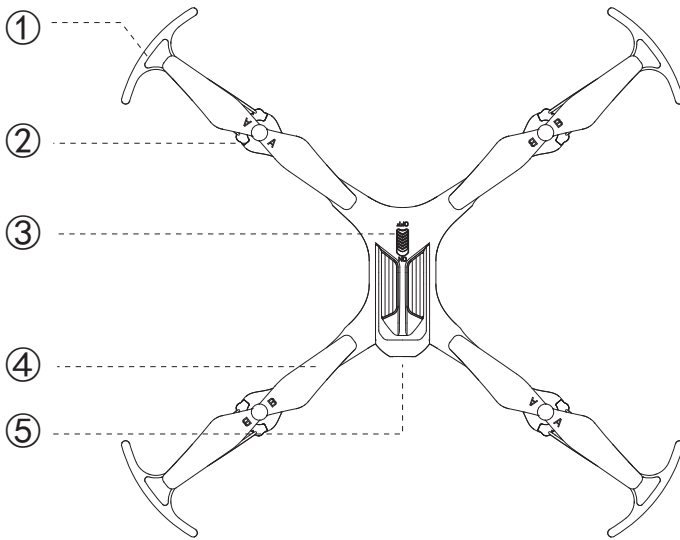

- ① Propeller protection frame
- ② Motor
- ③ Power switch
- ④ Propellers
- ⑤ Lens

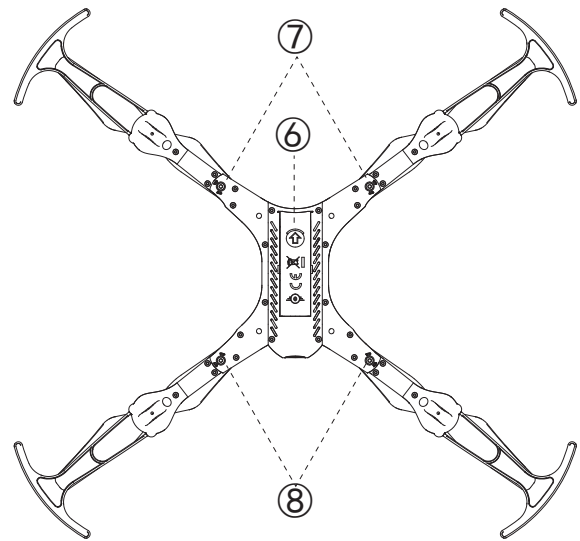

- ⑥ Battery cover
- ⑦ Rear indicator
- ⑧ Front indicator

Remote control components

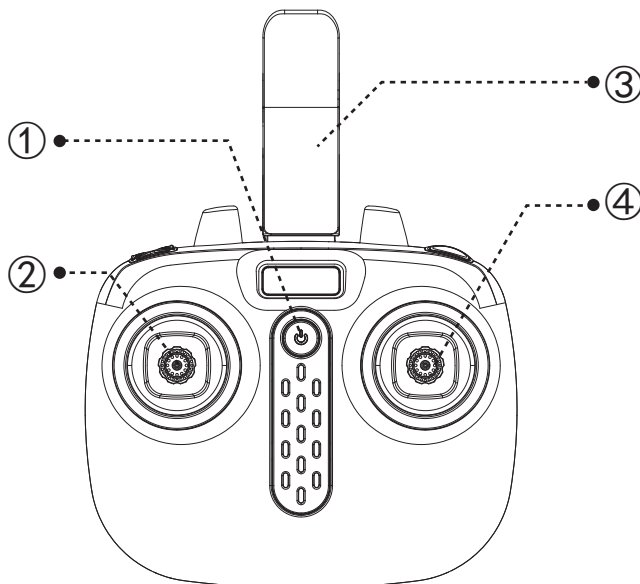

- ① Power switch
- ② Left joystick
- ③ Phone holder
- ④ Right joystick
(short press to toggle between high and low speed mode)

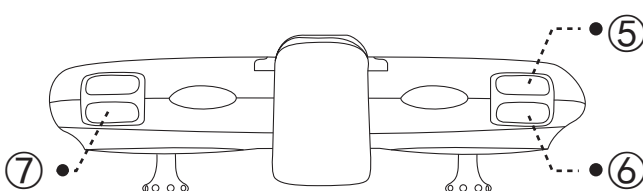

- ⑤ 3D flip button
- ⑥ One-touch take-off/landing button
- ⑦ Spin button

Assembling the product

Folding the quadcopter

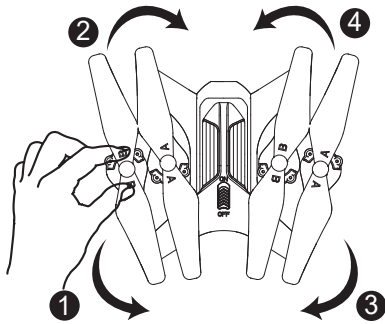

1. Unfold the arms in the direction of the arrow

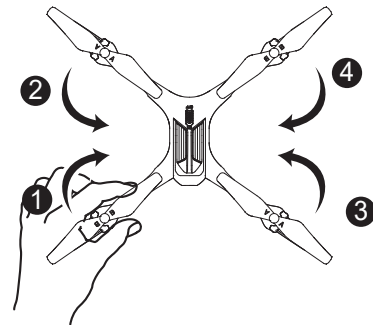

2. Fold the arms in the direction of the arrow until the quadcopter is fully folded.

Detaching the propellers

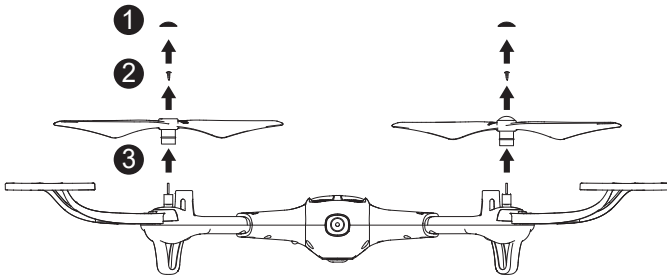

Remove the propeller covers and screws in the direction of the arrow,

Note: The propellers are labelled "A/B". Ensure that each propeller is inserted in the corresponding position on the arms, and then tighten the screw, and then tighten the screws and attach the propeller covers.

Re-installing the propellers

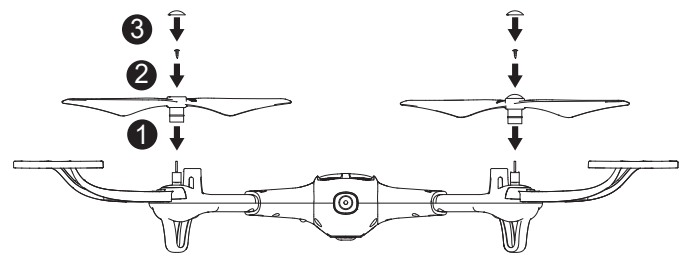

Insert the propellers onto the body of the quadcopter in the direction of the arrow,

Installing the propeller protectors

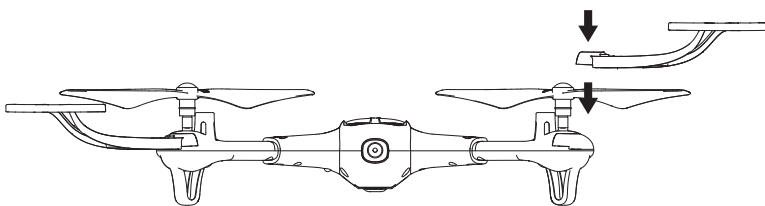

Insert the protective frame into the fuselage in the direction of the arrow, and fasten the screws.

Attaching the phone holder

Insert the phone holder into the opening on the remote control.

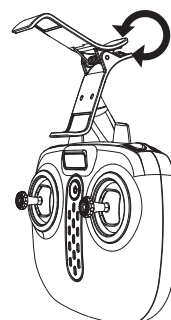
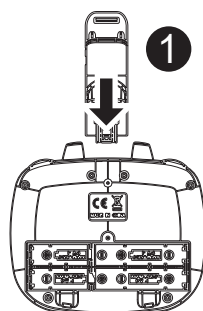

Press the spring to adjust the size of the phone holder.

Charging the aircraft battery

Removing the battery

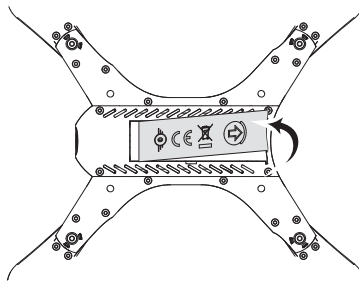

Push the battery cover back, then flip it up to remove the battery

Charging the aircraft battery

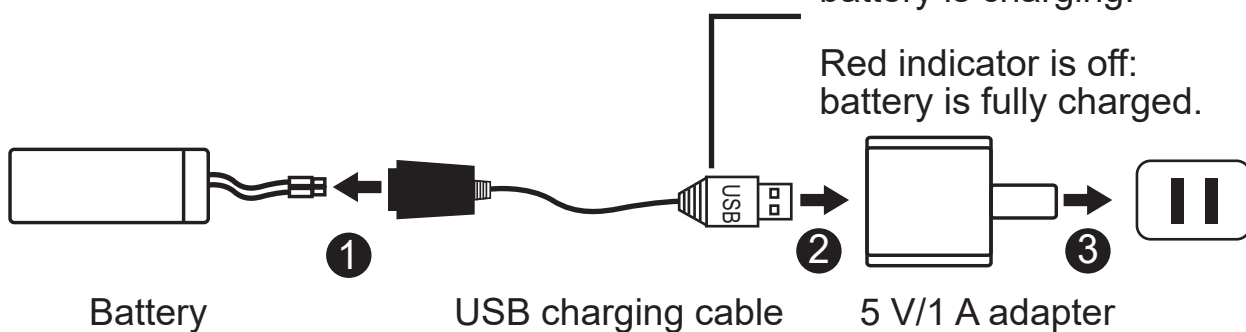

- * Charge the drone with the USB charging cable that came with the product.
- * Using adapters with a lower rated current will result in a longer charging time.

Inserting the battery

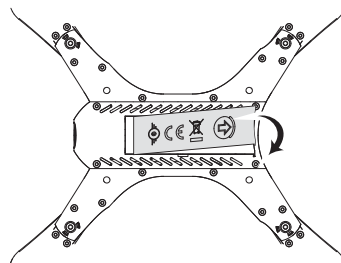

Insert the battery and close the battery compartment cover.

- * Ensure that the battery holder clicks into place.



- * Do not short circuit or compress the battery, as this may cause an explosion.
- * Rechargeable batteries should be removed from the aircraft before charging.
- * Failure to follow all the instructions may result in serious injury, irreparable damage to the battery and may cause a fire, smoke or explosion.
- * Always check the battery's condition before charging or using it.
- * Replace the battery if it has been dropped, or in case of an odor, overheating, discolouration, deformation or leakage.
- * Use only the supplied charging cable.
- * Exhausted batteries should be removed from the aircraft.

- *The battery temperature must never exceed 60 °C (140°F), otherwise the battery could be damaged or ignite.
- * Never charge on a flammable surface , near flammable products or inside a vehicle (Preferably place the battery in an on-flammable and nonconductive container).
- * Never leave the battery unattended during the charging process . Never disassemble or modify the housing's wiring, or puncture the cells. Always ensure that the charger output voltage corresponds to the voltage of the battery . Do not short circuit the batteries .
- * Never expose the battery to moisture or direct sunlight, or store it in a place where temperatures could Exceed 60 °C (drone in the sun, for example)
- * Improper battery use may result in a fire, explosion or other hazard.

Inserting the remote control batteries

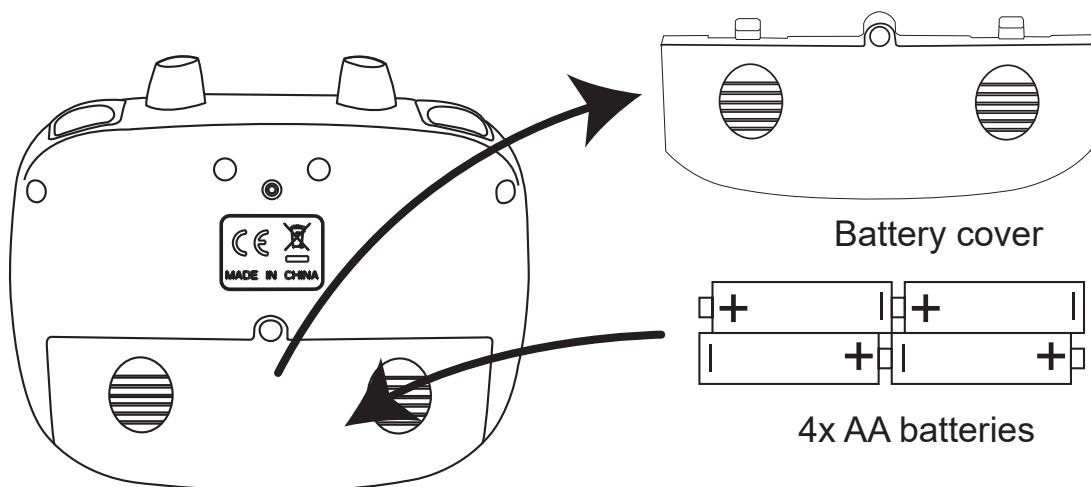

To insert the controller batteries, open the battery cover on the back of the remote control and insert 4x AA alkaline batteries, ensuring that you observe the polarity markings (batteries are not included and must be purchased separately).



- * When installing the batteries, ensure that you match the + and – ends of the battery with the + and – signs on the controller.
- * During the battery installation, it must be ensured that the polarities of the batteries are matched with that of the battery box. No battery shall be installed with the opposite polarity.
- * Please do not use new and old batteries together.
- * Please do not use different types of batteries together.
- * Remote control do not use rechargeable batteries.
- * Exhausted batteries are to be removed from the Remote control.

Flight preparation and turning the aircraft on/off

Pairing the remote control with the aircraft

Remote control indicator
flashes rapidly

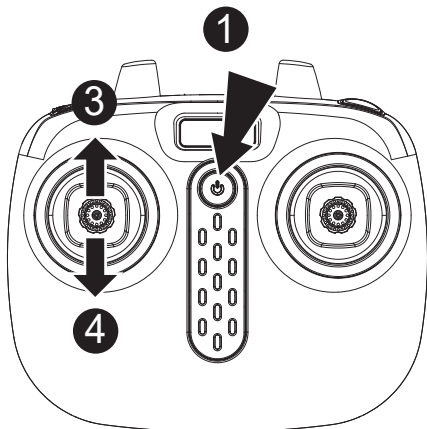

Switch on the remote control
Indicator flashes rapidly ≥ slowly

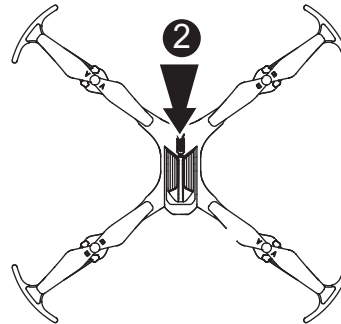

The indicator will stay constant
when pairing is complete.



After you switch on the remote control, the indicator will flash quickly to indicate that the remote control is waiting to be paired with the drone.

Turning the quadcopter on

Method one:

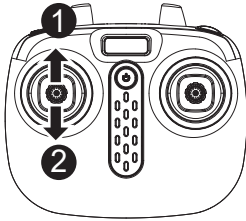

Push to the top and then return to the central position.

Method two:

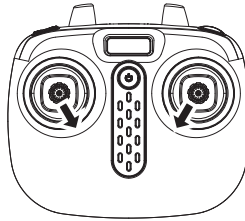

Pull the joysticks in a V shape

Method three:

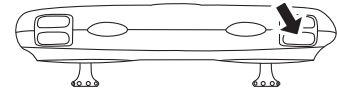

Press the ascend/descend button

Note: 1. If the aircraft is flown out of range from the remote control, the aircraft indicator light will start to flash and the aircraft will land slowly.
2. If the remote control suddenly turns off or runs out of power during flight, the aircraft will automatically land and come to a stop. If the remote control is turned back on during this process, you will be able to control the aircraft again.

Turning the drone off

Method one:

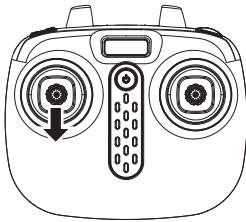

Push to the bottom for 2-3 seconds

Method two:

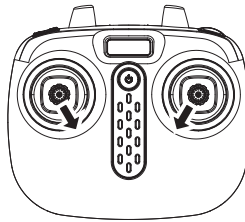

Pull the joysticks in a V shape

Method three:

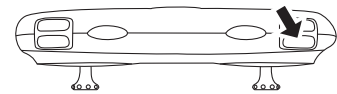

Press the ascend/descend button

Using the remote control

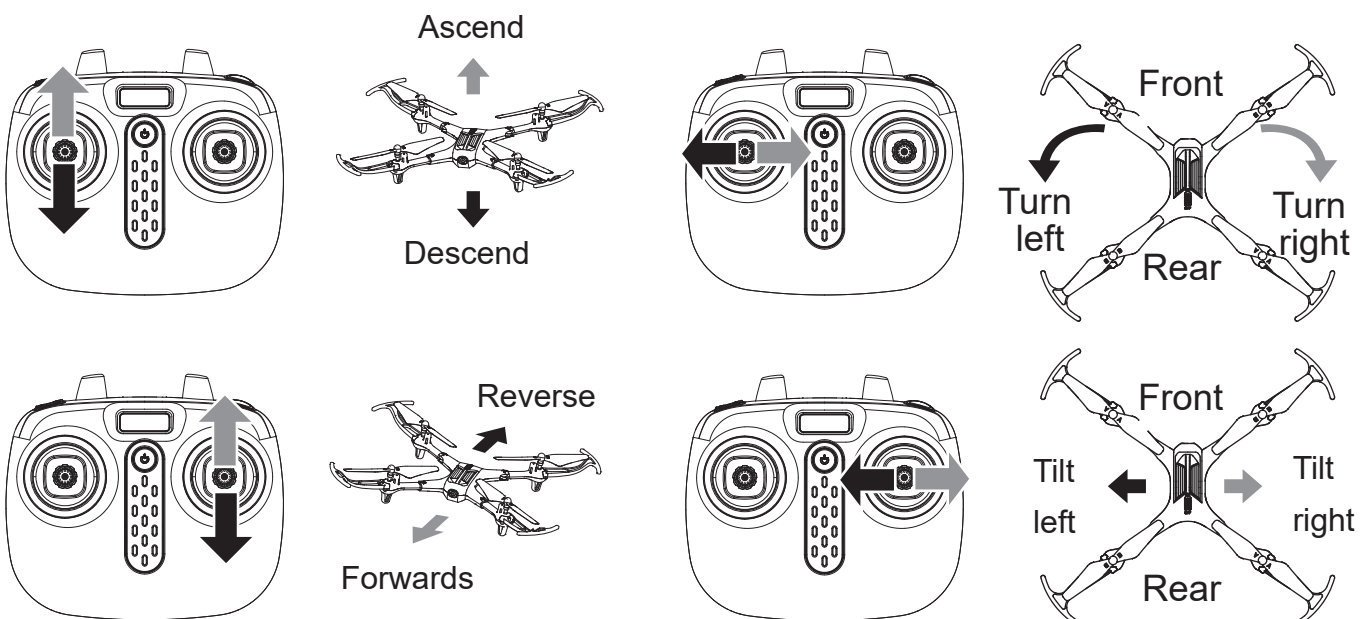

Stunt functions

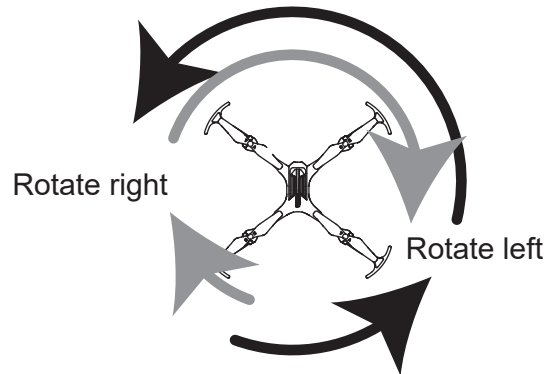
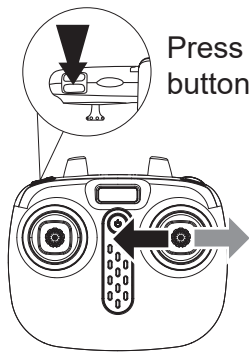

Press the spin button on the top-left of the remote control while holding the right joystick to the left or right. The drone will spin to the left or right accordingly.

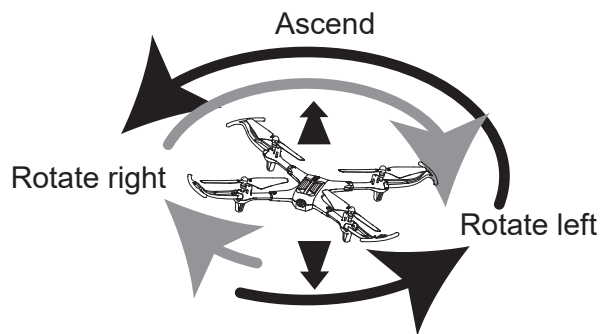
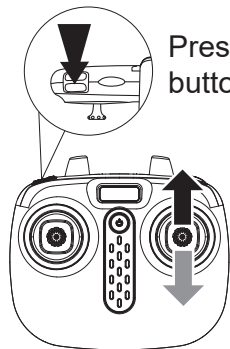

Press the spin button on the top-left of the remote control and move the right joystick to the top or bottom. The drone will spin in circles and ascend for approximately 60-90cm.

Maximum radio-frequency power transmitted < 10 dBm. Frequency range:2409-2475MHZ

Trimming

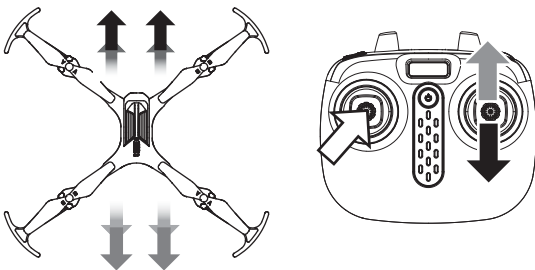

Trimming forwards and backwards

If the aircraft drifts forwards or backwards when it is hovering, hold the left joystick down and push the right joystick down/up until the aircraft stops drifting.

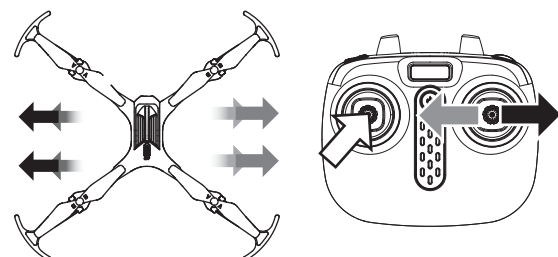

Trimming left and right

If the aircraft drifts to the left or right when it is hovering, hold the left joystick down and push the right joystick right/left until the aircraft stops drifting.

This toy is only to be connected to equipment bearing either of the following symbols:



Stunt functions

Undervoltage



Undervoltage protection

A flashing red indicator light on the base of the aircraft indicates that the battery level is low. When this occurs, bring the aircraft back to land.

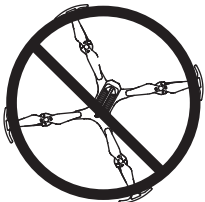

Overcurrent protection

If the aircraft's blades collide with another object or become stuck, the aircraft's circuit will engage the overcurrent protection mechanism.

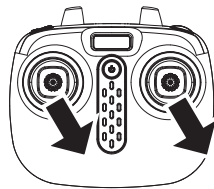
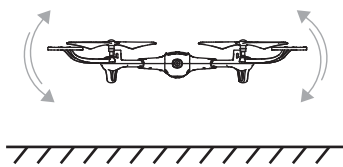

Level calibration

Place the aircraft on a level surface and move the left and right joysticks to the lower right corner for approximately 3 seconds. The indicator will flash rapidly and then stay constant to indicate that the calibration process is complete.

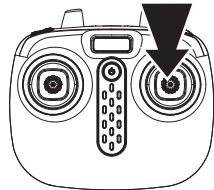
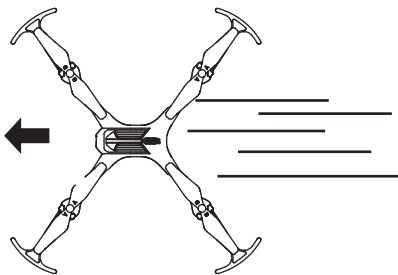

High/low speed mode

Briefly press the right joystick to switch between high and low speed mode.

1. Low speed mode is enabled by default when the aircraft is switched on.
2. The remote control beeps twice when high speed mode is enabled and once when low speed mode is enabled.

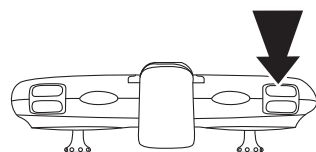
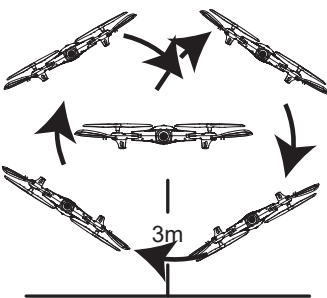

Once you have mastered the basic controls, you can try performing some flip manoeuvres. Start by flying the drone to an altitude of at least 3 m. Then hold down the button on the top-right corner of the remote control (flip button) and push the right joystick all the way up/down/left/right to flip the aircraft forward/backwards/left/right.

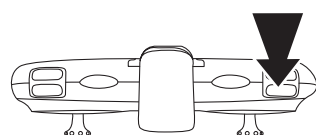
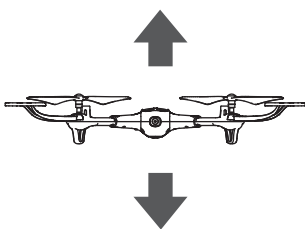

One-touch take-off/landing

1. When the aircraft is in standby, press the take-off button to make the aircraft take off automatically and hover at a height of 1.5 m.
2. When the drone is in the air, press the one-touch take-off/landing button to make the aircraft land automatically.

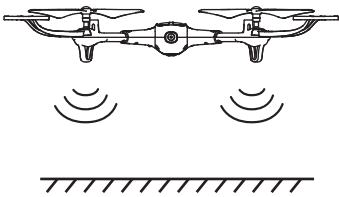

Atmospheric pressure positioning
When you release the left joystick (throttle) after ascending/descending, the drone will continue to hover at the current height.

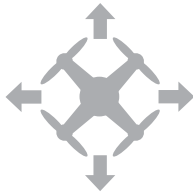

1. Define the front

When the aircraft is powered on for the first time, the direction of the aircraft nose is straight ahead.

2. Start headless function

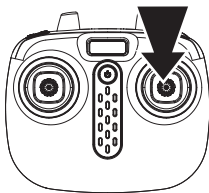

Headless mode

After the linking is completed, press and hold the right joystick (about 2S), the remote controller will emit a "dididi..." sound, and the indicator light on the aircraft will flash slowly, indicating that it has entered the headless state; press and hold the right joystick again (about 2S). When you hear a long beep, you will exit the headless state.

In the headless state, the controller does not need to identify the position of the aircraft's nose, but to control the aircraft according to the direction of the joystick of the remote control.

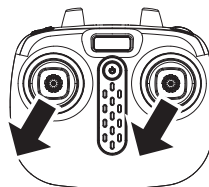

Define the positive direction function correction:

When the aircraft collides with a headless state, if you find that the fixed head direction is deviated, you only need to re-orient the aircraft and move the left and right joysticks of the remote control to the lower left at the same time. When the indicator on the aircraft flashes slowly 3 A long light after a second indicates that the calibration is complete.

Real-time transmission function

1. Download and install the app.

If you have an Android device, download the SYMA FLY app from the Syma website (www.symatoys.net), or scan the QR code shown.

If you have an iOS device, download the Syma Fly app from the Apple App Store, or scan the QR code shown.

Note: The QR code is printed on the packaging and on the back cover of the user manual. Visit the Syma website or your app store to download the latest version of the Syma Fly app.

2. Follow the in-app instructions

Accessories (available separately)

The following section contains a list of optional accessories that are available to purchase. Accessories can be purchased from your local retailer. Please indicate your preferred colour when making your purchase.



Body



Arm



Propeller protection
frame



Box



Propeller
blades

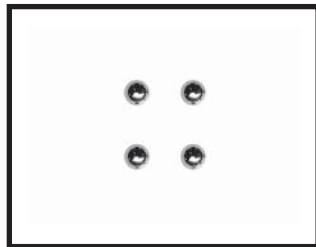

Propeller
decorations

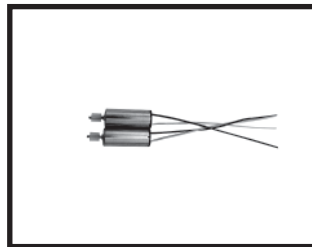

Motor A

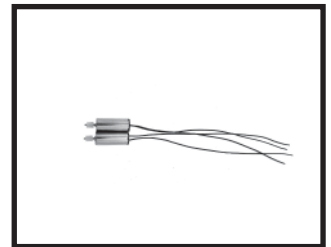

Motor B



Lights



Battery

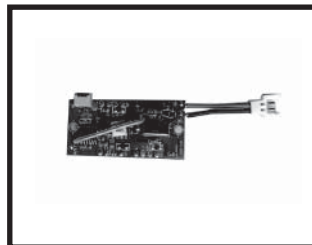

Receiver
board



USB cable



Remote
control



Phone
holder

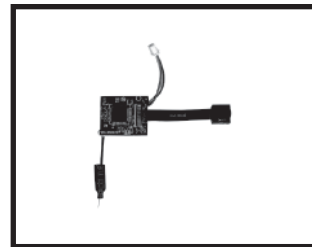

Camera
circuit board

Rectification Procedures

Problem	Reason	Solution
The drone has no response	<ol style="list-style-type: none"> 1. The drone has entered into low-voltage protection. 2. When the power of the remote control is weak, the power light indicator will blink. 	<ol style="list-style-type: none"> 1. Charge up the drone. 2. Change the batteries of the remote control.
The flight response of the drone is not sensitive	<ol style="list-style-type: none"> 1. The power of the remote control is weak. 2. There is an interference with the same frequency as that of the remote control. 	<ol style="list-style-type: none"> 1. Change the batteries. 2. Change to a place where there is no interference with the same frequency.
<p>The drone is flying towards its side in one direction during hovering</p> <p>In the headless state, it is biased towards the front direction</p>	<ol style="list-style-type: none"> 1. The drone is not calibrated level to the ground. 1. Many collisions may cause head drift. 	<ol style="list-style-type: none"> 1. Re-adjust the calibration until the drone is level to the ground. For further details, 1. Re-define the front direction. For further details,
Fixed high instability / up and down movement	<ol style="list-style-type: none"> 1. The drone is not calibrated level to the ground. 2. Unstable air pressure under the severe weather condition. 3. Violent collision resulting in data disorder of gyroscope. 	<ol style="list-style-type: none"> 1. Re-adjust the calibration until the drone is level to the ground. For further details, 2. Avoid to fly under the severe weather condition. 3. Make level adjustment again,

European Representative:
 CET PRODUCT SERVICE LTD.
 Osterholzallee 144
 71636 Ludwigsburg Germany
 Phone: +4971416432236
 Email: info.cetservice@gmail.com

British Representative:
 CET PRODUCT SERVICE LTD.
 Chase Business Centre, 39-41 Chase Side,
 London N14 5BP United Kingdom
 E-mail: info.cetservice@gmail.com Tel: +447419325266

United States Representative:
 Duvin Trade Inc
 5800 Wood Sorrel Dr, Littleton, Co, 80123, United States
 Phone: 718-312-0558
 E-mail: amz@symatoys.com

SYMA is a trademark of Guangdong Syma Model Aircraft Industrial Co., Ltd. registered in the United States and/or other countries.

Warning: Changes or modifications to this unit not expressly approved by the party responsible for compliance could void the user's authority to operate the equipment.

NOTE: This equipment has been tested and found to comply with the limits for a Class B digital device, pursuant to Part 15 of the FCC Rules. These limits are designed to provide reasonable protection against harmful interference in a residential installation. This equipment generates, uses and can radiate radio frequency energy and, if not installed and used in accordance with the instructions, may cause harmful interference to radio communications. However, there is no guarantee that interference will not occur in a particular installation. If this equipment does cause harmful interference to radio or television reception, which can be determined by turning the equipment off and on, the user is encouraged to try to correct the interference by one or more of the following measures:

- Reorient or relocate the receiving antenna.
- Increase the separation between the equipment and receiver.
- Connect the equipment into an outlet on a circuit different from that to which the receiver is connected.
- Consult the dealer or an experienced radio/TV technician for help.

Changes or modifications not expressly approved by the party responsible for compliance could void the user's authority to operate the equipment.

This device complies with Part 15 of the FCC Rules. Operation is subject to the following two conditions:

- (1) This device may not cause harmful interference, and
- (2) This device must accept any interference received, including interference that may cause undesired operation.

"This device complies with FCC radiation exposure limits set forth for general population (uncontrolled exposure). This device must not be collocated or operating in conjunction with any other antenna or transmitter."

Sold to EU country
product name: [DRONE]
model number: X600w
Brand name :SYMA

Hereby, [GUANGDONG SYMA MODEL AIRCRAFT INDUSTRIAL CO., LTD], declares that this [drone] is in compliance with Directive 2014/53/EU. The full test of the EU declaration of conformity is available at the following internet address:

<http://www.symatoys.com/down/declaration-of-conformity.html>

Manufacturer:
Guangdong SYMA Model Aircraft Industrial Co., Ltd.
No.2 West Xingye Road, intersection of North Xingye Road,
Laimei Industrial Park, Chenghai District, Shantou City, Guangdong Province, China
Postal Code: 515800

Contact Us

Please do not hesitate to contact us if you need more further support



warranty@symatoys.com.cn

+1 718-312-0558(US)

+44 (0)7723708421(UK)

+4933545519201(DE)



For online support, please scan this code with Facebook Messenger



The company has the right of final interpretation of this user manual.

