

# RENOGY

## Monocrystalline Foldable Solar Suitcase with Voyager

100W/200W | 20A

RNG-KIT-STCS100D-VOY20/RNG-KIT-STCS200D-VOY20

VERSION A0  
September 6, 2024



USER MANUAL

## Before Getting Started

The user manual provides important operation and maintenance instructions for RENOZY 100W/200W Monocrystalline Foldable Solar Suitcase with Voyager (hereinafter referred to as solar suitcase).

Read the user manual carefully before operation and save it for future reference. Failure to observe the instructions or precautions in the user manual can result in electrical shock, serious injury, or death, or can damage the solar suitcase, potentially rendering it inoperable.

- Renogy ensures the accuracy, sufficiency, and the applicability of information in the user manual at the time of printing due to continual product improvements that may occur.
- Renogy assumes no responsibility or liability for personal and property losses, whether directly and indirectly, caused by the user's failure to install and use the product in compliance with the user manual.
- Renogy is not responsible or liable for any failure, damage, or injury resulting from repair attempts by unqualified personnel, improper installation, or inappropriate operation.
- The illustrations in the user manual are for demonstration purposes only. Details may appear slightly different depending on product revision and market region.
- Renogy reserves the right to change the information in the user manual without notice. For the latest user manual, visit [renogy.com](https://www.renogy.com).

## Disclaimer

RENOZY 100W/200W Solar Suitcase with 20A Voyager User Manual © 2024 Renogy. All rights reserved.

RENOZY and **RENOZY** are registered trademarks of Renogy.

- All information in the user manual is subject to copyright and other intellectual property rights of Renogy and its licensors. The user manual may not be modified, reproduced, or copied, in whole or in part, without the prior written permissions of Renogy and its licensors.
- The registered trademarks in the user manual are the property of Renogy. The unauthorized use of the trademarks is strictly prohibited.

## Online Manual

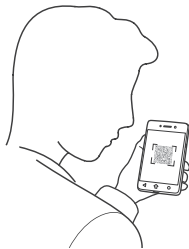

User Manual





# Table of Contents

<b>Symbols Used</b> .....	<b>1</b>
<b>Introduction</b> .....	<b>1</b>
<b>Key Features</b> .....	<b>1</b>
<b>SKU</b> .....	<b>1</b>
<b>What's In the Box?</b> .....	<b>2</b>
<b>Get to Know Renogy Solar Suitcase with Voyager</b> .....	<b>2</b>
<b>Dimensions</b> .....	<b>3</b>
<b>System Setup</b> .....	<b>4</b>
<b>Step 1. Unfold and Install the Solar Panels</b> .....	<b>4</b>
<b>Step 2. Connect the Voyager Charger Controller to a Battery</b> .....	<b>5</b>
<b>Step 3. Connect the Solar Panels to the Voyager</b> .....	<b>6</b>
<b>Step 4. Install a Battery Temperature Sensor (Optional)</b> .....	<b>6</b>
<b>Replace Fuses for Solar Connector to Alligator Clips Cable</b> .....	<b>7</b>
<b>Solar Suitcase Expansion</b> .....	<b>8</b>
Expansion for 12V Systems .....	8
Expansion for 24V Systems .....	9
<b>Operation</b> .....	<b>10</b>
Power On/Off .....	10
LCD Screen .....	10
Setting Buttons .....	11
<b>Configuration</b> .....	<b>11</b>
Set Battery Type .....	11
Reset Power Generation .....	13
Modify Temperature Unit .....	13
<b>Charging Logic</b> .....	<b>13</b>
PWM Technology.....	13
Adaptive Four-Stage Charging .....	14
Activate Lithium Batteries .....	15
<b>Troubleshooting</b> .....	<b>15</b>
<b>Technical Specifications</b> .....	<b>17</b>
<b>Frequently Asked Questions</b> .....	<b>18</b>
<b>Maintenance &amp; Storage</b> .....	<b>18</b>
<b>Important Safety Instructions</b> .....	<b>18</b>
<b>Renogy Support</b> .....	<b>20</b>

## Symbols Used

The following symbols are used throughout the user manual to highlight important information.

-  **WARNING:** Indicates a potentially dangerous condition which could result in injury or death.
-  **CAUTION:** Indicates a critical procedure for safe and proper installation and operation.
-  **NOTE:** Indicates an important step or tip for optimal performance.

## Introduction

Monocrystalline Foldable Solar Suitcase with Voyager comes with two highly efficient monocrystalline solar panels, a 20A Voyager charge controller, and a solar connector to clip cable. Featuring easy-to-use and plug-and-play design, the suitcase is specifically designed for mobile off-grid applications, where space and weight limitations are abundant. The suitcase supports 12V or 24V deep-cycle gel-sealed lead-acid batteries (GEL), flooded lead-acid batteries (FLD), sealed lead-acid batteries (SLD/AGM) or lithium iron phosphate batteries (LI).

With built-in tilting stands, these panels can be adjusted at different angles to maximize the power output throughout the seasons.

The alligator clips included in this package make it easy to connect the panels to nearly all kinds of battery terminals in seconds.

## Key Features

- **Battery Compatibility:** Supports four battery types - GEL, FLD, SLD/AGM, and LI.
- **Backlit LCD:** Displays system operating information and error codes for easy monitoring on the built-in LCD.
- **Waterproof Design:** Suitable for both indoor and outdoor use.
- **Four-Stage PWM Charging:** Includes Bulk, Absorption, Float, and Equalization stages.
- **Comprehensive Protections:** Offers multiple battery, controller, and PV electronic protections.
- **Smart PWM Technology:** High efficiency with an activating feature for lithium batteries.
- **Low-Light Performance:** Excellent efficiency even in low-light environments.
- **Adjustable Stand:** Corrosion-resistant aluminum stand for maximum solar light capture.
- **Easy Setup:** Includes alligator clips for simple connection of the Voyager charge controller to your battery, ideal for mobile systems seeking flexibility.

## SKU

RENOGY 100W Solar Suitcase with 20A Voyager	RNG-KIT-STCS100D-VOY20
RENOGY 200W Solar Suitcase with 20A Voyager	RNG-KIT-STCS200D-VOY20

## What's In the Box?

RENOGY 100W/200W Solar Suitcase x 1



User Manual x 1



Solar Connector to Alligator  
Clips Cable w/ 15A Fuse x 1  
(10 feet / 3 m) (14 AWG)



Voyager 20A PWM  
Solar Charge Controller  
(Pre-installed to Solar Panels) x 1



- i** Make sure that all accessories are complete and free of any signs of damage.
- i** The accessories and product manual listed are crucial for the installation, excluding warranty information and any additional items. Please note that the package contents may vary depending on the specific product model.

## Get to Know Renogy Solar Suitcase with Voyager

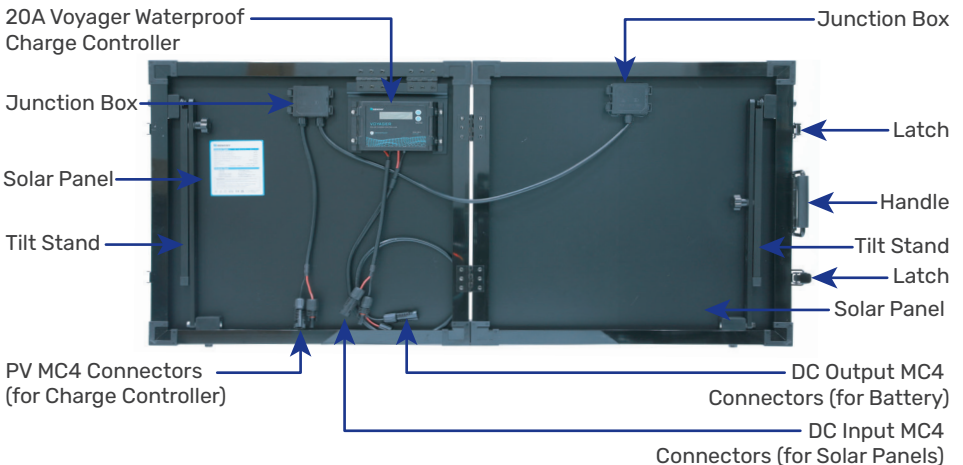

**i** Depending on the country and region, you may receive a product where the internal controller is already connected to the solar suitcase. In this case, it is recommended that you block sunlight from the front of the solar suitcase before connecting the battery to the system.

## Dimensions

**i** Dimension tolerance:  $\pm 0.2$  in (0.5 mm)

### RENOGY 100W Solar Suitcase with 20A Voyager

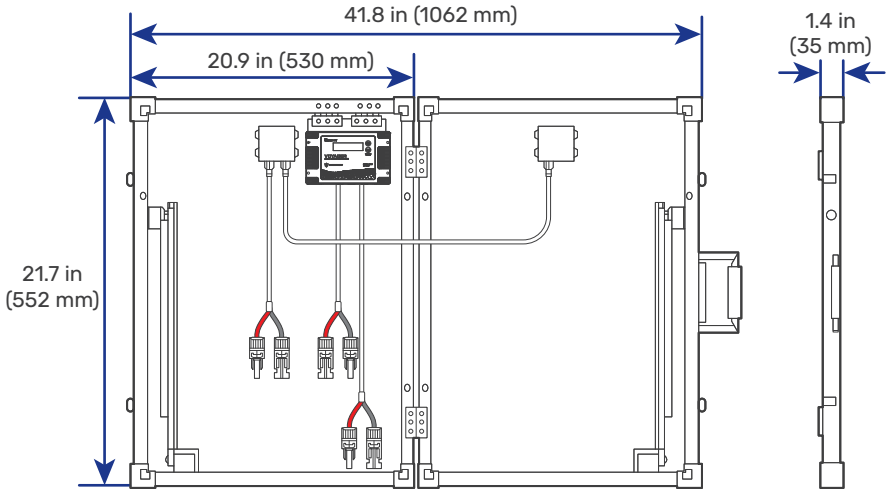

### RENOGY 200W Solar Suitcase with 20A Voyager

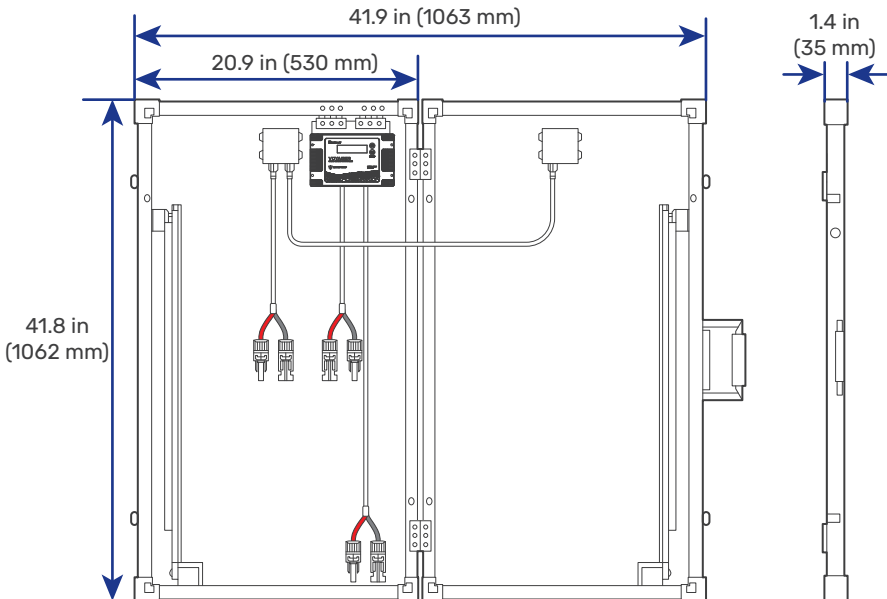

## System Setup

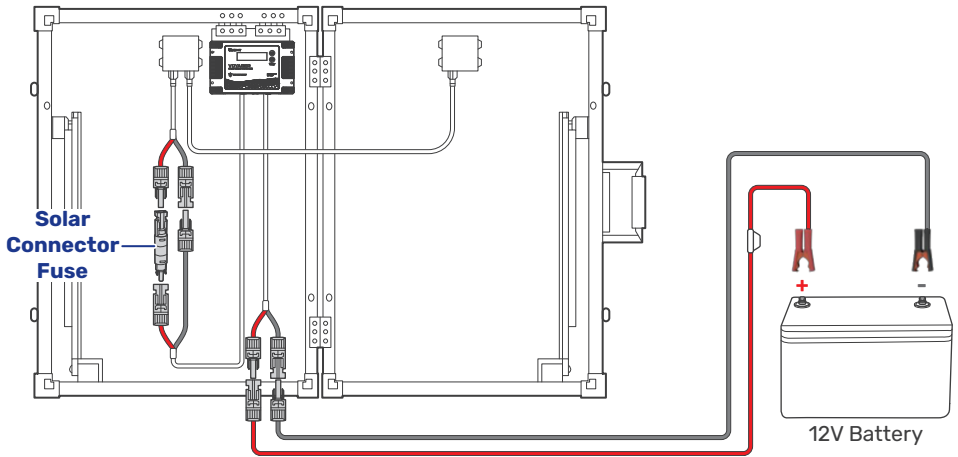

- i** The solar suitcase supports 12V battery systems only when working alone. You can connect the solar suitcase to 24V battery systems by expanding the solar panels. For details, see "[Solar Suitcase Expansion](#)".
- i** A solar connector fuse is required to protect your solar suitcase from overcurrent. You can purchase a proper solar connector fuse at [www.renogy.com](http://www.renogy.com).

## Step 1. Unfold and Install the Solar Panels

To ensure safe, efficient system operation, always follow the installation instructions in the order depicted in the manual.

The solar suitcase comes with a rugged protective case that protects the suitcase during storage and transportation.

Inspect the solar suitcase for any visible damage including cracks, dents, deformation, and other visible abnormalities. All connector contacts shall be clean, dry, and free of dirt and corrosion.

**⚠** Do not use the solar suitcase if there is any visible damage.

**Step 1:** Take the suitcase out of the protective case.

**Step 2:** Wear insulating gloves, and unlatch and unfold unit.

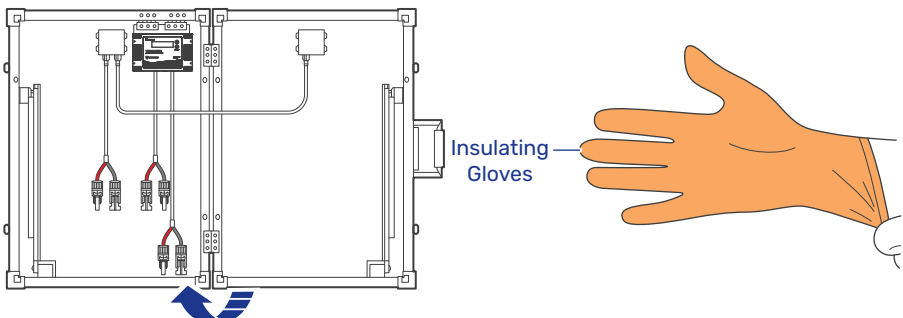

**Step 3:** Unscrew the butterfly nuts on the tilt strands to a desired angle, and lock the butterfly nuts.

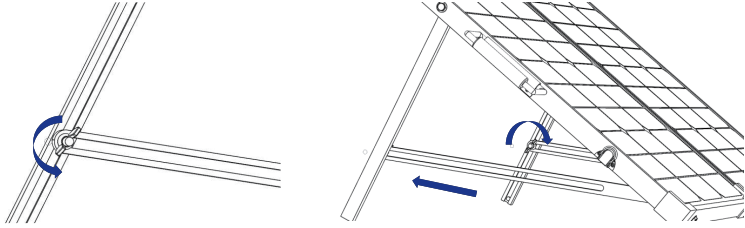

**Step 4:** To maximize the output, adjust the angle of the suitcase regularly to track the sun's movement throughout the season. For detailed instructions on how to determine the angle and orientation of solar panels, visit [How to Find the Best Orientation and Angle of Solar Panels?](#) at Renogy Learning Center.

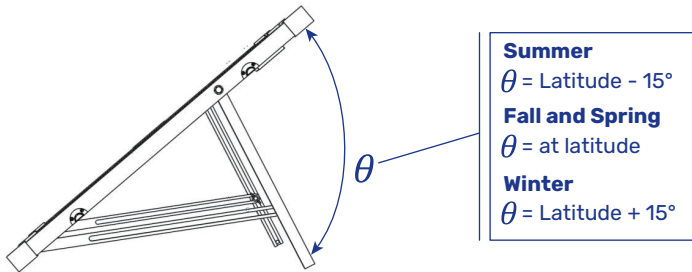

## Step 2. Connect the Voyager Charger Controller to a Battery

A Monocrystalline Foldable Solar Suitcase with Voyager can be connected to 12V deep-cycle gel-sealed lead-acid batteries (GEL), flooded lead-acid batteries (FLD), sealed lead-acid batteries (SLD/AGM), or lithium iron phosphate batteries (LI) only. For how to connect the suitcase to 24V battery systems, see ["Solar Suitcase Expansion"](#).

**Step 1:** Connect the included Solar Connector to Alligator Clips Cable w/ 15A Fuse to the DC Output MC4 Connectors on the Voyager charge controller.

**Step 2:** Attach the negative alligator clip (in black) to the negative terminal of your battery.

**Step 3:** Attach the positive alligator clip (in red) to the positive terminal of your battery.

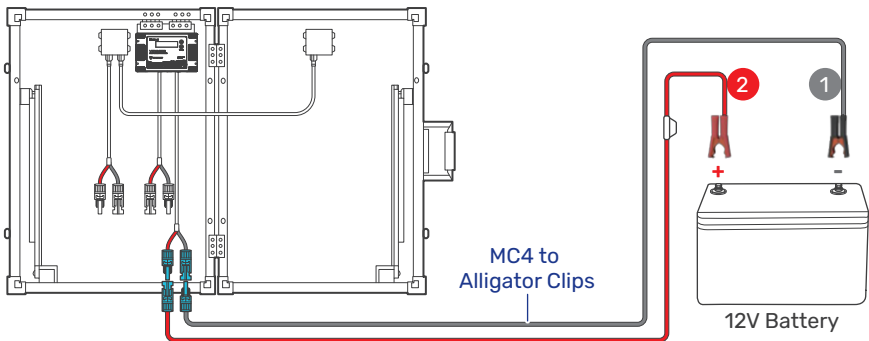



## Step 3. Connect the Solar Panels to the Voyager

**Step 1:** Connect the negative end (male) of the DC Input MC4 Connectors on the Voyager charge controller to the female end of the PV MC4 Connectors on the solar panels.

**Step 2:** Connect the positive end (female) of the DC Input MC4 Connectors on the Voyager charge controller to a solar connector fuse (10A for a 100W solar suitcase, 15A for a 200W solar suitcase) and connect the fuse to the male end of the PV MC4 Connectors on the solar panels.

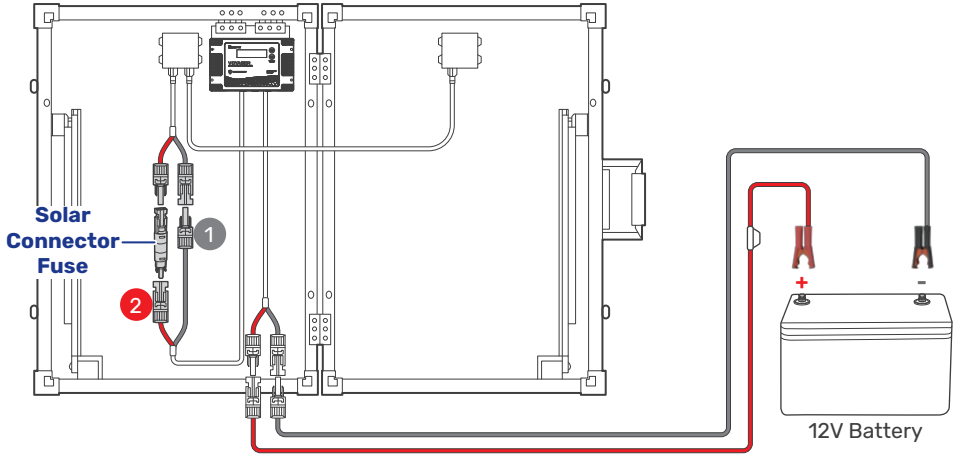

**i** You can purchase a proper solar connector fuse at [renogy.com](https://www.renogy.com).

## Step 4. Install a Battery Temperature Sensor (Optional)

You can install a battery temperature sensor on the Voyager charge controller. The temperature sensor measures the surrounding temperature of the battery and compensates the floating charge voltage when the battery temperature is low.

### Recommended Accessories

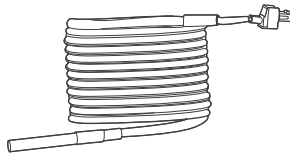

\*Renogy Battery Temperature Sensor

**i** Accessories marked with "\*" are available on [renogy.com](https://www.renogy.com).

**⚠** Do not use the temperature sensor on a LiFePO4 (LFP) battery which comes with a battery management system (BMS).

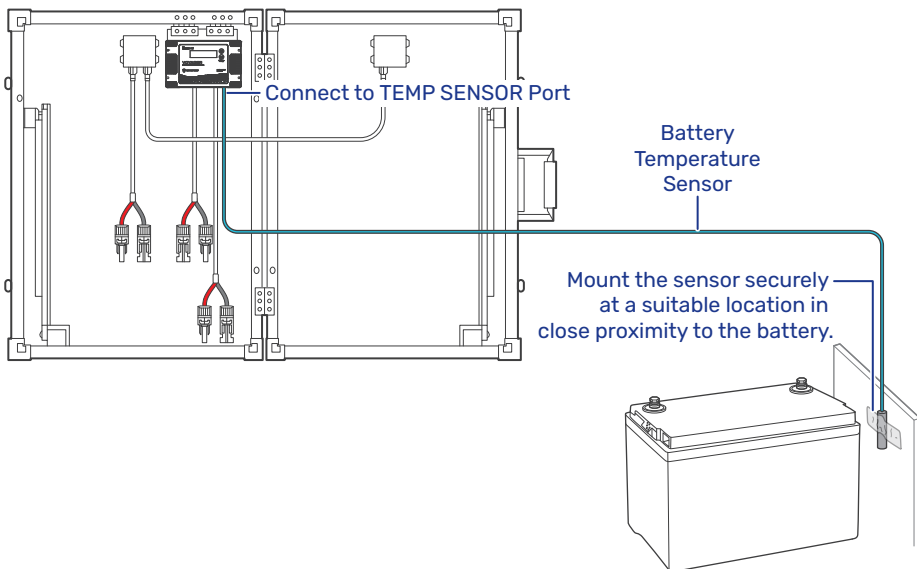

## Replace Fuses for Solar Connector to Alligator Clips Cable

The integrated 15A fuse in the Solar Connector to Alligator Clips Cable blows out when the charging current is higher than 15A. Replace the blown-out fuse by following the instructions below:

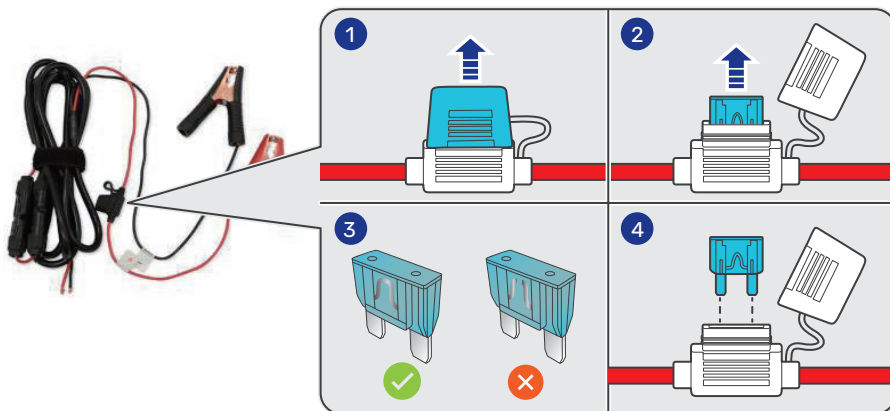

## Solar Suitcase Expansion

You can expand the solar suitcase to make it compatible with 24V systems or increase the power generation capacity for the whole system by using additional solar panels of the same model. The required products are listed below:

Solar Suitcase Model	Solar Panel Model
Renogy 100W Solar Suitcase with 20A Voyager (RNG-KIT-STCS100D-VOY20)	Renogy 100W 12V Foldable Solar Suitcase (RNG-KIT-STCS100D-NC)
Renogy 200W Solar Suitcase with 20A Voyager (RNG-KIT-STCS200D-VOY20)	Renogy 200W 12V Foldable Solar Suitcase (RNG-KIT-STCS200D-NC)



Using solar panels of different models or brands may damage the Voyager charge controller, thus voiding the warranty.

### Expansion for 12V Systems

- For a 100W solar suitcase, you can expand RNG-KIT-STCS100D-VOY20 to achieve 20.4V at solar output power of 200W by connecting the suitcase to a 100W 12V Foldable Solar Suitcase (RNG-KIT-STCS100D-NC) in parallel.
- For a 200W solar suitcase, direct parallel connection of solar panels is not permitted. However, parallel expansion can be achieved by replacing the included Voyager 20A charge controller with a compatible model. Refer to the user manual of the new charge controller for specific instructions, or contact the manufacturer for further guidance.

### Recommended Accessories

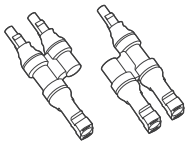

\*Solar Branch Connector (MMF + FFM Pair)



\*Adapter Kit (14 AWG)

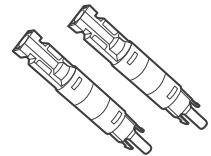

\*Solar Connector Fuse (10A)



Accessories marked with "\*" are available on [renogy.com](https://www.renogy.com).

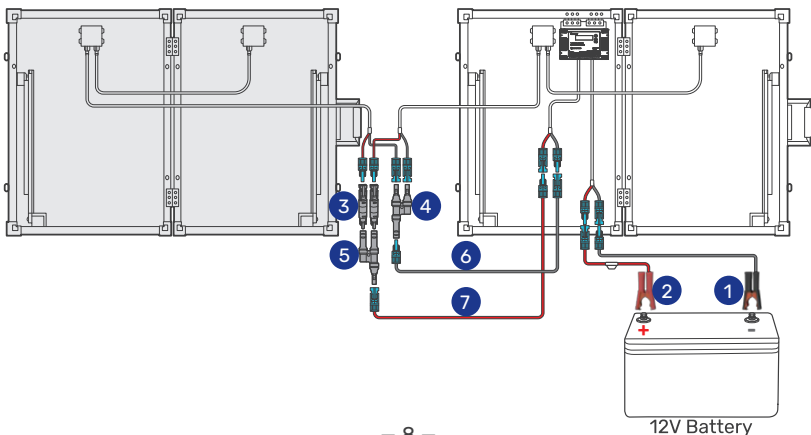

## Expansion for 24V Systems

- For a 100W solar suitcase, you can expand it to achieve 40.8V at solar output power 400W of by connecting the suitcase to three 100W 12V Foldable Solar Suitcases (RNG-KIT-STCS100D-NC) in series-parallel (each two in series, and then in parallel).
- For a 200W solar suitcase, you can expand it to achieve 40.8V at solar output power of 400W by connecting the suitcase to a 200W 12V Foldable Solar Suitcase (RNG-KIT-STCS200D-NC) in series.

### Recommended Accessories

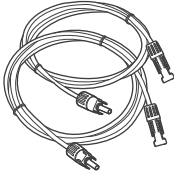

\*Adapter Kit (14 AWG)

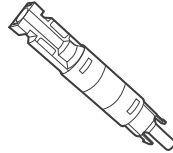

\*Solar Connector Fuse (15A)

 Accessories marked with "\*" are available on [renogy.com](https://www.renogy.com).

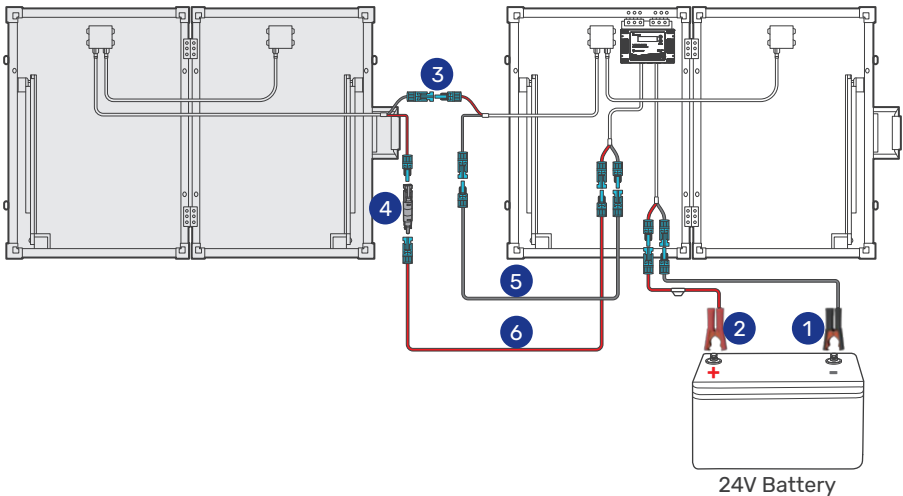

# Operation

## Power On/Off

The Voyager charge controller automatically turns on when it is connected to a battery. To power it off, disconnect the solar panels from the charge controller, followed by the battery.

## LCD Screen

The charge controller provides an intuitive LCD screen that automatically cycles through the following Main Interfaces:

- PV Array Voltage: the output voltage of solar panels.
- Charging Current: the charging current from solar panels.
- Generated Energy: the total energy generated by the connected solar panels.
- Battery Voltage: the nominal battery voltage and boost charging voltage of the connected battery.
- Battery Temperature: the actual temperature of the connected battery.

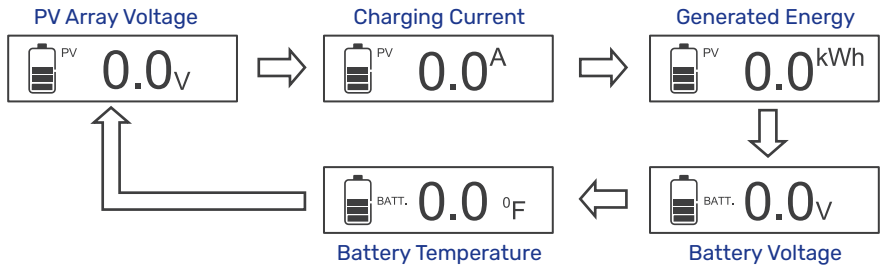



The system icons have different indications as illustrated in the table below:

Icon	Status	Indication
	Static	The system is in normal operation and the battery is not being charged.
	Blinking (with the first two missing progress bars blinking from the bottom to top)	The battery is being charged.
	Static	The battery is at full charge..
	Blinking	The battery is overvoltage.
	Blinking	The battery is undervoltage
	Blinking (with the progress bars blinking in sequence from left to right)	The Voyager charge controller is activating the over-discharged lithium battery.
	Static	System error. For details, see " <a href="#">Troubleshooting</a> " in the manual.

## Setting Buttons

The Voyager charge controller provides two easy-to-use setting buttons, allowing you to check and adjust relative parameters on demand.

Icon	Operation	Function
	Single press	<ul style="list-style-type: none"> <li>In the Main Interface: Cycle forwards through different display interfaces.</li> <li>In the Battery Voltage Interface: Cycle through different parameter values.</li> </ul>
	Single press	<ul style="list-style-type: none"> <li>In the Main Interface: Cycle backwards through different display interfaces.</li> <li>In the Battery Voltage Interface: Enter boost battery voltage settings.</li> </ul>
	Press and hold	<ul style="list-style-type: none"> <li>Enter a Parameter Setting Interface.</li> <li>Confirm and save parameter settings*</li> </ul>

\*The setting will also be automatically saved 15 seconds after when there is no pressing and holding on the **BATTERY TYPE** button.

## Configuration

### Set Battery Type

To ensure safe, efficient, and effective charging, you need to manually set the type of the connected battery on the Voyager charge controller.

 Incorrect battery type setting may damage your battery. Please check your battery manufacturer's specifications to when selecting battery type.





**Step 1:** In the Main Interface, press the **AMP/VOLT** button to navigate to the Battery Voltage interface.

**Step 2:** In the Battery Voltage interface, press and hold the **BATTERY TYPE** button for approximately three seconds until the current battery type flashes.



 For lithium batteries, setting the nominal battery voltage is required. For details, see [“Set Nominal and Boost Voltage for Lithium Batteries”](#) in the manual.

**Step 3:** Press the **AMP/VOLT** button to select the type of your connected battery. Supported battery types include SLD/AGM, gel, flooded, and lithium.

SLD/AGM	GEL	FLD	LI
 BATT. TYPE SEL	 BATT. TYPE GEL	 BATT. TYPE FLD	 BATT. TYPE LI

**Step 4:** After selecting a correct battery type, press and hold the **BATTERY TYPE** button to save the settings.

## Set Nominal and Boost Voltage for Lithium Batteries

### ■ Setting Instructions

The Voyager charge controller automatically detects 12V and 24V nominal voltages for non-lithium batteries once you set the correct battery type. For lithium batteries, manual setting of the nominal voltage is required.

**Step 1:** In the Main Interface, press the **AMP/VOLT** button to navigate to the Battery Voltage interface.

**Step 2:** In the Battery Voltage interface, press and hold the **BATTERY TYPE** button for approximately three seconds until the battery type icon flashes.

**Step 3:** Press the **BATTERY TYPE** button to set the type of your connected battery to LI. The LI parameter flashes, and press the **BATTERY TYPE** button to enter the setting interface of nominal battery voltage.



**Step 4:** When the 12V icon flashes, press the **AMP/VOLT** button to choose between 12V and 24V voltages based on the nominal voltage of your connected battery. Once you confirm your nominal voltage, press and hold the **BATTERY TYPE** button to move to Boost Voltage.



**Step 5:** Press the AMP/VOLT button to set the Boost Voltage. By default, the Boost Voltage is set to 14.2V. The allowed range: 12V to 16V in 0.2V increments.



**i** The LCD screen illustrations in this section are based on 12V systems. For 24V systems, the charge controller automatically doubles the parameter values while remaining the display value as 12V systems.

**Step 6:** After selecting a correct nominal voltage, press and hold the BATTERY TYPE button to save the settings.

### ■ Recommended Charging Parameters

The table below illustrates the default and recommended parameters for batteries that can be connected to the charge controller. The parameters may vary depending on the specific battery you use. Read the user manual of the specific battery or contact the battery manufacturer for help if necessary.

**⚠** Before modifying battery parameters, check the table below first. Incorrect parameter setting will damage the device and void the warranty.

**⚠** Read the user manual of the battery when customizing a preset battery. Incorrect battery type selection damages the charge controller and voids the warranty.

The parameters listed in the table below apply to 12V batteries. For 24V batteries, the charge controller automatically doubles the parameter values while remaining the display value as 12V systems.

Parameter	Gel	SLD/AGM	Flooded	Lithium
High Voltage Disconnect			16V	
Charging Voltage Limit			15.5V	

Parameter	Gel	SLD/AGM	Flooded	Lithium
<b>Overvoltage Reconnect</b>	15.0V			
<b>Equalizing Voltage</b>	-	14.6V	14.8V	-
<b>Boost Voltage</b>	14.2V	14.4V	14.6V	14.2V (User-defined: 12V to 16V)
<b>Float Voltage</b>	13.8V	13.8V	13.8V	-
<b>Boost Return Voltage</b>	13.2V			
<b>Low Voltage Disconnect</b>	11.1V			
<b>Low Voltage Reconnect</b>	12.6V			
<b>Undervoltage Warning</b>	12.0V			
<b>Undervoltage Recover</b>	12.2V			
<b>Discharging Voltage Limit</b>	10.8V			
<b>Equalization Duration</b>	-	2 hours	2 hours	-
<b>Low Voltage Reconnect</b>	2 hours	2 hours	2 hours	-

## Reset Power Generation

You can reset the solar energy generation data to 0 kWh on the Voyager charge controller.

**Step 1:** In the Main Interface, press the **AMP/VOLT** button to navigate to the Generated Energy interface.

**Step 2:** In the Generated Energy interface, press the **AMP/VOLT** button to reset the power generation data to zero.



## Modify Temperature Unit

You can modify the battery temperature unit that is displayed on the Voyager charge controller.

**Step 1:** In the Main Interface, press the **AMP/VOLT** button to navigate to the Battery Temperature interface.

**Step 2:** In the Battery Temperature interface, press and hold the **BATTERY TYPE** button for approximately three seconds to switch between the Celsius and Fahrenheit.



## Charging Logic

### PWM Technology

The included Voyager charge controller utilizes the Pulse Width Modulation (PWM) technology for battery charging.

Battery charging is a current-based process so controlling the current will control the battery voltage.

For the most accurate return of capacity and to prevent excessive gassing pressure, the battery



is required to be controlled by specified voltage regulation set points for Absorption, Float, and Equalization charging stages. The Voyager charge controller uses automatic duty cycle conversion, creating pulses of current to charge the battery. The duty cycle is proportional to the difference between the sensed battery voltage and the specified voltage regulation set point. Once the battery reached the specified voltage range, pulse current charging mode allows the battery to react and allows for an acceptable rate of charge for the battery level.

### Adaptive Four-Stage Charging

Charge controller has a four-stage battery charging algorithm for a rapid, efficient, and safe battery charging. The stages include: Bulk Charging, Boost Charging, Float Charging, and Equalization.

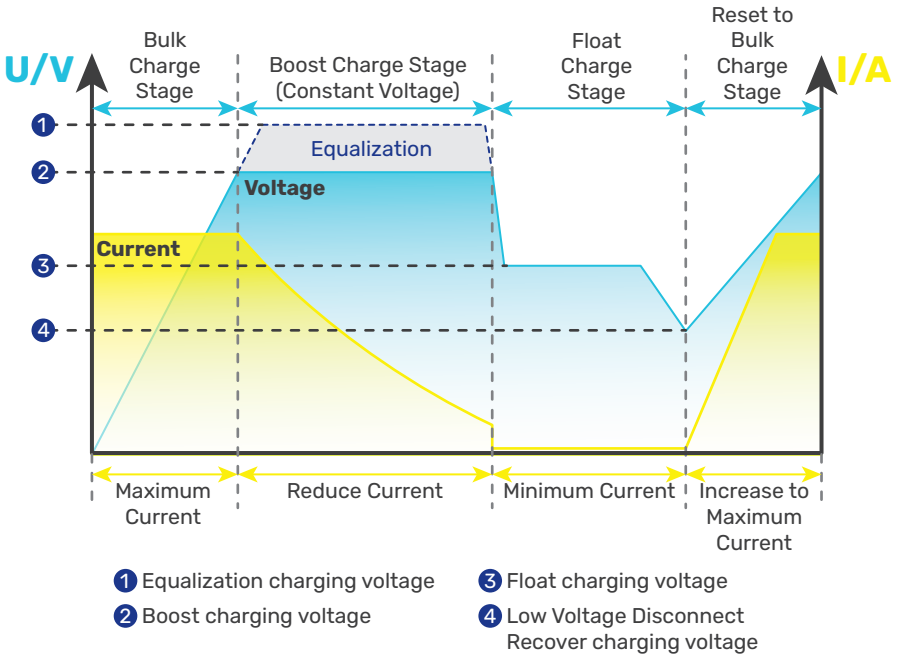

**i** Adjust the time depending on the specific battery bank size.

#### Bulk Charge Stage

The charge controller will supply constant current until the battery voltage reaches the boost voltage. It uses 100% of available solar power to recharge the battery.

#### Boost Charge

The charge controller will supply constant voltage and reduce the current slowly through this stage. Default boost duration: 2 hours. After this time, the charger will enter the float stage.

- i** Boost Duration is not applicable to lithium batteries.
- i** The stage is determined by internal software in the charge controller.

#### Float Charge Stage



During this stage the charge controller will supply a constant voltage which is determined by the battery selected and will keep current at a minimum level. This stage acts as a trickle charger. After reaching a constant voltage in the charging process, the charge controller reduces

the voltage to a float level. At this point, the battery is fully charged, and any excess current is converted to heat or gas. The charger then maintains a lower voltage to offset power consumption, ensuring a full battery capacity. If a load exceeds the charge current, the charger exits float mode and returns to bulk charging.

 Float charging is not applicable to lithium batteries.

## Equalization

This stage is only available for batteries with equalization, such as non-sealed, vented, flooded, and wet cell lead acid batteries. During this stage the batteries are charged at a higher voltage than normal and for most batteries this could cause damage. Refer to the user manual of the battery or contact the battery manufacturer to see if this stage is needed.

-  During Equalization charging, the charge controller remains in this stage until sufficient charging current is sourced from the solar panel. Note that there should be no load on the batteries during Equalization charging.
-  Overcharging and excessive gas precipitation can harm battery plates, leading to material shedding. Carefully review the battery's specific requirements to avoid damage from prolonged or excessively high Equalization charging.
-  Equalization may elevate battery voltage to levels that could damage sensitive DC loads. Ensure that the allowable input voltages of all loads exceed the set voltage during Equalization charging.

## Activate Lithium Batteries

The Voyager charge controller has a reactivation feature to awaken a sleeping lithium battery. The protection circuit of lithium battery will typically turn the battery off and make it unusable if the battery is overdischarged. This can happen when storing a lithium battery in a discharged state for any length of time as self-discharge would gradually deplete the remaining charge. Without the activation feature to activate and charge batteries, these batteries would become unserviceable and the packs would be discarded. The Voyager charge controller applies a small charge current to activate the protection circuit and if a correct cell voltage can be reached, it starts a normal charge. By default, the charge controller enables the lithium battery activation function when the battery type is set to LI.

-  For 24V lithium batteries, set the nominal voltage to 24V on the Voyager charge controller. Otherwise, the overdischarged 24V lithium battery will not be activated.



## Troubleshooting

The included Voyager charge controller presents error code to help you quickly locate the fault and find a solution. The error code automatically disappears when the error is resolved.

Error Code	Description
E00	No error detected
E01	Battery overdischarged
E02	Battery overvoltage
E06	Charge controller overtemperature
E07	Battery overtemperature
E08	Solar input overcurrent

E10	Solar overvoltage
E13	Solar reverse polarity
E14	Battery reverse polarity
E15	No battery detected

In addition to error code, the charge controller reports battery overvoltage and undervoltage errors through the battery icon on the built-in LCD.

Battery Icon	Description	Troubleshoot
 (Blinking)	Battery overvoltage	<ol style="list-style-type: none"> <li>1. Use a multimeter to check the battery voltage. Ensure the battery voltage does not exceed the rated specification of the charge controller (16V for 12V systems and 32V for 24V systems).</li> <li>2. If the voltage is too high, disconnect the battery from the charge controller.</li> </ol>
 (Blinking)	Battery undervoltage	<ol style="list-style-type: none"> <li>1. Use a multimeter to verify the battery voltage. The 12V triggers an undervoltage warning and 11.1V triggers low voltage disconnect for 12V systems. For 24V systems, double the values respectively.</li> <li>2. Disconnect any loads connected to the battery to allow proper battery charging.</li> </ol>
N/A	Charge controller not working during daytime	<ol style="list-style-type: none"> <li>1. Confirm that the connections from the battery to the charge controller and from the solar panels to the charge controller are tight and correct.</li> <li>2. Use a multimeter to check if the polarities of the solar panels have been reversed on the charge controller's solar terminals. A reversed polarity is indicated by a negative voltage reading on the multimeter.</li> </ol>
N/A	Charge controller LCD not on	Check the actual battery voltage. The LCD on the charge controller will not display unless there is at least 9V for 12V systems or 18V for 24V systems coming from the battery.

 For further assistance, contact Renogy technical support service at [renogy.com/contact-us](https://www.renogy.com/contact-us).

## Technical Specifications

Solar Panel		
Item	100W Model (RNG-KIT-STCS100D-NC)	200W Model (RNG-KIT-STCS200D-NC)
Maximum Power at STC	100W	200W
Open Circuit Voltage (Voc)	24.3V	
Short Circuit Current (Isc)	5.45A	10.42A
Maximum Power Voltage (Vmp)	20.4V	
Maximum Power Current (Imp)	4.91A	9.82A
Cell Type	Monocrystalline	
Operating Temperature	-40°F to 185°F (-40°C to 85°C)	
Folded Size	21.7 x 20.9 x 2.8 in (552 x 530 x 71 mm)	41.8 x 20.9 x 2.8 in (1062 x 530 x 71 mm)
Net Weight	21.2 lbs (9.6 kg)	34.4 lbs (15.6 kg)
Charge Controller		
Model	VOYP20	
System Voltage	12V/24V (Auto detection for non-lithium)	
Battery Rated Current	20A	
Max Battery Voltage	32V	
PV Input Voltage Range	15V to 55V	
Max PV Input (Voc)	12V@25V; 24V@55V	
PV Power Input	12V@260W; 24V@520W	
Power Consumption	12V@0.24W; 24V@0.74W	
Battery Type	SLD/AGM, GEL, FLD and LI	
Electronic Protections	Battery overtemperature, charge controller overtemperature, solar reverse polarity, battery reverse polarity, battery overvoltage, and solar input overcurrent	
Grounding Type	Positive	
Controller Terminals	20-6 AWG, 2-pin terminals	
Temperature Compensation	-3mV / °C / 2V, excludes LI	
Operating Temperature	-31°F to 113°F (-35°C to 45°C)	
Storage Temperature	-31°F to 167°F (-35°C to 75°C)	
Operating / Storage Humidity	10% to 90%, No condensation	
IP Rating	IP67	

<b>Dimensions</b>	6.08 x 3.83 x 1.40 in (154 x 97 x 36 mm)
<b>Weight</b>	0.55 lbs (0.25 kg)
<b>Certification</b>	ETL and CE

## Frequently Asked Questions

### ■ Can the solar suitcase charge two or more 12V or 24V batteries connected in parallel?

Yes. It is possible the batteries have the same type and capacity and are wired in parallel. For details, see the user manual of the specific battery. You can also refer to "[Series, Parallel, and Series-Parallel Connections of Batteries](#)" at [renogy.com/learning-center](http://renogy.com/learning-center).

### ■ Is there any risk that the solar suitcase will over charge my battery?

The included Voyager charge controller provides an overcharge protection function to mitigate the overcharge risks.

### ■ Can I extend the solar connector to alligator clips cable?

Yes. The included solar connector to alligator clips cable is 10 feet (3m) long, suitable for most applications. For longer battery cables, use the same size cable, ensuring it can handle the maximum current from the solar panels (10A for a 100W solar suitcase, 15A for a 200W solar suitcase). Refer to "[Sizing Wires for PV Systems](#)" at [renogy.com/learning-center](http://renogy.com/learning-center) for details. Note that longer extensions increase line loss, requiring a larger gauge for longer runs.

### ■ Do I need to clean the included solar panels?

Yes, solar panel cleaning is recommended for better performance. Dust and dirt should first be swept off the panel surface using a soft brush. When the sweeping is complete, use a wet cloth to wipe the panel surface to remove remaining dirt and grime. For details, refer to "[How to Clean and Maintain Solar Panels?](#)" at [renogy.com/learning-center](http://renogy.com/learning-center).

### ■ Can rain damage the solar suitcase?

No. Both the included solar panels and charge controller are waterproof with ratings of IP65 and IP67, respectively.

## Maintenance & Storage

For best controller performance, it is recommended that these tasks be performed from time to time.

1. Check wiring going into the charge controller and make sure there is no wire damage or wear.
2. Tighten all terminals and inspect any loose, broken, or burnt up connections.
3. Occasionally clean the case using a damp cloth.

## Important Safety Instructions

### General

- Wear proper protective equipment and use insulated tools during device installation and operation. Do not wear metal objects when working on or around the solar suitcase.
- Keep the solar suitcase out of the reach of children.
- Do not dispose of the solar suitcase as household waste. Comply with local, state, and federal laws and regulations and use recycling channels as required.
- In case of fire, put out the fire with a FM-200 or CO<sub>2</sub> fire extinguisher.
- Do not expose the solar suitcase to flammable or harsh chemicals or vapors.
- Clean the solar suitcase regularly.

- It is recommended that all cables should not exceed 10 meters because excessively long cables result in a voltage drop.
- The cable specifications listed in the user manual account for critical, less than 3% voltage drop and may not account for all configurations.
- Do not expose the solar suitcase to strong electrostatic fields, strong magnetic fields, or radiation.

## **Solar Suitcase Safety**

- Do not use sharp objects to wipe or scratch the solar suitcase surfaces.
- Do not install the solar suitcase on a surface constructed from combustible material.
- Do not expose the solar suitcase to direct flame or heat sources.
- Keep the solar suitcase away from explosives and corrosive substances.
- Do not step, walk, stand, or jump on the solar suitcase. Localized heavy loads may cause damage to the solar cells, which will ultimately compromise the performance of the solar suitcase.
- Do not bend the solar suitcase. Bending the solar suitcase will cause damage to the cells and affect panel performance.
- Do not immerse the solar suitcase in water.
- Do not connect the solar suitcase directly to a battery.
- Cover the solar suitcase prior to connecting it to the charge controller.
- Identify the polarities (positive and negative) on the cables used for solar suitcases. A reverse polarity contact may damage the unit.
- Always connect the charge controller to the battery prior to the solar suitcase to avoid damage on the charge controller caused by open-circuit voltage from the suitcase.

## **Battery Safety**

- Avoid short-circuiting the battery terminals to prevent irreversible damage to the system and battery caused by current bursts.
- Verify polarity before wiring to avoid irreversible battery damage due to polarity reversal.
- Please keep the battery away from water, heat sources, sparks, and hazardous chemicals.
- Do not puncture, drop, crush, burn, penetrate, shake, strike, or step on the battery.
- Do not open, dismantle, repair, tamper with, or modify the battery.
- Do not touch any terminals or connectors.
- Please make sure any battery charger or charge controller has been disconnected before working on the battery.
- Do not connect or disconnect terminals from the battery without first disconnecting loads.
- Do not place tools on top of the battery.
- Please use suitable handling equipment for safe transportation of the battery.
- Do not insert foreign objects into the positive and negative terminals of the battery.
- Do not touch the exposed electrolyte or powder if the battery is damaged.
- If uncovered electrolyte or powder contacts your skin or eyes, flush it out immediately with plenty of clean water and seek medical attention.

# Renogy Support

To discuss inaccuracies or omissions in this quick guide or user manual, visit or contact us at:

[G | renogy.com/support/downloads](https://renogy.com/support/downloads)

 [contentservice@renogy.com](mailto:contentservice@renogy.com)

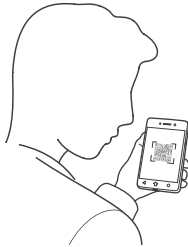

Questionnaire Investigation



To explore more possibilities of solar systems, visit Renogy Learning Center at:

[G | renogy.com/learning-center](https://renogy.com/learning-center)

For technical questions about your product in the U.S., contact the Renogy technical support team through:

[G | renogy.com/contact-us](https://renogy.com/contact-us)

 1(909)2877111

For technical support outside the U.S., visit the local website below:

**Canada** |  | [ca.renogy.com](https://ca.renogy.com)

**China** |  | [www.renogy.cn](https://www.renogy.cn)

**Australia** |  | [au.renogy.com](https://au.renogy.com)

**Japan** |  | [jp.renogy.com](https://jp.renogy.com)

**South Korea** |  | [kr.renogy.com](https://kr.renogy.com)

**Germany** |  | [de.renogy.com](https://de.renogy.com)

**United Kingdom** |  | [uk.renogy.com](https://uk.renogy.com)

**Other Europe** |  | [eu.renogy.com](https://eu.renogy.com)



## Renogy Empowered

Renogy aims to empower people around the world through education and distribution of DIY-friendly renewable energy solutions.

We intend to be a driving force for sustainable living and energy independence.

In support of this effort, our range of solar products makes it possible for you to minimize your carbon footprint by reducing the need for grid power.



## Live Sustainably with Renogy

Did you know? In a given month, a 1 kW solar energy system will...



Save 170 pounds of coal from being burned



Save 300 pounds of CO<sub>2</sub> from being released into the atmosphere



Save 105 gallons of water from being consumed



## Renogy Power PLUS

Renogy Power Plus allows you to stay in the loop with upcoming solar energy innovations, share your experiences with your solar energy journey, and connect with like-minded people who are changing the world in the Renogy Power Plus community.



@Renogy Solar



@renogyofficial



@Renogy

Renogy reserves the right to change the contents of this manual without notice.

Manufacturer: RENOGY New Energy Co.,Ltd  
Address: No.66, East Ningbo Road Room 624-625 Taicang German  
Overseas Students Pioneer Park JiangSu 215000 CN



eVatmaster Consulting GmbH  
Battinatr. 30  
60325 Frankfurt am Main, Germany  
contact@evatmaster.com



Manufacturer: RENOGY New Energy Co.,Ltd  
Address: No.66, East Ningbo Road Room 624-625 Taicang German  
Overseas Students Pioneer Park JiangSu 215000 CN



EVATOST CONSULTING LTD  
Office 101 32 Threadneedle Street,  
London, United Kingdom, EC2R 8AY  
contact@evatost.com

