

PARMCO

INSTALLATION AND OPERATING INSTRUCTIONS

Model: WM10WF02

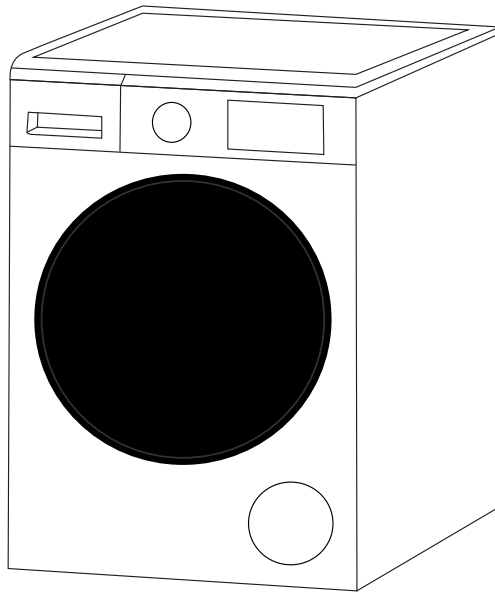

As part of Parmco Appliances commitment to improving and updating product ranges, we reserve the right to alter, change and update technical specifications and appearance attributes of all Parmco Appliances products. E&OE.



Dear Valued Customer,

Thank you and congratulations on purchasing your new Parmco appliance. All Parmco products are made to the highest quality and design standards. We are sure you will enjoy your new appliance.

As a note, please read through these instructions carefully. These will assist you in gaining a complete understanding of the functions and features offered by your appliance. Please take special note of all detailed technical information and installation instructions. It is essential that you follow these instructions to ensure the safety and reliability of this appliance.

Furthermore, not using appropriate personnel to install this appliance may affect any future warranty claims lodged, so please check with Parmco Appliances before any installation is carried out.

We hope you enjoy your new appliance. If you would like to find out more about this product or any other products in Parmco's extensive range, visit us online at www.parmco.co.nz.

Regards,
The Parmco Team

PARMCO

Inspiring kitchens, entertaining homes

Parmco Appliances extended 7 year warranty



The Warranty:

- This appliance is intended for domestic use in the owners' home. Use of the appliance for commercial purposes will limit the warranty period (please see Parmco website for commercial details).
- Subject to the terms and conditions contained within this warranty, if the product is not of Acceptable Quality (as defined in the Consumer Guarantees Act) within 7 years of the date of original purchase, then Parmco Sales undertakes to repair or, at its sole discretion, replace the product.
- The warranty does not cover the costs of transport, mileage or travelling time if the product is located beyond 30km of a recognised Service Agent.
- This warranty is offered as an extra benefit, and does not affect other legal rights, which can not be modified or excluded by agreement.
- This warranty only applies to goods supplied and installed in the North and South Islands of New Zealand.
- The provisions of this warranty are in addition to the rights and remedies available to consumers under the Consumer Guarantees Act 1993.

The Warranty is not valid:

- If the product is not installed and operated in accordance with the operating instructions.
- If the product is not installed to comply with the electrical, gas, plumbing and other Regulations and Codes of Practice in New Zealand.
- If the product is operated on voltages or frequencies outside the normal range for domestic appliances in New Zealand.
- If the product is not used in normal domestic use, or if it is used in a business as defined in the Consumer Guarantees Act.
- If any serial number has been removed or defaced.
- If proof of date of purchase is not supplied, except at the sole discretion of Parmco Sales. Proof of purchase can be for the product itself, or if installed with a kitchen or house then proof of purchase can be from a Parmco reseller of products supplied by Parmco.
- If the products are purchased in a second hand condition from other parties (including but not limited to TradeMe, Sella, etc.)

Liability under this warranty will not be accepted for:

- Wear and tear caused by normal domestic use of the product.
- Damage in transport.
- Damage caused to the product by neglect, abuse, negligence, willful act or misuse.
- Any costs associated with the repair, replacement, removal or reinstallation of products installed in a damaged condition.
- Any defect caused by accident, misuse, neglect, tampering with or unauthorised modifications of the appliance or any attempt at internal adjustment or repair by any person other than an Authorised Service Agent.
- Service calls that relate principally to the following:
 - Instruction on how to use the product.
 - Repair or replacement of house fuses, electrical wiring, gas fitting or plumbing.
 - Normal or scheduled maintenance including blocked filters or ducting.
 - Consumable items such as light bulbs.
 - Any damage to hobs caused by spills when cooking.
 - Any breakage or damage of glass items.
 - Any damage caused by non recommended product used for cleaning, maintaining, lubricating or similar.
 - Any aspect relating to the installation of the product, or damage caused during installation including blocked access for repair.
 - Any third party (including reseller) or consequential loss or damage (direct or indirect) however arising.

Product _____	Date of purchase _____
Serial Number _____	
Dealer / Retailer Name _____	
Please retain this Warranty card together with receipt or other proof of purchase date when seeking service during the warranty period	

Please contact Parmco at 09 573 5678 if your appliance needs servicing under warranty. Please have your model number and proof of purchase ready. Warranty repairs must be authorized by Parmco.

PREFACE

This washing machine conforms to current safety requirements. Inappropriate use can, however, lead to personal injury and damage to property.

To avoid the risk of accidents and damage to the washing machine, please read this manual carefully before using it for the first time. They contain important information on its installation, safety, use and maintenance.

Keep this manual in a safe place for future reference.

Contents

Safety notices	- 1
Parts and features	- 3
Installation	- 4
The functions of the control panel	- 7
How to use washer	- 9
Cleanness and Maintenance	- 12
Troubleshooting guide	- 14
Technical parameters	- 15
Electric Diagram	- 16



WARNING

Read and understand thoroughly these safety instructions before use. The items indicated here are very important safety precautions, which must be followed. We cannot be held liable for damage caused by non-compliance with the warning and safety instructions or resulting from incorrect use or operation.



Cleaning and user maintenance shall not be made by children without supervision. Children of less than 3 years should be kept away unless continuously supervised. The new hose-sets supplied with the appliance are to be used and the old hose-sets should not be reused.

This appliance is not intended for use by persons (including children) with reduced physical, sensory or mental capabilities, or lack of experience and knowledge, unless they have been given supervision or instruction concerning use of the appliance by a person responsible for their safety.

Children should be supervised to ensure that they do not play with the appliance. This appliance is intended to be used in household and similar applications such as:

- staff kitchen areas in shops, offices and other working environments;
- farm houses;
- by clients in hotels, motels and other residential type environments;
- bed and breakfasts type environments;
- areas for communal use in blocks of flats or in launderettes.

For washing machines having ventilation openings on the base, the washing machines cannot be washing on the carpet.

Technical safety

- Before setting the washing machine, check it for any externally visible damage. Do not install or use a damaged washing machine .
- Before connecting the washing machine, ensure that the connection data on the plate(voltage and current)match the electricity supply. if in any doubt, consult a qualified electrician.
- The electrical safety of this washing machine can only be guaranteed when continuity is complete between it and an effective earthing system which complies with current local and national safety regulations. It is most important that this basic safety requirement is present and regularly tested, and where there is any doubt the household wiring system should be inspected by a qualified electrician. The manufacturer cannot be held liable for the consequences of an inadequate earthing system.
- Do not connect the washing machine to the mains electricity supply by an extension lead. Extension leads do not guarantee the required safety of the appliance.
- Unauthorized repairs could result in unforeseen dangers for the user, for which manufacturer can not accept liability. Repairs should only be undertaken by an approved service technician. Ensure current is not supplied to the machine until after maintenance of repair work has been carried out.

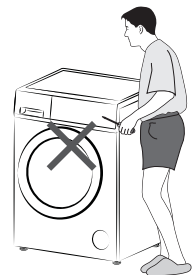

Safety Notices

Before Use

- If the connection cable is damaged or broken, it must only be replaced by an approved service technician to protect the user from danger.
- Faulty components must only be replaced by genuine manufacturer original spare parts. Only when these parts are fitted the safety standards of the machine can be guaranteed.

 **Note** THIS WASHING MACHINE MUST BE EARTHED.

Correct use

- To avoid the risk of personal injury or damage to the washing machine, do not install it in place where it is damp and where it suffers from rainfall.
- Do not install the washing machine in place where it suffers from the sun directly, in which plastic or components will be damaged. It will be shortened the life of your washing machine.
- Do not install the washing machine in place where temperatures below freezing may occur. Frozen hoses may burst or split. The reliability of the electronic control unit may be impaired at temperatures below freezing point.
- Do not shoot the washing machine with water when you clean it.
- Keep the washing machine away from fire or heat sources.
- Before using the washing machine for the first time, make sure that the transit bolts at the rear of the machine have been removed. During spinning, transit bolts which is still in place may result in damage to both the machine and adjacent furniture or appliances.
- Turn off the tap if the machine is to be left for any length of time (e.g. holiday), especially if there is no floor drain (gully) in the immediate vicinity.
- Take care to ensure that foreign objects (e.g. nails, pins, coins, paper clips) do not find their way into the machine with the laundry. These may damage components of the machine (e.g. drum), which in turn can result in damage to the laundry.
- Do not wash water-repellent things(e.g. raincoats) with washing machine.
- Only remove laundry from the washing machine once the drum has stopped turning. Reaching into a moving drum is extremely dangerous and could result in injury.

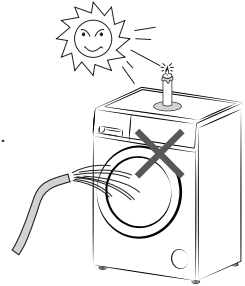

Safety with children

- Keep children away from the washing machine at all times. To avoid the risk of injury do not allow children to play on or near it or to play with its controls. Supervise children whilst you are using it.
- Older children may only use the washing machine if its operation has been clearly explained to them and they are able to use it safely, recognising the dangers of misuse.
- For machines with a 'porthole' door, remember that the porthole glass will be hot when washing at very high temperatures. Do not let children touch it.

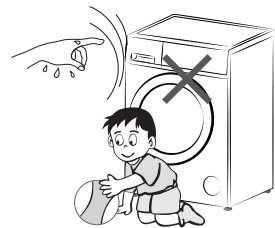

Parts and Features

Before Use

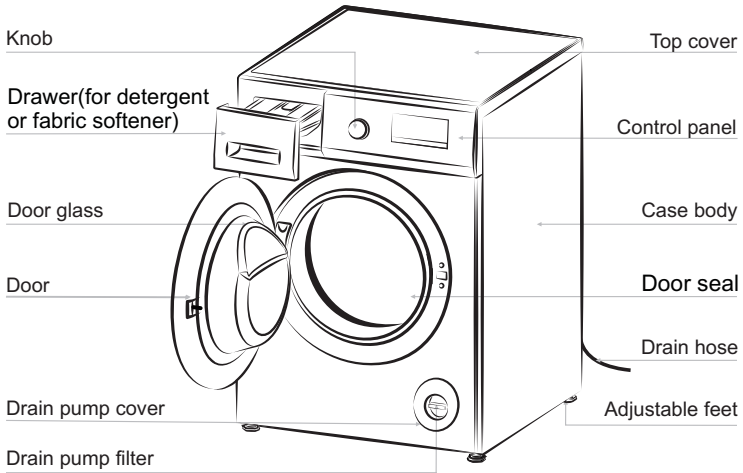

Note

Unscrew the drain pump filter to let water run out when the machine is not used for a long time.

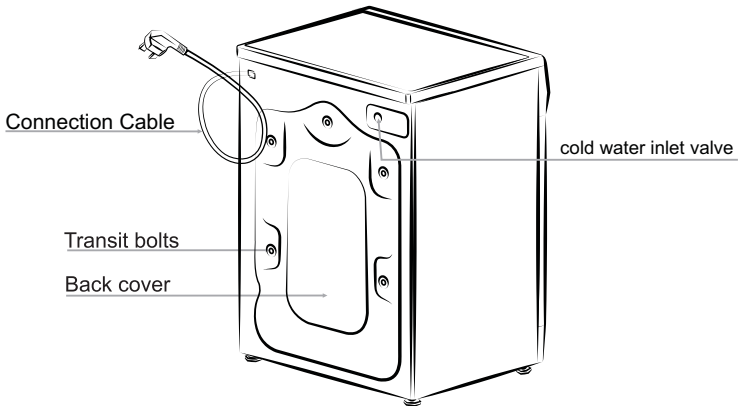

Note

The drawing of machine in the manual is only used for instruction. It may be vary from the mode you buy.

Installation

Before Use

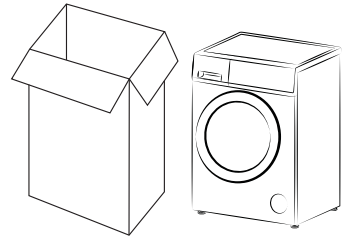

Backout packing

- Remove all the packing(including the foam base) or the vibration and noise may occur.
- Dispose all the wrappage safety and keep them out of the reach of children. Danger of suffocation!
- It is normal that water drops appear on the packing plastic bag and the door glass, which are resulted from the water left in the tub for checking out.

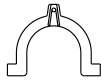

Accessories

Make sure that you have received all of the items shown below.

Accessories	Name	Qty.	Accessories	Name	Qty.
	Inlet hose	1		"U" piece	1
	transit bolts caps	4		Manual	1

Removing transit bolts

- Remove all the transit bolts at the back of the machine with tools.
- Plug the holes with the transit bolts caps supplied.



Note

Strong vibration, noise or failures may occur if the transit bolts are not removed.

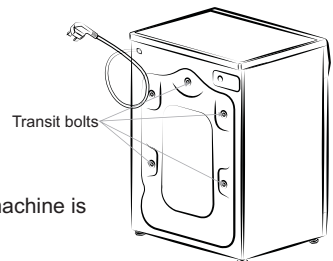

- Keep the transit bolts for future transportation. Whenever the machine is transported, the transit bolts must be refitted.

Installation place requirement

- A concrete floor is the most suitable installation surface for a washing machine, being far less prone to vibration during the spin cycle than wooden floorboards or carpeted surface.
- The machine must be level and securely positioned. The distance between the machine and wall must be more than 10 cm.
- To avoid vibrations during spinning, the machine should not be installed on soft floor coverings.

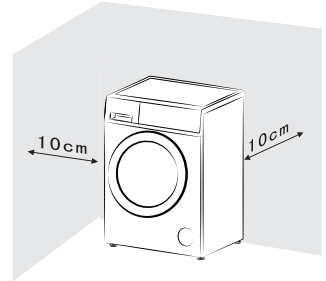

Level adjustment

The machine must stand perfectly level on all four feet to ensure safe and proper operation. Incorrect installation may cause vibrations and noise and may cause the machine to move about. To do these when the machine is not level:

- Using the spanner turn locknut in a clockwise direction. Then turn locknuts together with adjust feet to unscrew.
- Hold adjust feet securely with a pipe wrench. Turn locknut again using the spanner until it sits firmly up against the housing.

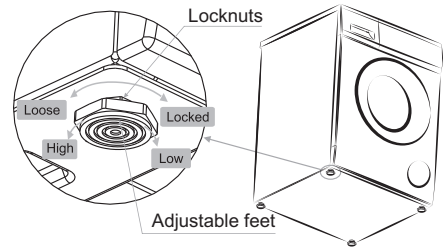

Note

Vibration and noise may occur if the locknuts do not sit firmly up against the houses.

Drain hose connection

1. Direct into a sink

If the outlet spigot has not been used before, remove any blanking plug that may be in place. Push the drain hose onto the spigot and secure with a clip if required, ensure a loop is formed in the drain hose to prevent waste from the sink entering the washing machine.

If required, the drain hose can be extended to a length of 4 m.

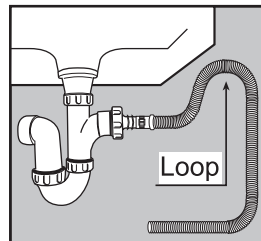
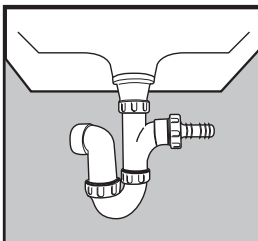

Installation

Use process

2. Connected securely to a standpipe

Firstly form a hook in the end of the drain hose using the "U" piece supplied.

Place the drain hose into your standpipe, which should have an internal diameter of approximately 38mm thus ensuring there is an air break between the drain hose and standpipe.

When discharging into a standpipe ensure that the top of the standpipe is no more than 90cm and no less than 60cm above floor level.

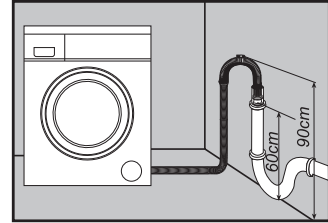
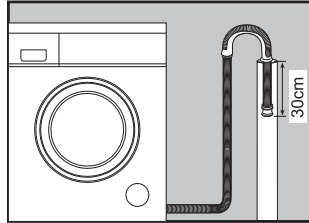

Water inlet connection

Connect the inlet hose supplied with the machine to a tap with a 3/4" thread.

Do not use previously employed hoses.

Installation should comply with local water authority and building regulations' requirements.

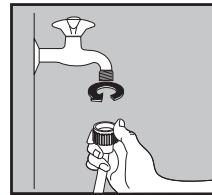
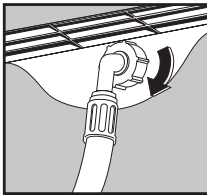

When there is a inlet valve at the back of the machine, it must be connected to a cold water supply. If there are two inlet valve, one is connected to a cold water supply and the other is connected to a hot water supply. Follow the indication of the picture below to complete the connection.

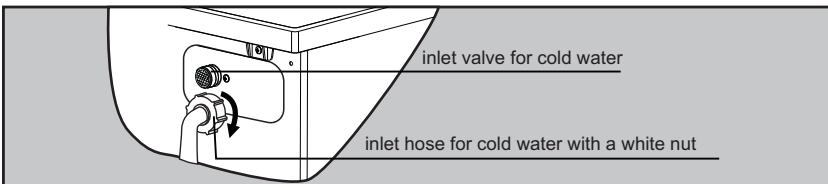

The functions of the control panel

Use process

The operation panel .

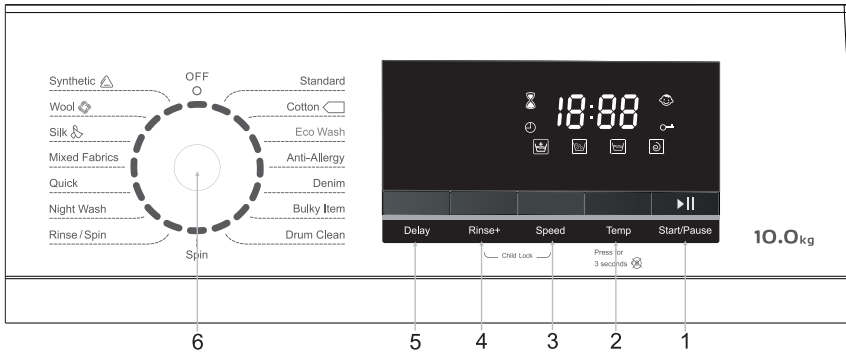

1.Start/pause (▶||)

Press this button to start or pause a wash cycle. The door can not be open when the machine pauses.

2.Temp

Press this button repeatedly to change the wash temperature. The detail is in the form on page 8.

3.Speed

Press this button repeatedly to change the spin speed. The detail is in the form on page 8.

4.Rinse+

Press this button repeatedly to change the rinse times. The detail is in the form on page 8.

5.Delay

Press this button repeatedly to set the delay time of the starting of a wash cycle form 1 hour to 24 hours.

6.Knob

Turn the knob clockwise or anticlockwise to select the required wash program. Once you press the Start/Pause button and the machine is running, the program can not be changed. The details of programs are in form on page 8.

(Note: At the end of a wash cycle, the knob must be turned to the position "O")



Note

For your safety, please not turn the knob to the position "O" and get clothes while the machine is running. Because the temperature of water may be high and it may scald you. The door lock will open automatically at the end of a wash cycle while the temperature of the drum is cool down.

● Child lock ("Rinse+ " + "Speed")

The function of "Child lock" is to lock the control panel to prevent the misuse by children .

1.Press the "Rinse+" and "Speed" buttons at the same time for 3 seconds.

When the icon "🔒" is lighted up on the screen, the function works. This function can be selected during a washing cycle.

2.When this function works, all keys and knob are not available, except for the knob turn to the position " O " .

● Mute ("Temp ")

The function of "Mute" is to close all the prompt tone and alert sounds.

How to start this function: Press the "Temp" button for 3 seconds.

How to cancel this function: Press the "Temp" button for 3 seconds again.









The functions of the control panel

Use process

Options and functions for programs

Program	Max weight (kg)	Max temp (°C)	Max spin speed (rpm)
Standard	10	90	1400
Cotton 	10	90	1400
Eco Wash	7	20	1200
Anti-Allergy	6	90	1000
Denim	6	40	800
Bulky Item	10	60	800
Drum Clean	0	90	800
Spin	10	--	1400
Rinse/Spin	10	--	1400
Night Wash	7.5	60	800
Quick	3.5	--	1200
Mixed Fabrics	6	60	1400
Silk	4	40	600
Wool	4	40	600
Synthetic	5	60	800

Display icon explanation

	Digital display: This icon shows the time, speed, rinse times, Error code.
	Remaining time: this icon will shinning once the display show the remaining time.
	Delay time: this icon will shinning once the display show the delay time.
	Child lock: this icon will shinning once child lock function is selected, otherwisw will gone.
	Door lock: this icon will shinning when door lock is working, otherwise will gone.
	Rinse+: this icon will shinning when the rinse+ function is selected.
	Main wash: The logo will be bright in standby condition when selected the program with main wash function, the logo will be flicked when machine during operation, and the logo will stay bright when machine in pause condition, the logo will be turn off when machine finishes operation.
	Rinse: The logo will be bright in standby condition when selected the program with rinse function, the logo will be flicked when machine during operation, and the logo will stay bright when machine in pause condition, the logo will be turn off when machine finishes operation.
	Final spin: The logo will be bright in standby condition, the logo will be flicked when machine during operation, and the logo will stay bright when machine in pause condition, the logo will be turn off when machine finishes operation.

**Note**

Once you select the “Night Wash” program, the machine will not execute the last drain unless the “ Start /Pause” button is pressed, and the screenshows “Iron”. (Note: the max running time of this function is 12 hours. If it exceeds 12 hours, the machine will drain and spin automatically.)

How to use washer

Use process

Before washing clothes for the first time, you must run a complete cycle without clothes.

To do these:

1. Connect the power and turn on the tap.
2. Turn the knob to position "Standard".
3. Press "Start/Pause".

It can remove the water which is left in the tub because of manufacturer's checking out.

Washing preparation

1. Connect the inlet hoses well and turn on the tap.
2. After making sure the power socket is grounded reliably, insert the power plug into the power socket.
3. Place the drain hose well.

Preparation of clothes

1. Sort the laundry by colour and by care label. Most garments have a textile care label in the collar or side seam.
2. Make sure all the pockets are empty, Foreign objects (e.g. nails, coins, paper clips, etc.) can cause damage to garments and components in the machine.
3. Close any zips, fasten hooks and eyes etc before washing.
4. Dark textiles often contain excess dye and should be washed separately several times before being included in a mixed load. Always wash whites and coloureds separately.
5. Badly soiled areas, stains etc. should be pre-treated with liquid detergent, stain removers etc.
6. Turn over the clothes which pill easily and is with woolen surface before putting them into the machine.

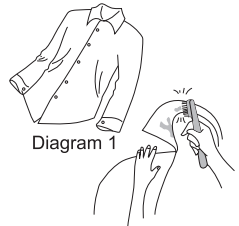

Diagram 1

Diagram 2



Diagram 3

Put clothes into the washer

Unfold the laundry and load loosely in the drum. Mixing both large and small items gives better wash results and also helps distribute the load evenly during spinning. The most efficient use of energy and water is achieved when a full load is washed. However, do not overload as this causes creases and reduces cleaning efficiency.

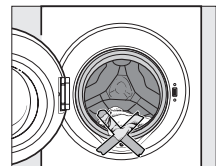







Make sure that no garments are caught between the door and the seal.

How to use washer

Use process

Using the detergent drawer

1. Open the drawer and add adequate detergent into main wash compartment marked “” or “”.
2. Add the fabric softener into compartment marked “” or “”.
Do not exceed the maximum level mark.
3. Add the detergent into the pre-wash compartment marked “” or “” according to the programme you select.
4. Close the drawer.

The right amount to dispenser will depend on the following:

- The quantity of laundry
- The soiling level of the laundry
 - Lightly soiled
No visible dirt or stains. Possibly slight body odour.
 - Normally soiled
Visibly dirty and/or just a few slight stains.
 - Heavily soiled
Visible dirt and stains and/or dried on soiling.
- The water hardness level.

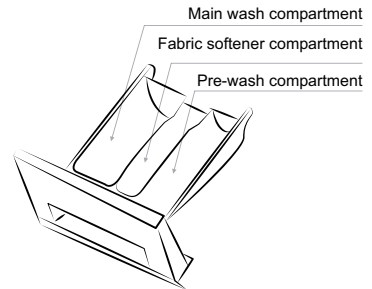

It is recommended to use low foaming powder for all washing temperature programs.







Washing steps

1. Turn on the water tap, and connect the power.
2. Open the door, and put the cloth into the drum one by one.
3. Close the door, and put suitable amount of detergent and fabric softener into the dispenser, then close the drawer.
4. Choose a programme you need by turning the knob .
5. Press the “Temp” button and select a wash temperature.
6. Press “ Start/Pause” button to start the washing machine.
7. When the cycle is finished, there is a warning tone sounds.

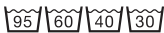

When washing cycle is finished, the machine will change into a standby mode. And the machine will be sleeping after 10 minutes without any control on the control panel.

Washing programme chart

Programme	Washing symbol	Fabric
Standard		Cottons, linens or cotton mix fabrics, e.g. table linen, towelling, underwear, T-shirts etc.
Quick		Small loads of items which require freshening up and which can be washed in a Cotton programme.
Rinse+Spin		This programme can be used for rinsing items which can be washed in a Cotton programme. Do not add any detergent.
Spin		Separate spin for cotton and linen items.
Cotton 		Cottons, linens or cotton mix fabrics, e.g. table linen, towelling, underwear, T-shirts etc.
Synthetic		Synthetic or mixed fabrics, underwear, coloured garments, non-shrink shirts.
Wool		Machine-washable or hand-washable wool or wool blend fabrics. If the care label does not specify a temperature, wash using the cold setting. Also suitable for hand-washable silks. Reduce the spin speed.



Note

The machine is fitted with a balance control device, which ensures the machine is stable during the spin. To protect the machine, it will cut in if the laundry is not evenly distributed in the drum. The laundry is redistributed by reverse rotation of the drum. This may happen several times before the unbalance disappears and normal spinning can resume. If, after 15 minutes, the laundry is still not evenly distributed in the drum, the machine will not spin. In this case, redistribute the load manually and reselect the spin programme.

Door lock

- When the machine is started, the door lock is locked. The door can be opened if you press the “Start /Pause” button during a cycle except the following two cases.
- When the temperature inside the drum is above 60°C, the door lock is locked.
- When the water is above a certain level, the door lock is locked.

Important:

Do not try to open the door when the washing cycle is not finished or power supply is cut off during the washing cycle, because the temperature may be high and you may be scalded.

Cleanness and Maintenance

After Use



Disconnect the machine from the mains electricity supply and withdraw the plug from the socket before cleaning the machine.



The washing machine must not be hosed down.



Cleaning the exterior

Clean the exterior with a mild non-abrasive cleaning agent or soap and water using a well wrung-out cloth. Wipe dry with a soft cloth.



Do not use solvents, abrasive cleaners, glass cleaners or all-purpose cleaning agents. These might damage plastic surfaces and other components because of the chemicals they contain.



The washing drum

Clean the drum every 3 months by using the "Drum clean" programme.



Cleaning the drawer

Remove detergent residues regularly. Clear the drawer following these:

- Pull out the drawer until a resistance is felt. Press down the release catch and at the same time pull the drawer right out of the machine.
- Remove the siphon from compartment and clean it.
- Clean the dispenser using a brush and warm water.

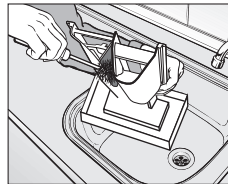
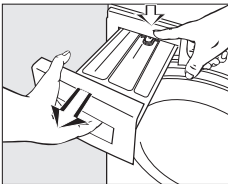

Cleaning the drawer housing

Use a bottle brush to remove detergent residues inside the drawer housing.

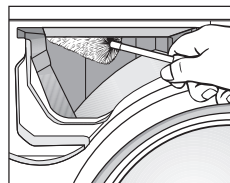

Cleaning the water inlet filter

Use pointed nose pliers to withdraw the plastic filter. Clean, put back and secure. These filter should be checked every 6 months or so, or more often if there are frequent interruptions to the water supply.

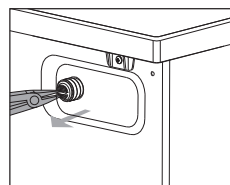

The filter must be put back in place after cleaning.

Cleaning the drain pump filter

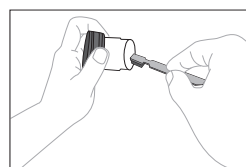
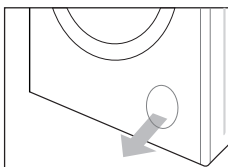

1. Disconnect the machine from the mains electricity supply and open the lower cover with a screwdriver.

2. Place a container under the pump. Unscrew and remove the filter.

3. Clean the filter carefully.



The filter should be cleaned every 2 months or so, or when there is fault that the "E03" is on the screen.

Important:

If the machine is exposed to temperatures below 0°C, certain precautions should be taken.

1. Turn off the water tap.
2. Unscrew the inlet hose.
3. Unhook the drain hose from the rear support and position the end of this hose and that of the inlet hose in a bowl. Run the spin programme.
4. Disconnect the appliance.
5. Screw the inlet hose and reposition the drain hose.
6. When you intend to start the machine up again, make sure that the room temperature is above 0°C.

Troubleshooting guide

Difficult explanation

Problem	Error Code	Possible Cause	Solutions
The machine fills overtime.	"E01" is on the screen.	<ol style="list-style-type: none"> 1. The water tap is not open. 2. The drain hose is put down. 3. The water inlet valve is damaged. 	<ol style="list-style-type: none"> 1. Open the water tap. 2. hook up the hose. 3. Change the water inlet valve.
There is a Door lock alarm.	"E02" is on the screen.	<ol style="list-style-type: none"> 1. The door is not locked well. 2. garment is caught between the door and the seal. 3. The door lock is damaged. 	<ol style="list-style-type: none"> 1. Lock the door well. 2. Put the garment into the drum. 3. Change the door lock.
The machine drains overtime.	"E03" is on the screen.	<ol style="list-style-type: none"> 1. The drain hose is squashed or kinked. 2. The drain pump filter is block. 3. The drainage system pipes are blocked. 	<ol style="list-style-type: none"> 1. Check the drain hose. 2. Clean the filter. 3. Check the drainage system and clean it.
Water overflows the machine. / Water sensor works abnormal.	"E04" is on the screen.	<ol style="list-style-type: none"> 1. The water inlet valve is damaged. 2. The connection between the water sensor and wire is not secure. 3. The water sensor is damaged. 	<ol style="list-style-type: none"> 1. Change the water inlet. 2. Check the connection and ensure it is secure. 3. Change the water sensor.
The motor does not work.	"E05" is on the screen.	<ol style="list-style-type: none"> 1. The connection between the motor and wire is not secure. 2. The motor is protected because of over-heat. 3. The motor is damaged. 	<ol style="list-style-type: none"> 1. Check the connection and ensure it is secure. 2. Check if the machine is overloaded. Switch off the machine, and retry when the motor becomes cool. 3. Change the motor.
There is a heating tube fault.	"E06" is on the screen.	<ol style="list-style-type: none"> 1. The connection between the heating tube and wire is not secure. 2. The heating tube is damaged. 	<ol style="list-style-type: none"> 1. Check the connection and ensure it is secure. 2. Change the heating tube.
There is a temperature sensor fault.	"E07" is on the screen.	<ol style="list-style-type: none"> 1. The connection between the temperature sensor and wire is not secure. 2. The temperature sensor is damaged. 	<ol style="list-style-type: none"> 1. Check the connection and ensure it is secure. 2. Change the temperature sensor.

Technical parameters

Parameter \ Model	WM10WF02
Power	220-240V~;50Hz
Washing / spin capacity	10.0kg
Rated power	2000W
Water pressure	0.02-0.8MPa
Net weight / gross weight	69kg/74kg
Outer dimension (W x D x H) mm	595X665X845

Energy-efficient test program entrance guide:

Choose the program “ cotton ”, set the washing temperature to “ 60°C”, and select the spin speed to “1400rpm”.

Note:

Data can vary from the nominal values given depending on water pressure, water hardness, water inlet temperature, room temperature, type and volume of load, fluctuations in the electricity supply and any extra options selected.

Symbol explanation

V	Volt	~	Alternating current
W	Watt	Hz	Hertz

Environmental Protection

Correct Disposal of this product



This marking indicates that this product should not be disposed with other household wastes throughout the EU. To prevent possible harm to the environment or human health from uncontrolled waste disposal, recycle it responsibly to promote the sustainable reuse of material resources. To return your used device, please use the return and collection systems or contact the retailer where the product was purchased. They can take this product for environmental safe recycling.

Electric Diagram

Electric Diagram

