

SONO III

220-240V ~ 50/60HZ IP54 IK10 -o- YLEISVALAISIN | RECESSED MNT. UNIV. LUMINAIRE | YTMONTAGE ALLMÄNBRUKSARMATUR
elektronisella liitäntälaitteella | med elektroniskt driftdon | with electronic ballast

4116462 / 4116464 / 4116465

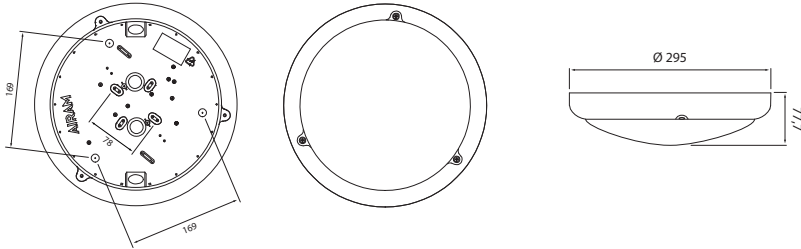

4116463

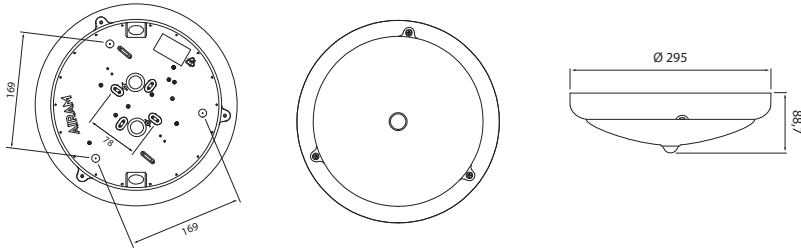

4126204 / 4126213

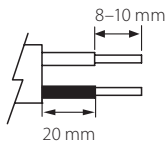
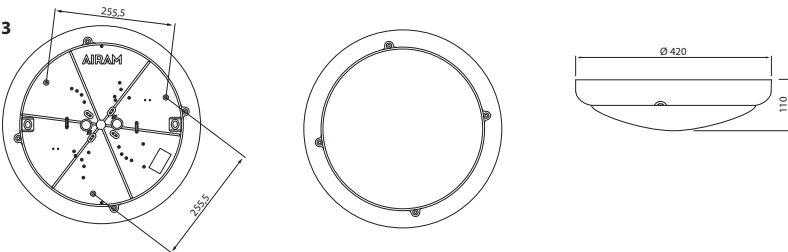
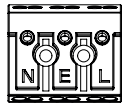
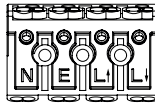
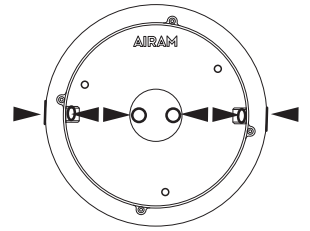
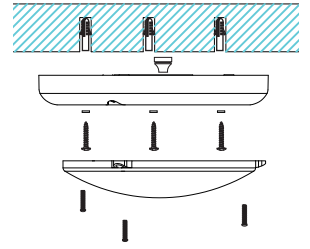
4116462
4116464
4126204-o- 3 x 2,5 mm²4116463
4116465
4126213RA -o- 4 x 2,5 mm²E = Maadoituksen jatkaminen /
päätyminen
E = Anslutning / avslutning av
jordningsledning
E = Continuity / termination of
earth wires

Nimelliskuorma maks. 15/21W

- ① Katkaise virta.
- ② Irrota valaisimen kupu poistamalla ruuvit.
- ③ Merkitse asennusreikien paikat.
- ④ Kytke asennusjohdot asianmukaisesti kytkentärimaan.
- ⑤ Kiinnitä valaisin pohjassa olevien kiinnitysreikien kohdista ruuveilla.
- ⑥ Kiinnitä PC-kupu valaisinrunkon ruuveilla.

Belastning: 15/21W max.

- ① Bryt strömmen.
- ② Lösgör kupan genom att öppna skruvarna.
- ③ Märk installationshålen.
- ④ Koppla ledningarna till kopplingsplinten.
- ⑤ Fäst armaturen i taket/på väggen.
- ⑥ Skruva fast kupan.

Rated load: 15/21W max

- ① Switch off the current.
- ② Unscrew to remove the diffuser.
- ③ Mark the places of screw points to wall or ceiling.
- ④ Attach the feeding cable to the terminal box.
- ⑤ Use the screw holes in the bottom of the luminaire for proper mounting.
- ⑥ Fix the diffuser to luminaire body with the screws.

SNRO	KOODI/CODE		LUMEN	KG	GTIN	E-NR
4116462	A1SOKA	SONO III IP54 15W/835	1300 lm	0,57	6435200216403	7502636
4116464	A1SOKC	SONO III 15W/835 RA 10-100	1300 lm	0,57	6435200216427	7502638
4116465	A1SOKD	SONO III IP54 15W/835 RA M-S	1300 lm	0,57	6435200216434	7502743
4116463	A1SOKB	SONO III IP54 15W/835 PIR M-S	1300 lm	0,57	6435200216410	7502637
4126204	A1SODE	SONO III 420 IP54 21W/835	1800 lm	1,20	6435200234582	7503683
4126213	A1SODF	SONO III 420 21W/835 RA M-S	1800 lm	1,25	6435200234773	7503684

Valaisimen saa asentaa vain sähköalan ammattilainen. Käytä ainoastaan syöttöjännitettä ja taajuutta joka on merkitty valaisimeen/ liitäntälaitteeseen. Kytke virta pois päältä ennen asennusta tai huoltoa. Tämä asennusohje on säilytettävä ja sen on oltava käytössä asennuksessa ja huollossa. Valonlähdettä ei voi vaihtaa. Vaihda tilalle uusi valaisin, jos valonlähde rikkoutuu (⚠).

Vi rekommenderar att installationen görs av en behörig elektriker. Använd endast driftspänning och frekvens som är märkt på armaturen/ förkopplingsdonet. Bryt av stömmen för installation eller service. Denna monteringsanvisning bör sparas och finnas tillgänglig vid installation eller framtida service. Ljuskälla kan inte byt ut, vänligen byt ut till en ny armatur om ljuskällan går sönder (⚠).

Only a professional electrician is allowed to do the installation. Use only rated voltage and frequency as marked in the fixture/driver. Switch off the current before installation or service. This mounting instruction must be kept available during installation and for future maintenance. The light source of this fixture cannot be replaced, please replace a whole new fixture if the light source is broken (⚠).

When choosing the place of installation pay attention to following things:

- Radar sensor can detect movements through thin wall or glass.
- The light fixture must be mounted on a stable foundation which doesn't vibrate.
- Large metal surfaces can affect the size and shape of the detection area.
- The lux values are referential.

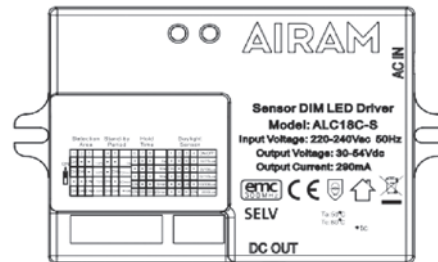

1. Microwave sensor

HF Operating Frequency	5.8 GHz \pm 75 MHz ISM wave band
HF Radiated power	<0.5mW max.
Detection Range	Detection surface radius 1-7 m (installation height 3 m)
Hold Time	5 s/30 s/90 s/6 min/20 min
Stand-by Period	0 s/10 min/60 min/+ ∞
Detection Area	100%/75%/50%/10%
Daylight Sensor	10 lux/25 lux/50 lux/150 lux/2000 lux
Mounting Height	Ceiling mounting 3-6 m, 6 m max
Detection Angle	150° (Wall mounting), 360° (Ceiling mounting)
Operating temperature/humidity	-25 °C ~ 50 °C humidity: 85% (non-condensing)
IP rating	IP20

2. WIRING DIAGRAM

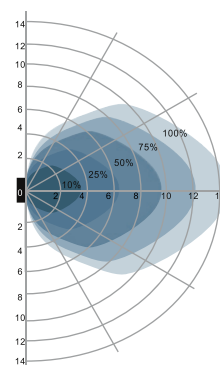
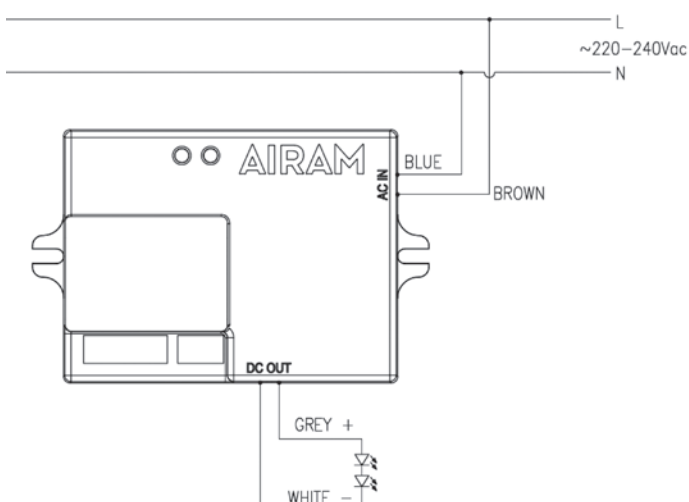

Ceiling mounting pattern (Unit: m)
Suggested installation height: 1-1,8 m

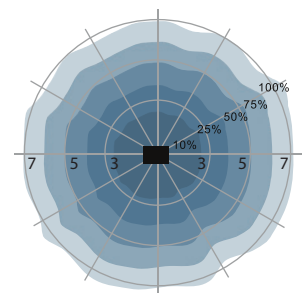

Wall mounting pattern (unit: m)
Suggested installation 1-7 m.

SONO III RA 10-100

4116463 / A1S0KB

3. FUNCTION



1. With sufficient ambient light, the light will not be switched on.



2. With insufficient ambient light, the sensor switches on the light when motion is detected.



3. After elapse of hold time, the sensor switches off the light when no motion is detected.



1. With sufficient ambient light, the light will not be switched on.

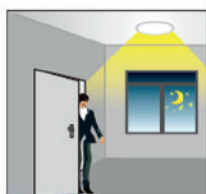

2. With insufficient ambient light, the sensor switches on the light when motion is detected.



3. After elapse of hold time, the sensor dims the light at a low light level if no new motion is detected.

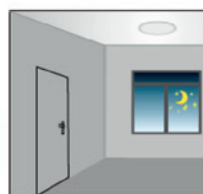

4. After elapse of stand-by period, the sensor switches off the light if no motion is detected in the detection zone.

4. SENSOR SETTING

Detection area

	1	2	3
10%	ON	-	-
50%	ON	ON	-
75%	-	-	ON
100%	ON	ON	ON

Stand-by period

	4	5
0 s	-	-
10 min	-	ON
60 min	ON	-
+ ∞	ON	ON

Hold time (SW2)

	6	7	8
8 s	-	-	-
30 s	-	-	ON
90 s	-	ON	-
6 min	ON	-	-
20 min	ON	ON	ON

Daylight Sensor (SW2)

	1	2	3	4
10/75 lux	-	-	-	-
25/100 lux	ON	-	-	-
50/150 lux	-	ON	-	-
150/300 lux	-	-	ON	-
2000 lux	-	-	-	ON

SONO III PIR/M-S

4116463 / A1S0KB

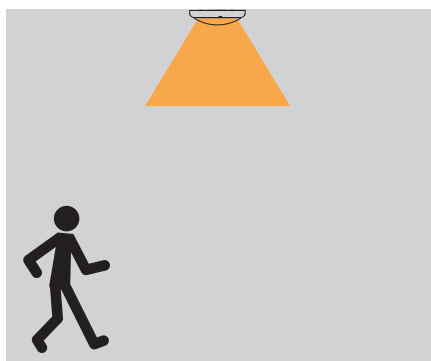
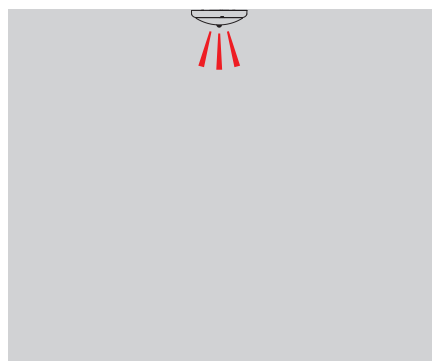

SETTING

Specification

Power source:	220 – 240V/AC
Power frequency:	50Hz
Ambient light:	3 – 2000 lux (adjustable)
Time-Delay:	min: 15 s ± 8 s max: 8 min ± 2 min
Rated load:	1200 W (incandescent lamp) 300 W (energy-saving lamp)
Detection distance:	2 – 8 m (<24 °C) (adjustable)
Detection range:	120°
Working temperature:	-20 ~ 40 °C
Working humidity:	<93%RH
Installation height:	2 ~ 3 m
Power consumption:	0.45W (work) 0.1W (static)
Detection motion speed:	0,6 ~ 1,5 m/s

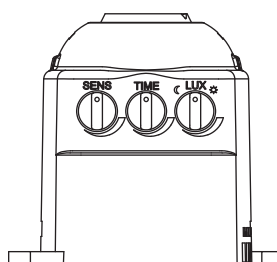

FUNCTION

- Can identify day and night: The consumer can adjust work ambient light. It can work in the daytime and at night when it is adjusted on the "sun" position (max). It can work in the ambient light less than 3 lux when it is adjusted on the "moon" position (min). As for the adjustment pattern, please refer to the testing pattern.
- SENS adjustable: It can be adjusted according to using location: 10w sensitivity with 2 m for detection distance; high sensitivity with 8 m, it fits for large room.
- Time-delay is added continually: when it receives the second induction signals after the first induction, it will compute time once more on the rest of the time-delay basic (set time).
- Time-delay adjustment: It can be set according to the consumer's desire. The minimum time is 5 s ± 1 s. The maximum is 8 min ± 2 min.

SONO III RADAR M-S

4116465 / 4126213

Huomioi asennuspaikkaa valittaessa seuraavat asiat:

- Liiketunnistin voi havaita liikkeen ohuen seinän tai lasin läpi.
- Asenna valaisin aina tärinättömälle alustalle.
- Suuret metallipinnat saattavat vaikuttaa tunnistusalueen kokoon ja muotoon.
- Lux-arvot ovat viitteelliset.

	Mikroaaltotutka
Virtalähde	220~240 Vac, 50 Hz
Nimelliskuorma	400 W (induktiivinen), 800 W (vastus)
HF-järjestelmä	5,8 GHz \pm 75 MHz, ISM-kaista
Lähetysteho	<0,5 mW
Tehonkulutus	\leq 0,5 W (valmiustila), <1 W (käyttö)
Tunnistusalue	Max. (D x H): 12 m x 6 m
Tunnistusherkyys	10% 25% 50% 75% 100%
Aika-asetukset	5 s 30 s 90 s 3 min 20 min 30 min
Valotunnistin	2 lux 10 lux 25 lux 50 lux ei kytketty
Asennuskorkeus	Maks. 6 m
Liikketunnistin	0,5~3 m/s
Tunnistuskulma	150° (seinäasennus), 360° (kattoasennus)
Lämpötila-alue	-20°C ~ 60°C
IP-luokitus	IP20

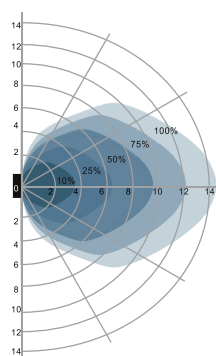
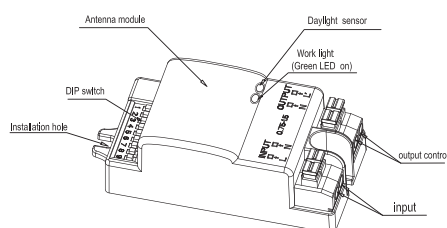
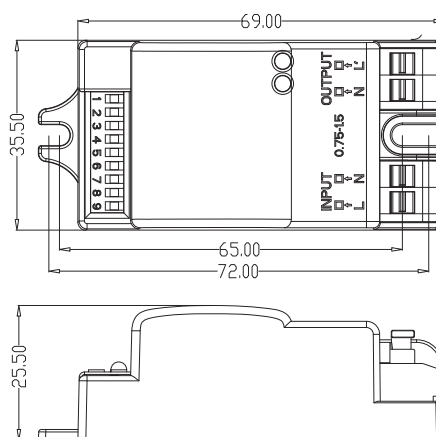

Tunnistusalue kattoon
asennettaessa (yksikkö: m)
Suositeltu asennuskorkeus: 1–1,5 m

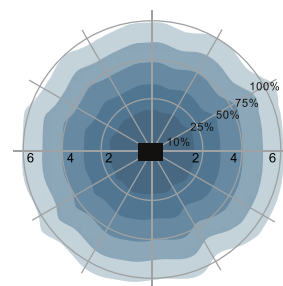

Tunnistusalue seinään
asennettaessa (yksikkö: m)
Suositeltu asennuskorkeus: 2,5–6 m.

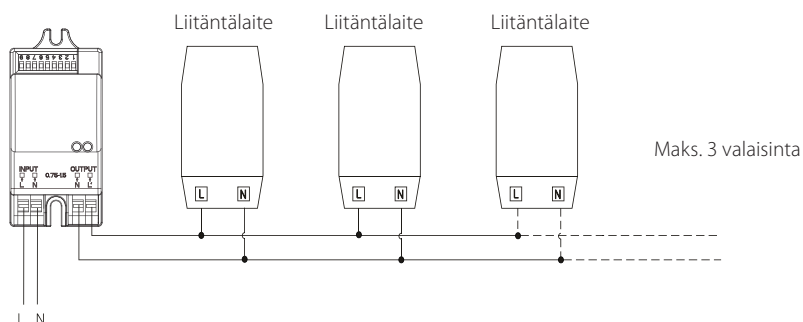
KYTKENTÄKAAVIO

ASETUKSET

Yhdistämällä kytkimien asentoja eri tavoin, tutkan asetukset voidaan sopeuttaa eri tarpeisiin ja tilanteisiin.

ON ↑ █	1	2	3	
	ON	ON	ON	100%
	-	ON	ON	75%
	ON	-	ON	50%
	-	-	ON	25%
	-	-	-	10%

TUNNISTUSALUE

Tunnistusaluetta voidaan kaventaa valitsemalla tarkoitukseen sopivin yhdistelmä.

ON ↑ █	4	5	6	
	ON	ON	ON	5s
	-	ON	ON	30s
	ON	-	ON	90s
	-	-	ON	3 min
	ON	ON	-	20 min
-	-	-	30 min	

AIKA-ASETUS

Aika-asetuksella tarkoitetaan aikaa, jolloin lamppu palaa täydellä teholla sen jälkeen kun liikettä ei enää tunnisteta.

ON ↑ █	7	8	9	
	ON	ON	ON	2 lux
	ON	ON	-	10 lux
	-	ON	-	25 lux
	ON	-	-	50 lux
	-	-	-	disable

VALOTUNNISTIN

Tunnistin voidaan asettaa niin, että lamppu syttyy vain jos ympäristön valoisuus alittaa tietyn valomäärän.

Kun valotunnistin on kytketty pois päältä (Disable), tutka sytyttää lampun ympäristön valoisuudesta riippumatta.

50 lux, 30 lux: syttyy hämärässä, 10 lux, 2 lux: syttyy vain pimeässä.

VIANETSINTÄ		
VIKA	AIHEUTTAJA	TOIMENPIDE
Tunnistin ei toimi.	Valittuna väärä valoisuusarvo.	Säädetään valoisuus.
	Tunnistin rikki.	Vaihdetaan valaisin/tunnistin.
	Kytkin poissa päältä.	Kytkin päälle.
Valot päällä jatkuvasti.	Jatkuvaa liikettä tunnistusalueella.	Tarkista tunnistusalueen asetukset.
Tunnistin toimii vaikka alueella ei ole liikettä.	Valaisin paikassa, jossa se ei pysty tunnistamaan.	Varmista asennuspaikka.
	Liikettä havaittavissa vaikka sitä ei näy (liikettä seinän takana, pieneläimet jne.).	Tarkista tunnistimen herkkyyasetukset.
Tunnistin ei reagoi nopeaan liikkeeseen.	Nopeiden liikkeiden tunnistusta on rajoitettu virhetoimintojen välttämiseksi tai tunnistusalue on liian kapea.	Tarkista tunnistusalueen asetukset.

SONO III RADAR M-S

4116465 / 4126213

Vid val av installationsplats bör följande beaktas:

- Radar detektorn kan eventuellt registrera rörelse genom en tunn vägg eller glas.
- Armatyren måste monteras på ett stabilt underlag som inte vibrerar.
- Stora metalltytor kan inverka på storleken och formen av detektionsområdet.
- Luxvärden som referens

	Mikrovågssensor
Strömförsörjning	220~240 Vac, 50 Hz
Nominell belastning	400 W (induktiv), 800 W (resistiv)
HF-system	5,8 GHz ± 75 MHz, ISM-frekvens
Sändareffekt	<0,5 mW
Energiförbrukning	≤0,5 W (standby) <1 W (drift)
Detektionsområde	Max (D x H): 12 m x 6 m
Detektionskänslighet	10% 25 % 50 % 75 % 100 %
Hålltid	5 s 30 s 90 s 3 min 20 min 30 min
Dagsljussensor	2 lux 10 lux 25 lux 50 lux avstängd
Monteringshöjd	Max 6 m
Rörelsedetektion	0,5~3 m/s
Detektionsvinkel	150° (väggmonterad), 360° (takmonterad)
Temperaturintervall	-20°C ~ 60°C
IP-klass	IP20

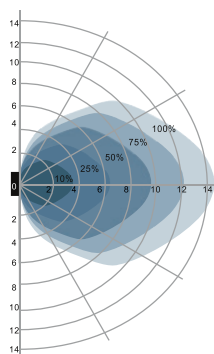
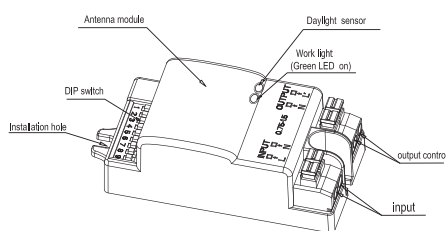
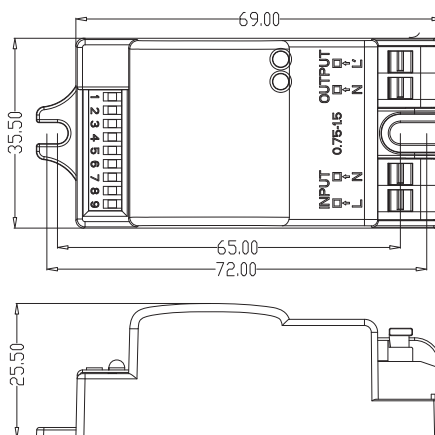

Detektionsmönster vid takmontering (enhet: m)
Förslag till installationshöjd: 1–1,5 m

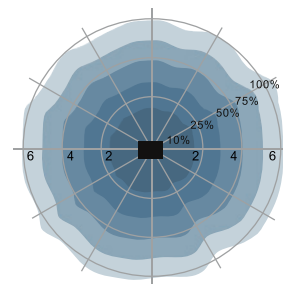

Detektionsmönster vid väggmontering (enhet: m)
Förslag till installationshöjd: 2,5–6 m

KOPPLINGSSCHEMA

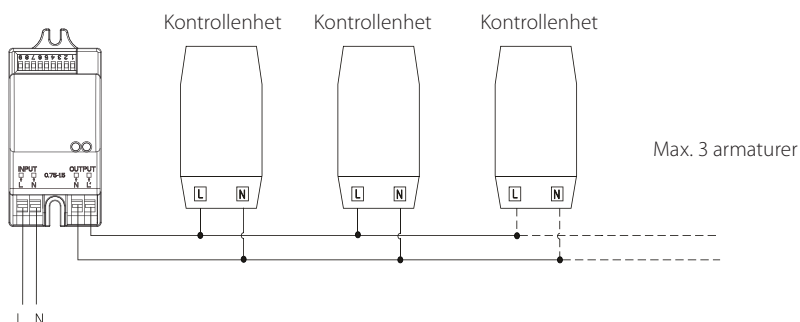

SONO III RADAR M-S

4116465 / 4126213

INSTÄLLNINGAR

Genom att kombinera olika positioner hos väljarna kan sensorn ställas in exakt för olika typer av behov.

ON
↑
█

1	2	3	
ON	ON	ON	100%
-	ON	ON	75%
ON	-	ON	50%
-	-	ON	25%
-	-	-	10%

DETEKTIONSOMRÅDE

Minska detektionsområdet genom att välja den kombination som passar bäst för dina ändamål.

ON
↑
█

4	5	6	
ON	ON	ON	5s
-	ON	ON	30s
ON	-	ON	90s
-	-	ON	3 min
ON	ON	-	20 min
-	-	-	30 min

HÅLLTID

Den tid under vilken lampan fortsätter att brinna med full ljusstyrka efter det att ingen rörelse längre detekteras.

ON
↑
█

7	8	9	
ON	ON	ON	2 lux
ON	ON	-	10 lux
-	ON	-	25 lux
ON	-	-	50 lux
-	-	-	disable

DAGSLJUSSENSOR

Denna sensor kan ställas in så att lampan endast tänds om den omgivande ljusstyrkan ligger under en given nivå.

I avstängt läge (Disable) tänder dagsljussensorn lampan då rörelsedetektorn uppfattar en rörelse, oavsett omgivningens ljusstyrka. 50 lux, 30 lux: tänds vid skymning, 10 lux, 2 lux: tänds endast vid mörker.

FELSÖKNING		
TYP AV FEL	ORSAK	LÖSNING
Detektorn slår inte till	Fel på ljusinställningarna.	Justera inställningarna.
	Fel på detektorenheten.	Byt detektorenhet.
	Huvudströmbrytaren är i OFF-läge.	Ställ huvudströmbrytaren i ON-läge.
Detektorn slår till hela tiden	Ständig rörelse inom detektionsområdet.	Kontrollera detektionsområdets inställningar.
Detektorn slår till utan att någon rörelse kunnat uppfattas	Sensorn har inte monterats för att pålitligt kunna detektera rörelse.	Kontrollera platsen för montering.
	Rörelse finns, som inte identifieras korrekt av sensorn (rörelse bakom en vägg, små objekt som rör sig alldeles intill lampan mm.).	Kontrollera zoninställningarna.
Detektorn slår inte till trots att rörelse förekommer.	Snabba rörelser ignoreras för att undvika felfunktion eller också är detektionsområdet för snävt inställt.	Kontrollera zoninställningarna.

SONO III RADAR M-S

When choosing the place of installation pay attention to following things:

- Radar sensor can detect movements through thin wall or glass.
- The light fixture must be mounted on a stable foundation which doesn't vibrate.
- Large metal surfaces can affect the size and shape of the detection area.
- The lux values are referential.

	Microwave sensor
Operating voltage	220~240 Vac, 50 Hz
Rated load	400 W (inductive), 800 W (resistive)
HF system	5,8 GHz ± 75 MHz, ISM wave band
Transmitting power	<0,5 mW
Power consumption	≤0,5 W (standby) <1 W (operation)
Detection zone	Max. (D x H): 12 m x 6 m
Detection sensitivity	10% 25 % 50 % 75 % 100 %
Hold time	5 s 30 s 90 s 3 min 20 min 30 min
Daylight sensor	2 lux 10 lux 25 lux 50 lux disable
Mounting height	Max 6 m
Motion detection	0,5~3 m/s
Detection angle	150° (wall installation), 360° (ceiling installation)
Operating temperature	-20°C ~ 60°C
IP rating	IP20

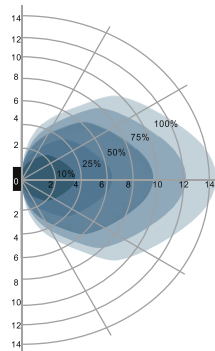
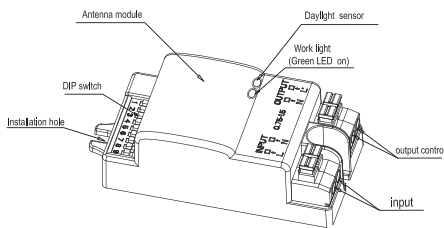
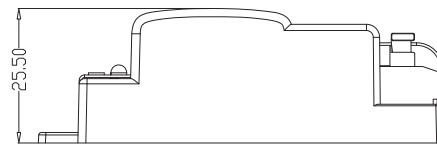
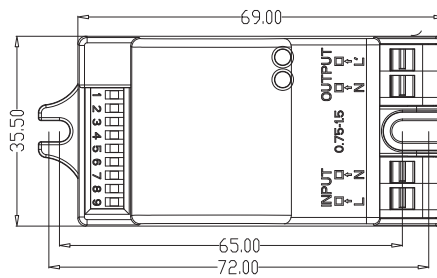

Ceiling mounting pattern (Unit: m)
Suggested installation height: 1-1,5 m

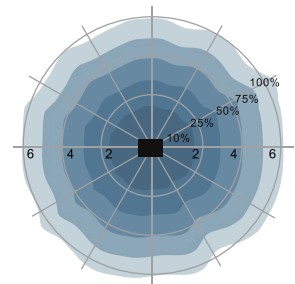

Wall mounting pattern (Unit: m)
Suggested installation height: 2,5-6 m

WIRING SCHEME

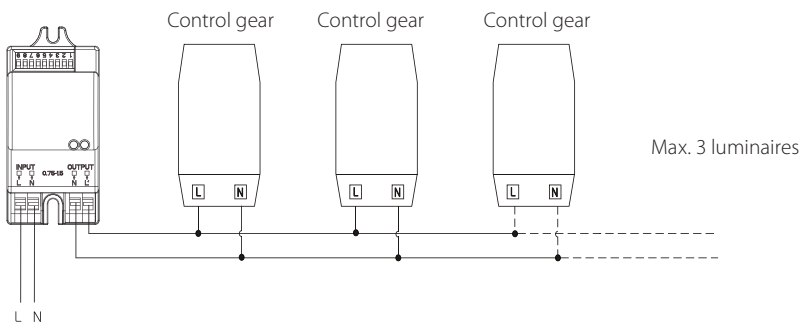

SONO III RADAR M-S

4116465 / 4126213

SETTING

By selecting the combination on the DIP switch, sensor data can be precisely set for each specific application.

	1	2	3	
ON	ON	ON		100%
	-	ON	ON	75%
	ON	-	ON	50%
	-	-	ON	25%
	-	-	-	10%

DETECTION AREA

Detection area can be reduced by selecting the combination on the DIP switches to fit precisely each application.

	4	5	6	
ON	ON	ON		5s
	-	ON	ON	30s
	ON	-	ON	90s
	-	-	ON	3 min
	ON	ON	-	20 min
	-	-	-	30 min

HOLD TIME

Refers to the time period the lamp remains at 100% illumination after no motion detected.

	7	8	9	
ON	ON	ON		2 lux
	ON	ON	-	10 lux
	-	ON	-	25 lux
	ON	-	-	50 lux
	-	-	-	disable

DAYLIGHT SENSOR

The sensor can be set to only allow the lamp to illuminate below a defined ambient brightness threshold.

When set to Disable mode, the daylight sensor will switch on the lamp when motion is detected regardless of ambient light level. 50 lux, 30 lux: twilight operation, 10 lux, 2 lux: darkness operation only.

TROUBLESHOOTING		
MALFUNCTION	CAUSE	REMEDY
The load will not work	Wrong light-control setting selected.	Adjust setting.
	Load faulty.	Change load.
	Main switch OFF.	Switch ON.
The load work always.	Continuous movement in the detection zone.	Check zone setting.
The load work without any identifiable movement.	The sensor not mounted for detecting movement reliably.	Securely mount enclosure.
	Movement occurred but not identified by the sensor (movement behind the wall, movement of the small object in immediate lamp vicinity etc.).	Check zone setting.
The load will not work despite movement	Rapid movements are being suppressed to minimize malfunctioning or the detection zone you have set is too small.	Check zone setting.