



# N1020 TEMPERATURE CONTROLLER



USER GUIDE – V2.0x D



1.	SAFETY ALERTS .....	3
2.	PRESENTATION .....	4
3.	INSTALLATION / CONNECTIONS .....	5
3.1	INSTALLATION RECOMMENDATIONS.....	5
3.2	ELECTRICAL CONNECTIONS.....	5
3.3	REMOVING THE REAR CONNECTOR.....	5
3.4	DIMENSIONS .....	6
4.	FEATURES .....	7
4.1	INPUT SIGNAL.....	7
4.2	OUTPUTS.....	7
4.3	CONTROL OUTPUT .....	7
4.4	ALARM OUTPUT.....	7
4.5	ALARM FUNCTIONS .....	7
4.5.1	TIMED ALARM ACTIVATION.....	8
4.5.2	ALARM INITIAL BLOCK.....	8
4.6	TIMER FUNCTION .....	8
4.7	RAMP FUNCTION (RATE).....	9
4.8	SOFT START .....	9
4.9	OFFSET.....	9
4.10	USB INTERFACE.....	9
4.11	SERIAL COMMUNICATION.....	10
5.	OPERATION.....	11
5.1	START UP.....	11
6.	PARAMETER DESCRIPTIONS.....	12
6.1	OPERATION CYCLE.....	12
6.2	CF-1 CYCLE – CONTROL ACTION.....	12
6.3	CF-2 CYCLE – ALARMS .....	13
6.4	CF-3 CYCLE – MEASUREMENT.....	14
6.5	CF-4 CYCLE – PROGRAMS.....	14
6.6	CF-5 CYCLE – TIMER.....	15
6.7	CF-6 CYCLE – ACCESS TO RESTRICTED PARAMETERS.....	15
6.8	MAP OF CYCLES AND PARAMETERS.....	16
7.	CONFIGURATION PROTECTION .....	17
7.1	PASSWORD.....	17
7.2	PASSWORD PROTECTION .....	17
7.3	MASTER PASSWORD .....	17
8.	PID CONTROL.....	18
8.1	AUTO-TUNING.....	18
8.2	SELF-ADAPTIVE MODE.....	18
9.	RAMPS AND SOAKS PROGRAM.....	20
9.1	PROGRAM RESTORE AFTER POWER FAILURE.....	20
9.2	PROGRAM LINK .....	20
10.	MAINTENANCE.....	21
9.1	PROBLEMS WITH THE CONTROLLER.....	21
9.2	INPUT CALIBRATION .....	21
11.	SPECIFICATIONS .....	22
12.	IDENTIFICATION.....	23
13.	WARRANTY.....	24

## 1. SAFETY ALERTS

The symbols below are used in the device and throughout this manual to draw the user's attention to valuable information related to device safety and use.

		
<b>CAUTION</b> Read the manual fully before installing and operating the device.	<b>CAUTION OR HAZARD</b> Risk of electric shock.	<b>ATTENTION</b> Electrostatic-sensitive device. Make sure you take the necessary precautions before handling it.

All safety recommendations appearing in this manual must be followed to ensure personal safety and prevent damage to the instrument or system. If the instrument is used in a manner other than that specified in this manual, the device's safety protections may not be effective.

## 2. PRESENTATION

**N1020** is an extremely versatile process controller. In a single model, it accepts most sensors and signals used in industry and provides the main types of output needed to act on several processes.

Configuration can be carried out directly on the controller or, once the **QuickTune** software has been installed on the computer to be used, via the USB interface. When the device is connected to USB, it will be recognized as a serial communication port (COM) operating with the Modbus RTU protocol.

Through the USB interface, even when disconnected from the power supply, the configuration performed on one device can be saved in a file and repeated on other devices that require the same configuration.

Its main features are:

- High-brightness red LED display.
- Universal input for thermocouples, Pt100 and 50 mV.
- Auto-tuning of PID parameters.
- 2 outputs: 1 pulse and 1 relay.
- Configurable outputs with 3 functions: Control, Alarm 1 and Alarm 2.
- Configurable alarms with 8 functions.
- Programmable Timer.
- **Soft Start** function.
- Ramp function.
- Password protection for configuration.
- Function to restore factory calibration.

### 3. INSTALLATION / CONNECTIONS

The equipment must be fixed to the panel, following the sequence of steps below:

- Cut-out the panel according to the [SPECIFICATIONS](#).
- Remove the mounting clamp from the equipment.
- Insert the equipment into the cut-out through the front of the panel.
- Replace the mounting clamp on the equipment, pressing until it is firmly attached to the panel.

#### 3.1 INSTALLATION RECOMMENDATIONS

- Input signal conductors should run through the plant separate from output and supply conductors. If possible, in grounded conduits.
- The power supply for electronic instruments must come from a network specific to the instrumentation.
- It is recommended to use RC FILTERS (noise suppressors) in contactor coils, solenoids, etc.
- In control applications, it is essential to consider what can happen when any part of the system fails. The internal devices of the equipment do not guarantee full protection.

#### 3.2 ELECTRICAL CONNECTIONS

The figure below shows the layout of the features on the rear panel of the controller:

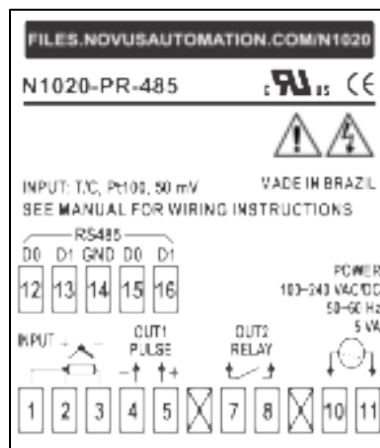

Figure 1

RS485 connection terminals are not available on all models. For more information, see [SERIAL COMMUNICATION](#) section.

#### 3.3 REMOVING THE REAR CONNECTOR

The figure below shows how to remove the rear connector from the device:

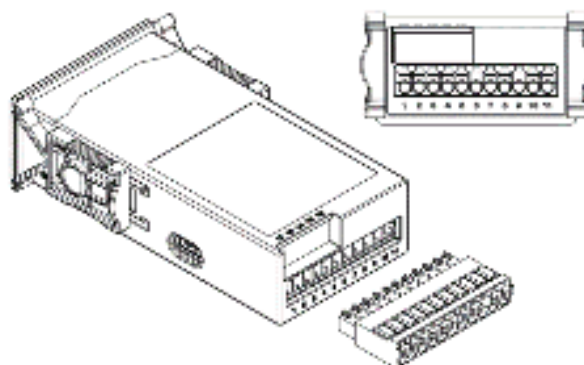

Figure 2

### 3.4 DIMENSIONS

The figure below shows the dimensions of the device:

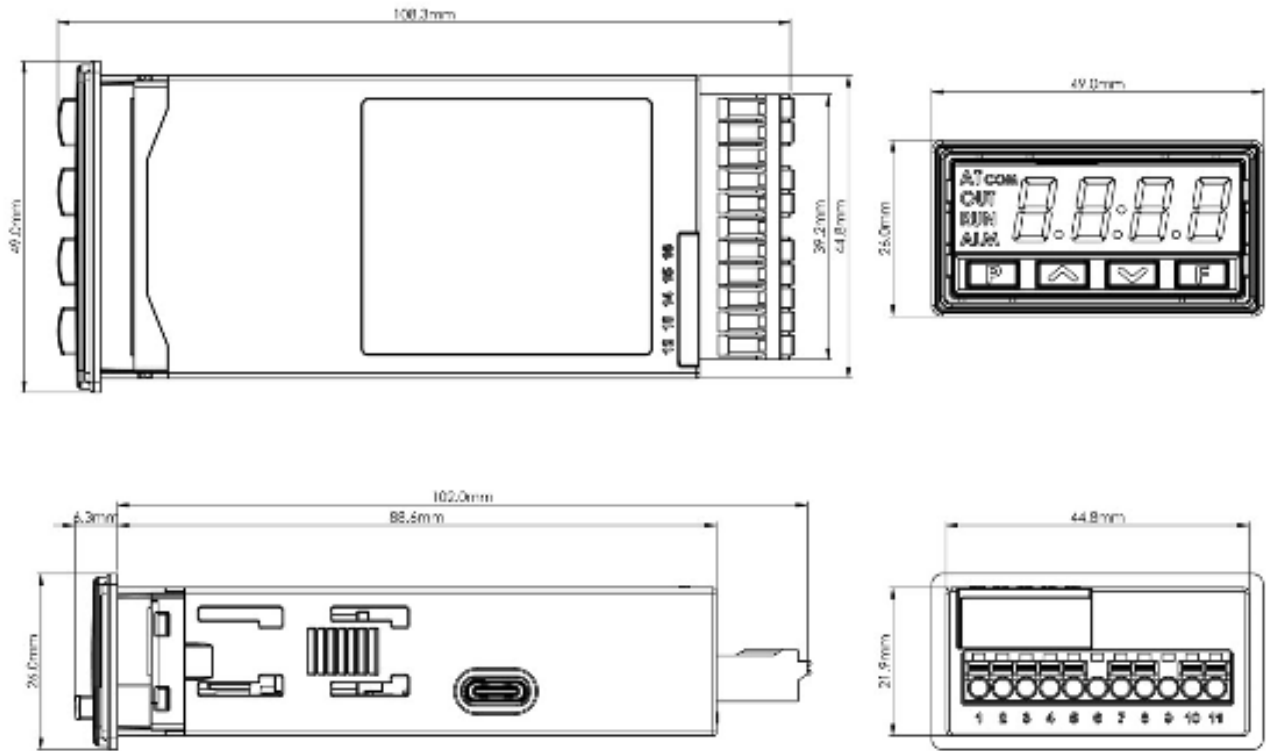

Figure 3

## 4. FEATURES

### 4.1 INPUT SIGNAL

The input type is defined during configuration. The table below shows the options available:

TYPE	CODE IN TYPE PARAMETER	MEASUREMENT RANGE
J	<b>tc J</b>	Range: -110 to 950 °C / -166 to 1742 °F
K	<b>tc P</b>	Range: -150 to 1370 °C / -238 to 2498 °F
T	<b>tc t</b>	Range: -160 to 400 °C / -256 to 752 °F
N	<b>tc n</b>	Range: -270 to 1300 °C / -454 to 2372 °F
R	<b>tc r</b>	Range: -50 to 1760 °C / -58 to 3200 °F
S	<b>tc S</b>	Range: -50 to 1760 °C / -58 to 3200 °F
B	<b>tc b</b>	Range: 400 to 1800 °C / 752 to 3272 °F
E	<b>tc E</b>	Range: -90 to 730 °C / -130 to 1346 °F
Pt100	<b>Pt</b>	Range: -200 to 850 °C / -328 to 1562 °F
0 to 50 mV	<b>LOSD</b>	Linear. Adjustable range between -1999 and 9999.

Table 1

### 4.2 OUTPUTS

The controller has 2 output channels. These channels must be configured to operate as: **1) Control Output, 2) Alarm Output 1, or 3) Alarm Output 2.**

OUTPUT 1      Electrical voltage pulse output, 5 Vdc / 25 mA.  
Available on terminals 4 and 5.

OUTPUT 2      SPST-NO relay, 1.5 A / 240 Vac.  
Available on terminals 7 and 8.

**Note:** The output channels can be freely configured. For example, you can set both as a control output.

### 4.3 CONTROL OUTPUT



The process control output can operate in ON / OFF mode or in PID mode.

### 4.4 ALARM OUTPUT

The controller has 2 alarms, which can be directed to any of the outputs. The alarms operate according to the configured alarm function.

### 4.5 ALARM FUNCTIONS

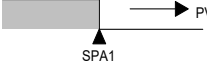
The alarms can be configured to operate with 8 functions:

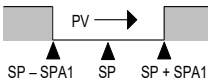
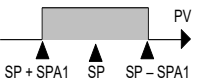
<b>oFF</b>	Alarm off.
<b>Lo</b>	<p>Absolute minimum value alarm. Triggers when the value of the measured variable (PV / Process Variable) is <b>below</b> the value set by the alarm Setpoint (<b>SPA1</b> or <b>SPA2</b>).</p> 
<b>HI</b>	<p>Absolute maximum value alarm. Triggers when the value of the PV is <b>above</b> the value set by the alarm Setpoint.</p> 
<b>dIF</b>	<p>Differential value alarm. In this function, the <b>SPA1</b> and <b>SPA2</b> parameters represent the deviation of the PV from the control SP.</p>
	 <p style="text-align: center;">positive SPA1</p>
	 <p style="text-align: center;">negative SPA1</p>

<b>d IFL</b>	Minimum differential value alarm. Triggers when the PV value is <b>below</b> the point set by (using alarm 1 as an example):	
	positive SPA1	negative SPA1
<b>d IFH</b>	Maximum differential value alarm. Triggers when the PV value is <b>above</b> the point set by (using alarm 1 as an example):	
	positive SPA1	negative SPA1
<b>r5</b>	Program segment. Triggered in a specific program segment.	
<b>iErr</b>	Sensor Break Alarm. Acts when the input has problems such as a broken sensor, poor connection, etc.	

Table 2

The examples above also apply to Alarm 2.

**Important note:** Alarms configured with the **H I**, **d IF** and **d IFH** functions also activate the related output when a sensor failure is identified and signaled by the controller. For example, a relay output, configured to act as a Maximum Alarm (**H I**), will act when the **SPAL** value is exceeded and when the sensor connected to the input is broken.

#### 4.5.1 TIMED ALARM ACTIVATION

The alarm trigger mode has 4 variations:

MODE	<b>Rlt1</b> <b>R2t1</b>	<b>Rlt2</b> <b>R2t2</b>	PERFORMANCE
Normal operation	0	0	
Timed activation	1 to 6500 s	0	
Delayed activation	0	1 to 6500 s	
Intermittent activation	1 to 6500 s	1 to 6500 s	

Table 3

The flag linked to the alarms lights up whenever an alarm condition occurs, regardless of the status of the alarm outputs. The alarms leave the factory with the alarm activation mode set to Normal Operation.

#### 4.5.2 ALARM INITIAL BLOCK

This feature inhibits the alarm from being triggered if there is an alarm condition when the controller is turned on. The alarm will only be activated after the process has passed through a non-alarm condition.

The Initial Block is useful, for example, when one of the alarms is configured as a minimum value alarm, which can cause the alarm to be triggered as soon as the process starts (an often-undesirable behavior).

The initial block is not valid for the following functions: Timer On, Timer End, and Open Sensor.

#### 4.6 TIMER FUNCTION

The controller has a countdown timer for applications that require time monitoring during the control process.

Once the time interval is set in parameter **tIE**, the options for starting the timer are:

- The instant the PV value reaches the control SP value.
- When enabling control (**run = YES**).
- By pressing the **F** key:
  - **Reset mode:** Pressing the **F** key will instantly reset the timer and start a new counting.
  - **On/Off mode:** Pressing the **F** key will stop the counting. Pressing the **F** key again will restart the timer where it left off.

The operations for ending the timer are:

- At the end of the timing process, it will turn off the control (**run = no**).
- At the end of the timing process, the control will not be affected.

Alarm **T1** can be linked to OUT1 and/or OUT2 outputs. To link the alarm, the desired output must be configured as **Alarm Output 1 or 2** and the respective alarm must be configured with the **Lon** or **tEnd** alarm functions:



- tOn** The output will be switched on during the timer.
- tEnd** The output will be switched on at the end of the timer.

## 4.7 RAMP FUNCTION (RATE)

This feature allows the SP value to be reached gradually. The SP value is incremented gradually from an initial value (PV value) until it reaches the configured value. The **rRtE** parameter sets this increase in the SP value in degrees per minute.

When the controller is turned on, the control is enabled (**run = YES**) or the SP value is changed, the Ramp function is activated.

To disable this function, set the parameter **rRtE** to 0.

## 4.8 SOFT START

This feature limits the MV value (Manipulated Variable), preventing maximum power from being applied instantaneously to the process load.

A time interval defines the maximum rate of increase of the power delivered to the load, where 100 % of the power will only be reached at the end of this interval.

The amount of power delivered to the load is still determined by the controller. The **Soft Start** function simply limits the speed at which this power value rises over the time interval set by the user.

The **Soft Start** function is normally used in processes that require a slow start, where the instantaneous application of 100 % of the available power to the load could damage parts of the process.

To disable this function, set the parameter to 0.

## 4.9 OFFSET

This feature allows you to make a small adjustment to the PV indication to correct measurement errors that appear, for example, when replacing temperature sensors.

## 4.10 USB INTERFACE

The USB interface is used to CONFIGURE, SUPERVISE, or UPDATE THE FIRMWARE of the controller. To do this, you must use the **QuickTune** software, which offers features for creating, viewing, saving, and opening settings from the device or from files on your computer. Saving and opening settings in files allows you to transfer settings between devices and make backup copies.

For specific models, **QuickTune** allows you to update the controller's firmware (internal software) via the USB interface.

To SUPERVISE, you can use any supervisory (SCADA) or laboratory software that supports Modbus RTU communication over a serial communication port. When connected to the USB of a computer, the controller is recognized as a conventional serial port (COM x).

You must use the **QuickTune** software or consult the Device Manager in the Windows Control Panel to identify the COM port assigned to the controller.

It is necessary to consult the Modbus memory mapping in the controller's communication manual and the documentation for its supervisory software.

To use the USB communication of the device, follow the procedure below:

1. Download the free **QuickTune** software from our website and install it on the computer to be used. In addition to the software, the USB drivers needed to operate communication will also be installed.
2. Connect the USB cable between the device and the computer. The controller does not need to be powered. The USB will provide sufficient power for communication operation (other functions may not operate).
3. Run **QuickTune**, configure communication, and start device recognition.



**The USB interface IS NOT ISOLATED from the signal input (PV) and the digital inputs and outputs of the controller. Its purpose is temporary use during CONFIGURATION and SUPERVISING periods.**

**For the safety of people and equipment, it should only be used when the device is completely disconnected from the input/output signals.**

**In any other connection condition, the use of USB is possible, but requires careful analysis by the person responsible for its installation.**

**For SUPERVISING over long periods and with inputs and outputs connected, we recommend using the RS485 interface, available or optional on most of our products.**

## 4.11 SERIAL COMMUNICATION

Optionally, the controller can be supplied with an RS485 asynchronous serial communication interface, master-slave type, for communication with a supervisory computer (master). The controller always acts as a slave.

Communication is initiated by the master, which transmits a command to the address of the slave it wishes to communicate with. The addressed slave accepts the command and sends the corresponding response to the master.

The controller also accepts Broadcast commands.

The serial communication terminal is located on the back of the device, as shown in the figure below:

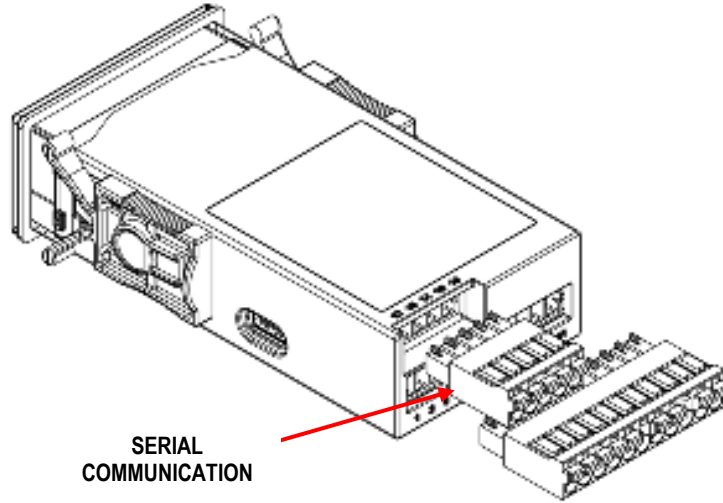

Figure 4

The table below helps you connect the RS485 communication interface:

D1	D	D $\bar{1}$	B	Bidirectional data line.
D $\bar{1}$	D $\bar{1}$	D	A	Inverted bidirectional data line.
C			Optional connection that improves communication performance.	
GND				

Table 4

For complete information, refer to the **Table of Registers for Serial Communication**, available on the page of **N1020**.

## 5. OPERATION

The front panel of the controller can be seen in the figure below:



Figure 5

**Display:** Displays the current PV value (Process Variable). When accessing the configuration parameters, the display shows the parameter symbol and the parameter value alternately. To distinguish it from the parameter symbol, the parameter value is displayed with a slight blink.

The display also shows the **AT**, **OUT**, **RUN**, **ALM**, and **COM** flags:

**AT flag:** Remains on while the controller is in the tuning process. Blinks slowly while it is in the learning period of the Self-Adaptive process.

**OUT flag:** Signals the status of the control output.

**RUN flag:** Stays on as long as the outputs of the controller are enabled (**run = YES**). Blinks slowly (2x) when the controller outputs are disabled (**run = no**).

**ALM flag:** Signals the occurrence of an alarm condition. It lights up whenever any alarm is activated.

**COM flag:** Signals when there is RS485 activity.

**P key:** Key used to advance through the successive parameters and parameter cycles.

**▲ Increment key and ▼ Decrement key:** Keys used to change parameter values.

**F key:** Key used to perform special functions: Timer control, RUN, etc.

### 5.1 START UP

When the controller is turned on, the display will show the version of the internal software during the first 3 seconds. It then switches to **OPERATION** mode, showing the value of the process variable (PV, typically temperature) on the display.

In **CONFIGURATION** mode, the parameters displayed are grouped. These groups are called Configuration Cycles (**CF**) of parameters. The controller has 6 Configuration Cycles:

**CF-1:** Parameters related to control actions.

**CF-2:** Parameters related to alarm operation.

**CF-3:** Parameters related to measuring PV.

**CF-4:** Parameters related to the programs.

**CF-5:** Parameters related to timing.

**CF-6:** Restricted parameters.

For a complete list of cycles and parameters, see [MAP OF CYCLES AND PARAMETERS](#) section.

To enter Configuration mode, press and hold the **P** key from the temperature display screen (PV). The cycles will be accessed in sequence:

**PV** → **CF-1** → **CF-2** → **CF-3** → **CF-4** → **CF-5** → **CF-6** → ...

To access the desired cycle, simply press the **P** key on the desired cycle identifier: **CF-1**, **CF-2**, .....

To advance through the parameters of a cycle, press the **P** key with short touches.

To go back to the previous parameters, press the **F** key in Configuration mode.

Each parameter is shown on the display alternately with its value (or condition). The parameter value is shown with a slight flash in the display brightness.

The **▲** and **▼** keys allow you to change the parameter setting.

When moving forward (or backward) to the next parameter, the changes made will be saved and adopted by the controller.

#### Important notes:

1. When it is necessary to change the controller's configuration, it is recommended to disable or suspend the controller's action on the process (**run = no**).
2. According to the protection configuration adopted, the **PRSS** parameter is displayed as the first parameter of the accessed cycle. See [CONFIGURATION PROTECTION](#) chapter.
3. If a change is made but the user does not move on to the next parameter, the controller will implement the change and return to the measurement screen after 20 seconds.
4. Changes made to the SP parameter will be implemented by the controller immediately, even before moving on to the next parameter.

## 6. PARAMETER DESCRIPTIONS

### 6.1 OPERATION CYCLE

<b>PV</b>	Screen for displaying the value of the process variable (PV / Process Variable). Main screen.
<b>Timer</b>	Timer indication screen. Displays the time remaining until the end of the timer. Displayed when the Timer function is used ( <b>t t t E</b> ≠ 0) (HH:MM).
<b>SP</b> Setpoint	Allows you to adjust the control Setpoint (SP).
<b>t t t E</b> Timer	Allows you to adjust the timer. From 00:00 to 99:59 (HH:MM). This parameter will be displayed if it has been enabled in the <b>t t t E n</b> parameter of <b>CF-5</b> cycle.
<b>r R t E</b> Rate	Ramp function. Allows you to set the SP value increment in degrees per minute.
<b>r u n</b> Run	Allows you to enable the controller to act on the process. If the controller is not enabled, the outputs will remain off continuously. <b>y E S</b> The controller is authorized to act. <b>n o</b> The controller is not authorized to act.

### 6.2 CF-1 CYCLE – CONTROL ACTION

<b>CF-1</b>	
<b>[r t y]</b> Control Type	Allows you to set the type of control to be used by the controller: <b>P i d</b> The controller uses PID control mode. <b>o n o f f</b> The controller uses ON / OFF control mode.
<b>A t u n</b> Auto-tune	Allows you to define the strategy to automatically determine the <b>P b</b> , <b>i r</b> , and <b>d t</b> (PID) parameters of the PID control mode: <b>o f f</b> The automatic tuning is off. Do not perform tuning. <b>F A S t</b> Runs a Fast auto-tuning. <b>F U L L</b> Runs a Precise auto-tuning. <b>S E L F</b> Enables the Self-adaptive mode. <b>r S L F</b> Forces a new Precise auto-tuning and return to Self-adaptive mode. <b>t G h t</b> Forces a new Precise auto-tuning every time the control is restarted, returning to Self-adaptive mode. See <a href="#">DEFINITION OF PID PARAMETERS</a> chapter. This parameter will only be available for PID control mode.
<b>P b</b> Proportional Band	Proportional Band. Allows you to set the value of the <b>P</b> term of the PID control mode. Percentage of the maximum range of the input type. Adjustable between 0.1 and 500.0 %. This parameter will only be available for PID control mode.
<b>i r</b> Integral Rate	Integral Rate. Allows you to set the value of the <b>I</b> term of the PID control mode. In repetitions per minute (Reset). Adjustable between 0 and 99.99. This parameter will only be available for PID control mode.
<b>d t</b> Derivative Time	Derivative Time. Allows you to set the value of the <b>D</b> term of the PID control mode. In seconds. Adjustable between 0 and 300.0 seconds. This parameter will only be available for PID control mode.
<b>[c t]</b> Cycle Time	PWM cycle time. Allows you to set the PWM cycle period value of the PID control mode. In seconds. Adjustable between 0.5 and 100.0 seconds. This parameter will only be available for PID control mode.
<b>H Y S t</b> Hysteresis	Control hysteresis. Allows you to set the hysteresis value for the ON / OFF control mode. Adjustable between 0 and the width of the measurement range of the selected input type. This parameter will only be available for ON / OFF control mode.
<b>A C t</b> Action	Allows you to define the control logic: <b>r E</b> Control with <b>Reverse Action</b> . Suitable for <b>heating</b> . Turns on the control output when PV is below SP. <b>d i r</b> Control with <b>Direct Action</b> . Suitable for <b>refrigeration</b> . Turns on the control output when PV is above SP.

<b>ouLL</b> <i>Output Low Limit</i>	<p>Allows you to define the lower limit for the control output. Minimum percentage value assumed by the control output when in PID mode.</p> <p>Typically set to 0 %.</p> <p>This parameter will only be available for PID control mode.</p>
<b>ouHL</b> <i>Output High Limit</i>	<p>Allows you to define the upper limit for the control output. Maximum percentage value assumed by the control output when in PID mode.</p> <p>Typically set to 100 %.</p> <p>This parameter will only be available for PID control mode.</p>
<b>SFSL</b> <i>Soft Start</i>	<p><b>Soft Start</b> function.</p> <p>Allows you to set a time interval (in seconds) during which the controller limits the MV (Manipulated Variable) value to limit the power delivered to the load.</p> <p>Adjustable between 0 and 9999 seconds.</p> <p>To disable this function, set the parameter to 0.</p> <p>This parameter will only be available for PID control mode.</p>
<b>out 1</b> <b>out 2</b> <i>Output 1</i> <i>Output 2</i>	<p>Allows you to define the operating mode of the OUT1 and OUT2 output channels:</p> <p><b>off</b> Not used.</p> <p><b>Ctrl</b> Acts as a control output.</p> <p><b>A1</b> Acts as alarm output 1.</p> <p><b>A2</b> Acts as alarm output 2.</p> <p><b>A1A2</b> Acts as alarm output 1 and alarm output 2 simultaneously.</p>

### 6.3 CF-2 CYCLE – ALARMS

<b>CF-2</b>	
<b>FuA1</b> <b>FuA2</b> <i>Alarm Function</i>	<p>Allows you to define the alarm functions. See <a href="#">ALARM FUNCTIONS</a> section.</p>
<b>SPA1</b> <b>SPA2</b> <i>Setpoint Alarm 1</i> <i>Setpoint Alarm 2</i>	<p>Alarm Setpoint. Allows you to set the trigger point for alarms programmed with <b>Lo</b> or <b>Hf</b> functions.</p> <p>For alarms programmed with <b>Differential</b> type, these parameters define deviations.</p> <p>It is not used for other alarm functions.</p>
<b>bLA1</b> <b>bLA2</b> <i>Blocking Alarm</i>	<p>Alarms initial blocking.</p> <p>Allows you to define the initial block function for alarms 1 to 2:</p> <p><b>YES</b> Enables the initial block.</p> <p><b>no</b> Inhibits the initial block.</p>
<b>HYA1</b> <b>HYA2</b> <i>Alarm Hysteresis</i>	<p>Alarm hysteresis.</p> <p>Allows you to define the difference between the PV value at which the alarm is switched on and the value at which it is switched off.</p>
<b>A t 1</b> <b>A t 1</b> <i>Alarm Time t1</i>	<p>Allows you to define the time interval <b>t1</b> for the alarm activation mode. In seconds.</p>
<b>A t 2</b> <b>A t 2</b> <i>Alarm Time t2</i>	<p>Allows you to define the time interval <b>t2</b> for the alarm activation mode. In seconds.</p>
<b>FLSH</b> <i>Flash</i>	<p>Allows you to signal the occurrence of alarm conditions by flashing the PV indication on the display screen:</p> <p><b>YES</b> Enables alarm signaling by flashing PV.</p> <p><b>no</b> Does not enable alarm signaling by flashing PV.</p>

## 6.4 CF-3 CYCLE – MEASUREMENT

<b>CF-3</b>	
<b>TYPE</b> Type	Allows you to select the input type to be used. See <a href="#">INPUT SIGNAL</a> section. <b>The first parameter to be configured.</b>
<b>FLtr</b> Filter	Digital input filter. Used to improve the stability of the measured signal (PV). Adjustable between 0 and 20. At 0 means that the filter is off. At 20 means that the filter is at maximum. The larger the filter, the slower the response of the measured value.
<b>dPPo</b> Decimal Point	Decimal point position. Allows you to define the position of the decimal point in the display. When configuring the input ( <b>TYPE</b> ) with temperature sensors (J, K, Pt100, etc.), in addition to the integer part of the measurement, the <b>dPPo</b> parameter will only display decimal values (XXX.X). When configuring the input ( <b>TYPE</b> ) with linear signals (mA, mV, V), the <b>dPPo</b> parameter establishes the position of the decimal point of the measured value (XXXX, XXX.X, XX.XX, X.XXX).
<b>un i t</b> Unit	Allows you to define the temperature unit to be used: Celsius or Fahrenheit. This parameter will only be displayed when using a temperature sensor.
<b>OFFS</b> Offset	Allows you to correct the indicated PV value.
<b>SPLL</b> SP Low Limit	Allows you to define the lower limit to adjust SP. For the 0-50 mV input type, this parameter defines the lower limit of the input indication scale.
<b>SPHL</b> SP High Limit	Allows you to define the upper limit to adjust SP. For the 0-50 mV input type, this parameter defines the upper limit of the input indication scale.
<b>run</b> Run	Allows you to enable control outputs and alarms: <b>YES</b> Enabled outputs. <b>no</b> Disabled outputs. <b>F,PEY</b> The F key enables and disables the control and alarm outputs. Same as the parameter presented in the Operation cycle.
<b>runEn</b> Run Enable	Allows the <b>run</b> parameter to be displayed in the Operation cycle: <b>En</b> Allows the parameter to be displayed in the Operation cycle. <b>d,5</b> Does not allow the parameter to be displayed in the Operation cycle.
<b>baud</b> Baud Rate	Allows you to set the communication Baud Rate (in kbps): 1.2, 2.4, 4.8, 9.6, 19.2, 38.4, 57.6, and 115.2.
<b>Prty</b> Parity	Allows you to define the parity of serial communication: <b>nonE</b> No parity. <b>E,EEi</b> Even parity. <b>Odd</b> Odd parity.
<b>Addr</b> Address	Allows you to define the communication address. Number between 1 and 247 that identifies the controller on the serial communication network.

## 6.5 CF-4 CYCLE – PROGRAMS

<b>CF-4</b>	
<b>Prty</b> Program time base	Allows you to define the type of program to be adopted by the controller: <b>nonE</b> Do not use any programs. <b>rRtE</b> Ramp to soak. <b>ProG</b> Ramps and soaks programs.
<b>rRtE</b> Rate	SP ramp. Allows you to set the SP increment rate by selecting the <b>rRtE</b> program type in the <b>Prty</b> parameter. Adjustable value in <b>degrees / minute</b> when in temperature control or when selecting the 0-50 mV signal type in the <b>TYPE</b> parameter. This parameter will only be displayed if <b>Prty = rRtE</b> .
<b>rRtEn</b> Rate Enable	Allows the <b>rRtE</b> parameter to be displayed in the Operation cycle: <b>Ei</b> Allows the parameter to be displayed in the Operation cycle. <b>d,5</b> Does not allow the parameter to be displayed in the Operation cycle. This parameter will only be displayed if <b>Prty = rRtE</b> .
<b>Pr. n</b> Program number	Allows you to select the ramps and soaks program to be defined in the following screens of this cycle. There are 5 programs (1 - 5). This parameter will only be displayed if <b>Prty = ProG</b> .

<b>P.tol</b> <i>Program tolerance</i>	<p>Allows you to define the maximum deviation that will be allowed between the PV and SP values. If exceeded, the program will be suspended (stop counting time) until the PV value is within the permitted deviation range.</p> <p>To disable this function, set the parameter to 0.</p> <p>This parameter will only be displayed if <b>Prty = Prog</b>.</p>
<b>P.SP0</b> <b>P.SP4</b> <i>Program SP</i>	<p>Allows you to set the SP values of the programs. 0 to 4. Set of 5 SP values that define the profile of the ramps and soaks program.</p> <p>This parameter will only be displayed if <b>Prty = Prog</b>.</p>
<b>P.t1</b> <b>P.t4</b> <i>Program time</i>	<p>Time of the program segments. 1 to 4. Allows you to set the duration (in seconds or minutes) of each of the 4 segments of the program being edited.</p> <p>This parameter will only be displayed if <b>Prty = Prog</b>.</p> <p>In the <b>tbRS</b> parameter, available in the Calibration cycle (<b>CF-6</b>), you can select the time unit to be adopted by the controller.</p>
<b>P.E1</b> <b>P.E4</b> <i>Program Event</i>	<p>Program segment alarm (Event Alarm). Allows you to define whether the alarm will be triggered during the execution of a given program segment:</p> <ul style="list-style-type: none"> <li><b>oFF</b> Do not trigger an alarm in this segment.</li> <li><b>R1</b> Trigger alarm 1 when the program reaches this segment.</li> <li><b>R2</b> Trigger alarm 2 when the program reaches this segment.</li> </ul> <p>The alarms adopted must be configured with the <b>rS</b> Event Alarm function. See <a href="#">ALARM FUNCTIONS</a> section.</p> <p>This parameter will only be displayed if <b>Prty = Prog</b>.</p>
<b>LP</b> <i>Link Program</i>	<p>Allows you to link programs. When a program has finished running, it is possible to immediately run any other program.</p> <ul style="list-style-type: none"> <li><b>0</b> Do not link it to any other program.</li> <li><b>1 to 5</b> Link the program under development to the program indicated on this screen.</li> </ul>

## 6.6 CF-5 CYCLE – TIMER

<b>CF-5</b>	
<b>tStr</b> <i>Program time base</i>	<p>Allows you to enable the timer and the trigger mode of the time count:</p> <ul style="list-style-type: none"> <li><b>oFF</b> Timer disabled. It will not be used by the controller (*).</li> <li><b>SP</b> Timer enabled. The timer is triggered when <b>PV</b> reaches <b>SP</b>.</li> <li><b>F.rSt</b> Timer enabled. The <b>F</b> key triggers the timer. Pressing the <b>F</b> key again will restart the timer.</li> <li><b>run</b> Timer enabled. The timer will start counting when the control is enabled (<b>run = YES</b>).</li> <li><b>F.StP</b> Timer enabled. The <b>F</b> key triggers the timer. Pressing the <b>F</b> key again will stop the time count. Pressing the <b>F</b> key again will restart the timer.</li> </ul>
<b>t.tE</b> <i>Timer</i>	<p>Allows you to set the timer interval.</p> <p>In seconds or minutes, as defined in parameter <b>tbRS</b>, available in the Calibration cycle (<b>CF-6</b>).</p>
<b>t.tEn</b> <i>Timer Enable</i>	<p>Allows the <b>t.tE</b> parameter to be displayed in the Operation cycle:</p> <ul style="list-style-type: none"> <li><b>En</b> Allows the parameter to be displayed in the Operation cycle.</li> <li><b>d.S</b> Does not allow the parameter to be displayed in the Operation cycle.</li> </ul>
<b>t.E.C.O</b>	<p>Allows you to define the control behavior at the end of the timer:</p> <ul style="list-style-type: none"> <li><b>no</b> The control is not changed at the end of the timer.</li> <li><b>YES</b> Control is disabled at the end of the timer (<b>run = no</b>).</li> </ul>

(\*) If you set the **tStr** parameter to **oFF**, the timer will be disabled, and the other parameters of this cycle will not be displayed.

## 6.7 CF-6 CYCLE – ACCESS TO RESTRICTED PARAMETERS

All input and output types are calibrated at the factory. When recalibration is necessary, it must be performed by a specialized professional. If you access it by accident, simply step through all the parameters, until the controller returns to the measurement screen.

<b>CF-6</b>	
<b>PRSS</b> Password	Allows you to enter the password. This parameter is displayed before the protected levels. See <a href="#">CONFIGURATION PROTECTION</a> chapter.
<b>CALib</b> Calibration	Allows you to calibrate the controller. If calibration is not enabled, the related parameters will remain hidden.
<b>inLC</b> Input Low Calibration	Allows you to enter the declaration of the calibration signal indicating the start of the range applied to the analog input. See <a href="#">MAINTENANCE</a> chapter.
<b>inHC</b> Input High Calibration	Allows you to enter the declaration of the calibration signal indicating the end of the range applied to the analog input. See <a href="#">MAINTENANCE</a> chapter.
<b>rStr</b> Restore	Allows you to restore the factory calibrations of the analog input and output, disregarding any changes made by the user.
<b>CJ</b> Cold Junction	Allows you to set the Cold Junction temperature of the controller.
<b>PRSC</b> Password Change	Allows you to set a new password, always different from 0. If you set this parameter to 0, the previously set password will be preserved.
<b>Prot</b> Protection	Allows you to set the level of protection to be adopted. See <a href="#">CONFIGURATION PROTECTION</a> chapter.
<b>tBAS</b>	Allows you to set the time base to be adopted by the programs, the Rate parameter and the timer: <b>min</b> The time intervals will be displayed in <b>minutes</b> . <b>SEC</b> The time intervals will be displayed in <b>seconds</b> . If you change this parameter, you will need to re-evaluate the configuration of the controller.
<b>SnH</b> Serial Number High	Displays the first 4 digits of the electronic serial number of the controller.
<b>SnL</b> Serial Number Low	Displays the last 4 digits of the electronic serial number of the controller.

## 6.8 MAP OF CYCLES AND PARAMETERS

OPERATION	CONFIGURATION MODE						
	CONTROL ACTION		ALARM	CONFIGURATION	PROGRAM	TIMER	RESTRICTED ACCESS
PV Indication	CF-1		CF-2	CF-3	CF-4	CF-5	CF-6
*	*		*	*	*	*	PRSS
Timer indication	CntY		FuR1	tYPE	Pr.tY	t.Str	CALib
SP	Pid	onoF	FuR2	FLtr	rAtE	ProG	inLC
t.uE	Atun	HYSt	SPR1	dPPo	rtEn	Pr.n	inHC
rAtE	Pb		SPR2	un t		P.SP0	rStr
run	ir		bLR1	oFFS		P.t1	PRSC
			bLR2	SPLL		PE1	Prot
			HYR1	SPHL		P.SP1	SnH
			HYR2	run		P.t2	SnL
	uaLL		A t1	rnEn		PE2	
	uaHL		A t2	bAud		P.SP2	
	SFS t		A2 t1	Pr.tY		P.t3	
		out1		Rddr		PE3	
		out2				P.SP3	
						P.t4	
						PE4	
						P.SP4	
						LP	

Table 5

\* The **PRSS** parameter is displayed as the first parameter of the cycle where the configuration degree starts.



## 7. CONFIGURATION PROTECTION

The controller has a protection function which, if configured, prevents improper changes to its configuration.

In **CF-9** (see [CF-6 – ACCESS TO RESTRICTED PARAMETERS](#) section), the **Protection Degree (Pr o t)** parameter allows you to define the cycles to be protected against changes:

PROTECTION DEGREE	
<b>6</b>	Only <b>CF-6</b> is protected.
<b>5-6</b>	Cycles <b>CF-5</b> and <b>6</b> are protected.
<b>4-6</b>	Cycles <b>CF-4</b> , <b>5</b> and <b>6</b> are protected.
<b>3-6</b>	Cycles <b>CF-3</b> , <b>4</b> , <b>5</b> and <b>6</b> are protected.
<b>2-6</b>	Cycles <b>CF-2</b> , <b>3</b> , <b>4</b> , <b>5</b> and <b>6</b> are protected.
<b>1-6</b>	Cycles <b>CF-1</b> , <b>2</b> , <b>3</b> , <b>4</b> , <b>5</b> and <b>6</b> are protected.
<b>ALL</b>	All cycles are protected.

Table 6

**CF-6** is always protected. To change its parameters, you must correctly enter the access password in the **PR55** parameter, which will be displayed when you access the protected cycle, as shown in the table above.

### 7.1 PASSWORD

When accessed, the protected cycles ask for a password which, if entered correctly, allows you to change the configuration of the parameters of these cycles.

The access is entered into the **PR55** parameter, which is displayed on the first parameter of the protected cycles. Without the protection password, the parameters of the protected cycles can only be viewed.

The access is defined in the **Password Change** parameter (**PR5L**), present in the **CF-6** cycle.

The equipment leaves the factory with the password **1111**.

### 7.2 PASSWORD PROTECTION

The controller features a security system that helps prevent numerous passwords from being entered to guess the correct one. When you enter an incorrect password 5 consecutive times, the equipment will prevent new attempts for 10 minutes.

### 7.3 MASTER PASSWORD

If you forget your password, you can use the Master Password. The master password allows you to change the **Password Change** parameter (**PR5L**) and set a new password for the controller.

The master password is composed of the last 3 digits of the serial number of the controller **plus** the number 9000.

**Example:** The master password for equipment with serial number 07154321 is 9321.

## 8. PID CONTROL

Controlling a process in **ON / OFF** mode is simple. When acting on the process, the controller is based on the value of the measured variable (PV) and the desired value for that variable (SP) and switches its outputs on or off so that PV reaches the value set in SP. In an industrial oven, for example, the measured temperature value (PV) will reach the desired value (SP) after some time. This technique, however, is not always the most efficient, as it occasionally involves too much energy consumption, oscillations in PV values and different time intervals than expected.

PID control, meanwhile, is a much more sophisticated and efficient control technique. Here, the controller not only uses PV and SP information to determine its action on the process, but also information on the physical characteristics of the process, such as its relationship with the applied energy and the environment in which it is inserted.

The process features are represented in the **Proportional Band**, **Integral Rate** and **Derivative Time** parameters, which constitute the PID Parameters.

In more sophisticated controllers, these parameters are calculated by the controller itself. The controller acts on the process in a special and temporary way, just to recognize the characteristics of the process and set the most appropriate values for the PID parameters.

The process of defining the PID parameters is known as **AUTO-TUNING**. In this process, the PID parameters are calculated automatically by the controller. This calculation can be carried out at the user's request or on the controller's own initiative, as the equipment realizes that the behavior of the process is not appropriate.

### 8.1 AUTO-TUNING

The **Atun** parameter, located in the **CF-1** cycle, displays the available Automatic Tuning options:

- **oFF**: Automatic Tuning is disabled.
- **FRSt**: When this option is selected, the controller performs Fast Auto-Tuning at the user's initiative. This option seeks to perform the tuning in the shortest possible time, but its calculation is not as precise as the **FULL** option discussed below.

Once the tuning process has finished, the PID parameters receive the calculated values and the **Atun** parameter returns to the **oFF** condition.

- **FULL**: When this option is selected, the controller performs Full Auto-Tuning at the user's initiative. This option seeks to perform the most precise tuning possible, using the necessary time interval.

Once the tuning process has finished, the PID parameters receive the calculated values and the **Atun** parameter returns to the **oFF** condition.

When running an Auto-Tuning (**FRSt** or **FULL**), the **AT** flag remains on. At the end of Tuning, the flag switches off permanently.

Throughout the Auto-Tuning process, the controller acts on the process in **ON / OFF Mode**. Large variations in PV can therefore occur and must be considered by the user beforehand. At the end of Tuning, the controller acts on the process in PID mode, adopting the calculated values.

### 8.2 SELF-ADAPTIVE MODE

The **FRSt** and **FULL** modes are the Auto-Tuning options available on the controller. They should be selected when the user is faced with a new and unknown process or when a known process does not perform as expected. In addition to the user, the controller itself can take the initiative to trigger an Auto-Tuning when faced with a process that does not perform as expected.

The **Self-Adaptive Mode** is the condition that allows the current process behavior information to be compared with other process behavior information (previously acquired) and used as a reference. If the current behavior of the process differs significantly from the reference behavior, a new tuning of the PID parameters will be performed, now on the controller's own initiative.

The **Atun** parameter, located in the **CF-1** cycle, displays the available Self-Adaptive mode options:

- **SELF**: When this option is selected, the controller will be placed in Self-Adaptive mode and the process performance will be continuously monitored. A **FULL** Auto-Tuning will be initiated by the controller (\*) as soon as the control is enabled (**run = YES**).

The **AT** flag will remain on during the tuning. At the end of this Tuning, the period in which the controller acquires the process reference information begins. During the reference information acquisition stage, the **AT** flag will flash slowly. At the end of this stage, the **AT** flag will turn off permanently and the controller will start acting on the process in PID Mode and in Self-Adaptive Mode.

As the behavior of the process deteriorates, a new Tuning will be triggered, and new references will be acquired.

The duration of the information acquisition stage is proportional to the response time of the process. After this, the controller can evaluate the performance of the process and determine whether a new Tuning is required.

It is not recommended to change the SP value or switch off the controller during the Tuning and Acquisition stages, as this may result in unsatisfactory process control performance.

(\*) If the controller still retains the process reference information, the initial **SELF** Tuning will not take place. The reference information will be erased when a **FRSt** or **FULL** tune is triggered by the user.

- **rSLF**: When this option is selected, the controller will trigger a **FULL** tune immediately. At the end of this tune, it will be placed in Self-Adaptive mode, changing the **Atun** parameter automatically to **SELF**.
- **EGHt**: Option with similar action to **SELF**. The controller will perform a **FULL** tune not only when the controller is enabled, but whenever a control reset occurs.

For PWM or pulse output, the quality of the tuning will also depend on the cycle time previously set by the user.

If tuning does not result in satisfactory control, the table below provides instructions on how to correct the behavior of the process:

PARAMETER	VERIFIED PROBLEM	SOLUTION
Proportional Band (P)	Slow response	Decrease
	Great oscillation	Increase
Integration Rate (I)	Slow response	Increase
	Great oscillation	Decrease
Derivative Time (D)	Slow response or instability	Decrease
	Great oscillation	Increase

Table 7

## 9. RAMPS AND SOAKS PROGRAM

This function allows you to create a behavioral profile for the process. Each program is composed of a set of up to 4 segments, called a RAMP AND SOAK PROGRAM, defined by SP values and time intervals.

It is possible to create up to 5 ramps and soaks programs. The figure below shows a sample program:

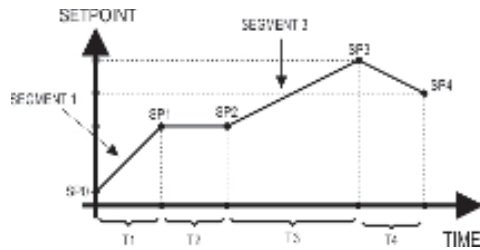

Figure 6

When you define the program and run it, the controller starts to generate the SP according to the program.

To run a program with fewer than 4 segments, simply program 0 for the time of the segment following the last desired segment.

The program tolerance function **Ptol** defines the maximum deviation between PV and SP during program execution. If this deviation is exceeded, the time count will be interrupted until the deviation is within the programmed tolerance (giving priority to the SP).

If you program 0 in tolerance, the controller will execute the defined program without considering any deviations between PV and SP (giving priority to time).

The configurable **time limit** for each segment is 5999 and can be displayed in either seconds or minutes, according to the time base defined.



The controller adopts a single time base for both the programs and the timer. In parameter **LBRS**, available in the Calibration cycle (CF-6), it can be set to seconds or minutes.

When you change the time unit, the time unit of ALL programs will change. The time interval parameters set in the Timer cycle (CF-5) will also be affected.

### 9.1 PROGRAM RESTORE AFTER POWER FAILURE

Function that defines the behavior of the controller when returning from a power failure while running a program of ramps and soaks. The options are:

- Prog** Returns to the beginning of the program.
- PSEG** Returns to the beginning of the segment.
- lSEG** Returns to the exact point in the program segment before the power failure (\*).
- oFF** Returns with the control disabled (**run = no**).

(\*) In the **Resume at exact point (lSEG)** option, you must consider uncertainties of up to 1 minute between the segment time at the time of the power failure and the segment time adopted when resuming program execution when the power returns.

The action of the **lSEG** option is related to the configuration adopted in the **Ptol** parameter. It also has the following features:

1. With **Ptol** set to 0, the controller resumes program execution immediately after the power returns, from the point and segment where it stopped, regardless of the PV value at that time.
2. With **Ptol** other than 0, the controller waits until PV enters the deviation range defined by the value of **Ptol** and then resumes program execution.

### 9.2 PROGRAM LINK

It is possible to create a large, more complex program with up to 20 segments, linking the 5 programs. Thus, when one program finishes running, the controller will immediately start running another.

When you create a program, you define on the **LP** screen whether there will be a link to another program.

For the controller to continuously run a given program or programs, simply connect a program to itself or the last program to the first one.

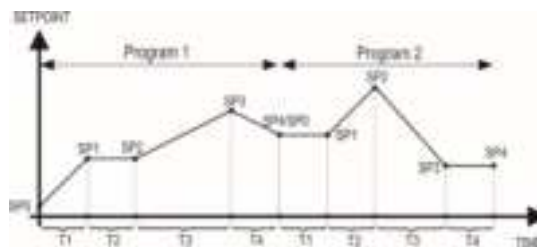

Figure 7

## 10. MAINTENANCE

### 9.1 PROBLEMS WITH THE CONTROLLER

Connection errors and improper programming represent most problems encountered when using the controller. A final review can prevent wasted time and damage.

The controller displays some messages to help you identify problems.

MESSAGE	PROBLEM DESCRIPTION
----	Open input. No sensor or signal.
<b>Err 1</b> <b>Err 6</b>	Connection and/or configuration problems. Check the connections and configuration.

Table 8

Other error messages displayed by the controller represent internal damage that necessarily means the device must be sent for maintenance.

### 9.2 INPUT CALIBRATION

All input types are already calibrated at the factory. Recalibration is not recommended for inexperienced operators.

If recalibration is necessary, proceed as described below:

1. Select the input type to be calibrated.
2. Access **CF-6** cycle.
3. At the input of the controller, apply a signal close to the lower limit of the input.
4. In the **inLC** parameter, set the indicated value for the corresponding applied signal.
5. At the input of the controller, apply a signal close to the upper limit of the input.
6. In the **inHC** parameter, set the indicated value for the corresponding applied signal.
7. Return to the measurement screen and validate the calibration.

**Note:** When checking or calibrating the controller, check that the Pt100 excitation current required by the simulator or calibrator is compatible with the Pt100 excitation current used in this instrument: 0.170 mA.

## 11. SPECIFICATIONS

**DIMENSIONS:** ..... 26 x 49 x 108.3 mm (1/32 DIN)  
Panel cutout: ..... 22.5 x 45.5 mm ( $\pm 0.5$  mm)  
Approximated weight: ..... 75 g

### POWER SUPPLY:

Standard model: ..... 100 to 240 Vac/dc ( $\pm 10$  %), 50/60 Hz  
24 V Model: ..... 12 to 24 Vdc / 24 Vac ( $-10$  % /  $+20$  %)  
Maximum consumption: ..... 5 VA

### ENVIRONMENTAL CONDITIONS:

Operating temperature: ..... 0 to 50 C°  
Relative humidity: ..... 80 % max.

**INPUT:** ..... Thermocouples, Pt100, and voltage (according to **Table 1**)

Internal resolution: ..... 32767 levels (15 bits)  
Display resolution: ..... 12000 levels (from -1999 to 9999)  
Input reading rate: ..... up to 55 per second  
Accuracy: ..... Thermocouples **J, K, T, E**: 0.25 % of span  $\pm 1$  °C  
..... Thermocouples **N, R, S, B**: 0.25 % of span  $\pm 3$  °C  
..... **Pt100**: 0.2 % of span  
..... **mV**: 0.1 %

Input impedance: ..... Pt100 and thermocouples: > 10 M $\Omega$

Pt100 measurement: ..... 3-wire type, ( $\alpha = 0.00385$ )

With cable length compensation, excitation current of 0.170 mA.

All input types are factory calibrated. Thermocouples according to NBR 12771/99; Pt100 NBR 13773/97.

### OUTPUTS:

OUT1: ..... Voltage pulse; 5 V / 25 mA

OUT2: ..... SPST Relay, 1.5 A / 240 Vac / 30 Vdc

**FRONT PANEL:** ..... IP65, Polycarbonate (PC) UL94 V-2

**HOUSING:** ..... IP30, ABS+PC UL94 V-0

**ELECTRICAL COMPATIBILITY:** ..... EN 61326-1:1997 and EN 61326-1/A1:1998

**EMISSION:** ..... CISPR11/EN55011

**IMMUNITY:** ..... EN61000-4-2, EN61000-4-3, EN61000-4-4, EN61000-4-5, EN61000-4-6, EN61000-4-8 and EN61000-4-11

**SAFETY:** ..... EN61010-1:1993 and EN61010-1/A2:1995 (UL file E300526)

**USB 2.0 INTERFACE, CDC CLASS (VIRTUAL SERIAL PORT), USB C CONNECTOR, MODBUS RTU PROTOCOL.**

**CONNECTIONS SUITABLE FOR PIN TERMINALS. SUITABLE ELECTRIC WIRE: 0.34 ~ 1.5 mm<sup>2</sup> (28 ~16 AWG)**

**PROGRAMMABLE PWM CYCLE FROM 0.5 TO 100 SECONDS.**

**STARTUP: 3 SECONDS AFTER POWER UP.**

**CERTIFICATIONS: CE, UL.**

**RoHS COMPLIANCE.**

## 12. IDENTIFICATION

N1020	- A	- B	- C
-------	-----	-----	-----

**A Available outputs:**

**PR:** OUT1 = Pulse / OUT2 = Relay

**B Available communication:**

**485** RS485 serial communication interface

**C Power supply:**

**Blank** Standard model = 100~240 Vac/dc; 50~60 Hz

**24 V** 24 V Model = 12~24 Vdc / 24 Vac; 50~60 Hz

## 13. WARRANTY

Warranty conditions are available on our website [www.novusautomation.com/warranty](http://www.novusautomation.com/warranty).