

# Sliding Gate Opener User's Manual

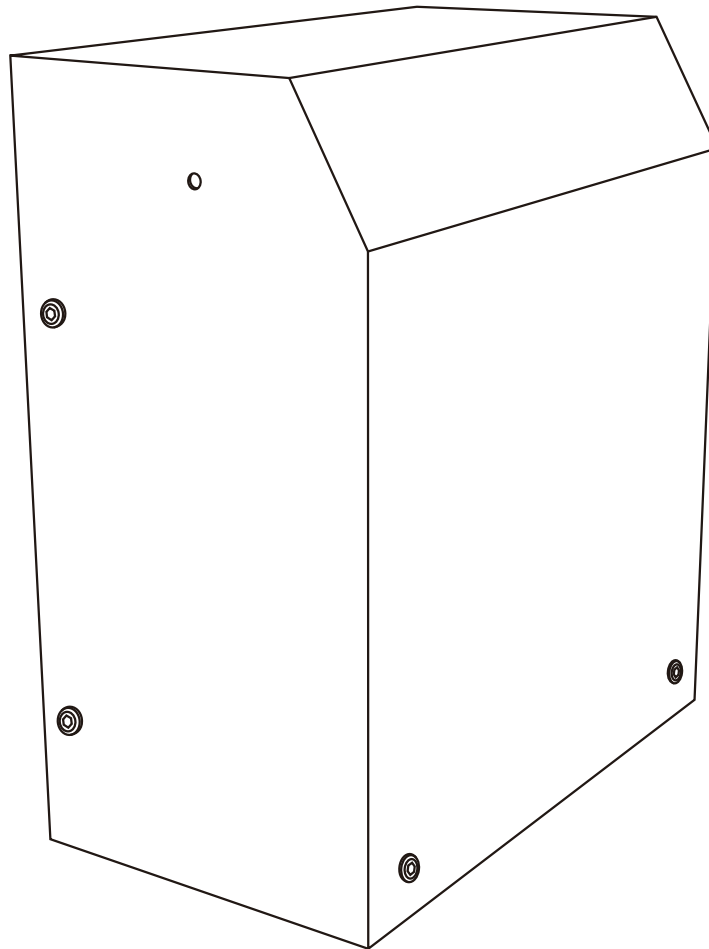

- ◆ Thank you for purchasing the sliding gate opener.
- ◆ Please read and follow all warnings, precautions and instructions before installation and using.
- ◆ Periodic checks of the opener are required to ensure safe operation.
- ◆ Keep the manual for future reference

# Contents

<b>1.General safety</b>	<b>1</b>
<b>2.Product description</b>	<b>2</b>
2.1 Part list	2
2.2 Optional accessories parts list	3
2.3 Technical specifications	3
<b>3.Installation overview</b>	<b>4</b>
3.1 Gate opening default setting information	(4)
3.2 Install the motor	(4)
<b>4.Connection of the power supply</b>	<b>7</b>
<b>5.Control board instruction</b>	<b>7</b>
5.1 Terminal and buttons instruction	(7)
5.2 LED indicator	(8)
5.3 Control board wire diagram	(8)
<b>6.How to program or erase the remote</b>	<b>10</b>
<b>7.How to use the remote to operate your gate opener</b>	<b>11</b>
<b>8.Control board function description</b>	<b>11</b>
<b>9.Control board digital display menu setting</b>	<b>14</b>
<b>10. Smart module instruction</b>	<b>18</b>
Add the device	(18)
Share the device	(20)
Remote assistance	(21)
Add USB card / RF remote control off/at site	(22)
Management of the USB card and RF remote control	(23)
Binding with camera	(23)

# CHECK YOUR GATE

Before installation, please make sure that the gate itself can be opened and closed smoothly & freely BY HAND WITHOUT THE GATE OPENER.

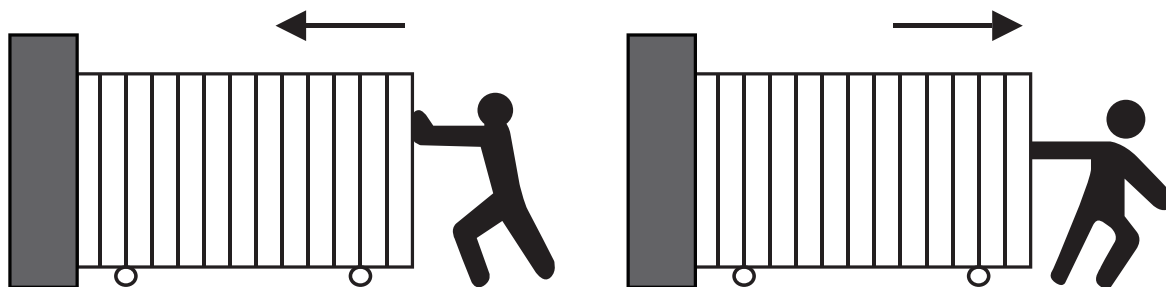

## 1. General safety



**WARNING!** An incorrect installation or improper use of the product can cause damage to persons, animals or properties, should always request the assistance of qualified personnel.

- This product was exclusively designed and manufactured for the use specified in the present documentation. Any other use not specified in this documentation could damage the product and be dangerous.
- The factory declines all responsibility for any consequences resulting from improper use of the product, or use which is different from that expected and specified in the present documentation.
- Do not install the product in explosive atmosphere or where there is any danger of flooding.
- To AVOID damaging gas, power, or other underground utility lines, contact underground utility locating companies BEFORE digging.
- Disconnect the electrical power supply before carrying out any work on the installation or maintenance.
- Please ensure that the using power voltage matches with the supply voltage of gate opener (AC220V±10% 50Hz ).
- To ensure safety, before installing the motor, all potential hazards and exposed pinch points of the gate must be eliminated or guarded prior, and make sure Gate End Stop and a Gate Stopper mounted at each end of the rail to prevent the gate travelling off the track.
- Never mount any device that operates the gate motor where the user can reach over, under, around or through the gate to operate the controls. These must be placed at least 1.8m from any moving part of the moving gate.
- Keep remote control and other control devices out of children's reach, in order to avoid unintentional activation.
- If required, install infrared photocells ( sold separately) to detect obstructions and prevent injury or damage.
- Instruct all users about the control systems provided and the manual opening operation in case of emergency.
- Anything which is not expressly provided for in these instructions is not allowed and will void warranty.
- Only use original parts for any maintenance or repair operation. We decline all responsibility with respect to the automation safety and correct operation when other supplier's components are used.

## 2. Product description

The PYM-D220G motor was designed as a device for moving sliding gates. The way of the gear works prevents the gate from moving when the motor is turned off, so there is no need to use an electric lock. Avoid a power failure, user can use the override key to unlock the clutch to manual open or close the gate.

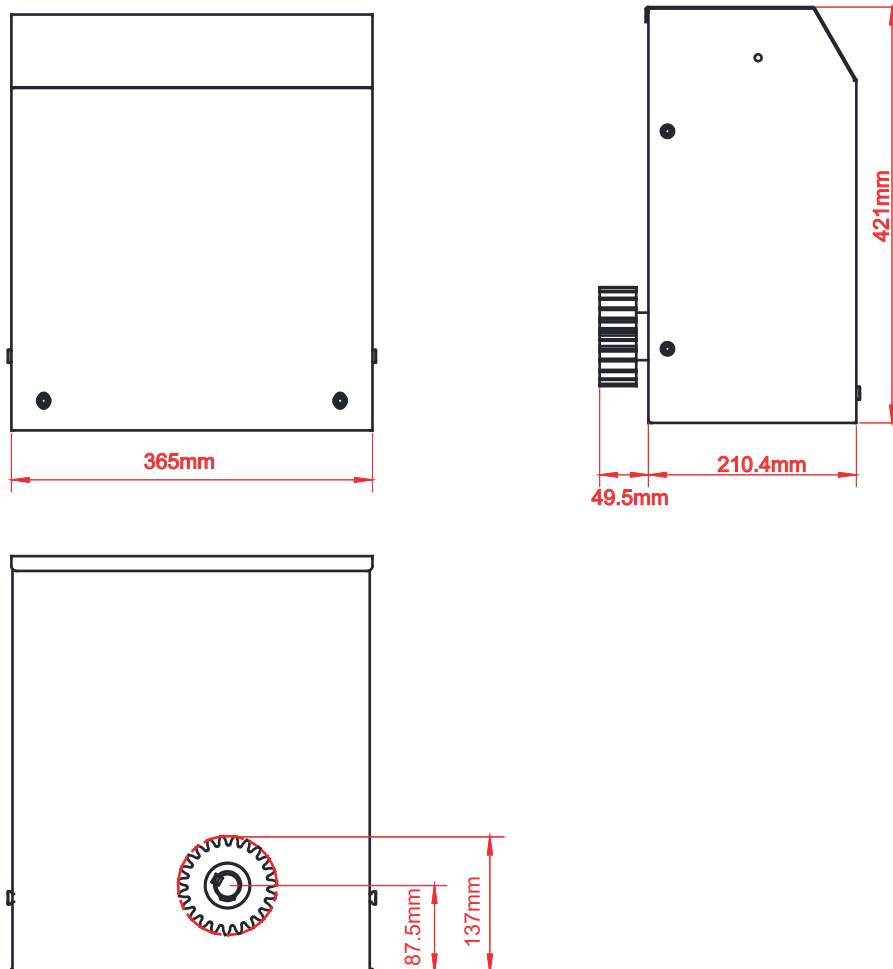

### 2.1 Part list

Diagram 1

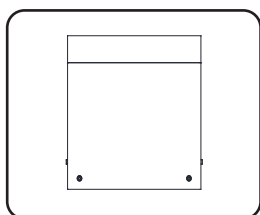

Motorx1

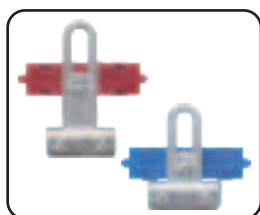

RHS/LHS Limit Switch  
Striker Plate x2

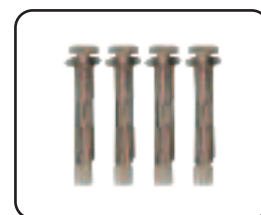

Motor to mounting  
plate screws x4



Striker Plate  
Fixing Bolts x4

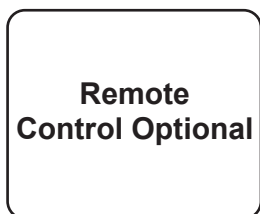

Remote  
Control Optional

Remotex2



Override keys x2

## 2.2 Optional accessories parts list (available at giant store)

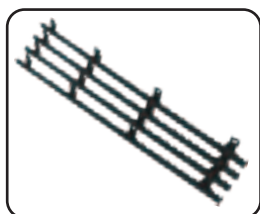

**Gear Rack**



**Photocell Sensor**



**Flash Lamp**



**TKM-01**



**Wifi controller**

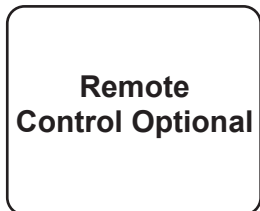

**Remote Control Optional**



**ST-01/02/03**



**Smartphone Remote Control with Camera**

## 2.3 Technical specifications

Power supply	AC 220V
Motor power	AC 220V
Maximum load	3000KGS
Rated power	550W
Rated speed	1400RPM
Output Speed	50Rr/min±10%
Running speed	25cm/s
Output torque	90 N.m
Output gear module	M=4
Output gear number	Z=23
Remote control distance	≤50 meter
Working humidity	≤85%
Maximum pull	3300N
Noise	≤55dB
Protection Class	B
Working temperature of motor	-20°C ~ +55°C
Packing	In a standard carton

## Features of sliding gate opener

- Soft start and slow stop.
- Automatic closing function adjustable from 0 to 99 seconds.
- Thermal protection against engine overheating.
- Anti-pinch protection in case of meeting an obstacle.
- Signaling the current operating status of the machine on the display.
- Ability to support up to 128pcs remote controls.
- Possibility to connect external buttons and control devices (e.g.push button, wifi controller, radio receiver etc).
- Possibility of partial opening of the gate, without the need to perform the full scope of work.
- Manual release of the gate in the event of a lack of 220V mains voltage.
- Add smart module for 2.4G bluetooth control (optional).

### 3. Installation overview

#### 3.1 Gate opening default setting information

The gate motor will open the gate to the right-hand side as its default setting (Refer to diagram 2).

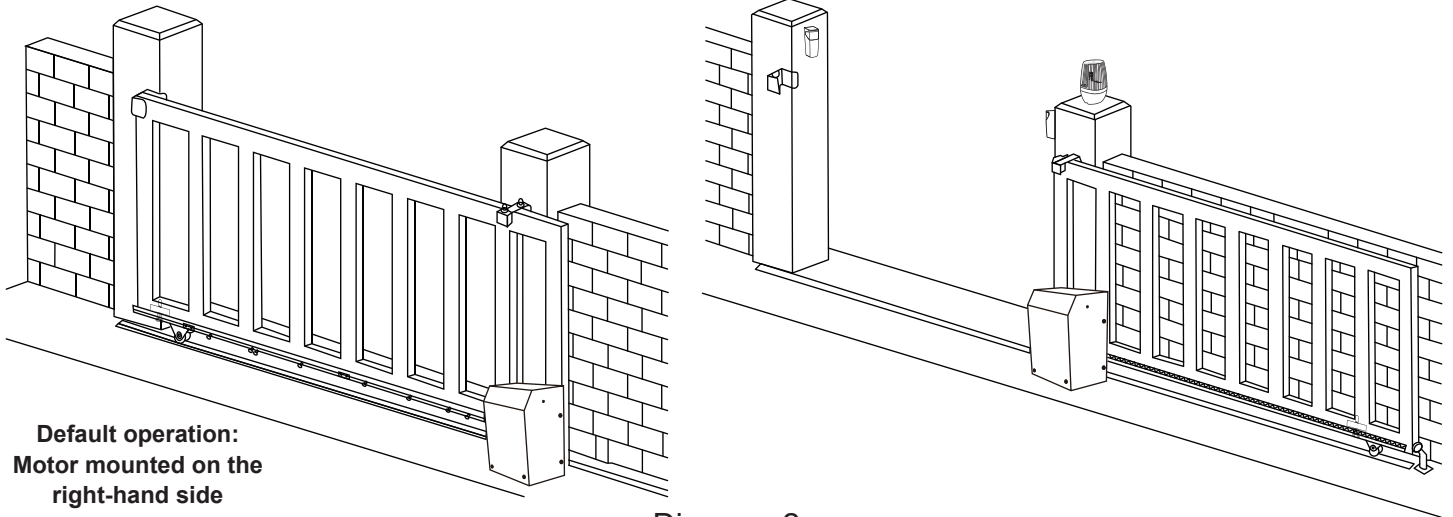
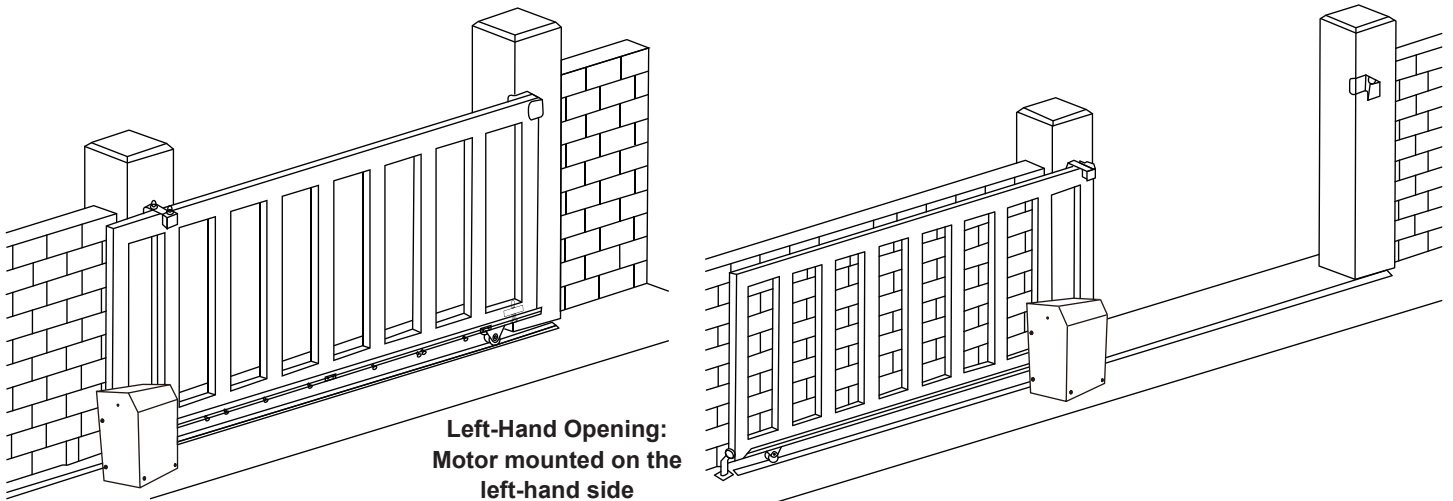

Diagram 2

Please note: Our factory setting is install motor on the right-hand of gate! When you want to install motor on the left-hand of gate, please enter the digital display menu to set the parameter J2 value from 0 to 1.



Any works done to the motor motor must be completed while the power is off, and the motor is unplugged.

Diagram 3

#### 3.2 Install the motor

##### • Installation of motor base plate

1. Depending on the installation size of the motor and mounting height of racks, after determine the installation position of the motor base plate, first let the bolt embedded or use expansion bolt to make base plate fixed on watering good cement foundation. See diagram 4.

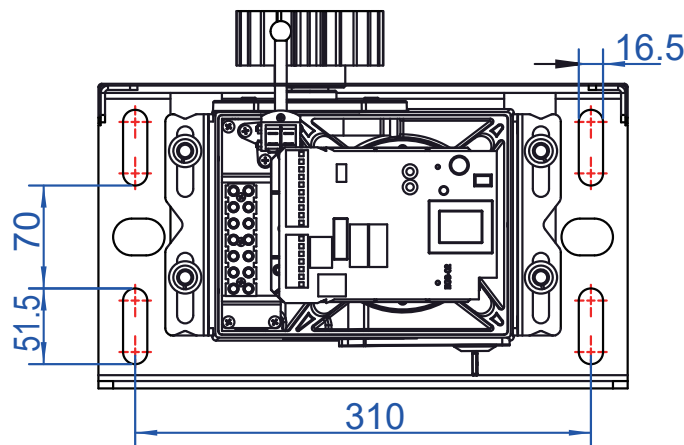

Diagram 4

2. If gear rack has been installed on door, motor can be fixed on it, use a allen key rotation to clutch "off" position, after motor gear and gear rack match well to determine position of base plate, then remove motor and fix base plate.

● **Installation of gate opener**

1. Put gate opener on base plate, use a random matching hexagon screw make the motor fixed on the base plate.
2. Unscrew the screws fixed the motors cover, remove motor cover. According electrical wiring diagram, connected power cord, after adjust in good position, then install cover and use screws to fixed it.

● **Preparing for gear racks installation**

Using the supplied override key unlock the clutch and pull out manual override lever (see diagram 5) then manually close the gate.

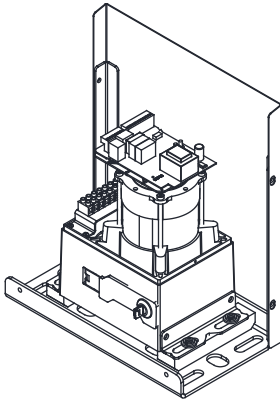

Insert Key, rotate 90 degrees

Diagram 5

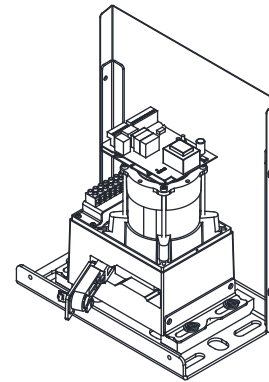

Releasing arm in torsion, wriggle 90 degrees gate operator will be in releasing state

● **Install the gear rack on the gate**

Each piece of rack will interlock into the next piece (see diagram 6).

The best method for installation is to first close the gate using the manual override, sit the first piece on the gear of the motor (make sure it is 100% level first) then fix directly to the gate in the centre of the fixing hole of the rack. Now loosen the fixing and adjust the spacing between the motor gear and the gear rack (allow 2-3mm gap)

Re-tighten and fix the next remaining holes on the rack.

Move the gate manually forward and backward along the installed rack to ensure that the gap between the rack and the gear is consistent throughout.

Clip in the next piece of rack into the first (make sure it is 100% level first) then fix directly to the gate in the centre of the fixing hole of the rack.

Again move the gate manually forward and backward along the installed racks to ensure that the gap between the rack and the gear is consistent throughout. Repeat the above method to complete the racks installation and always be sure to move the gate manually forward and backward every time you install another piece of the rack.

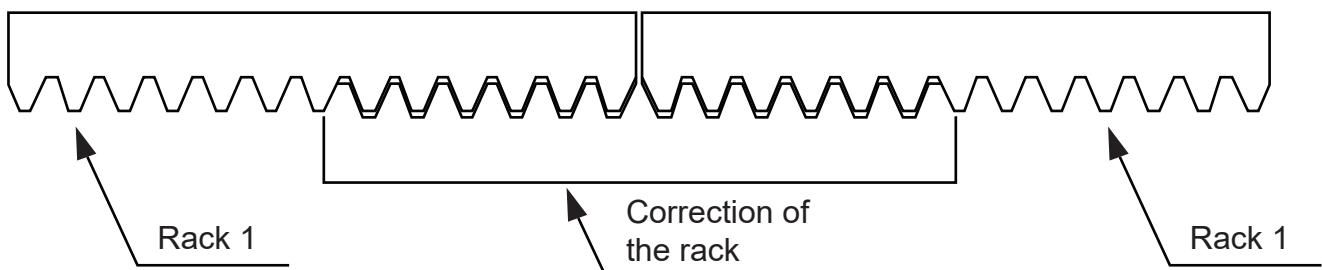

Diagram 6

● **Installation of limit magnet**

here are 2 limit magnet supplied. Note there is a left hand and a right hand magnet. The magnet should be installed one at either end of the rack. See Diagram 7

To install the magnet in the correct position, open the clutch door and press the 'CLOSE' button on the remote, the motor will run but will not drive the gate. Close the gate manually and adjust the limit magnet to contact the toggle switch and switch the motor off at the desired gate position. To adjust the stop position of the gate when it is open, press the 'OPEN' button, manually open the gate and adjust the other limit magnet to contact the toggle switch and switch the motor off.

When you are satisfied the limit magnet are in the correct positions, tighten the screws in the limit magnet to clamp them to the rack, close the clutch door and using the remote control check the gate opens and closes to the desired positions. Adjust the limit magnet if necessary.

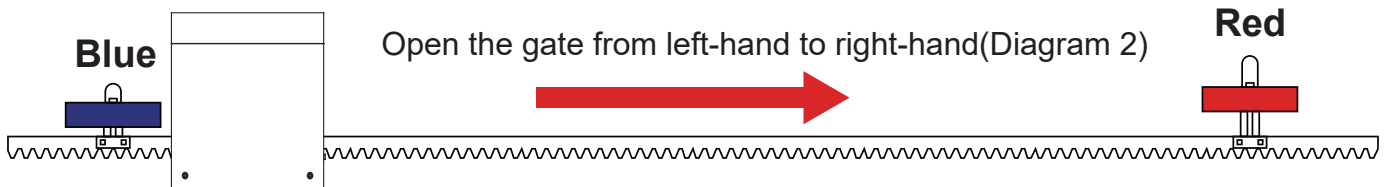

If you install the motor on the left of the gate, please adjust the blue and red limit magnet position as below picture show.

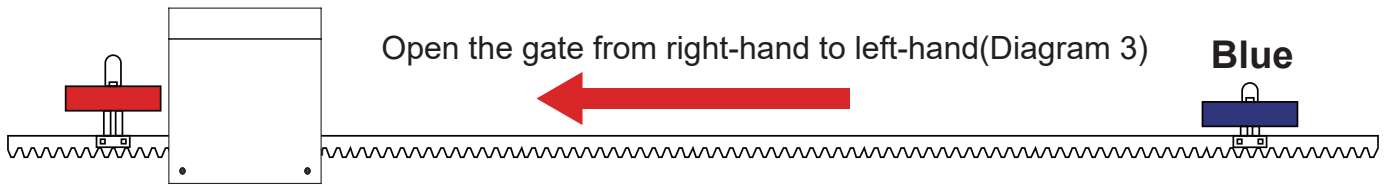

Diagram 7

● **Typical installation layout:**

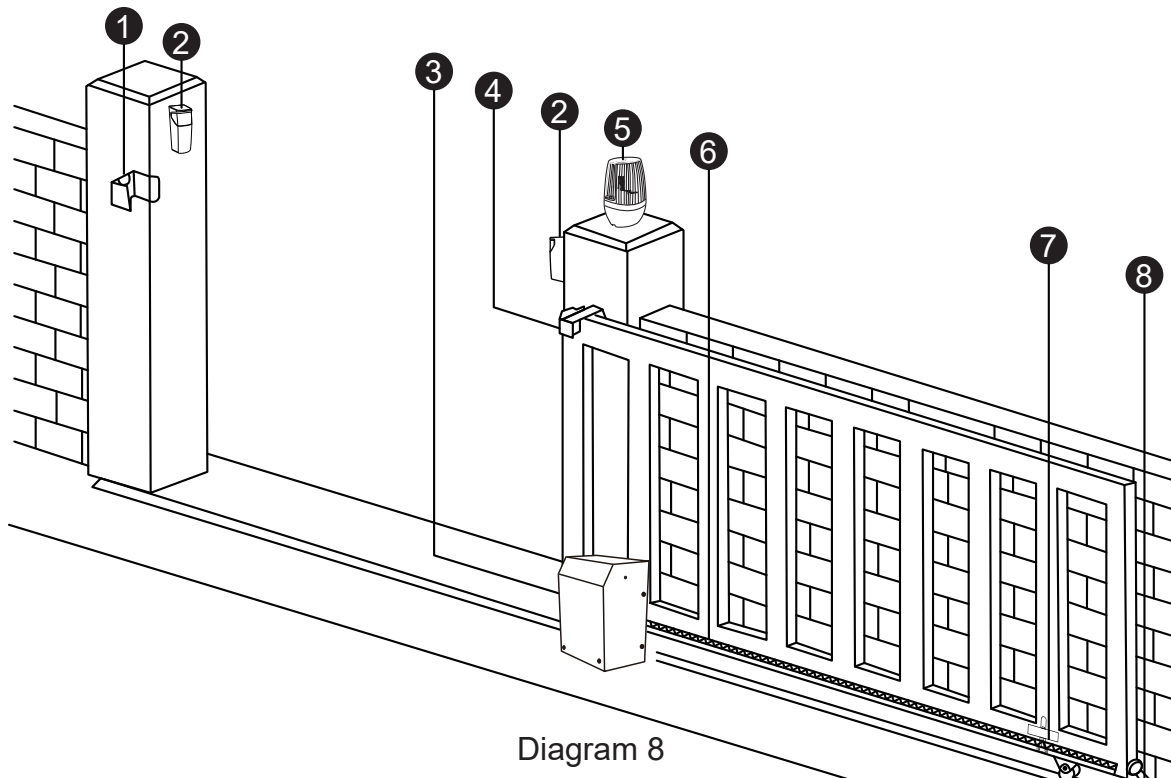

Diagram 8

- |                           |                              |                       |
|---------------------------|------------------------------|-----------------------|
| ① Gate catch(optional)    | ② Photocell sensor(optional) | ③ Gate motor          |
| ④ Guide bracket(optional) | ⑤ Flash lamp(optional)       | ⑥ Gear rack(optional) |
| ⑦ Magnet limit switch     | ⑧ Gate stopper(optional)     |                       |



## 4. Connection of the power supply

**⚠ WARNING! NEVER** connect the gate opener to the power outlet before all the installations have been done.

**Only use the AC electricity as the power source**

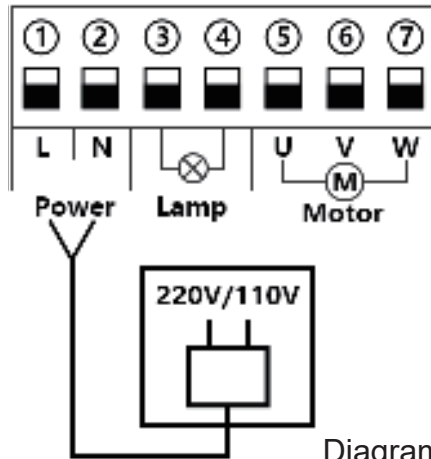

Diagram 8

## 5. Control board instruction

Technical Parameters

1. Power supply: AC 220V
2. Power: 250W
3. Application: AC three phase asynchronous sliding gate opener
4. Remote control: Giant customized rolling code
5. Remote control memory: max support 128pcs

**Note:** After user turned off the power for the control board, due to the existence of the large capacitance of the board, there will be residual power, please do not touch the exposed wires of the board directly.

### 5.1 Terminal and buttons instruction

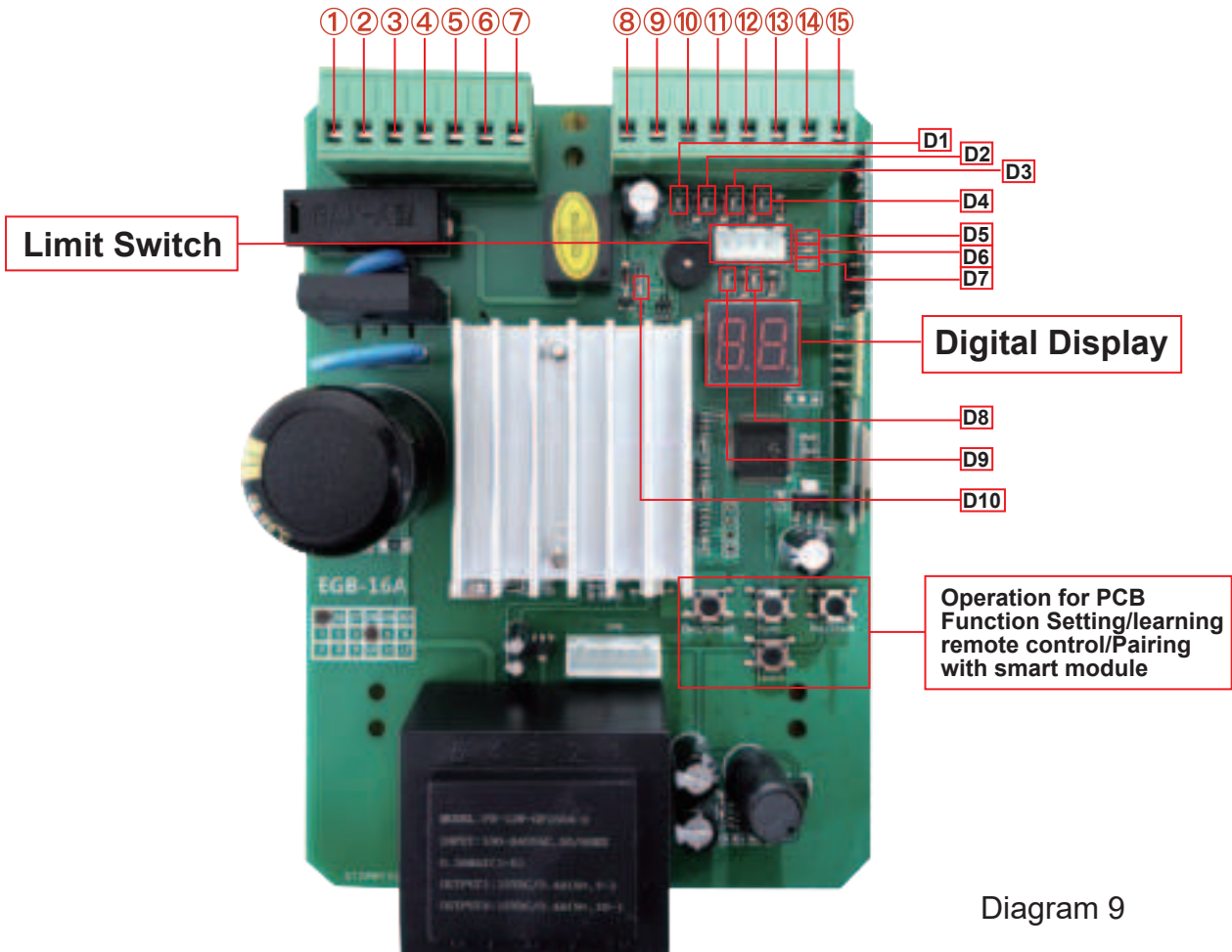

Diagram 9

The following functions refer to the picture control board layout.

1&2. Power: used for connecting with AC 220V power supply.

3&4. Lamp: used for connecting with flashing light, output voltage is AC 220V.

5&6&7. Motor: used for connecting with sliding gate motor's wire.

8.VCC: DC 12V output used for connecting with external devices, max 100mA.

9.COM: used for connecting with COM terminal or GND.

10.Ph: used for connecting with the photocell sensor.

11.Start: It is a single button control mode switch for controlling the gate by "open - stop - close - stop - open" cycle.

12.COM: used for connecting with COM terminal or GND.

13.Close: used for connecting with any external devices that will operate to close the gate.

14.Open: used for connecting with any external devices that will operate to open the gate.

15.ANT: antenna connection.

16.LEARN: It is for programming/removing the remote control.

17.DEC/SMART: It is for figure decreasing of setting the data and add intelligent device.

18.FUN: Used for enter the menu setting and confirm the data.

19.INC/START: It is for figure increasing of setting the data and setting the single button control mode.

## 5.2 LED indicator

**D1:** The photocell sensors output signal instructions

LED ON(Blue): Photocell sensors detection,if there have obstacle when closed the gate, the motor will stop running. LED OFF: Photocell sensors detection, there is no obstacle.

**D2:** LED ON(Blue): Trigger the start terminal.

**D3:** LED ON(Blue): Trigger the close terminal.

**D4:** LED ON(Blue): Trigger the open terminal.

**D5:** Indicate for operation of smart module

**D6:** LED ON: the board with power on

**D7:** Indicate for learning/Delete remote control

**D8:** Limit switch of closing the gate.

LED ON: The gate is not completely closed. LED OFF: The gate is completely closed

**D9:** Limit switch of opening the gate.

LED ON: The gate is completely opened. LED OFF: The gate is not completely opened

**D10:** Warning light on flashing.

## 5.3 Control board wire diagram

### • Install the motor in the right side of gate

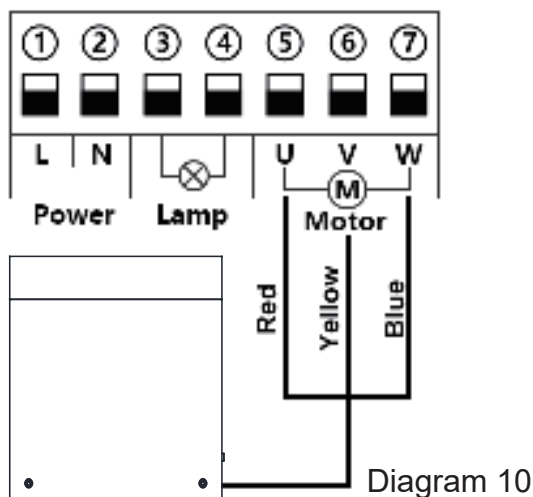

Terminal ⑤ , ⑥ and ⑦ is for connecting with the motor.

When you want to install motor on the left-hand of gate, please enter the digital display menu to set the parameter J2 value from 0 to 1.

- **Connect with flash lamp**

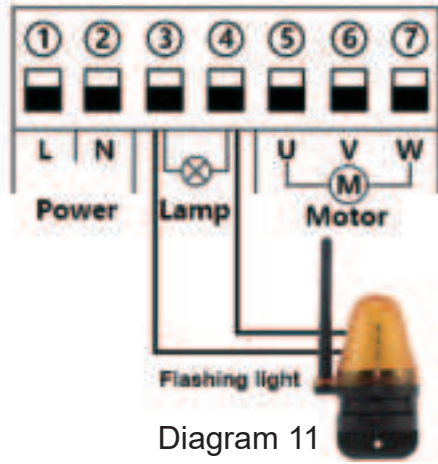

Terminal ③ and ④ is for connecting with the flash lamp .

- **Connect with photocell sensor**

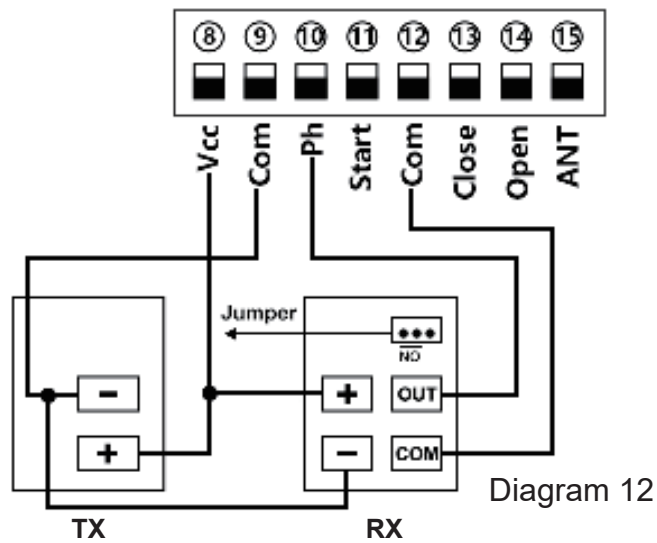

Connect terminal ⑩ with the “COM “ of photocell RX.  
 Connect terminal ⑩ with the “OUT “ of photocell RX.  
 Connect terminal ⑧ with the “+ “ of photocell RX and TX.  
 Connect terminal ⑨ with the “- “ of photocell RX and TX.

- **Connect with start terminal**

Start terminal is used for connecting with some external devices , such push button, wired keypad, receiver etc.  
 Control gate by “ open-stop-close-stop-open ” mode

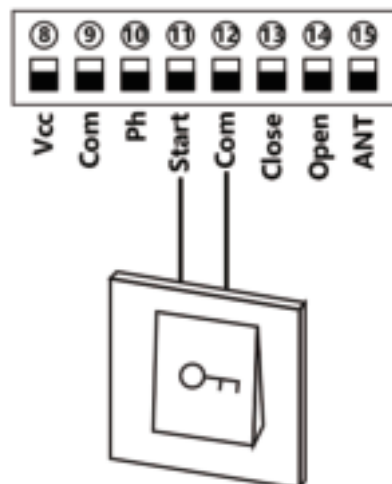

Terminal ⑩ and ⑩ is for connecting with the push button.

Note! If you connect the wired keypad, etc devices, please also connect with ⑧ Vcc and ⑨ Com to get the power supply.

- **Connect with open/close gate device**

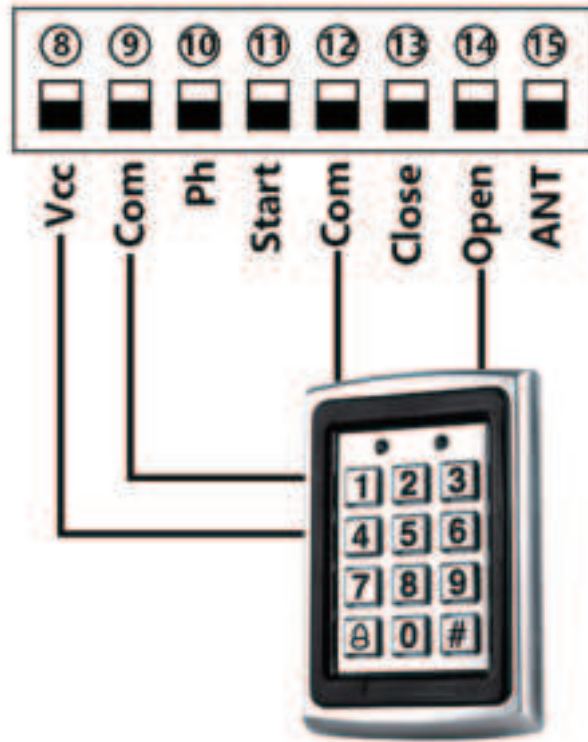

**Open gate device:**

Terminal ⑧ and ⑨ is for supplying the power to the push button.

Terminal ⑫ and ⑭ is for connecting with the device.

**Close gate device:**

Terminal ⑧ and ⑨ is for supplying the power to the push button.

Terminal ⑫ and ⑭ is for connecting with the device.

**6.How to program or erase the remote**

- Program the remote: Press learn button for at least 1 second and then release, the LED indicator will light on. Now user needs to press the button on the remote control, with the buzzer short beep, which means the code learning is successful, the digital LED will show the quantity of that remotes were learned.

After the user presses the learn button, within 8 seconds, if the controller doesn't receive the signal from the remote, the controller's LED indicator will turn out and exit the code learning statute.

Note: Due to the digital display only can show two digital numbers, if the controller already learned more than 99pcs remote, from the 100th remote, the digital display will show A to replace the ten and hundred digits. Such as the 100th remote will show A0, and the 101st remote will show A1. If the controller already learned more than 109pcs remote, from the 110th remote, the digital display will show b to replace the ten and hundred digits. Such as the 110th remote will show b0. And the 120th remote will show C0.

Max capacity: 128pcs remote. If the digital display show "- -" with a buzzer short beep 5 times, then means can not learn more remotes.

- Erase the remote: Press and hold the learning button for 5 seconds, while the user hears the buzzer with a long beep, release the button, and the digital display show "00". Now all remotes can not control the gate.

## 7. How to use the remote to operate your gate opener

Each remote has 4 buttons, can set them with different work mode independently through the digital display menu L1, L2, L3 and L4,

0: No function.

1: Open-Stop-Close...

2: Pedestrian mode

3: Open only.

4: Close only.

5: Stop only.

6: Turn auto close off via remote.

## 8. Control board function description

Item	Description
Power on	After the control board powered on, the buzzer will sound, and the digital display will show model number and version, and the status indicator LED lit up.
Auto travel learning	<p>The newly installed motor needs to operate the auto travel learning once before the high and low speeds can be normally allocated.</p> <p>After the auto travel learning completed, the gate motor will automatically allocated the high and slow speed. The high and slow speeds for opening and closing can be set through the digital display menu.</p> <ol style="list-style-type: none"> <li>1. Before starting the auto travel learning, the gate must be fully closed.</li> <li>2. Enter the menu, select Pr, set 5, and confirm to start the auto travel learning.</li> <li>3. The gate will automatically open and close with slow speed to remember the travel time.</li> <li>4. The speed of slow speed for opening and closing separately through the menu. The larger the value, the more slow speed.</li> <li>5. During the auto travel learning process, if any control occurs, such as RF control, Pedestrian terminal trigger, safety beam trigger, etc., the auto travel learning will be interrupted and the learning operation needs to be restarted. If the auto travel learning fails halfway, the buzzer will sound twice, and the learning will be long once if the learning is successful.</li> </ol> <p>Note: If Pr is set to 10, you can also enter the auto travel learning, but at this time it will run with the high speed set in the menu. It is recommended to select 5 to use the slow speed to learn the travel. After the slow speed auto travel learning, if you found that the high and slow speed</p>
Setting slow speed running time	After completed the auto-travel learning, the gate opener will automatic set the slow speed running time for opening and closing from 0 - 5 levels. The bigger the value is, the more slow speed running time. 0 means No slow speed running time.
Setting running speed for opening and closing	The gate opener can set the high speed and slow speed for opening and closing from 0 - 5 levels. The bigger the value is, the higher speed running time. If adjust the running speed, please operate the auto-travel learning again.
Overcurrent	<p>The overcurrent function can achieve an anti-smashing car. While the gate is opening, it detects the overcurrent and stop. If the gate is closing and detects the overcurrent, the user can set different response modes through the menu A9.</p> <ol style="list-style-type: none"> <li>0: reverse back to the opened position.</li> <li>1: reverse to open the gate for 1 second.</li> <li>2: 1: reverse to open the gate for 3 seconds.</li> <li>3: stop.</li> </ol> <p>Setting overcurrent for opening and closing the gate through the digital display menu.</p>

Limit switch mode	<ol style="list-style-type: none"> <li>1. When the gate is fully opened/closed, and trigger the limit switch, the motor will auto stop.</li> <li>2. The control board support to work with NO and NC limit switch, and can set the limit switch mode of NO and NC mode through the digital display menu.</li> <li>3. The control board can switch the limit direction through the digital display menu. When the digital display show “Lr” means the limit switch detect a bug (limit error). Please check whether the limiter is damaged or in poor contact, or whether the normally open and normally closed mode (menu F0) set by the system does not match the actual limit switchtype.</li> </ol>
Safety beam mode	<p>The safety beam mode can be selected by menu F2, the default mode is 1, it is normal open mode.</p> <ol style="list-style-type: none"> <li>1. While the gate is closing, if the infrared signal meets an obstruction, the gate will rebound to open.</li> <li>2. If set the auto-closing timer after fully opening, the gate will be auto-closed.</li> <li>3. If the safety beam signal exists, the gate closing action will not be executed and the countdown time will always be reset.</li> </ol>
Auto-closing timer for fully opening	<ol style="list-style-type: none"> <li>1. The auto-closing function is only triggered after the gate is fully opened.</li> <li>2. Auto close timer for fully opening can be set through the digital display menu.</li> <li>3. When auto-close timer start to countdown, the STATE LED will flash one time each second.</li> <li>4. The remote button can set to cancel the auto-closing command once.</li> <li>5. Note: Cancellation only cancels this time, and the gate can be auto-closing next time when it is fully opened.</li> </ol>
Flash Lamp Mode	<p>The digital display menu can set the lamp work mode.</p> <p>Mode 0: Flashing light and motor will operate and stop at the same time.</p> <p>Mode 1: Flashing light will turn off 30 seconds after the motor stop.</p> <p>NOTE: No matter you choose the mode 0 or mode 1, when the gate is on the auto close timer countdown statue, the lamp also will light on.</p>
Motor protection	<p>As soon as the motor runs continuously for more than the 120s, the motor will automatically stop working to protect the motor.</p>
Setting of start terminal	<p>The start terminal can be setting with different function through the digital display menu.</p> <p>0: Fully Open-Stop-Close.....(factory default)</p> <p>1: Pedestrian Open-Stop-Close.</p> <p>2: Open only.</p> <p>3: Close only.</p> <p>4: Stop only.</p>
Setting of open terminal	<p>The open terminal can be setting with different function through the digital display menu.</p> <p>0: Fully Open-Stop-Close.....</p> <p>1: Pedestrian Open-Stop-Close.</p> <p>2: Open only.(factory default).</p> <p>3: Close only.</p> <p>4: Stop only.</p>

Setting of close terminal	<p>The close terminal can be setting with different function through the digital display menu.</p> <p>0: Fully Open-Stop-Close.....</p> <p>1: Pedestrian Open-Stop-Close.</p> <p>2: Open only.</p> <p>3: Close only.(factory default)</p> <p>4: Stop only.</p>
Pedestrian mode	<p>The remote button and Pedestrian terminal can trigger the Pedestrian mode, the gate will partially open then stop, not fully open. This mode is convenient for users walking in and out. The pedestrian mode work with “ open-stop-close-stop...”</p> <p>The auto-closing timer after Pedestrian mode can set through the digital display menu.</p>
Upgrade control board system by USB device	<ol style="list-style-type: none"> <li>1.Before you upgrade the system, please confirm the U disk document is FAT32 or not. If not, please format the U disk as FAT32.</li> <li>2.Copy the upgrade file into the root directory of the U disk and name it EGB-16A.bin.</li> <li>3. Insert the U disk into the upgrade module, and then connect the upgrade module to the USB port.</li> <li>4. Enter the menu, select the Pr and set 5, and confirm. At this time, the system will restart, the digital tube will display UP, and the upgrade will begin. After the upgrade is completed, it will restart automatically.</li> </ol>
Smart module (optional)	<ol style="list-style-type: none"> <li>1. Program the 2.4G transmitter: Short press the DEC/Smart button, the buzzer will sound once, smart indicator LED will light on, enter the programming mode. Transmit the 2.4G signal, if the indicator LED flash twice and keep lighting on, which means the programming is successful. Otherwise, after 8s will exit the programming mode automatically.</li> <li>2. 2.4G control mode: while the mode received the 2.4G signal, it will open the gate once.</li> <li>3. Add the Bluetooth device: Open the XHouse IOT app, enter the add device mode, and choose the Bluetooth device. Choose the correct Bluetooth device, press the add button. (The Bluetooth device mode number is XHOUSE_092BLE_XXXXXX, XXXXXX is its serial number).</li> <li>4. Bluetooth device control mode: On the app, there has three buttons, including open, close and stop.</li> <li>5. Initialize the Bluetooth device: Hold press the 2.4G button about 5s, while you hear the buzzer sound two beep, release the button, the operation is complete.</li> <li>6. Factory reset the Bluetooth device: Hold press the 2.4G button about 10s, while you hear the buzzer sound with a long beep, release the button. After that, the module will erase all the 2.4G transmitter and initialize the Bluetooth device.</li> </ol>

## 9. Control board digital display menu setting

- ◆ Press and hold the [FUN] button for 3 seconds, and the digital display will indicate “A0”, then release the button, now the menu can be set to [INC/START] and [DEC/SMART] for increasing and decreasing numbers or values.
- ◆ After adjusting the value, press the [FUN] button to store the data, and the buzzer will beep one time to show the store successfully.
- ◆ After the menu setting is finished, press the [LEARN] button to exit the menu setting and close the display.

Item	Function description	Value	Factory default	Explanation
A0	Opening overcurrent setting in high speed	0~20 level	10	Opening overcurrent setting in high speed, the bigger the value is, the harder the motor to stop. Setting value from 0-20.
A1	Closing overcurrent setting in high speed	0~20 level	10	Closing overcurrent setting in high speed, the bigger the value is, the harder the motor to stop. Setting value from 0-20.
A2	Opening overcurrent setting in slow speed	0~20 level	6	Opening overcurrent setting in high speed, the bigger the value is, the harder the motor to stop. Setting value from 0-20.
A3	Closing overcurrent setting in slow speed	0~20 level	6	Closing overcurrent setting in high speed, the bigger the value is, the harder the motor to stop. Setting value from 0-20.
A8	Overcurrent sensitivity	0-3 level	0	The bigger the value is, the longer the overcurrent sensing time is. Setting value from 0-3
A9	Overcurrent reaction for closing	0-3	0	Setting overcurrent reaction of gate: 0: Reverse back to the end. 1: Reverse back 1 second and stop. 2: Reverse back 3 seconds and stop. 3: Stop
B0	Setting slow speed running time for opening	0-5 level	2	Used for setting the slow speed running time of the gate opening, gate will run in slow speed within this setting, then change to high speed with its rest travel. Setting from 0-5 seconds.
B1	Setting slow speed running time for closing	0-5 level	2	Used for setting the slow speed running time of the gate closing, gate will run in slow speed within this setting, then change to high speed with its rest travel. Setting from 0-5 level.



Item	Function description	Value	Factory default	Explanation
C0	Auto-closing timer for fully opening	0-99 seconds	0	Setting from 0-99 seconds, 0 means No auto-closing for fully opening.
D0	Setting high speed for opening	0-5 level	2	Setting speed of high speed for opening, setting from 0-5
D1	Setting high speed for closing	0-5 level	2	Setting speed of high speed for closing, setting from 0-5
D2	Setting slow speed for opening	0-5 level	2	Setting speed of slow speed for opening, setting from 0-5
D3	Setting slow speed for closing	0-5 level	2	Setting speed of slow speed for closing, setting from 0-5
E0	Pedestrian mode	0-15 seconds	6	0 means No pedestrian mode.
E1	Auto closing timer for pedestrian mode	0-99 seconds	0	0 means No auto-closing for pedestrian mode
F0	Limit switch mode	0-1	1	0: NC mode. 1: NO mode.
F1	Switch the limit direction	0-1	0	0: Default direction. 1: Switch direction.
F2	Safety beam mode	0-1	1	0: NC mode. 1: NO mode.
F3	Flash Lamp Mode	0-1	0	0: Flashing light and motor will operate and stop at the same time. 1: Flashing light will turn off 30 seconds after the motor stop.
G0	Setting of start terminal	0-4	0	0: Fully Open-Stop-Close..... 1: Pedestrian Open-Stop- Close. 2: Open only. 3: Close only. 4: Stop only.
G2	Setting of open terminal	0-4	2	0: Fully Open-Stop-Close..... 1: Pedestrian Open-Stop- Close. 2: Open only. 3: Close only. 4: Stop only.
G5	Setting of close terminal	0-4	3	0: Fully Open-Stop-Close..... 1: Pedestrian Open-Stop- Close. 2: Open only. 3: Close only. 4: Stop only
J1	Stop reaction distance in high speed	0-5	0	Setting from 0-5. The bigger the value is, the more abruptly the gate will stop.
J2	Switch the motor operation direction	0-1	0	0: Default direction. 1: Switch direction

Item	Function description	Value	Factory default	Explanation
L1	Button A function (Remote control)	0-6	1	0: No function. 1: Open-Stop-Close. 2: Pedestrian mode. 3: Open only. 4: Close only. 5: Stop only. 6: Turn auto close off via remote.
L2	Button B function (Remote control)	0-6	0	0: No function. 1: Open-Stop-Close. 2: Pedestrian mode. 3: Open only. 4: Close only. 5: Stop only. 6: Turn auto close off via remote.
L3	Button C function (Remote control)	0-6	0	0: No function. 1: Open-Stop-Close. 2: Pedestrian mode. 3: Open only. 4: Close only. 5: Stop only. 6: Turn auto close off via remote.
L4	Button D function (Remote control)	0-6	6	0: No function. 1: Open-Stop-Close. 2: Pedestrian mode. 3: Open only. 4: Close only. 5: Stop only. 6: Turn auto close off via remote
Pr	Trigger auto travelling learning	0-10	0	Setting from 0-10. Set 5 will trigger the slow speed auto travel learning. Set 10 will trigger the high speed auto travel learning. 0 means No auto travel learning.
Pr	Trigger auto travelling learning	0-10	0	Setting from 0-10. Set 5 will trigger to upgrade the system. 0 means No upgrade the system.
Po	Factory reset	0-10	0	Setting from 0-10. Set 5 will trigger to reset operation. 0 means No reset.

### Control board digital display information show

1. When the gate is start to open, the digital display will show "OP"
2. When the gate is start to close, the digital display will show "CL"
3. After the gate stop moving, the digital display will show "--"
4. When the gate is fully opened, the digital display will show "LO"

5. When the gate is fully closed, the digital display will show "LC"
6. When the motor reaches max working time, the digital display will show "EC"
7. When the motor trigger the overcurrent in high speed, the digital display will show "OH" .  
When the motor trigger the overcurrent in slow speed, the digital display will show "OL" .
8. After the photocell is activated, the digital display will show "PH"
9. After the PED mode is activated, the digital display will show "Pd"
10. After the motor protection is activated, the digital display will show "HE"
11. When the limit switch broken or has a bug, the digital display will show "Lr"
12. Cancel the auto-closing, the digital display will show "CC"

## 10. Smart module instruction

Search “XHouse IOT” and download it from Google play or App Store



**FOR Android & IOS**



- Or scan this QR code for download APP “XHouse IOT” and install it. Register the account for “XHouse IOT” and log in.

### ● Add the device

Step 1. Power on the device, open the APP. Press the “⊕” on the top right corner to add the device, then select the “ Sliding Gate ” which has a orange cycle on the top right corner. (Fig 1 and 2)

★ If there has a gray cycle on the top right corner, that means the device already be added. The user need to press and hold the “Dec/Smart” button for about 5s on the control board, then repeat the step 1.

★ If there has a message “Please enter distribution network mode and add devices”, the user need to press and hold the “Dec/Smart” button for about 5s on the control board, then repeat the step 1.

Step 2. Select the Wi-Fi, click the “Connect” and enter the password.(Fig 3) (If there hasn't Wi-Fi can be connected, the user also can select the “ Bluetooth Add ” and use the Bluetooth function to control the gate nearby. Please follow the step 4).

Step 3. Add the device successfully. The user can modify the name of the device and button from the “⚙️” on the top right corner. (Fig 5)

Step 4: Bluetooth Add: When using Bluetooth mode control, the mobile app must be close to the device within Bluetooth range to connect and control, and only one user's phone can be connected at a time. (Fig. 3 and 4).

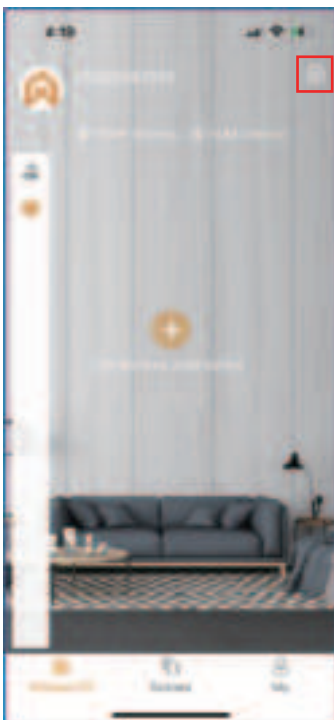

Fig 1



Fig 2



Fig 3

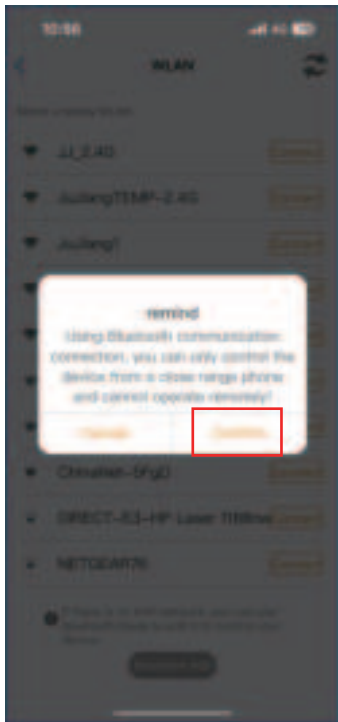

Fig 4

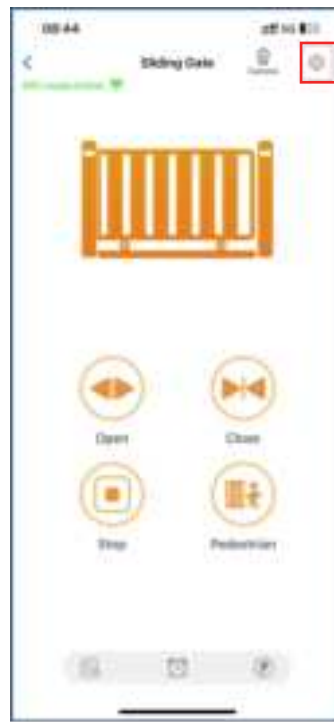

Fig 5

● **Device supports WIFI and bluetooth working mode**

- ★ When the device is connected to WiFi network successfully, it supports remote control and settings the device through the mobile phone APP. (Fig 5)
- ★ When the device is offline or the mobile phone has no network, if the user is nearly the device within 10 meters, and open the APP, it will automatically switch to the Bluetooth mode to control the device. (Fig 6)
- ★ The device will establish a Bluetooth connection with the mobile phone to achieve close-range Bluetooth control (only one user's mobile phone can establish a Bluetooth connection at the same time).



Fig 5



Fig 6

● **Switch WiFi network or bluetooth mode**

If the user need to switch to use a new WiFi network or want to switch control mode from the Bluetooth mode to WiFi mode, please follow the steps.

Step 1. Select the device, press the “⚙️” on the top right corner. Click the “ Set/Modify WiFi ”. (Fig 7)

Step 2. Select the new WiFi and connect it. And click the “Refresh”. (Fig 8)



Fig 7



Fig 8

● **Share the device**

Step 1. Open the APP, select the device. Press the “⚙️” on the top right corner, then select to “Sharing device”, will create a QR code. (Fig 9)

Step 2. The new user download the APP and open it, Press the “Scan” on the top right corner to scan the QR code. (Fig 10)

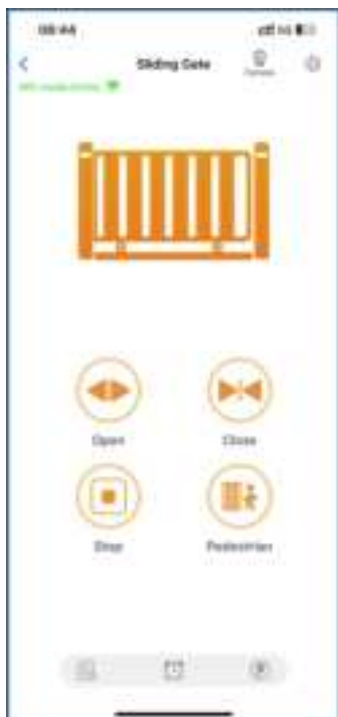

Fig 9



Fig 10

- **Device settings**

The user can set the parameters from the APP for the control board.

Step 1. Select the device, press the “⚙️” on the top right corner. Click the “Setting”. (Fig 11)

Step 2. Set the parameters on the APP. (Fig 12)

**Note: While the user want to set the parameters, the device must connect with the Wi-Fi. If not, the user need to use the Bluetooth function and put the phone app as close as the device to set the parameters. After done, please click the “Sync” button.**



Fig 11



Fig 12

- **Remote assistance**

When your equipment fails, the parameter settings need to be readjusted. At this time, you can directly initiate the “Remote Assistance” button and share the QR code or verification code with your installation service provider for the remote service.



Fig 13



Fig 14

● **Add USB card / RF remote control at site**

When the user need to add a RF remote control or a USB card to open the gate, you can use the “Add Card / Remote Control control at site” function to do it, and scan the QR code from the remote control or enter the ID number for the USB card. Don’t need to open the control box to program them.

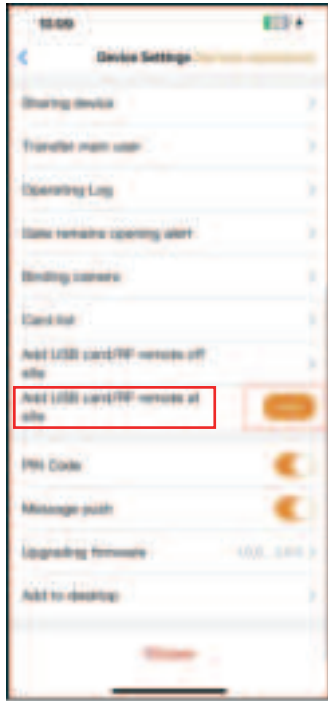

Fig 15

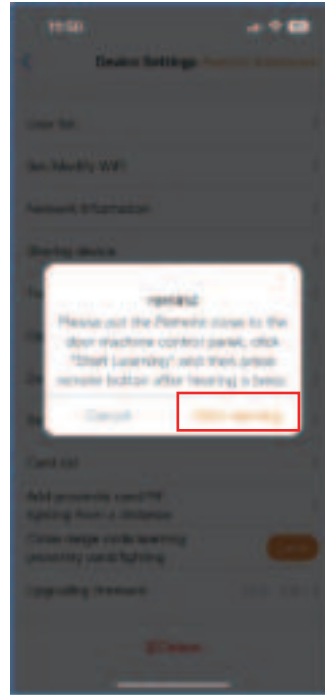

Fig 16

● **Add USB card/RF remote control off site**

When the user needs to add an RF remote control or USB proximity card to open the gate, you can directly use the "Add USB card/RF remote off site" function, click the "Learn" button, and click "Start Learning". Don't need to open the control box, and the control board will enter the code learning state, and then press the remote control button or power on the USB card to transmit a signal.

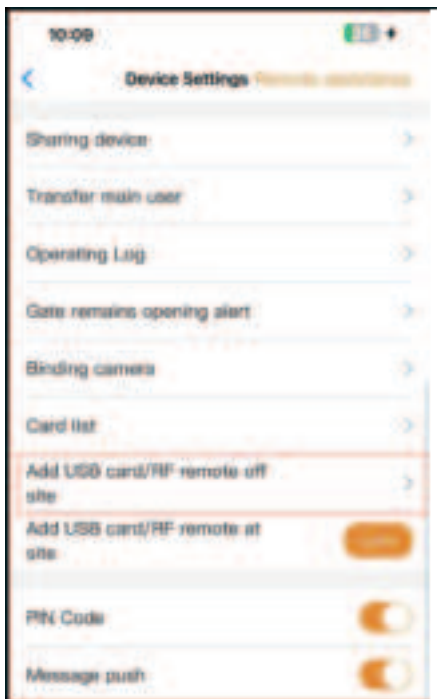

Fig 17



Fig 18



- **Management of the USB card and RF remote control**

The card list can management your USB card and RF remote control. The user can sync all the cards and remotes to the card list for management, and delete it when they are no longer needed or lost.



Fig 19

- **Binding with camera**

Step 1. Open the APP, select the device. Press the “⚙️” on the top right corner, then select to “Binding camera”.

Step 2. Select the “IP camera”, and press the “Comfirm” to confirm it.

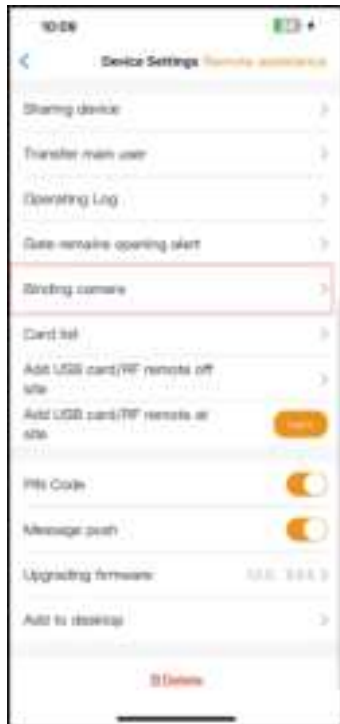

Fig 20

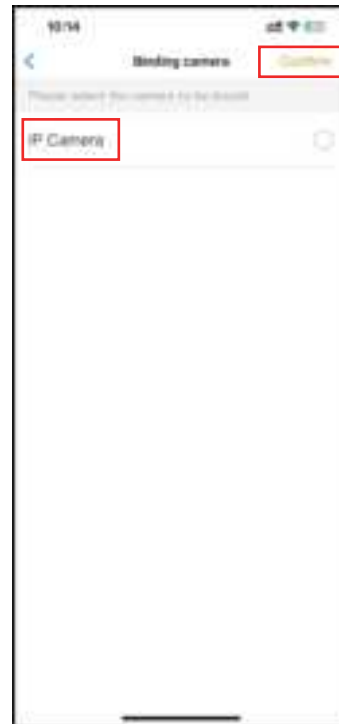

Fig 21