

# Honeywell Home



## Y87RFC

### Connected Single Zone Thermostat

EN Quick Start Guide





## Installation in 3 steps

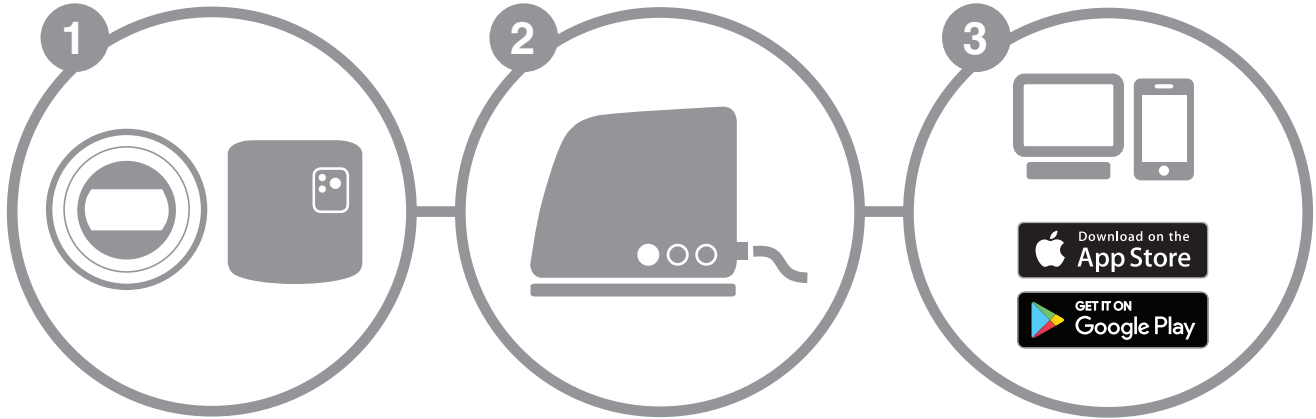

Install the Thermostat  
and Boiler Relay

Install the  
Internet Gateway

Get Connected

## Preparation

### Before installation

- Check that the thermostat is compatible with your boiler. Refer to the boiler manufacturer's instructions.
- The wireless thermostat can be located almost anywhere you wish; see diagrams for guidance on the ideal location. As it requires no wires it makes the installation very simple.
- **Before installing the Boiler Relay, ensure the mains power to the boiler is switched off.**



### During installation

You will need the following:

- Cross-head screwdriver
- Small flat blade screwdriver
- Pliers
- Wire-strippers

### After installation

- Dispose of any old electronic equipment at an authorised recycling centre.

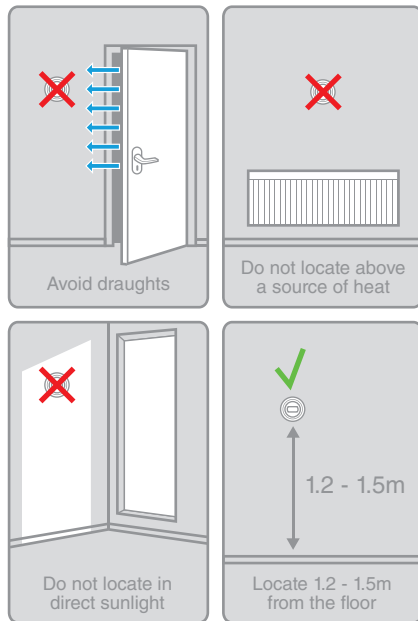

## Step 1 : Install the Thermostat and Boiler Relay

1. If necessary, disconnect and remove the old equipment.

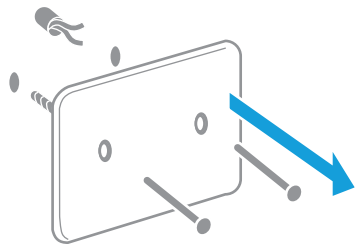

### Attention!

This thermostat does not require any wiring. Isolate any conductors and reposition them inside the wall.

2. Separate the thermostat from the mounting plate.

Remove the setpoint dial

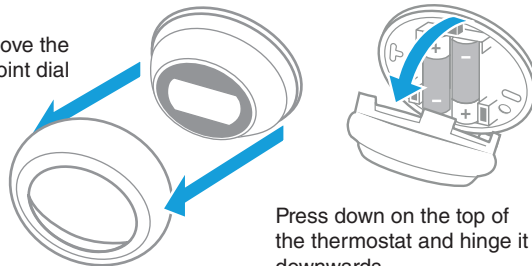

Press down on the top of the thermostat and hinge it downwards

3. Attach the mounting plate to the wall.

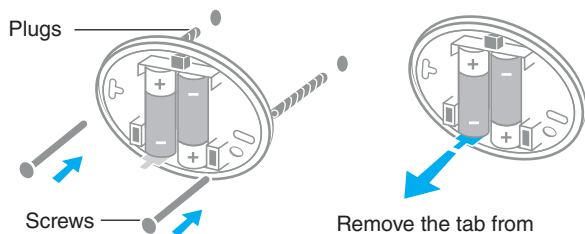

Remove the tab from between the batteries

4. Reattach the thermostat to the mounting plate

Hook the thermostat hinges into the base of the mounting plate

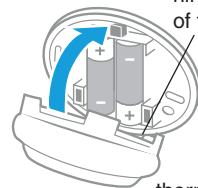

Hinge the thermostat upwards and click into place

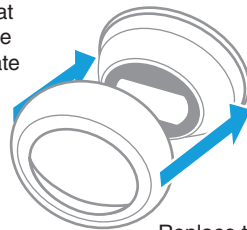

Replace the setpoint dial

## Step 1 b : Install the Thermostat and Boiler Relay

### 5. Remove the wiring plate from the Boiler Relay.

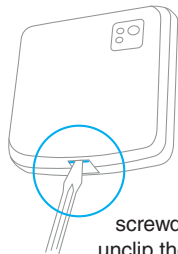

Use a screwdriver to unclip the cover from base.



Hinge the cover upwards to remove.

### 6. Mount the wiring plate to the wall.

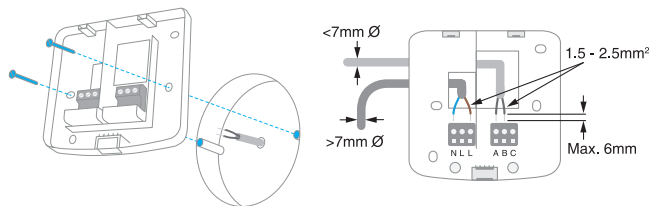

Mount on a plastic wallbox or directly on the wall next to the boiler. For best RF performance keep a distance of at least 30cm from the boiler, other metal objects or mains cables.

### 7. Wiring the Boiler Relay

Refer to the boiler installation guide for instructions on wiring the Boiler Relay to the correct terminals in the boiler.

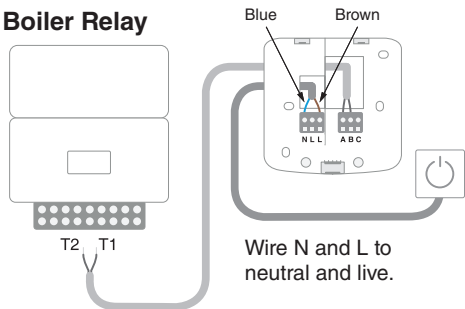

Wire N and L to neutral and live.

### 8. Attach the Boiler Relay to the wiring plate.

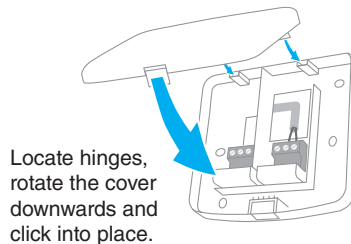

Locate hinges, rotate the cover downwards and click into place.

Reconnect the mains power to the installation.



## Step 2 : Install the Internet Gateway RFG100

### 1. Connect the Gateway to a mains power source.

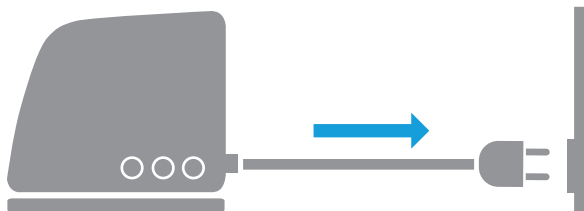

During power up the 3 LEDs will light up red.

The power (⏻) and RF communication (📶) LEDs should then change to green - indicating that the Gateway is powered and successfully connected to the Thermostat.

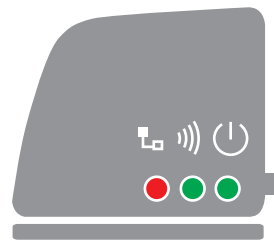

---

### 2. Connect the Gateway to an internet router with the provided Ethernet cable.

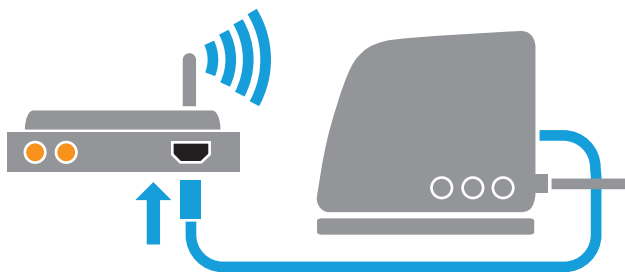

The connectivity (📶) LED should begin to flash green - indicating that the Gateway has successfully connected to the internet (but not yet registered)

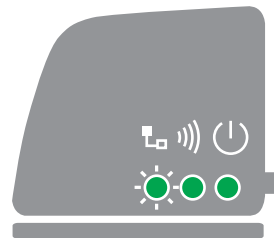

## Step 3 : Get Connected

### 1. Create an account online.

Visit the website below and follow the steps to create an account.



[getconnected.honeywellhome.com](https://getconnected.honeywellhome.com)

### 2. Name your location.

After creating an account and receiving the activation confirmation e-mail, choose a suitable name for the location of the thermostat (e.g. **My Home**).



The screenshot shows a web form titled "Location Registration" with a red header. Below the header, it says "Please complete all sections of this form." and "Indicates required field". The form is divided into sections. The first section is "General Information". It contains a "Location Name\*" field with a text input box containing "e.g. My Home". Below that is a "Location Type" section with two radio button options: "Residential" (selected) and "Commercial".



## Step 3 : Get Connected

### 3. Register the Internet Gateway.



Enter the MAC and CRC codes of your Internet Gateway



The MAC and CRC codes are on the information label on the bottom of the Gateway.

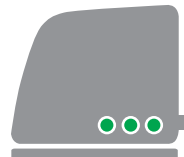

The green LED will stop flashing when the Internet Gateway has been successfully registered.

### 4. Download the Smartphone App



Download the “**Total Connect Comfort International**” App for your Smartphone or Tablet.

### 5. Use the app



Log in to the App and start controlling your heating remotely, or setting up a heating schedule for each day of the week.

## Error Messages



Loss of RF communication with the Gateway

Cycle the power to the Gateway and verify that it is located within the RF communication limits of the thermostat.



Loss of RF communication with the Thermostat

Check the RF thermostat is powered and is within RF range.



No internet connection

Check the router has access to the internet.



Connecting to the router

If the LED stays orange, check the cables and power supply to the router.



Gateway not yet registered

Create an account and register the Internet Gateway on: [getconnected.honeywellhome.com](https://getconnected.honeywellhome.com)

Note : RF communication can be affected by obstacles, metal objects or excessive distance between the RF devices. It may be necessary to reposition devices for better performance if the RF communication seems unreliable.



**For support:**

**Resideo**

200 Berkshire Place

Winnersh Triangle, Berkshire

RG41 5R

Phone: 0300 130 1299



**resideo**

Pittway Sarl, Z.A. La Pièce 4,  
1180 Rolle, Switzerland

**www.resideo.com**

Country of origin : UK

© 2020 Resideo Technologies, Inc. All rights reserved.

The Honeywell Home trademark is used under license from Honeywell International Inc.

This product is manufactured by Resideo Technologies, Inc. and its affiliates.

32300956-012 B