

WORX NITRO

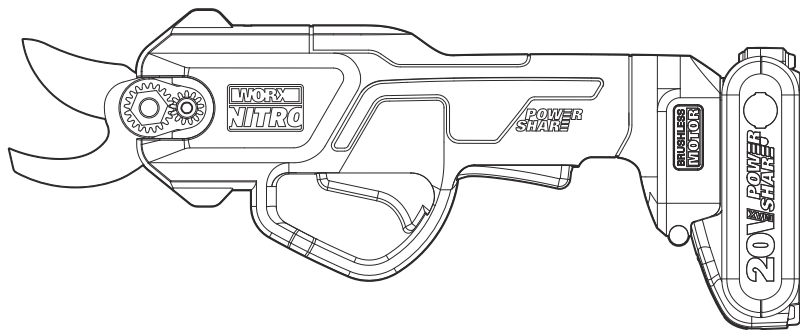

SAFETY AND OPERATING MANUAL

Cordless Pruning Shears

WG330E WG330E.X

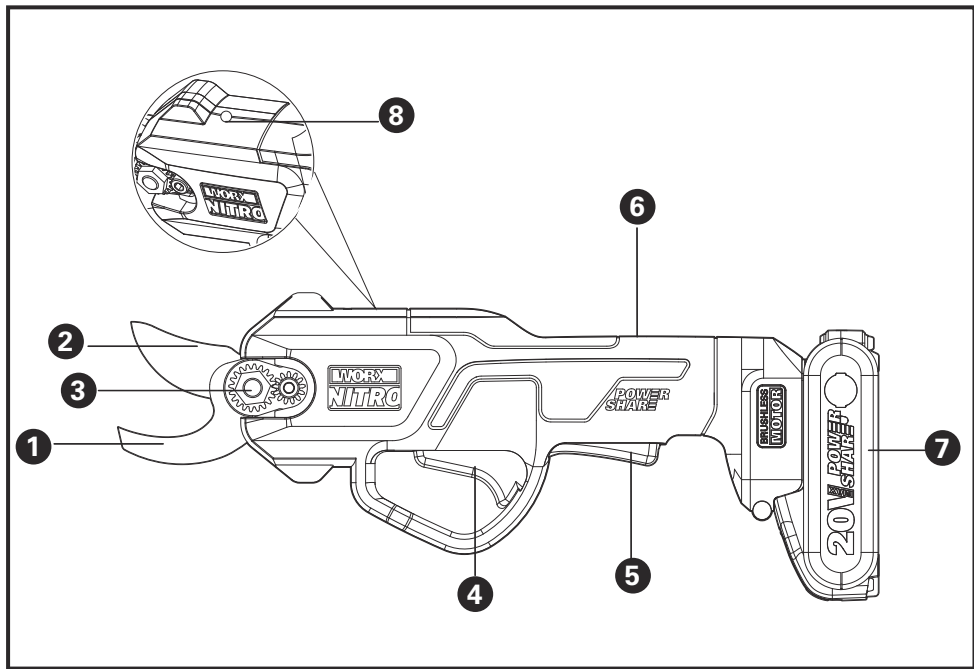

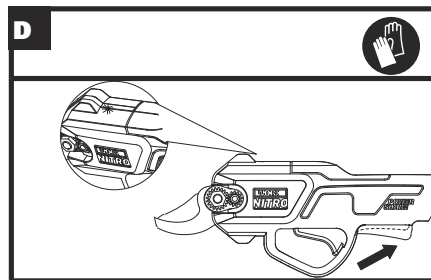
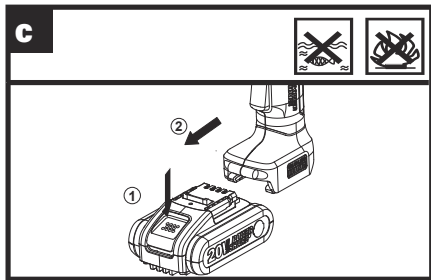
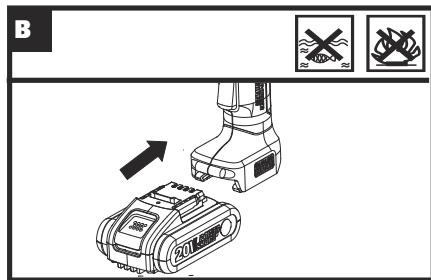
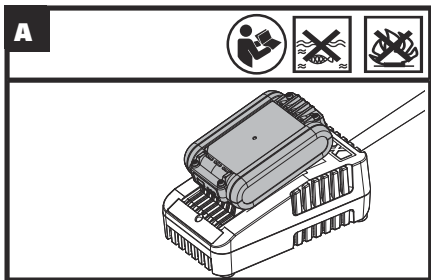

E

Beep!

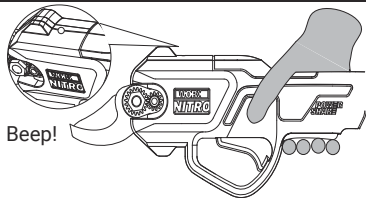
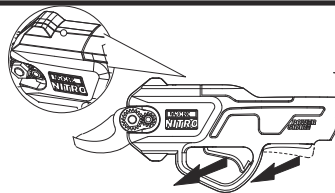
**F****G**

A

Beep!

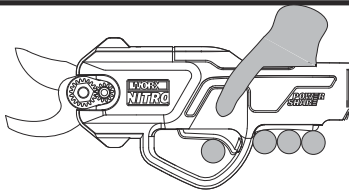
**H**

B

Beep!

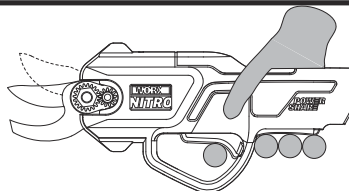

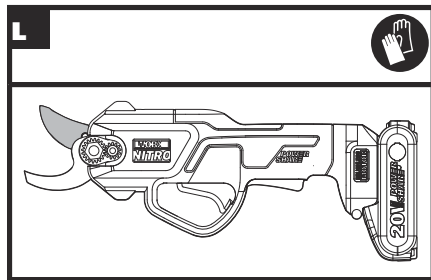
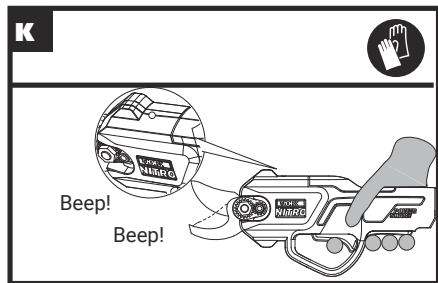
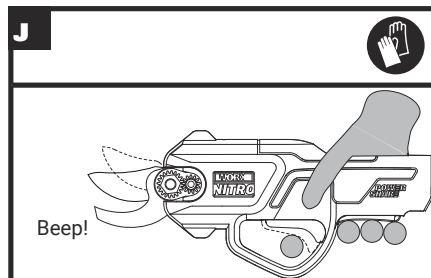
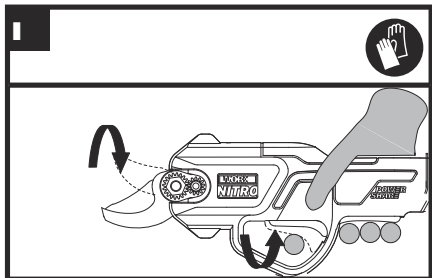

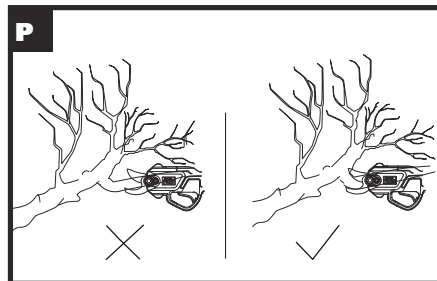
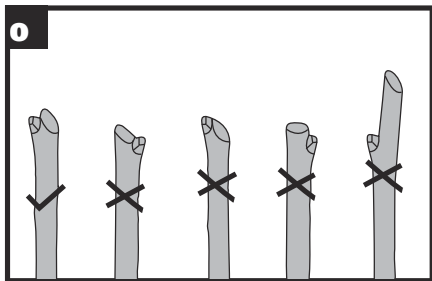
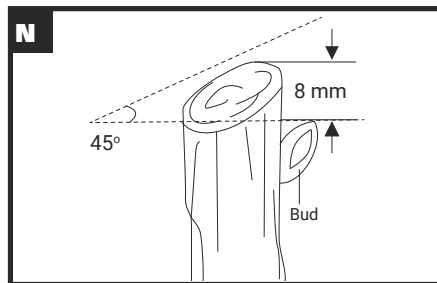
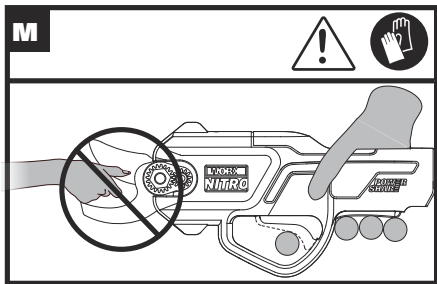

TABLE OF CONTENTS

1. SAFETY INSTRUCTIONS
2. COMPONENT LIST
3. TECHNICAL DATA
4. INTENDED USE
5. OPERATION INSTRUCTIONS
6. MAINTENANCE
7. STORAGE
8. ENVIRONMENTAL PROTECTION
9. DECLARATION OF CONFORMITY

1. SAFETY INSTRUCTIONS

ORIGINAL INSTRUCTIONS

8

GENERAL POWER TOOL SAFETY WARNINGS

 **WARNING:** Read all safety warnings, instructions, illustrations and specifications provided with this power tool. Failure to follow all instructions may result in electric shock, fire and/or serious personal injury.

Save all warnings and instructions for future reference. The term "power tool" in the warnings refers to your mains-operated (corded) power tool or battery-operated (cordless) power tool.

- 1) **Work area safety**
 - a) **Keep work area clean and well lit.** Cluttered or dark areas invite accidents.
 - b) **Do not operate power tools in explosive atmospheres, such as in the presence of**

flammable liquids, gases or dust. Power tools create sparks which may ignite the dust or fumes.

- c) **Keep children and bystanders away while operating a power tool.** Distractions can cause you to lose control.
- 2) **Electrical safety**
 - a) **Power tool plugs must match the outlet. Never modify the plug in any way. Do not use any adapter plugs with earthed (grounded) power tools.** Unmodified plugs and matching outlets will reduce risk of electric shock.
 - b) **Avoid body contact with earthed or grounded surfaces, such as pipes, radiators, ranges and refrigerators.** There is an increased risk of electric shock if your body is earthed or grounded.
 - c) **Do not expose power tools to rain or wet conditions.** Water entering a power tool will increase the risk of electric shock.
 - d) **Do not abuse the cord. Never use the cord for carrying, pulling or unplugging the power tool. Keep cord away from heat, oil, sharp edges or moving parts.** Damaged or entangled cords increase the risk of electric shock.
 - e) **When operating a power tool outdoors, use an extension cord suitable for outdoor use.** Use of a cord suitable for outdoor use reduces the risk of electric shock.
 - f) **If operating a power tool in a damp location is unavoidable, use a residual current device (RCD) protected supply.** Use of an RCD reduces the risk of electric shock.

3) Personal safety

- a) **Stay alert, watch what you are doing and use common sense when operating a power tool. Do not use a power tool while you are tired or under the influence of drugs, alcohol or medication.** A moment of inattention while operating power tools may result in serious personal injury.
- b) **Use personal protective equipment. Always wear eye protection.** Protective equipment such as dust mask, non-skid safety shoes, hard hat, or hearing protection used for appropriate conditions will reduce personal injuries.
- c) **Prevent unintentional starting. Ensure the switch is in the off-position before connecting to power source and/or battery pack, picking up or carrying the tool.** Carrying power tools with your finger on the switch or energising power tools that have the switch on invites accidents.
- d) **Remove any adjusting key or wrench before turning the power tool on.** A wrench or a key left attached to a rotating part of the power tool may result in personal injury.
- e) **Do not overreach. Keep proper footing and balance at all times.** This enables better control of the power tool in unexpected situations.
- f) **Dress properly. Do not wear loose clothing or jewellery. Keep your hair and clothing away from moving parts.** Loose clothes, jewellery or long hair can be caught in moving parts.
- g) **If devices are provided for the connection of dust extraction and collection facilities, ensure these are connected and properly used.** Use of dust

collection can reduce dust-related hazards.

- h) **Do not let familiarity gained from frequent use of tools allow you to become complacent and ignore tool safety principles.** A careless action can cause severe injury within a fraction of a second.
- ### 4) Power tool use and care
- a) **Do not force the power tool. Use the correct power tool for your application.** The correct power tool will do the job better and safer at the rate for which it was designed.
 - b) **Do not use the power tool if the switch does not turn it on and off.** Any power tool that cannot be controlled with the switch is dangerous and must be repaired.
 - c) **Disconnect the plug from the power source and/or remove the battery pack, if detachable, from the power tool before making any adjustments, changing accessories, or storing power tools.** Such preventive safety measures reduce the risk of starting the power tool accidentally.
 - d) **Store idle power tools out of the reach of children and do not allow persons unfamiliar with the power tool or these instructions to operate the power tool.** Power tools are dangerous in the hands of untrained users.
 - e) **Maintain power tools and accessories. Check for misalignment or binding of moving parts, breakage of parts and any other condition that may affect the power tool's operation. If damaged, have the power tool repaired before use.** Many accidents are caused by poorly maintained power

tools.

- f) **Keep cutting tools sharp and clean.** Properly maintained cutting tools with sharp cutting edges are less likely to bind and are easier to control.
 - g) **Use the power tool, accessories and tool bits etc. in accordance with these instructions, taking into account the working conditions and the work to be performed.** Use of the power tool for operations different from those intended could result in a hazardous situation.
 - h) **Keep handles and grasping surfaces dry, clean and free from oil and grease.** Slippery handles and grasping surfaces do not allow for safe handling and control of the tool in unexpected situations.
-
- 10
- 5) **Battery tool use and care**
 - a) **Recharge only with the charger specified by the manufacturer.** A charger that is suitable for one type of battery pack may create a risk of fire when used with another battery pack.
 - b) **Use power tools only with specifically designated battery packs.** Use of any other battery packs may create a risk of injury and fire.
 - c) **When battery pack is not in use, keep it away from other metal objects, like paper clips, coins, keys, nails, screws or other small metal objects, that can make a connection from one terminal to another.** Shorting the battery terminals together may cause burns or a fire.
 - d) **Under abusive conditions, liquid may be ejected from the battery; avoid contact. If contact accidentally occurs, flush with water. If liquid**

contacts eyes, additionally seek medical help.

Liquid ejected from the battery may cause irritation or burns.

- e) **Do not use a battery pack or tool that is damaged or modified.** Damaged or modified batteries may exhibit unpredictable behaviour resulting in fire, explosion or risk of injury.
 - f) **Do not expose a battery pack or tool to fire or excessive temperature.** Exposure to fire or temperature above 130 °C may cause explosion.
 - g) **Follow all charging instructions and do not charge the battery pack or tool outside the temperature range specified in the instructions.** Charging improperly or at temperatures outside the specified range may damage the battery and increase the risk of fire.
- 6) **Service**
 - a) **Have your power tool serviced by a qualified repair person using only identical replacement parts.** This will ensure that the safety of the power tool is maintained.
 - b) **Never service damaged battery packs.** Service of battery packs should only be performed by the manufacturer or authorized service providers.

SAFETY WARNINGS FOR BATTERY PACK

- a) **Do not dismantle, open or shred cells or battery pack.**
- b) **Do not short-circuit a battery pack. Do not store battery packs haphazardly in a box or drawer**





where they may short-circuit each other or be short-circuited by conductive materials. When battery pack is not in use, keep it away from other metal objects, like paper clips, coins, keys, nails, screws or other small metal objects, that can make a connection from one terminal to another. Shorting the battery terminals together may cause burns or a fire.

- c) **Do not expose battery pack to heat or fire. Avoid storage in direct sunlight.**
- d) **Do not subject battery pack to mechanical shock.**
- e) **In the event of battery leaking, do not allow the liquid to come into contact with the skin or eyes. If contact has been made, wash the affected area with copious amounts of water and seek medical advice.**
- f) **Keep battery pack clean and dry.**
- g) **Wipe the battery pack terminals with a clean dry cloth if they become dirty.**
- h) **Battery pack needs to be charged before use. Always refer to this instruction and use the correct charging procedure.**
- i) **Do not maintain battery pack on charge when not in use.**
- j) **After extended periods of storage, it may be necessary to charge and discharge the battery pack several times to obtain maximum performance.**
- k) **Recharge only with the charger specified by Worx. Do not use any charger other than that specifically provided for use with the equipment.**
- l) **Do not use any battery pack which is not designed**

for use with the equipment.

- m) **Keep battery pack out of the reach of children.**
- n) **Retain the original product literature for future reference.**
- o) **Remove the battery from the equipment when not in use.**
- p) **Dispose of properly.**
- q) **Do not use battery packs of different manufacture, size or type.**
- r) **Keep the battery away from microwaves and high pressure.**

SYMBOLS

	To reduce the risk of injury, user must read instruction manual
	Wear ear protection
	Wear eye protection
	Wear dust mask



Batteries may enter water cycle if disposed improperly, which can be hazardous for ecosystem. Do not dispose of waste batteries as unsorted municipal waste.



Do not burn



Waste electrical products must not be disposed of with household waste. Please recycle where facilities exist. Check with your local authorities or retailer for recycling advice.



Li-Ion battery. This product has been marked with a symbol relating to 'separate collection' for all battery packs and battery pack. It will then be recycled or dismantled in order to reduce the impact on the environment. Battery packs can be hazardous for the environment and for human health since they contain hazardous substances.



Wear protective gloves.



Warning

2. COMPONENT LIST

1. **FIXED BLADE**
2. **CUTTING BLADE**
3. **BLADE LOCK BOLT**
4. **ON/OFF TRIGGER**
5. **SAFETY LOCK TRIGGER**
6. **HANDLE**
7. **20V BATTERY PACK ***
8. **LED LIGHT INDICATOR**

* **Not all the accessories illustrated or described are included in standard delivery.**

3. TECHNICAL DATA

Type WG330E WG330E.X (330- designation of machinery, representative of Cordless Pruning Shears)

	WG330E WG330E.X**
Voltage	20V  Max.***
Blade opening size	15mm, 25mm
Max cutting Capacity	25mm
Machine Weight (bare tool)	0.7kg

** X=1-999, A-Z, M1-M9 there are only used for different customers, there are no safe relevant changes between these models.

*** Voltage measured without workload. Initial battery voltage reaches maximum of 20 volts. Nominal voltage is 18 volts.

SUGGESTED BATTERIES AND CHARGERS

Category	Type	Capacity
20V Battery	WA3551	2.0 Ah
20V Charger	WA3880	2.0 A

We recommend that you purchase your accessories from the same store that sold you the tool. Choose the type according to the work you intend to undertake.

Refer to the accessory packaging for further details. Store personnel can assist you and offer advice.

NOISE DATA

A weighted sound pressure	$L_{pA} = 59.95 \text{ dB(A)}$
K_{pA}	3.0 dB (A)
A weighted sound power	$L_{wA} = 72 \text{ dB(A)}$
K_{wA}	3.0 dB (A)
Wear ear protection	

VIBRATION INFORMATION

Vibration total values (triax vector sum) determined according to EN 62841:

Typical weighted vibration	$a_h < 2.5 \text{ m/s}^2$
Uncertainty	$K = 1.5 \text{ m/s}^2$

The declared vibration total value and the declared noise emission value have been measured in accordance with a standard test method and may be used for comparing one tool with another.

The declared vibration total value and the declared noise emission value may also be used in a preliminary assessment of exposure.

WARNING: The vibration and noise emissions during actual use of the power tool can differ from the declared value depending on the ways in which the tool is used especially what kind of workpiece is processed dependant on the following examples and other variations on how the tool is used:

How the tool is used and the materials being cut or drilled.

The tool being in good condition and well maintained.

The use of the correct accessory for the tool and ensuring it is sharp and in good condition.

The tightness of the grip on the handles and if any anti vibration and noise accessories are used.

And the tool is being used as intended by its design and these instructions

This tool may cause hand-arm vibration syndrome if its use is not adequately managed.

WARNING: To be accurate, an estimation of exposure level in the actual conditions of use should also take account of all parts of the operating cycle such as the times when the tool is switched off and when it is running idle but not actually doing the job. This may significantly reduce the exposure level over the total working period.

Helping to minimise your vibration and noise exposure risk. Always use sharp chisels, drills and blades.

Maintain this tool in accordance with these instructions and keep well lubricated (where appropriate).

If the tool is to be used regularly then invest in anti vibration and noise accessories.

Plan your work schedule to spread any high vibration tool

use across a number of days.

4. INTENDED USE

This product is intended to remove smaller, weak branches to raise the canopy of the tree, while allowing the larger limbs to grow and get stronger, which makes the tree mass look taller and lets more sun onto the ground to promote grass growth, inhibit the growth of smaller plants/trees/bushes, and allow for clearance of walkways. In addition, the product could be used to cut fresh and dried tree branches for delimiting and downcutting.

5. OPERATING INSTRUCTIONS



NOTE: Read instruction handbook before operation this machine.

ASSEMBLY AND OPERATION

ACTION	FIGURE
BEFORE OPERATION	
Charging the battery pack	See Fig. A
Installing/Removing the battery pack  WARNING: Please make sure to close the blades firstly, then pull the battery pack out.	See Fig. B.C
ACTIVATING THE PRODUCT	

Depress Safety Lock Trigger, 0.5 seconds later, the LED Light Indicator turns on and the product is ready to work after a beep.  WARNING: Wear protective gloves and eye protection while working with the pruner	See Fig. D
If no action in 10 seconds, then the LED Light Indicator will go out and the product will turn off after hearing a beep.	See Fig. E
If you release the Safety Lock Trigger directly, then LED Light Indicator and the product will turn off.	See Fig. F
UNLOCKING THE PRODUCT	
Once activated, hold down Safety Trigger, while simultaneously depressing the ON/OFF Trigger to engage the blades. A. If the blades are in the MAX cut opening, the product will beep once and blades keep the MAX cut opening; B. If the blades are not in the MAX cut opening, the product will beep once and blades will reach the MAX cut opening.	See Fig. G.H
PROGRESSIVE CUTTING	

The blades will naturally return to the open position when the ON/OFF Trigger is released, while the blades will get closed once push the ON/OFF Trigger. The degree of blade's closure will be controlled by the degree of ON/OFF Trigger's closure. NOTE: When the scissors can't cut cause the material is too hard or too stiff, the product will beep once, then the scissors return to the open state and stop working.	See Fig. I
EXCHANGE THE CUTTING SIZE	

This product could be adjusted to different opening width.

While product is active, depress the Safety Trigger while simultaneously depressing the ON/OFF Trigger. 2 seconds later, please release the ON/OFF Trigger after hearing a beep. Then the blades could exchange cutting size between MAX cut opening and small cut opening in order.



WARNING! When the product is in the open position, even if release both triggers, the product will stay active for about one minute.

Need to re-run the product-

Within one minute, firstly push the Safety Lock trigger and later depress the ON/OFF Trigger, then the product will get re-activated to work. Even if you release the ON/OFF Trigger while depressing the Safety Lock trigger, the product will be able to cut once press the ON/OFF Trigger within 20 seconds. Or else, the LED Light Indicator will go out and the product will turn off if you do not press the ON/OFF Trigger within 20 seconds.

No need to re-run the product-

The product will be powered down if no action within 1 minute.

STORAGE MODE & SWITCH OFF

See Fig. J

While product is active, depress the Safety Trigger while simultaneously depressing the ON/OFF Trigger. The blades will close and beep once. Continue to hold until product beeps twice. LED Light Indicator will turn off, blades will stay closed, and product is now inactive. Remove battery for storage.



WARNING: Please remove battery for storage after the blades have been closed and the product has turned off.

See Fig. K

The cutting blade is coated with Titanium, which improves the lifespan of the durable and effective high carbon steel SK5 blade by 3 times or more. Its non-stick characteristics also makes cleaning and maintenance a breeze



WARNING: Do not touch the blades with your hands.

See Fig.L.M

PRUNING TIPS

The cordless pruner shears are ideal for cutting and trimming shrub and tree branches to promote healthy growth, and to control the shape.

1. Please make sure the cut is always above 8mm from the bud cause this will allow wound to heal properly and angle that the branch should be cut at 45°. (**See Fig N**)
2. When cutting, please do clean cuts that slope away from the bud, which will let rain run away easily and encourage new growth. (**See Fig O**)

3. When pruning the entire stem, please cut the stem from the point where it branched. (See Fig P)

6. MAINTENANCE

 **WARNING: When you need to start inspection, maintenance and cleaning work, please make sure the product has been switched off, it has cooled down and the battery pack has been removed.**

1. Never use solvents to clean the product and never immerse the product in any liquid. Only use a dry cloth to clean the product.
2. Never directly operate the product if some broken or worn parts are found. Please inspect the product before each usage.

BLADE MAINTENANCE

1. When need to sharpen the blades, please open the blades to the max cut opening, turn the product off and remove the battery. Then use a strip of grindstone to sharpen the blades in a careful way.
2. Always keep blades free of leaves or debris.

 **WARNING:** Wear protective gloves while clean and sharpen the blades.

7. STORAGE

 **WARNING: When not in use, please press the on/off switch for a long time to close the blades as operation instruction shown.**

1. Keep the product in a dry place and never let it immerse

into any liquid.

2. Keep the product from away from children.
3. Before use the product after long-time storage, please fully recharge the product.

8. ENVIRONMENTAL PROTECTION

 Waste electrical products must not be disposed of with household waste. Please recycle where facilities exist. Check with your local authorities or retailer for recycling advice.

FOR BATTERY TOOLS

The ambient temperature range for tool and battery use and storage is 0°C-45°C.

The recommended ambient temperature range for the charging system during charging is 0°C-40°C.

9. DECLARATION OF CONFORMITY

We,
Positec Germany GmbH
Postfach 32 02 16, 50796 Cologne, Germany

On behalf of Positec declare that the product
Description **Cordless Pruning Shears**
Type **WG330E WG330E.X (330- designation of machinery, representative of Cordless Pruning Shears)**
Function **Pruning**

Complies with the following Directives,
2006/42/EC , 2011/65/EU&(EU)2015/863, 2014/30/EU

Standards conform to,
EN 62841-1+EN ISO 12100, EN 55014-1, EN 55014-2

The person authorized to compile the technical file,
Name: Marcel Filz
Address Positec Germany GmbH
Postfach 32 02 16, 50796 Cologne, Germany



2022/4/7
Allen Ding
Deputy Chief Engineer, Testing & Certification

Positec Technology (China) Co., Ltd
18, Dongwang Road, Suzhou Industrial
Park, Jiangsu 215123, P. R. China

9. DECLARATION OF CONFORMITY

We,
Positec (UK & Ireland) Ltd.
PO Box 6242, Newbury, RG14 9LT, UK

On behalf of Positec declare that the product
Description **Cordless Pruning Shears**
Type **WG330E WG330E.X (330- designation of machinery, representative of Cordless Pruning Shears)**
Function **Pruning**

Complies with the following regulations,
Supply of Machinery (Safety) Regulations 2008
Electromagnetic Compatibility Regulations 2016
The Restriction of the Use of Certain Hazardous Substances in Electrical and Electronic Equipment Regulations

Standards conform to,
BS EN 62841-1+EN ISO 12100, BS EN 55014-1, BS EN 55014-2

The person authorized to compile the technical file,
Name: Jim Kirkwood
Address: Positec (UK & Ireland) Ltd.,
PO Box 6242, Newbury, RG14 9LT, UK



2022/4/7
Allen Ding
Deputy Chief Engineer, Testing & Certification
Positec Technology (China) Co., Ltd
18, Dongwang Road, Suzhou Industrial
Park, Jiangsu 215123, P. R. China





www.worx.com

Copyright © 2022, Positec. All Rights Reserved.
V0-UK-WG330E WG330E.X-M-20220407