

ROYALCRAFT

Transforming houses into homes (English & Español)

ZFK066

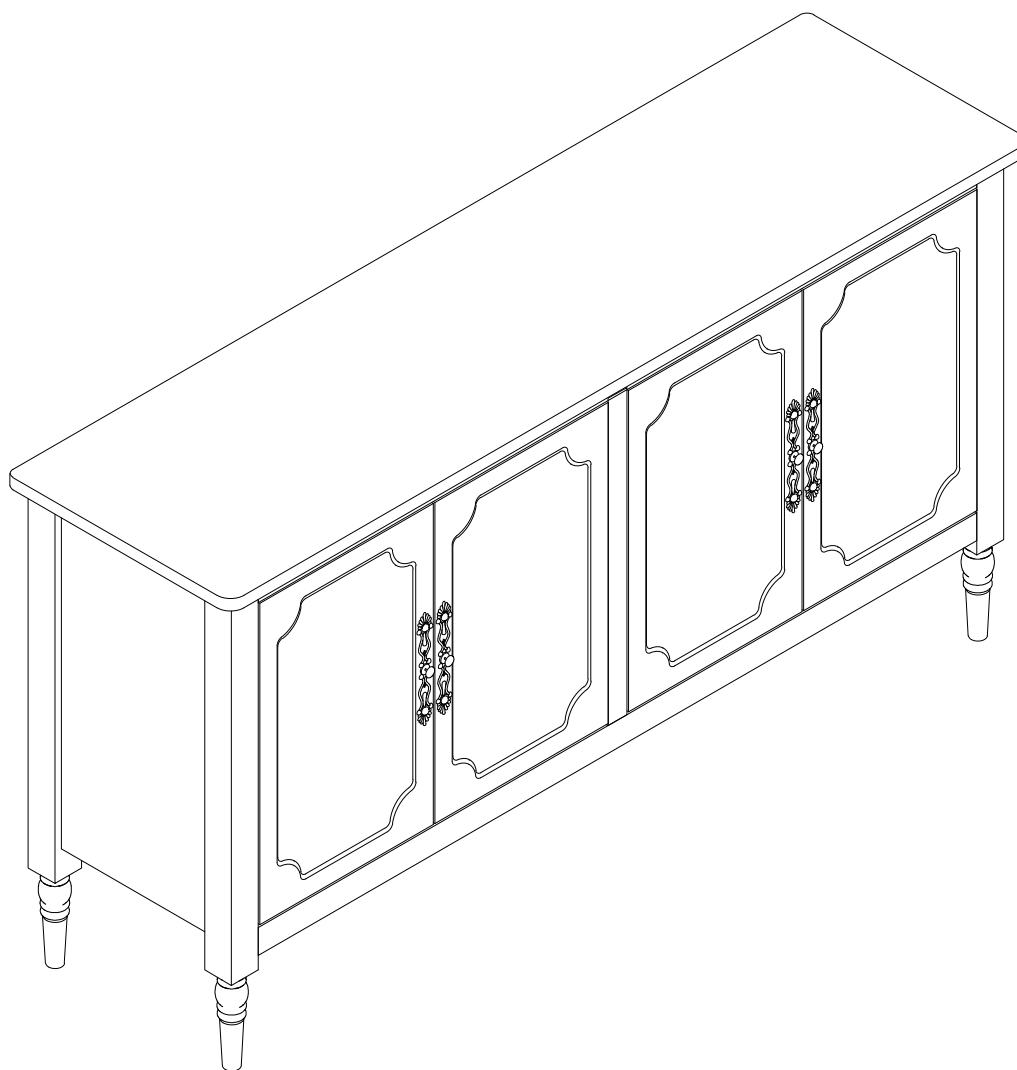

INSTRUCTION MANUAL

Contact Information

Question about your product? We're here to help. Contact us by:



707-392-8405



support@royalcraft.store

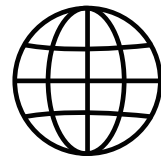

www.royalcraft.store



Orders FAQ



Product Assembly



Product Inquiry



Chat Support



Returns & Refunds

If you have any problems, please send your order number and photos to us .
We will contact you within 24 hours and provide you with a satisfactory solution.

NOTICE Please retain these instructions for future reference.

- Carefully unpack all the components and verify that all the necessary parts are included as listed in the packaging.
- Identify each component and refer to the provided assembly diagram or step-by-step instructions.
- Assemble the furniture in the order specified to ensure proper alignment and fit.
- Use the provided tools or recommended tools for assembly. Do not use excessive force when tightening screws or bolts.
- If any difficulties arise during assembly. Consult the troubleshooting section or contact our customer support.

Watch&Learn

For ASSEMBLY videos and MAINTAIN tips



You can visit royalcraft.store

Or scan the QR

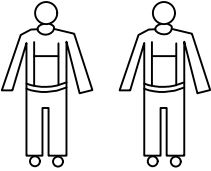

ASSEMBLY INSTRUCTIONS

2 people

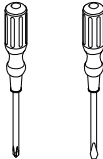
Phillips Screwdriver

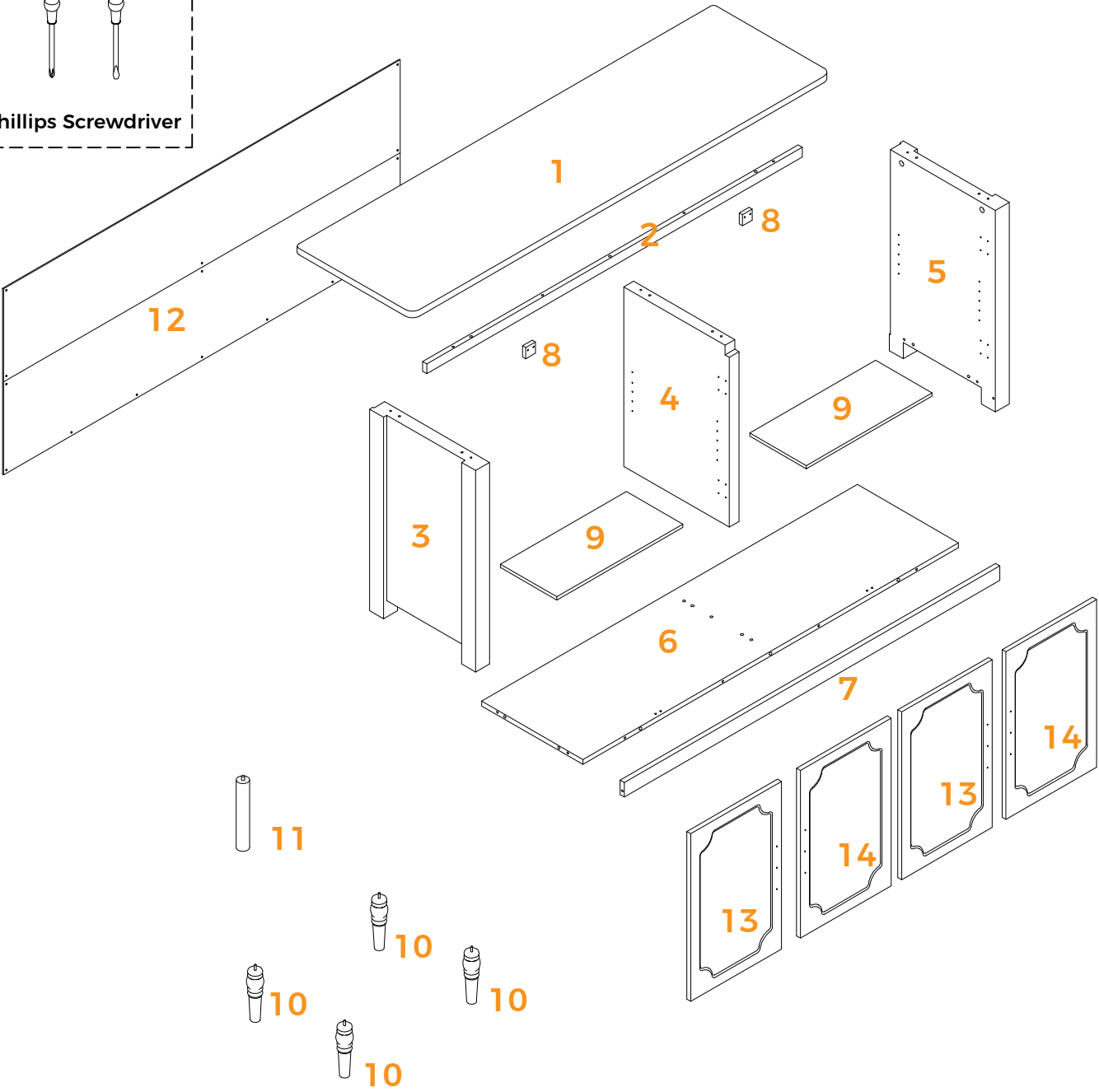



PARTS LIST

01

Top Panel

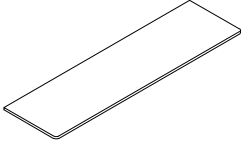

1 PC

02

Lower Front End Apron

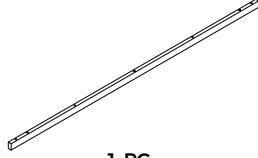

1 PC

03

Left Side Panel

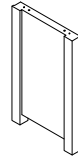

1 PC

04

Partition Board

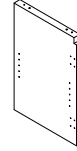

1 PC

05

Right Side Panel

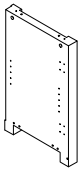

1 PC

06

Bottom Panel

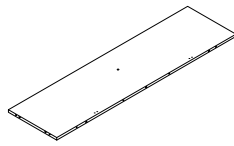

1 PC

07

Bottom Apron

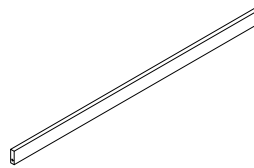

1 PC

08

Wooden Door Stop



2 PCS

09

Shelf Board

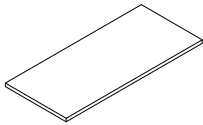

2 PCS

10

Foot



4 PCS

11

Middle Foot



1 PC

12

Back Panel

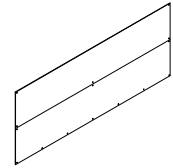

1 PC

13

Door

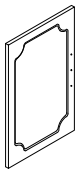

2 PCS





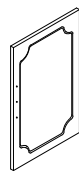





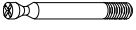







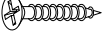
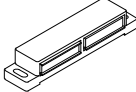

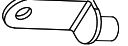

14

Door



2 PCS

☰ HARDWARE LIST

A Ø6×27mm Washer  18+1 PCS	B Ø15×9.5mm Washer  18+1 PCS	C Ø6×30mm Wooden Dowel  18+1 PCS	D FA4×35mm Screw  4 PCS	E Metal Piece  4 PCS	F FA3×12mm Screw  4 PCS
G FA3×12mm Screw  13+1 PCS	H FA3×16mm Screw  8+1 PCS	I FA3.5×14mm Screw  48+1 PCS	J Magnet  2 PCS	K 26Ø Hinge  8 PCS	L Shelf Support  8+1 PCS
M M4×22mm Screw  4 PCS	N Handle  4 PCS	O M4×14mm Screw  8+1 PCS	P FA4×12mm Screw  2 PCS	Q Anti-Tip Strap  2 PCS	R L-Shaped Iron Strip  4 PCS
S Anti Tipping Kit  2 PCS	T FA4×35mm Screw  2 PCS	U Buffer Pad  4 PCS	V FA3×14mm Screw  4 PCS	W Sticker  8+1 PCS	

⚠ If you are missing any parts, please provide your order number and circle the part number. Send us a photo of this, and we will provide you with a satisfactory solution. Thank you.

STEP 1

Please tighten the screws after
completing all installation.

Por favor, apriete los tornillos
después de instalar todo.

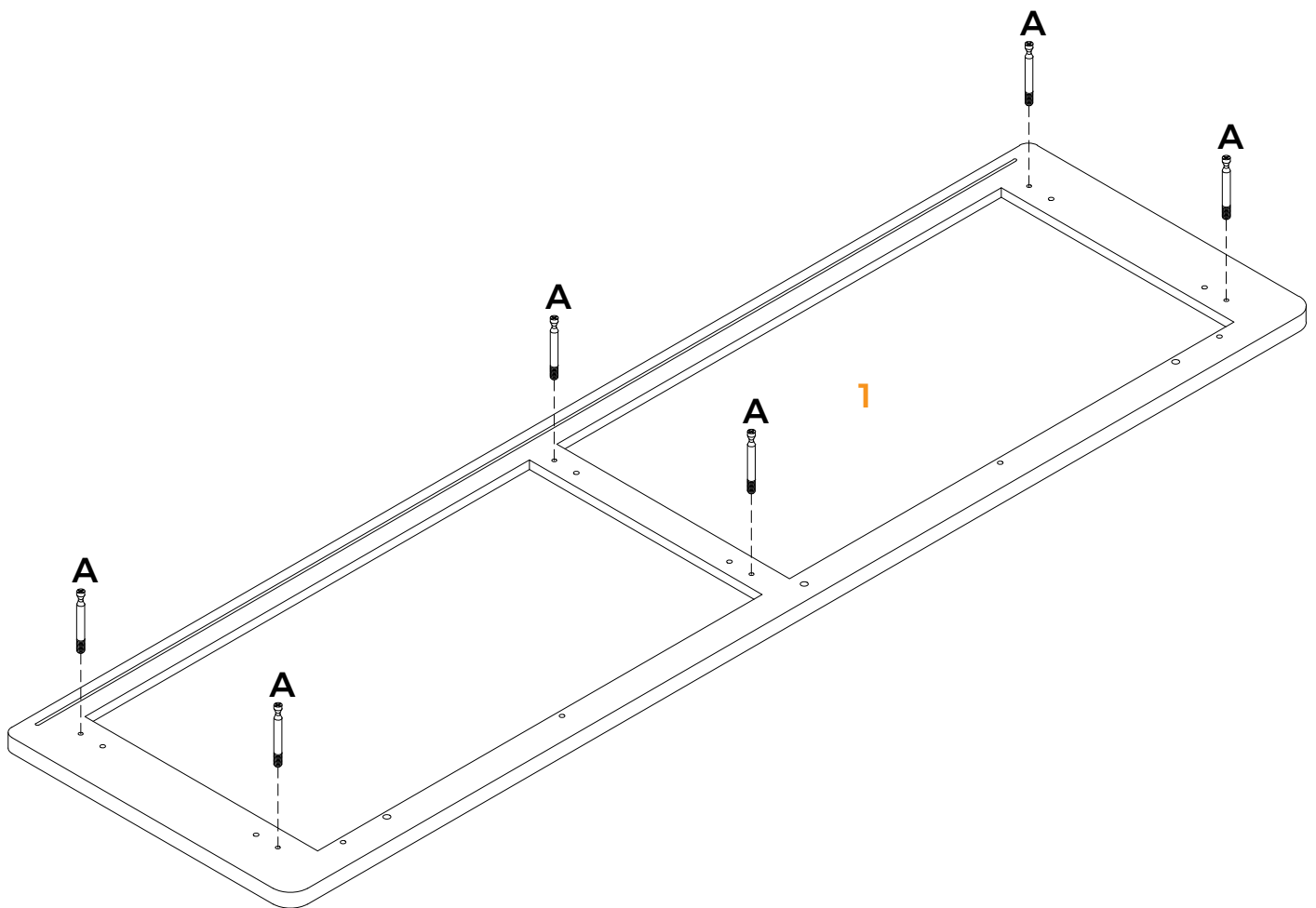
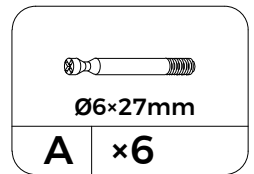
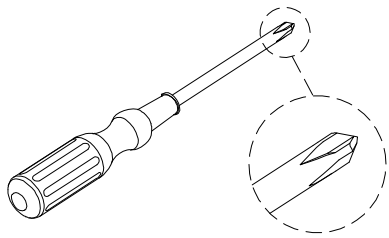

STEP 2

Please tighten the screws after completing all installation.

Por favor, apriete los tornillos después de instalar todo.

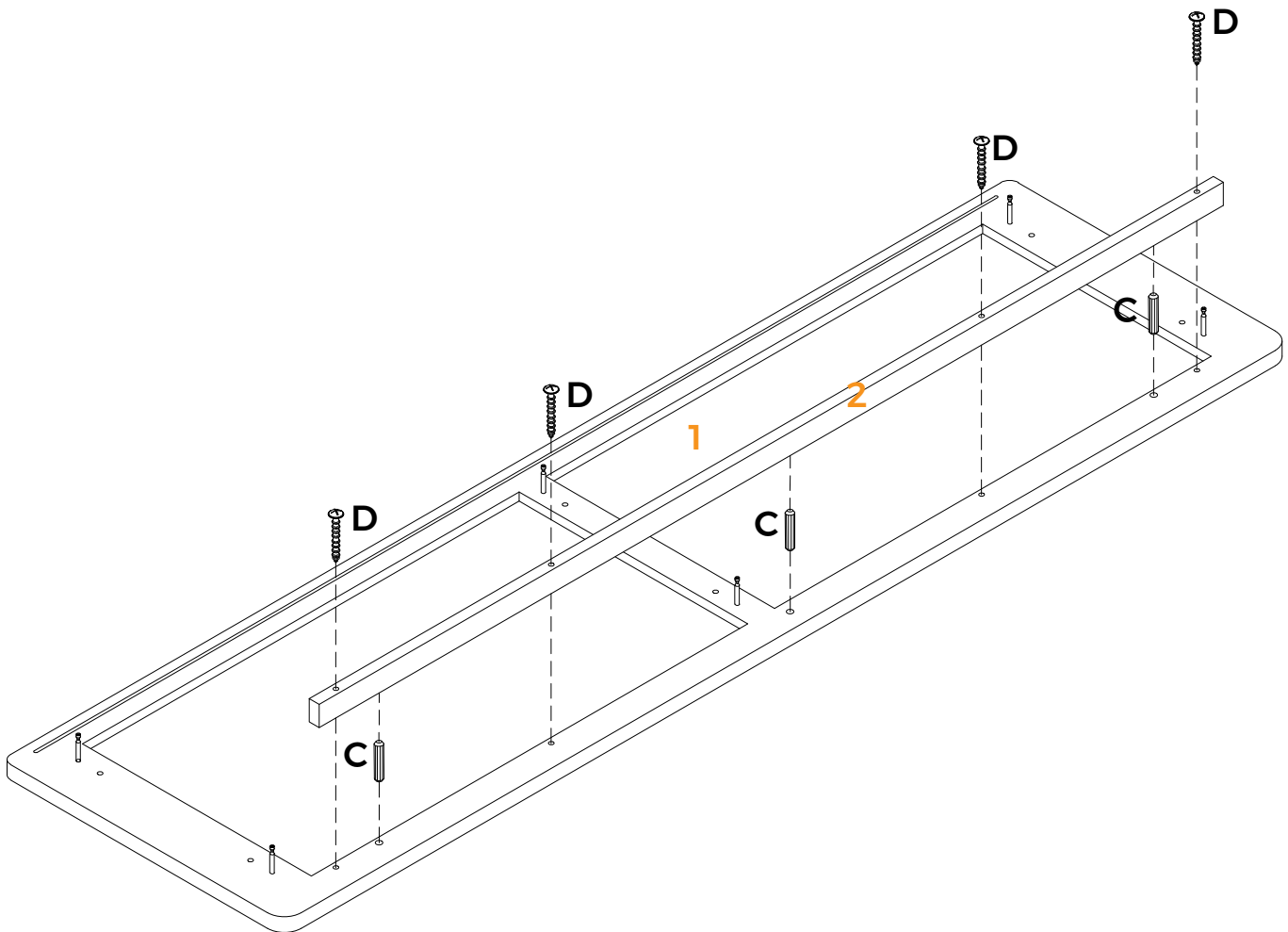
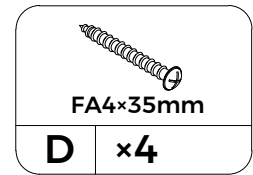
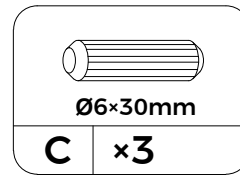
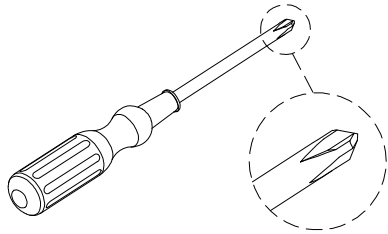

STEP 3

Please tighten the screws after completing all installation.

Por favor, apriete los tornillos después de instalar todo.

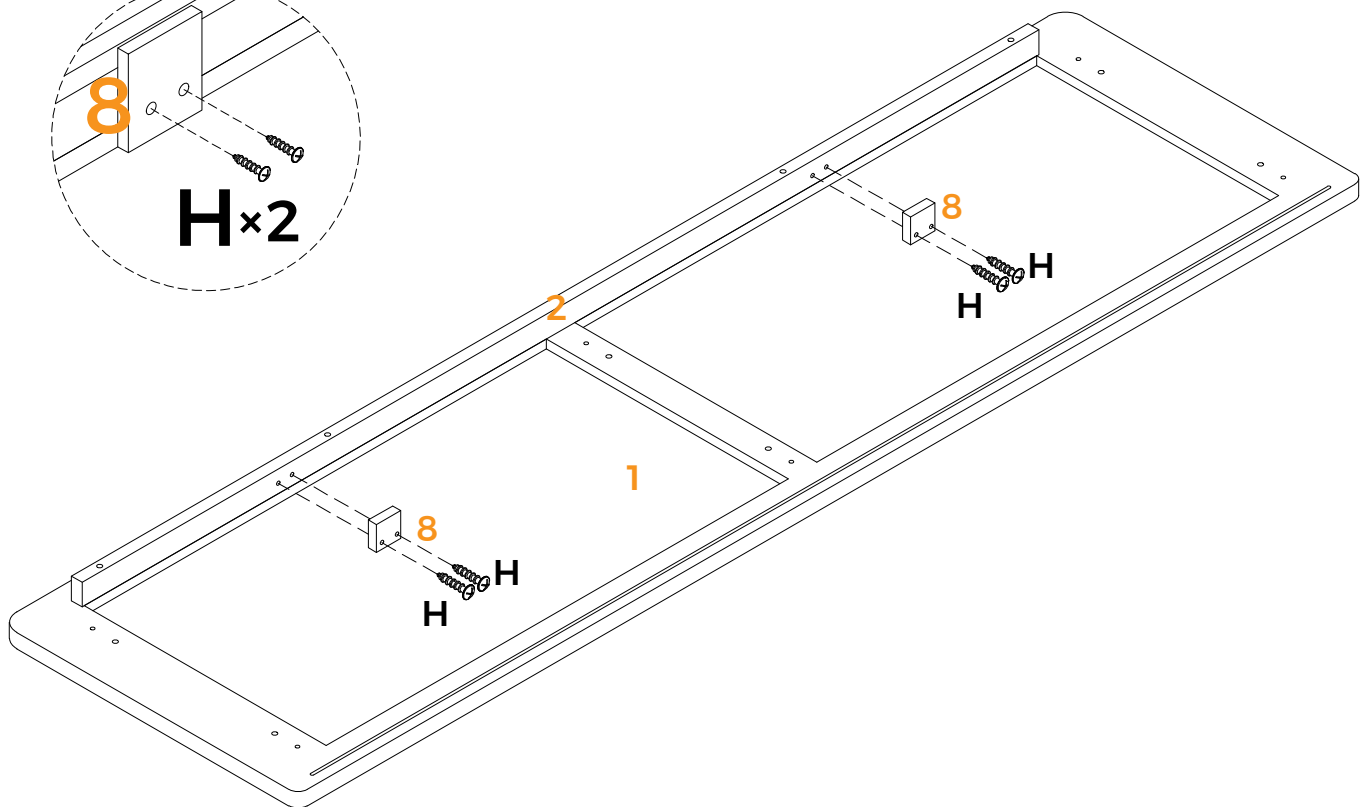
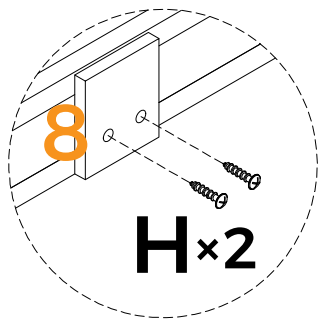
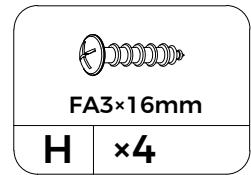
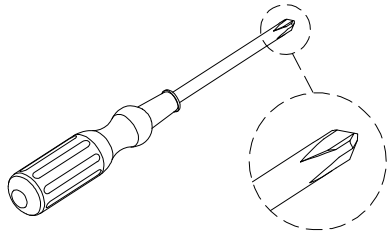

STEP 4

Please tighten the screws after
completing all installation.

Por favor, apriete los tornillos
después de instalar todo.

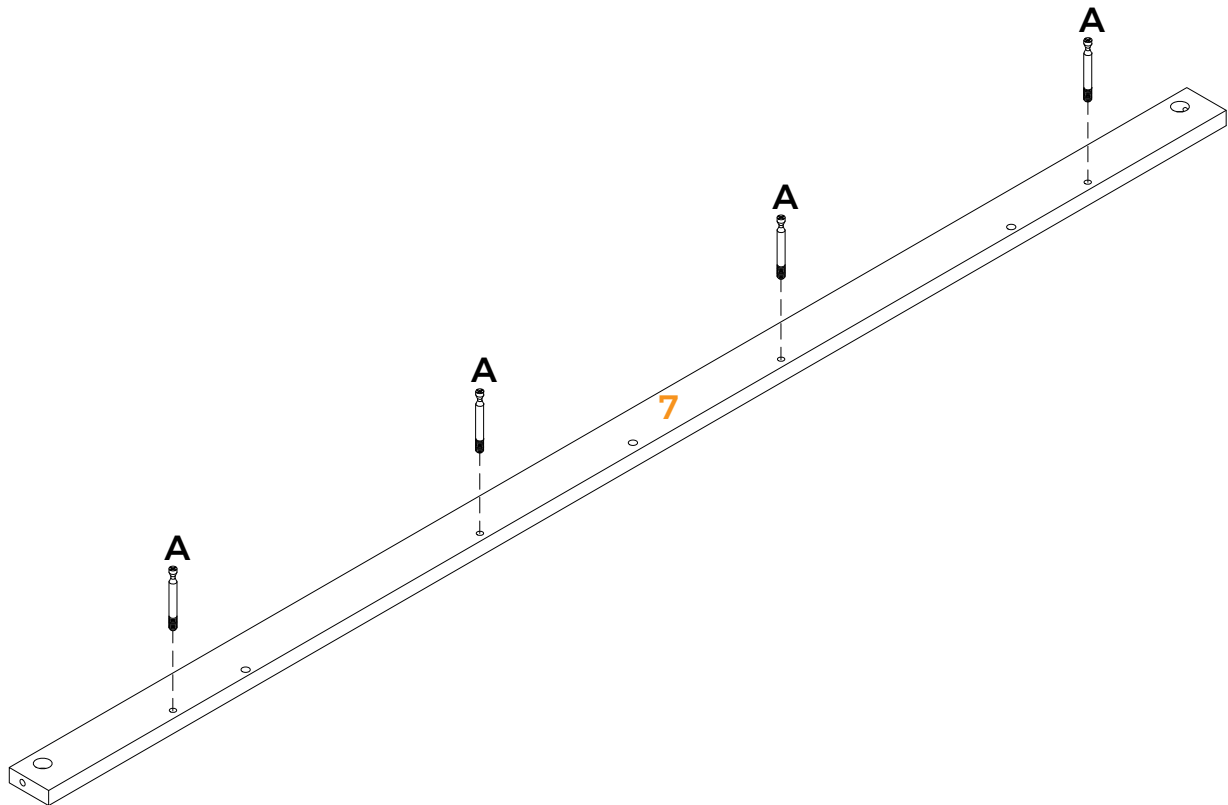
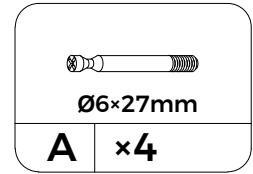
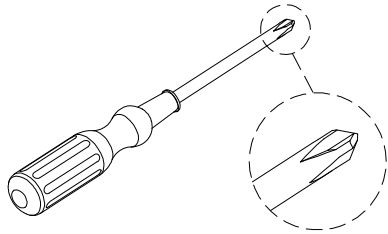

STEP 5

Please tighten the screws after completing all installation.

Por favor, apriete los tornillos después de instalar todo.

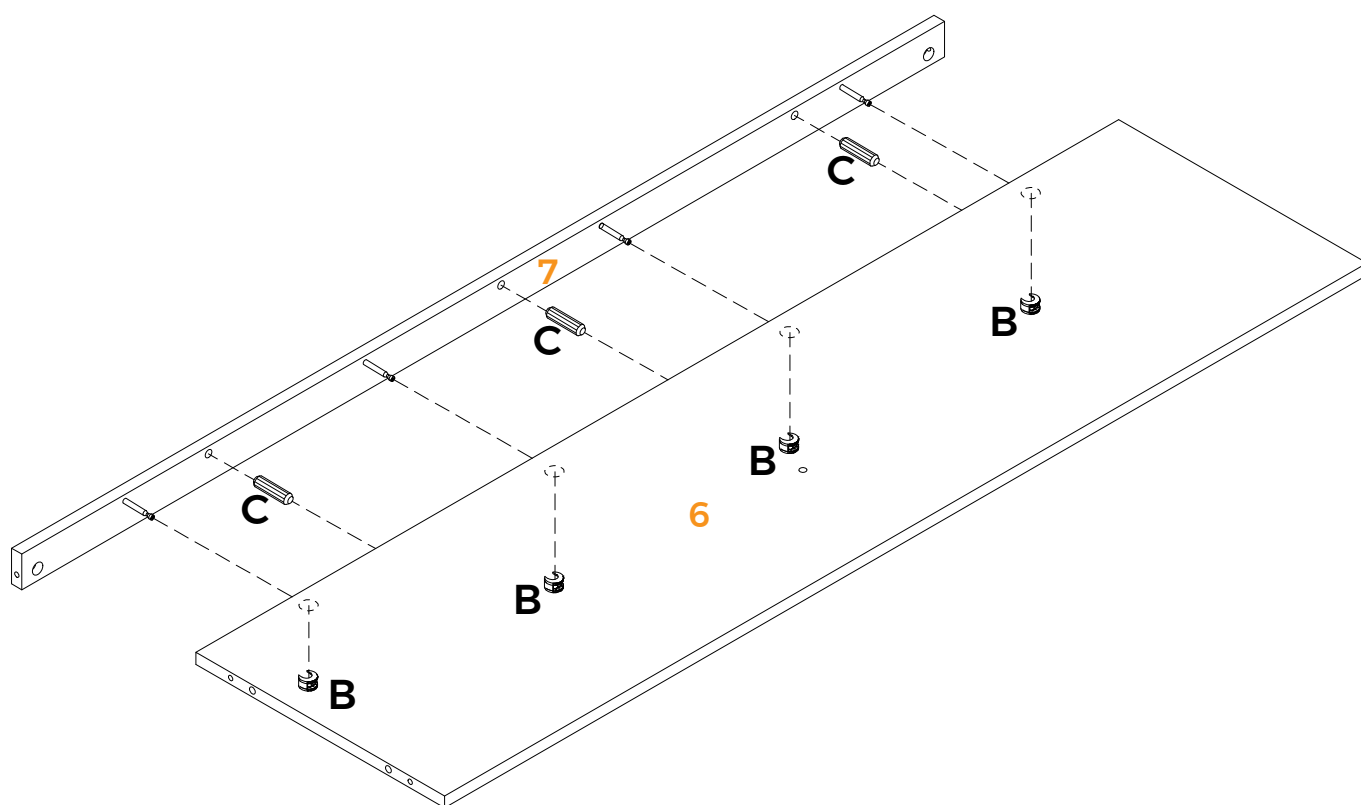
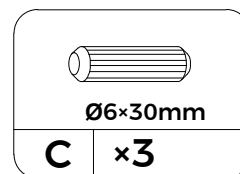
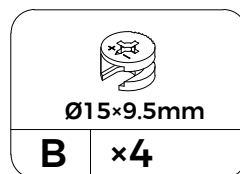

STEP 6

Please tighten the screws after completing all installation.

Por favor, apriete los tornillos después de instalar todo.

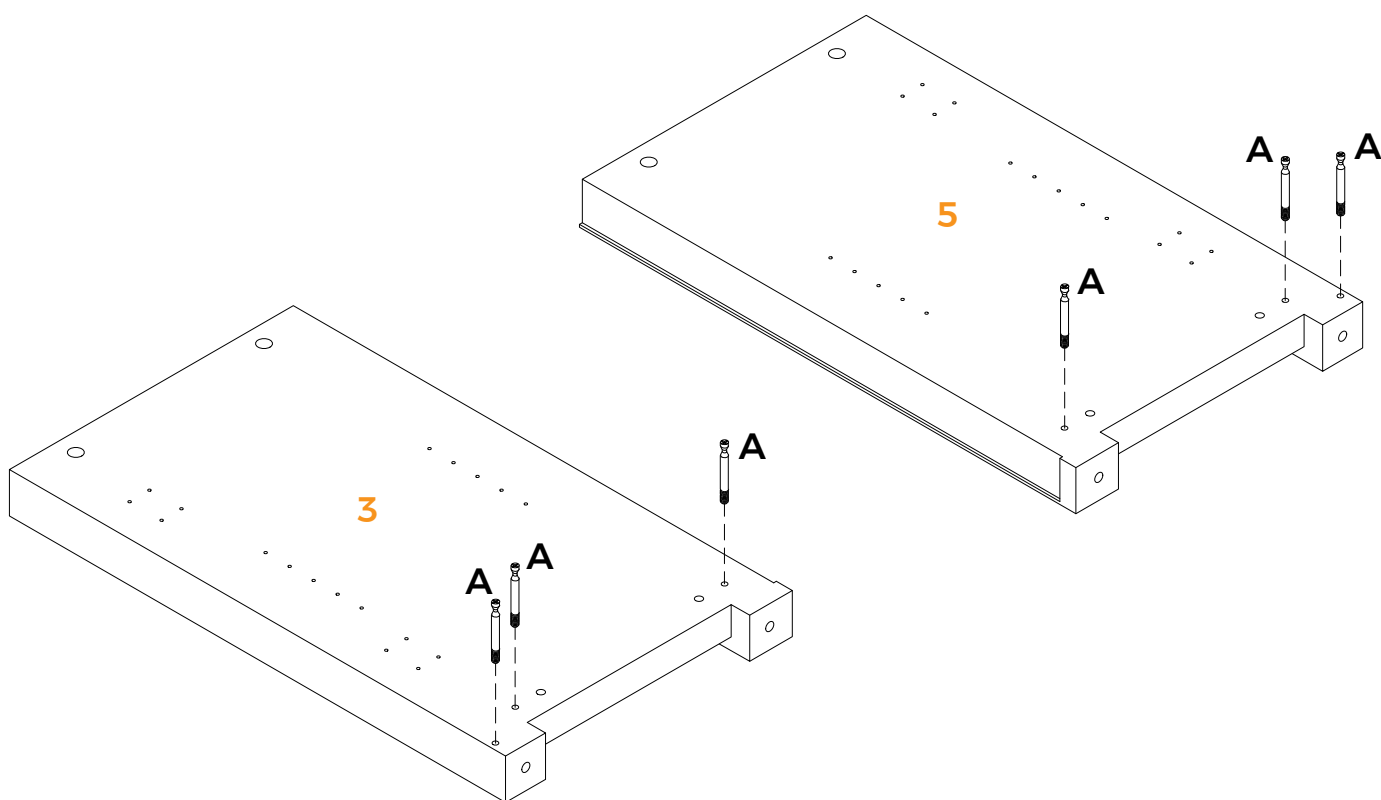
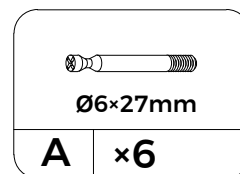
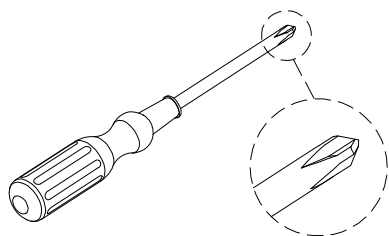

STEP 7

Please tighten the screws after completing all installation.

Por favor, apriete los tornillos después de instalar todo.

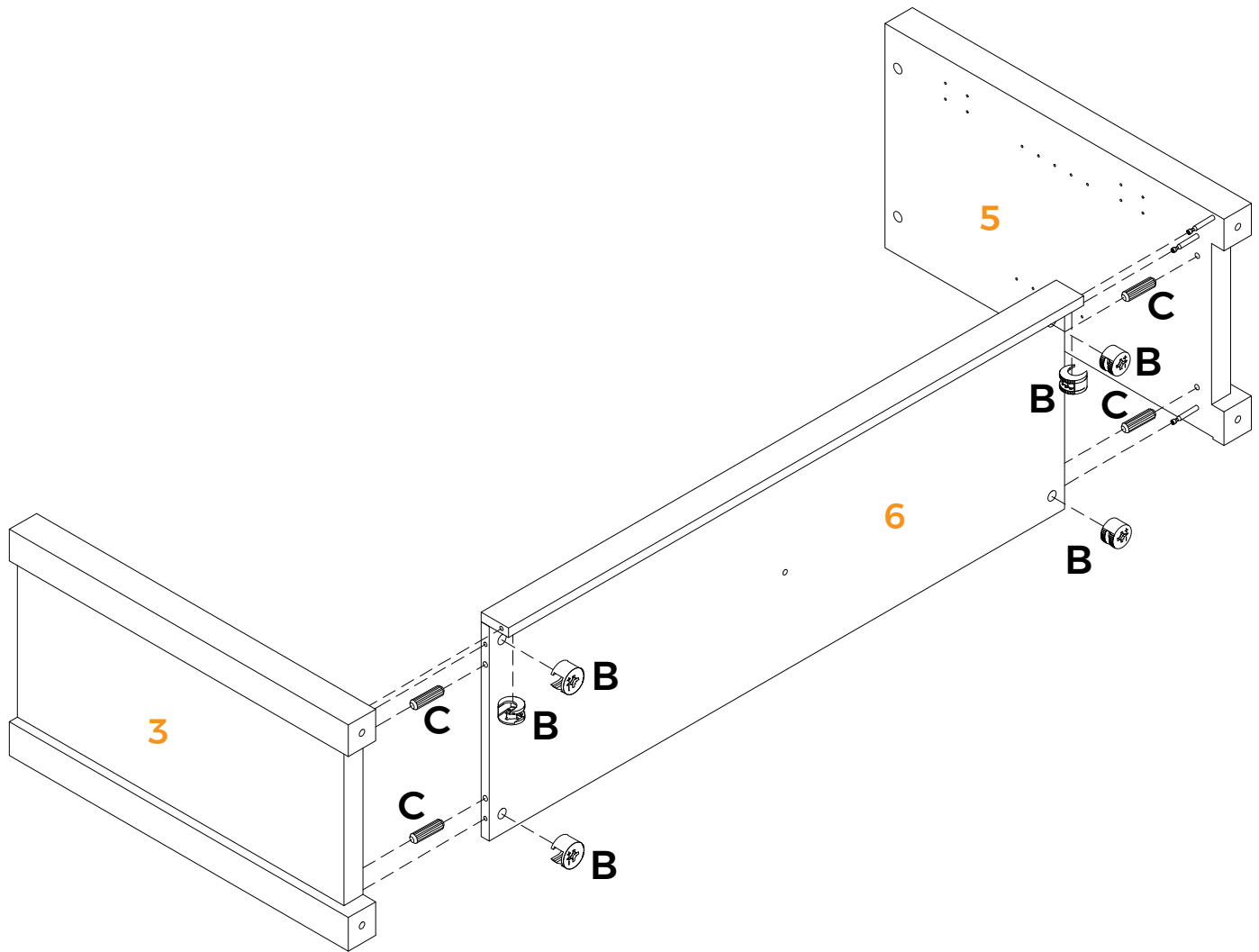
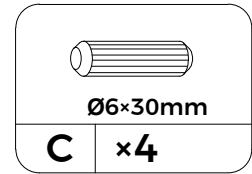
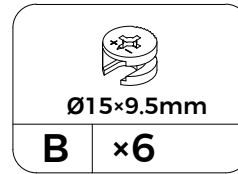

STEP 8

Please tighten the screws after completing all installation.

Por favor, apriete los tornillos después de instalar todo.

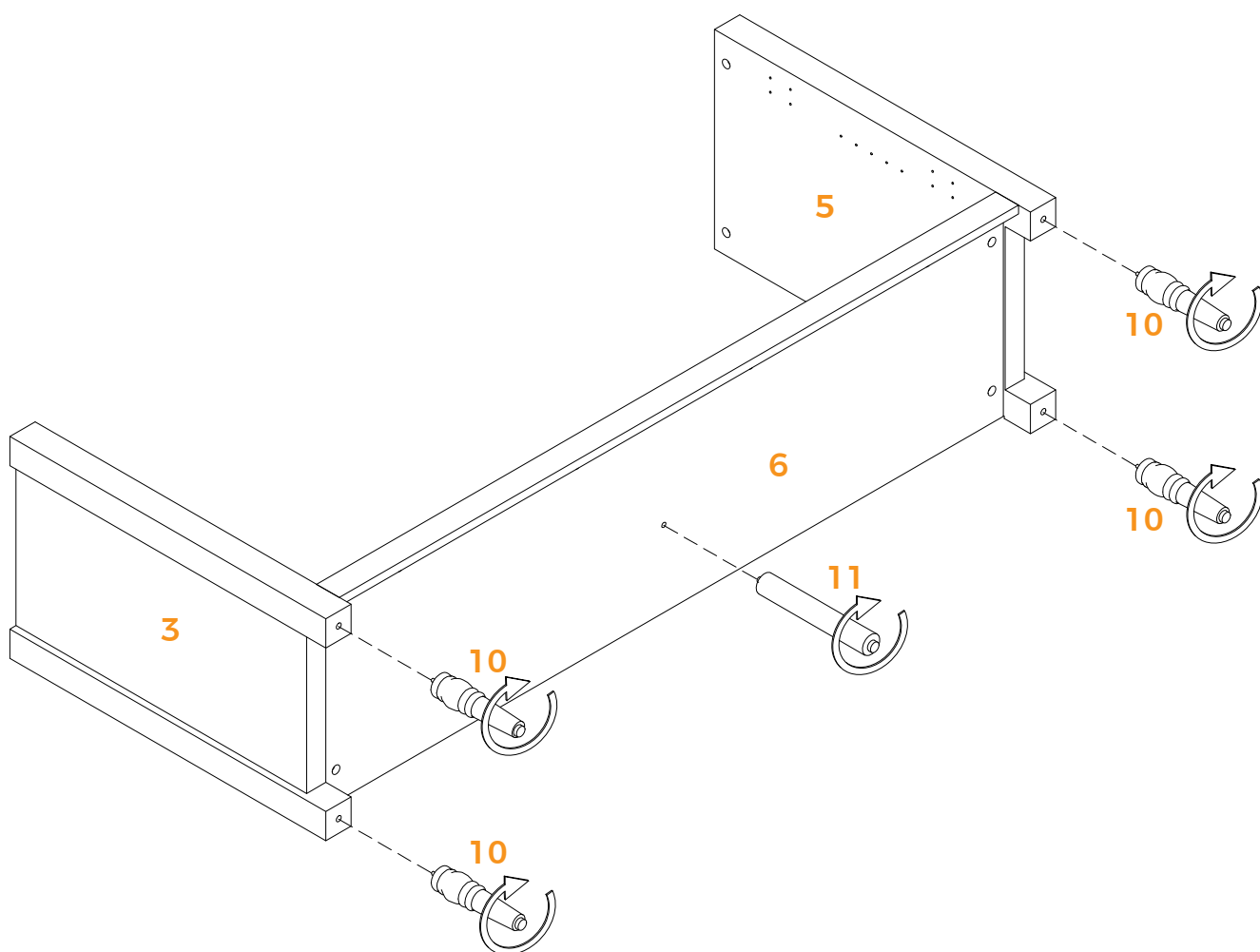

STEP 9

Please tighten the screws after completing all installation.

Por favor, apriete los tornillos después de instalar todo.

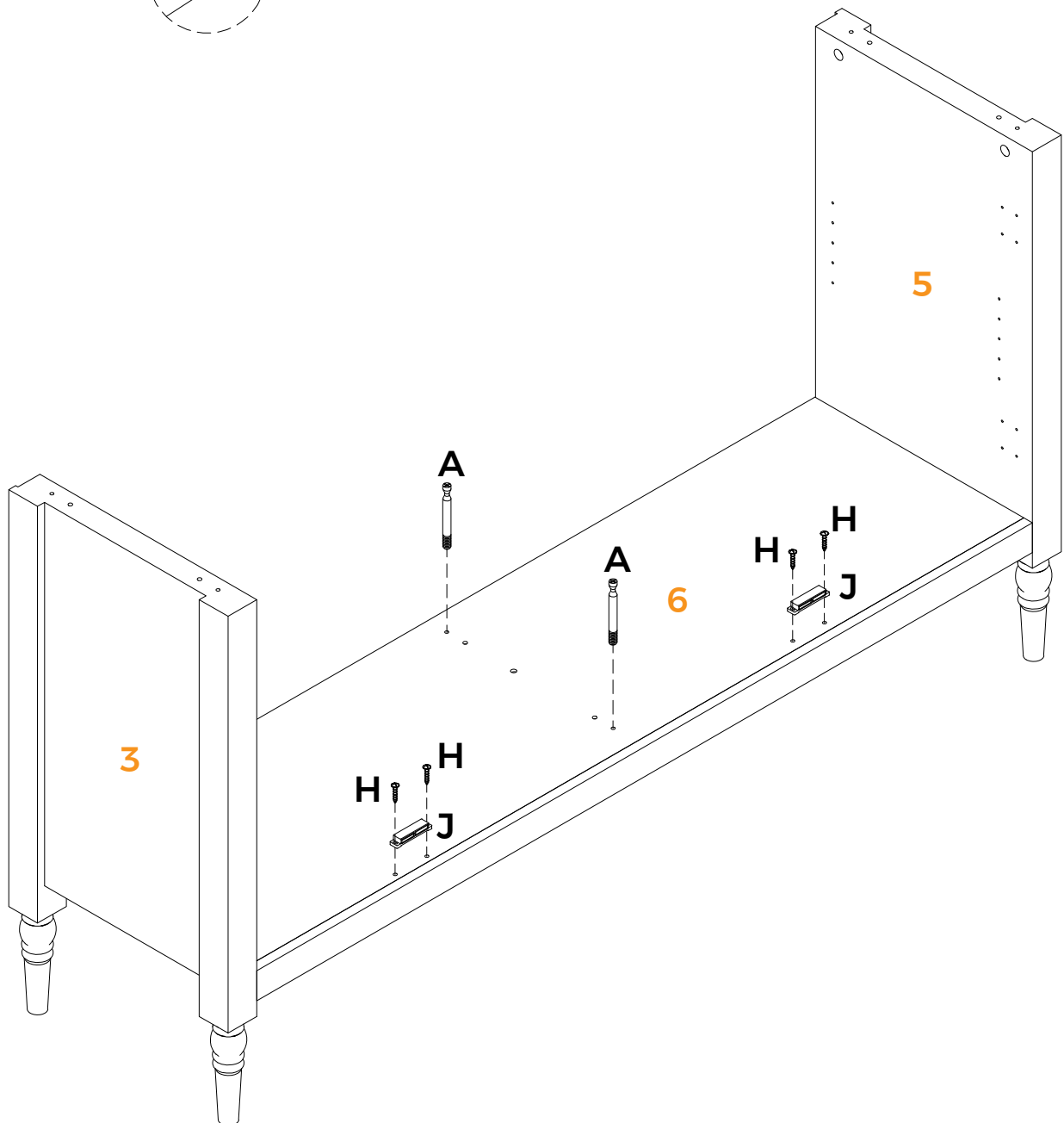
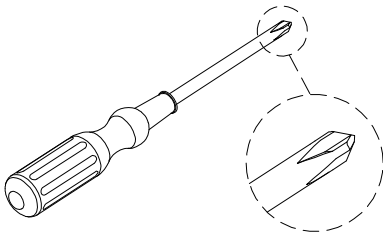
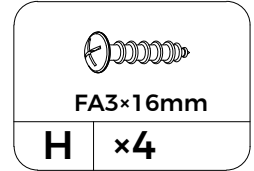
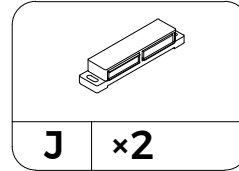
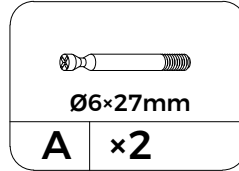

STEP 10

Please tighten the screws after completing all installation.

Por favor, apriete los tornillos después de instalar todo.

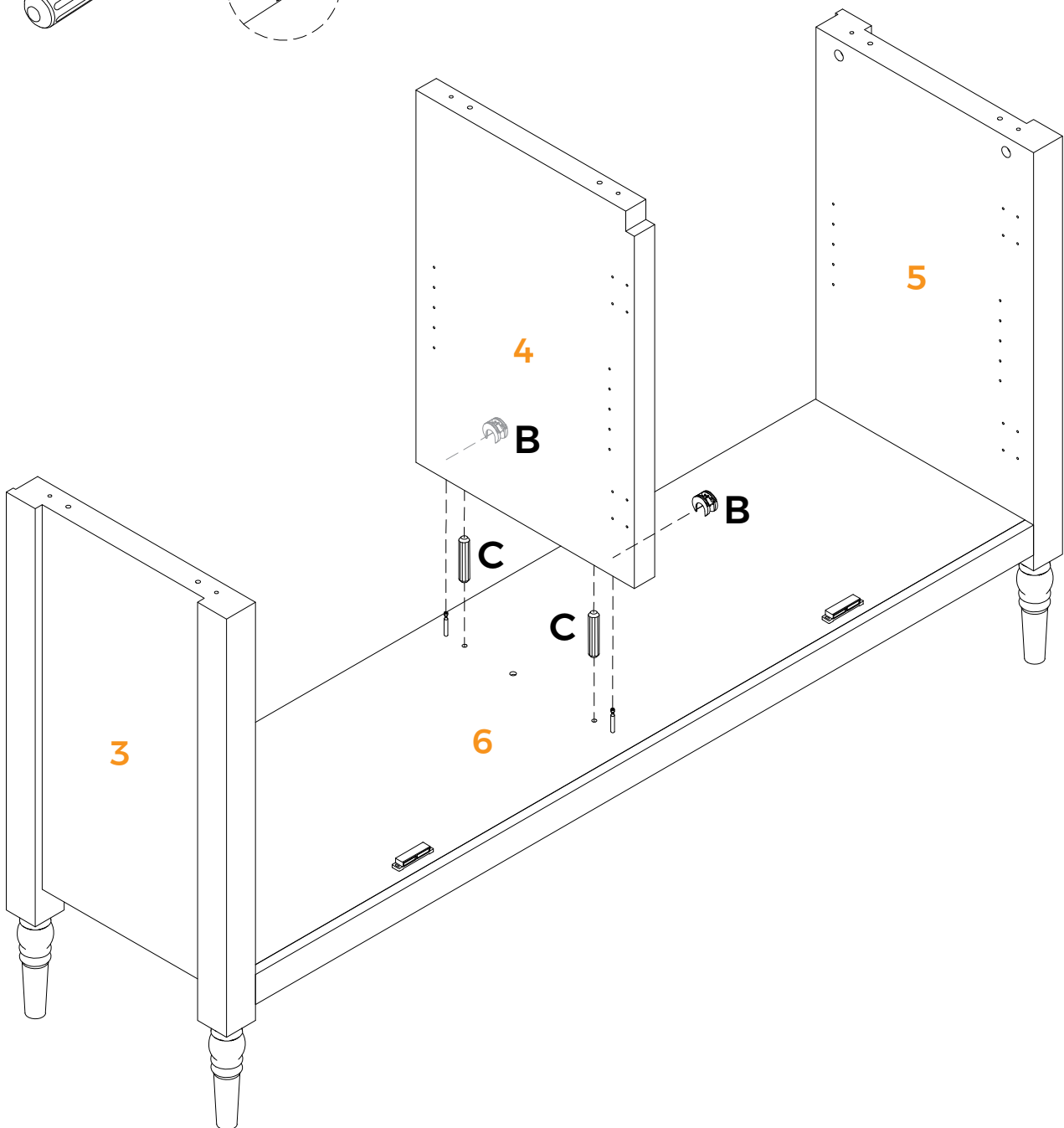
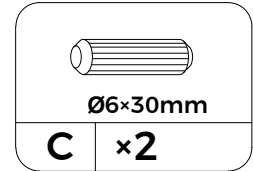
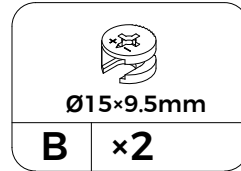
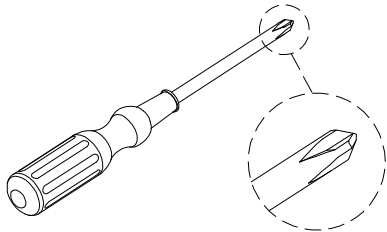

STEP 11

Please tighten the screws after completing all installation.

Por favor, apriete los tornillos después de instalar todo.

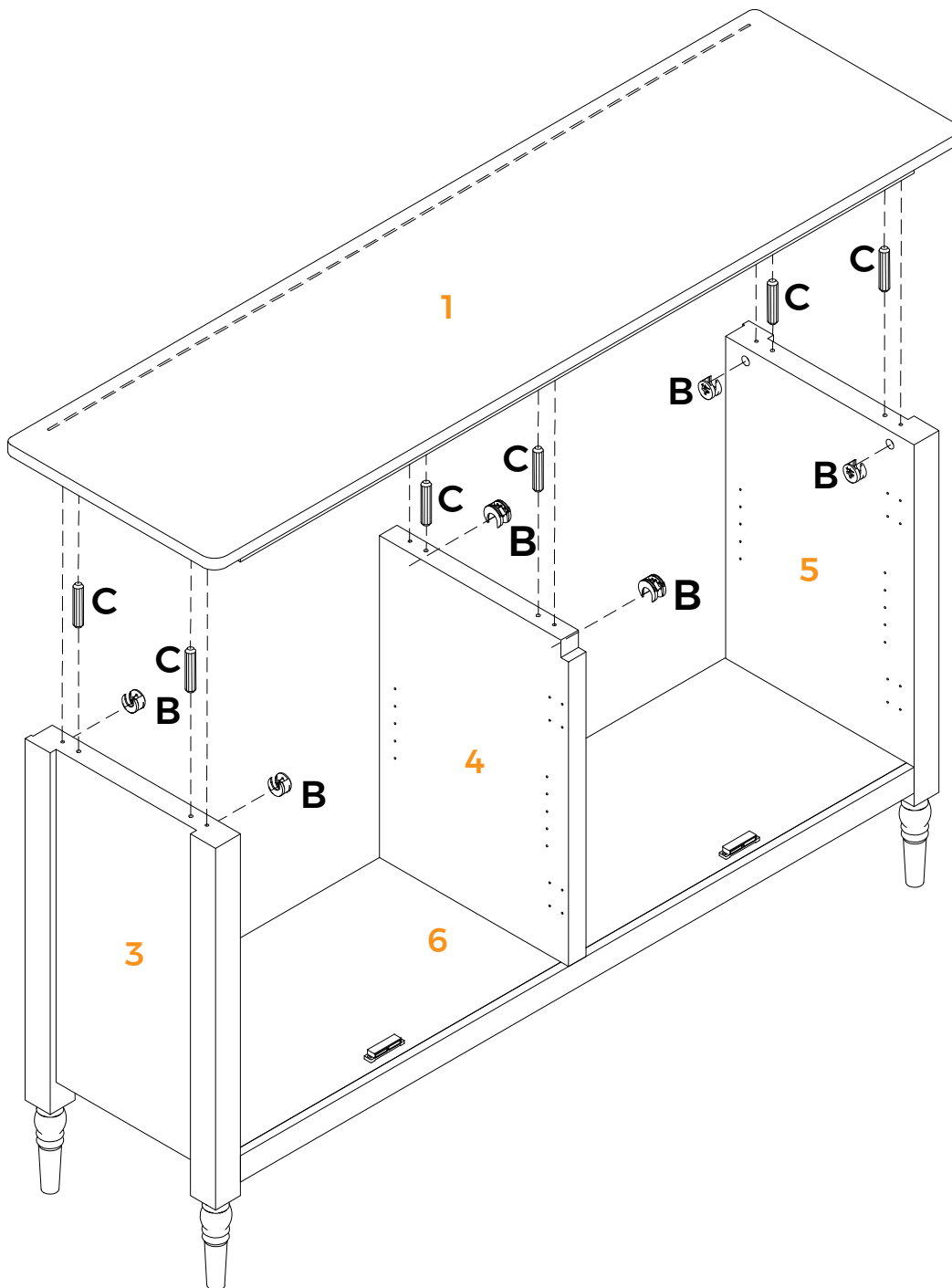
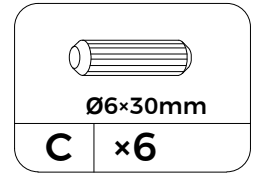
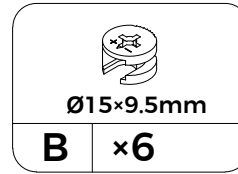

STEP 12

Please tighten the screws after completing all installation.

Por favor, apriete los tornillos después de instalar todo.

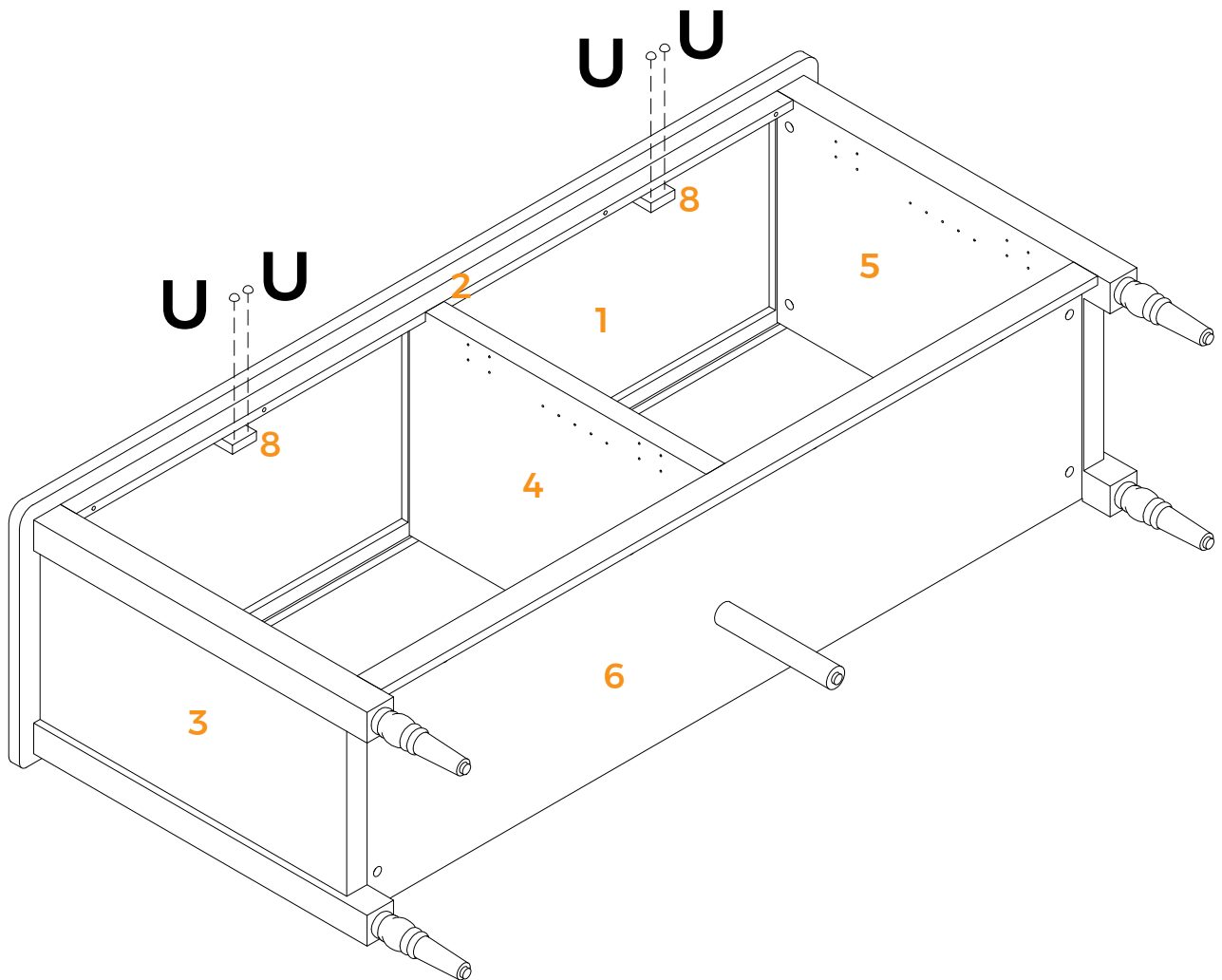
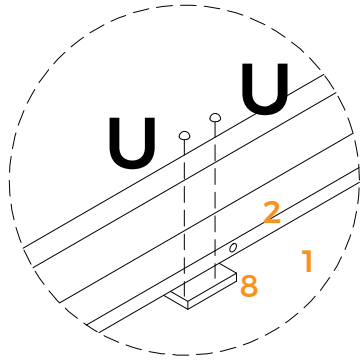
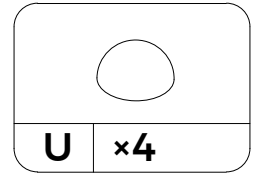

STEP 13

Please tighten the screws after completing all installation.

Por favor, apriete los tornillos después de instalar todo.

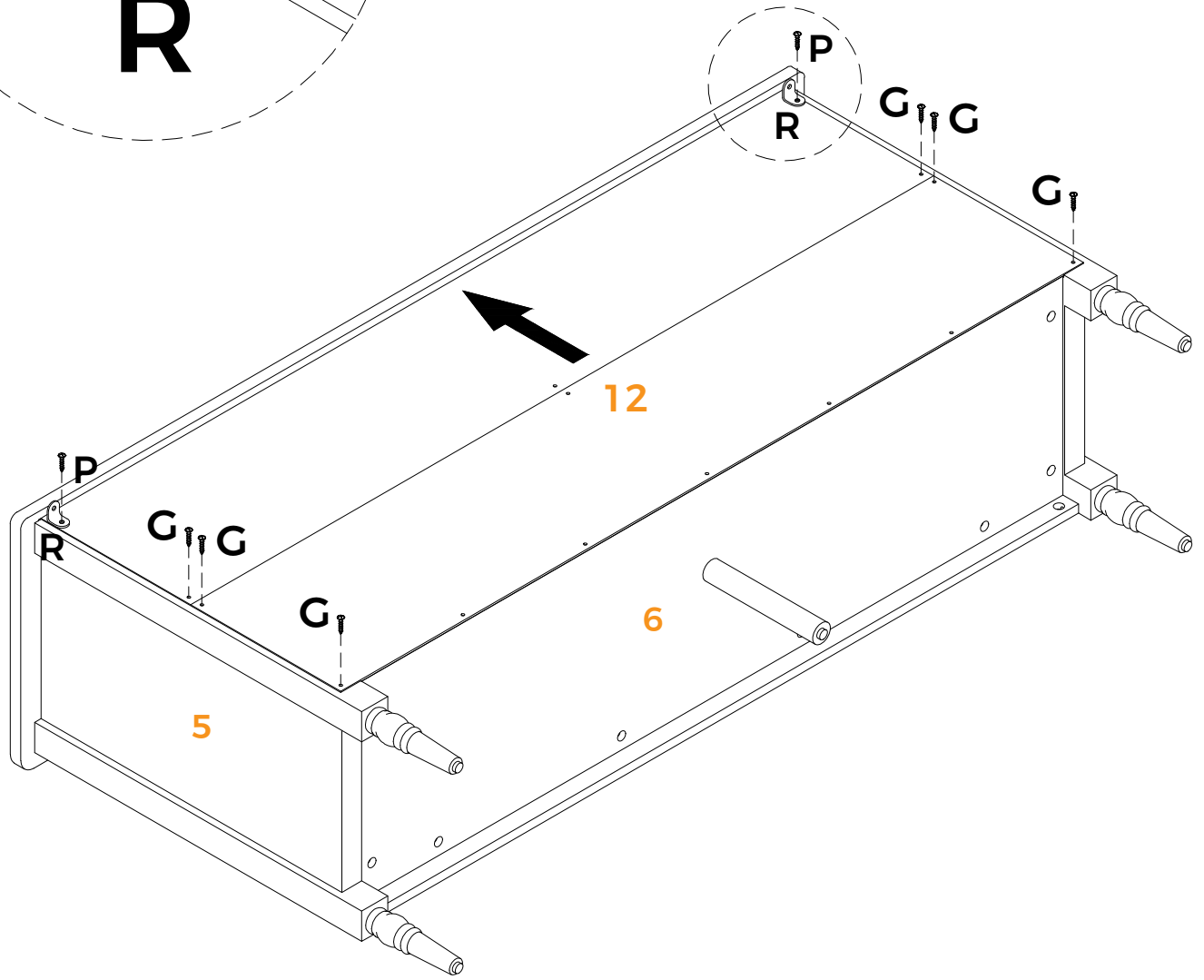
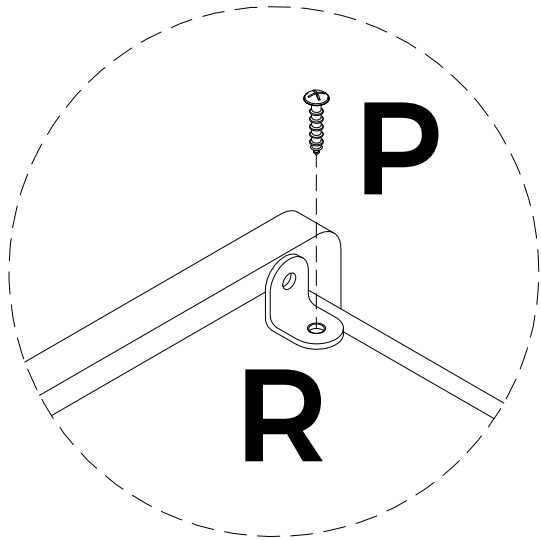
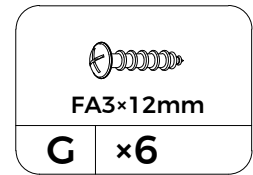
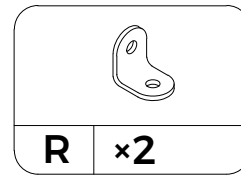
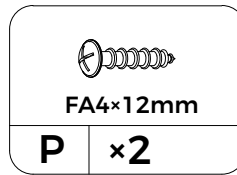

STEP 14

Please tighten the screws after completing all installation.

Por favor, apriete los tornillos después de instalar todo.

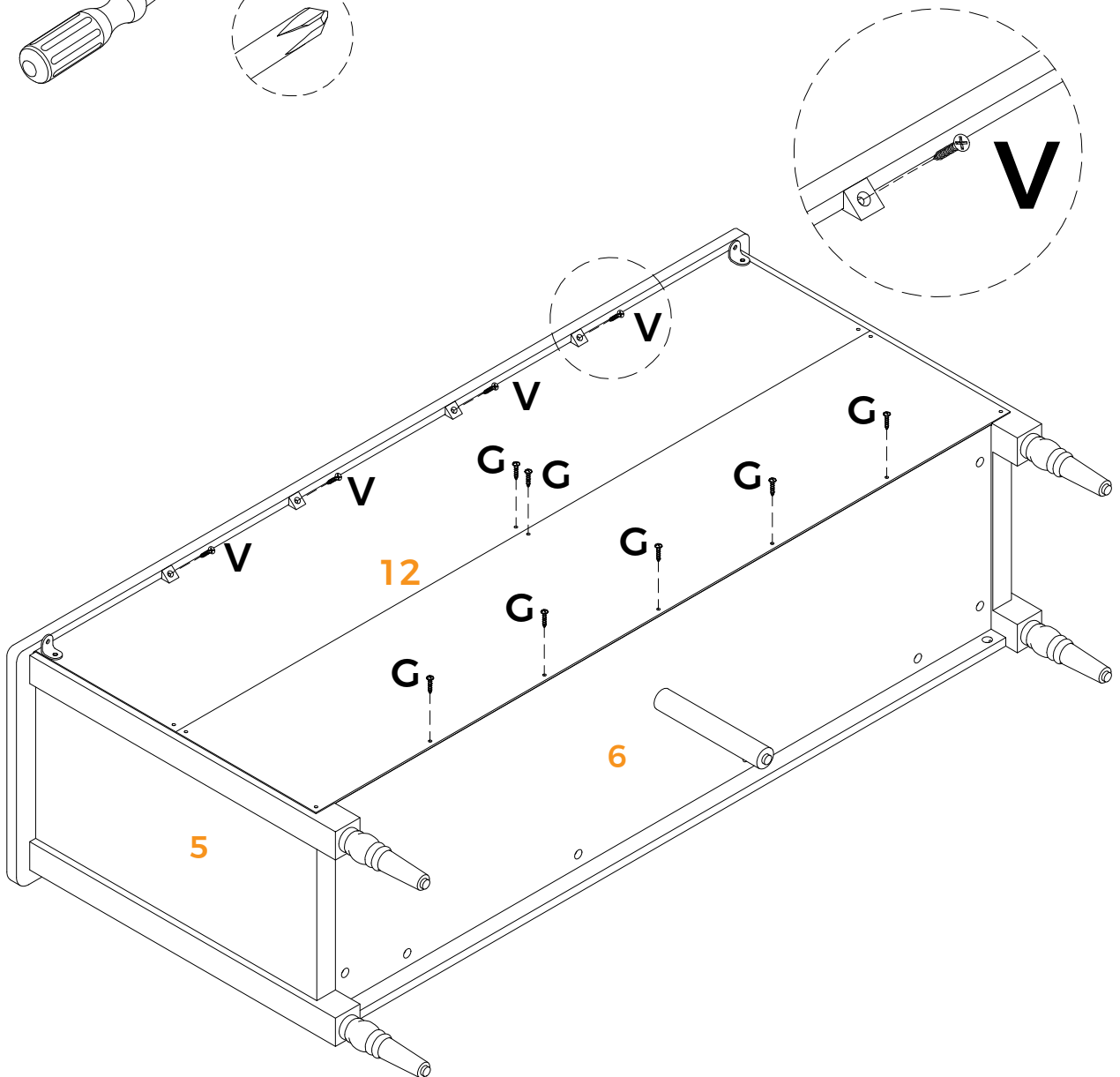
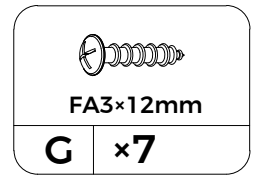
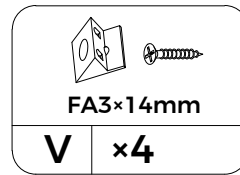
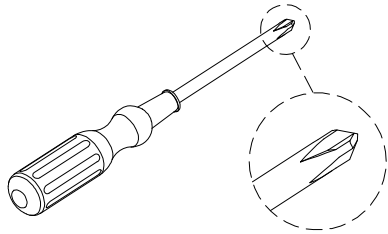

STEP 15

Please tighten the screws after completing all installation.

Por favor, apriete los tornillos después de instalar todo.

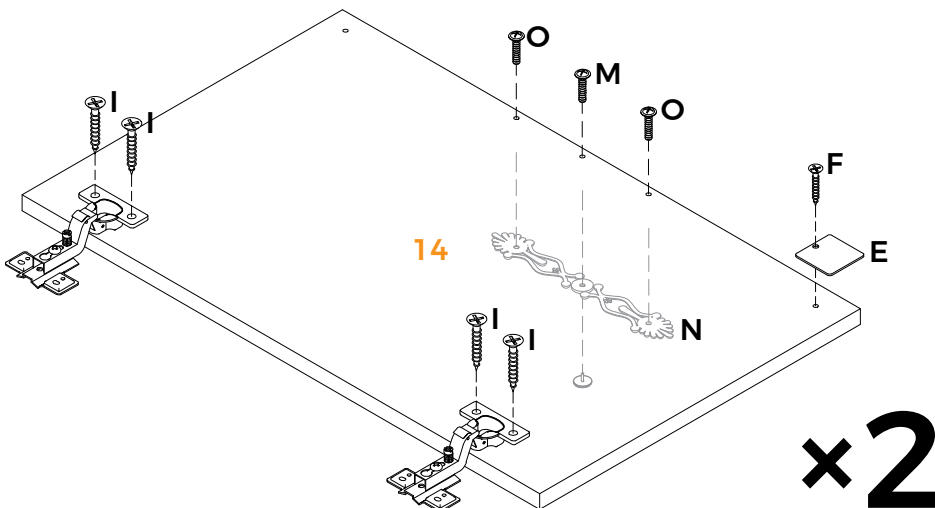
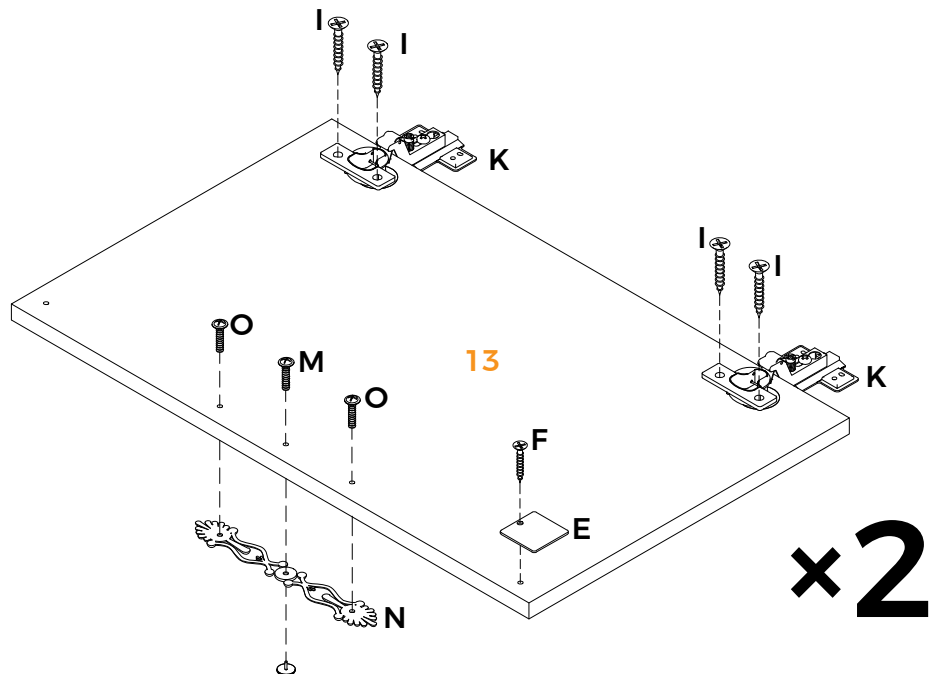
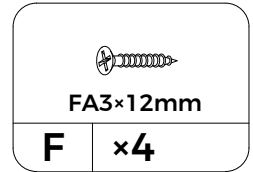
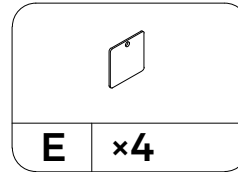
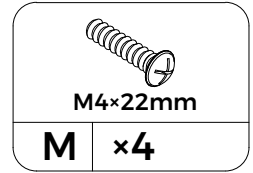
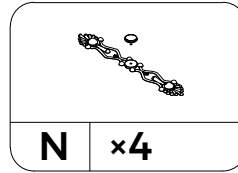
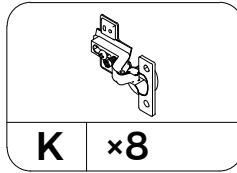
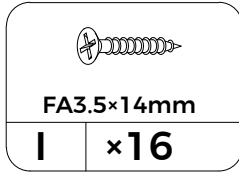
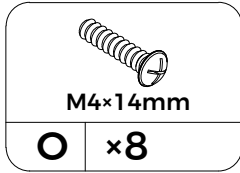

STEP 16

Please tighten the screws after completing all installation.

Por favor, apriete los tornillos después de instalar todo.

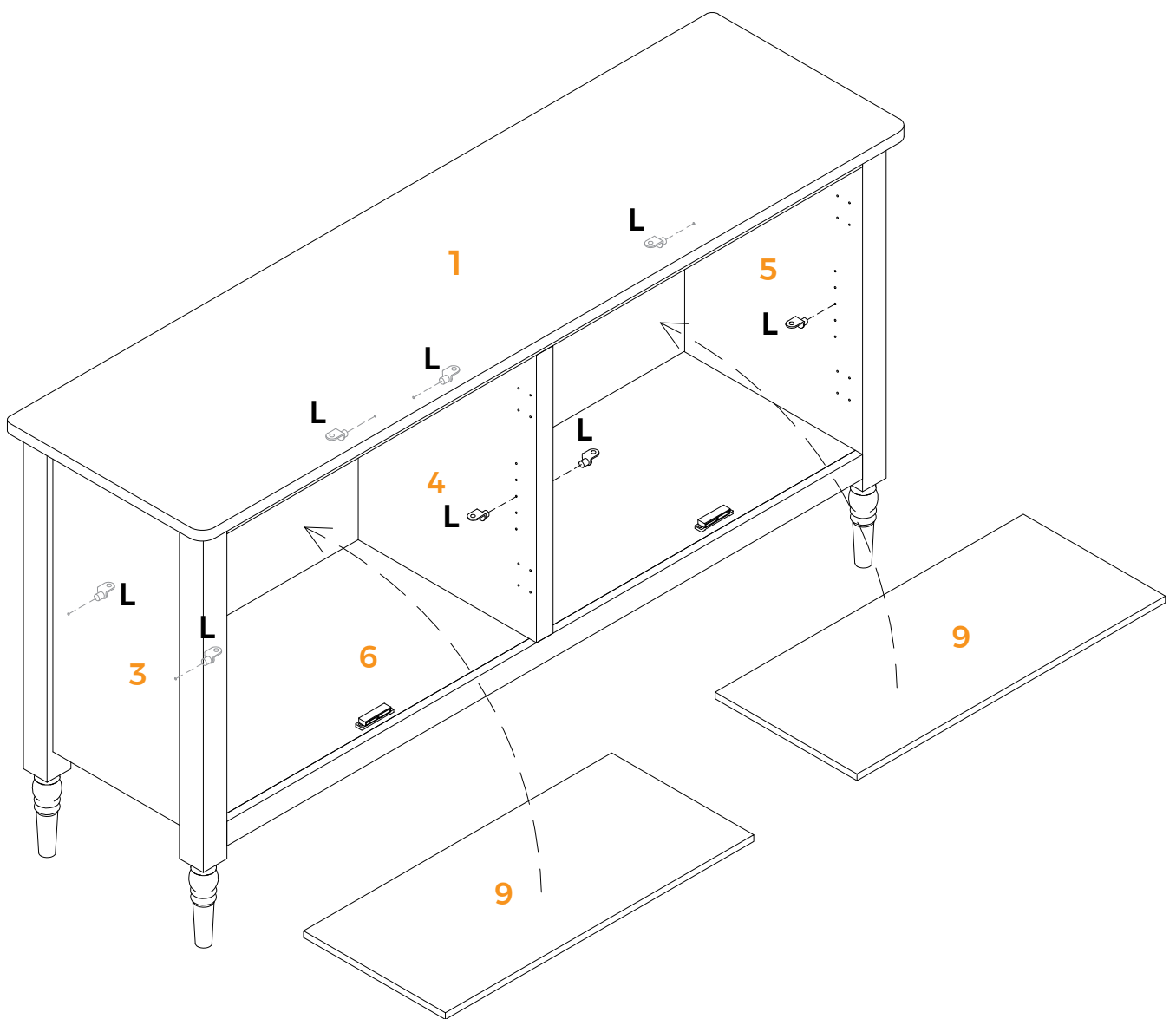
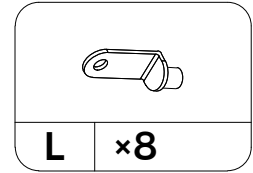

STEP 17

Please tighten the screws after completing all installation.

Por favor, apriete los tornillos después de instalar todo.

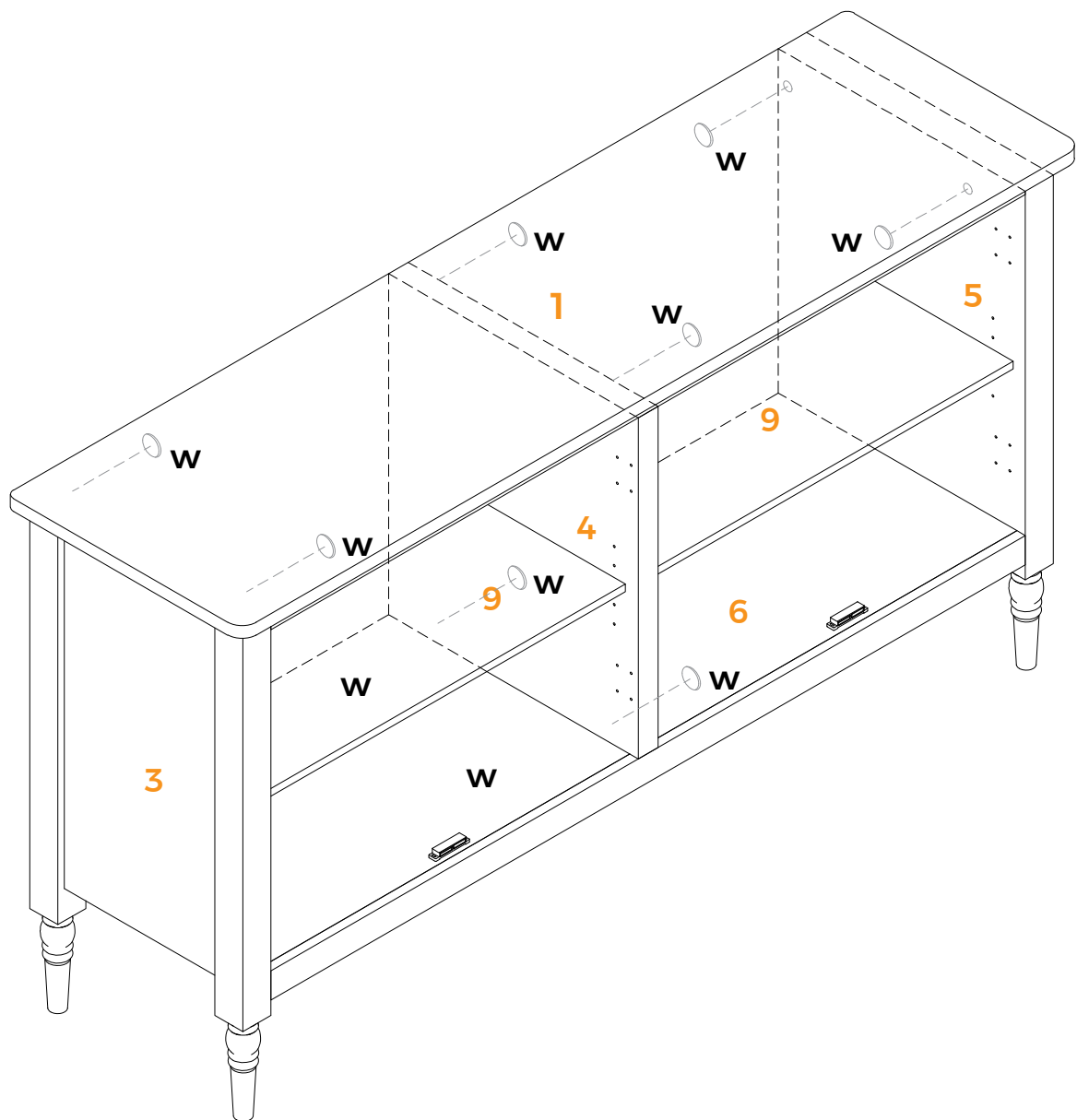
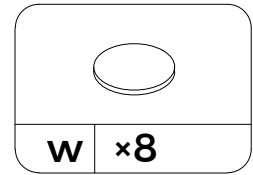

STEP 18

Please tighten the screws after completing all installation.

Por favor, apriete los tornillos después de instalar todo.

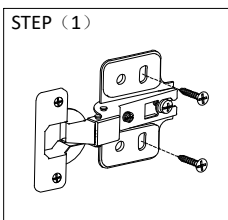
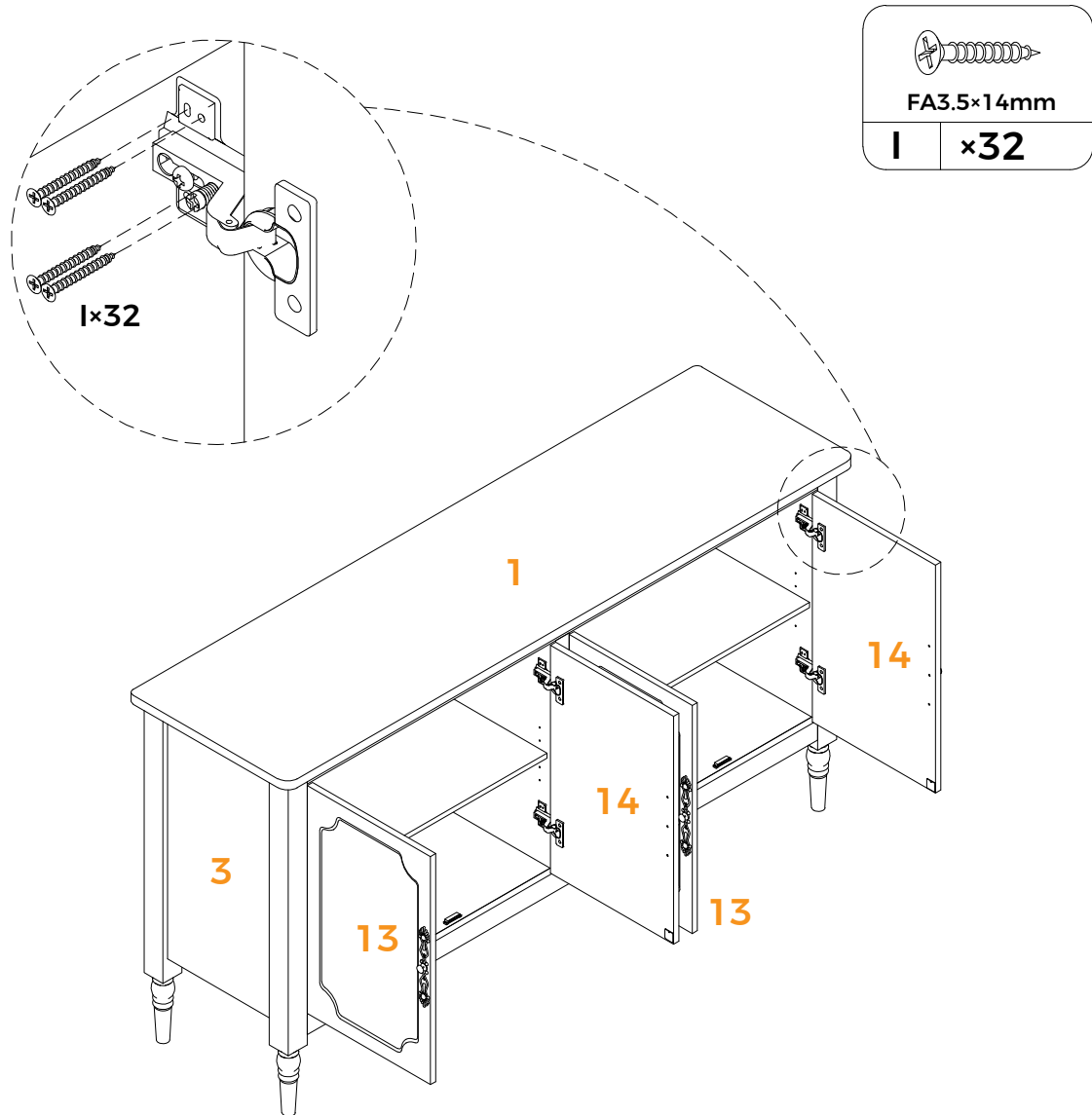

Tips: Turning the screw to approx 50% tightness, don't be fully tight.

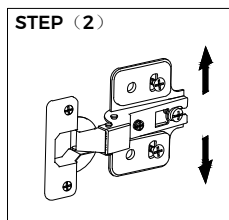

Tips: Moving the hinges up or down appropriately to adjust the gap between the door with the cabinet top and bottom.

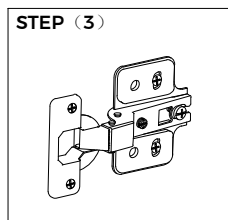

Tips: Tightening the screws completely.

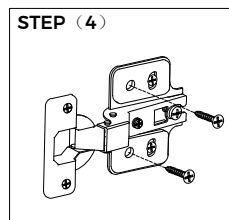

Tips: Tightening the other screws completely.

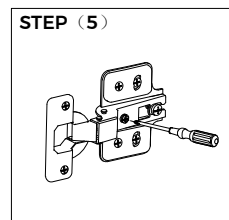

Tips: If the gap between the doors with the partition panel is too far or close, please turning the screw as shown below.

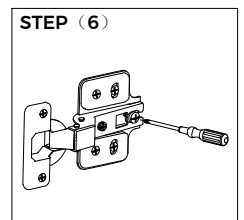

Tips: Adjusting the screw as shown in the following picture can make the door move forward or backward.

Tips: Adjusting the levelers appropriately underneath the bottom of the foot can make the gaps between the door and frames of cabinet even.

STEP 19

Please tighten the screws after completing all installation.

Por favor, apriete los tornillos después de instalar todo.

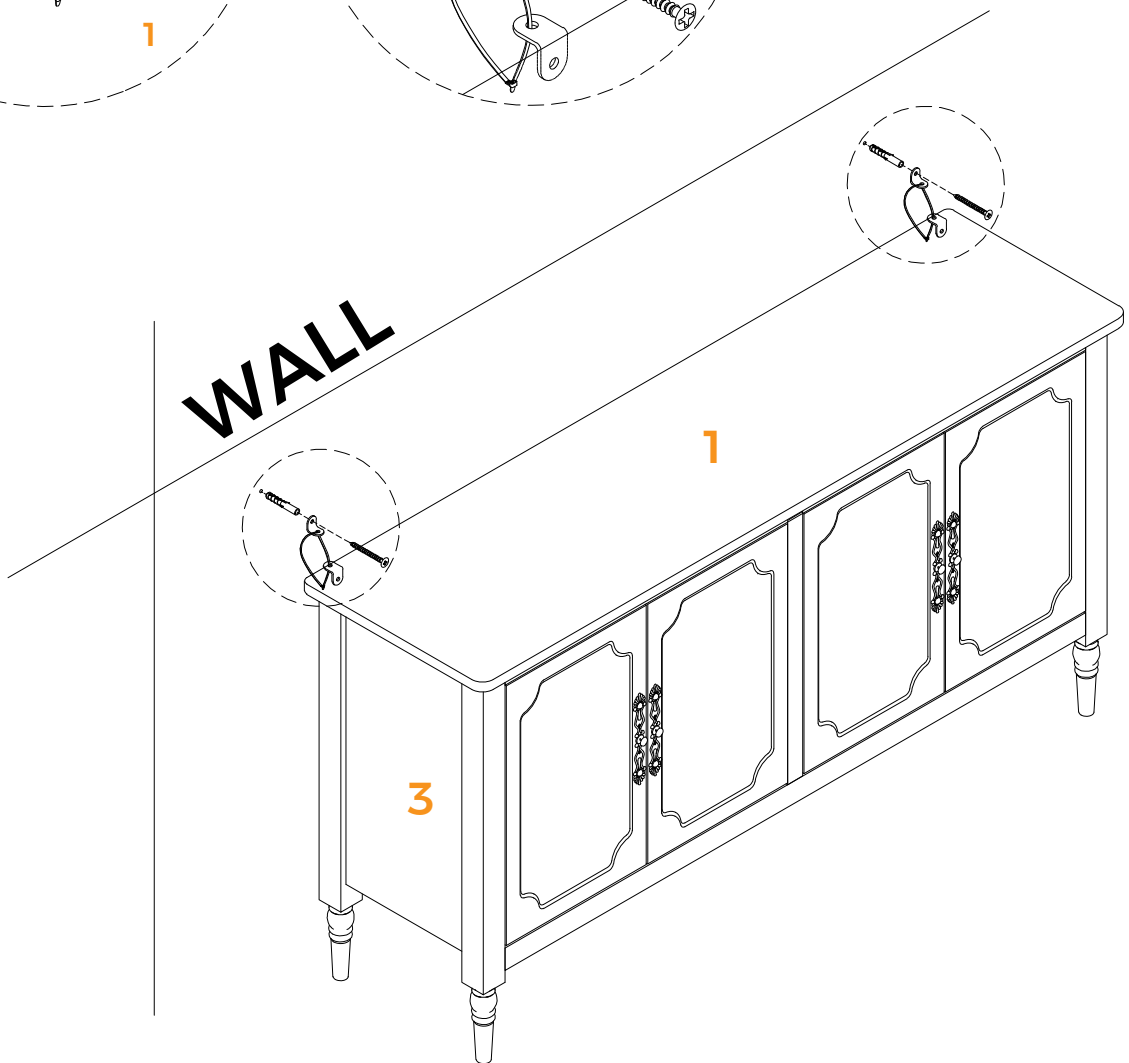
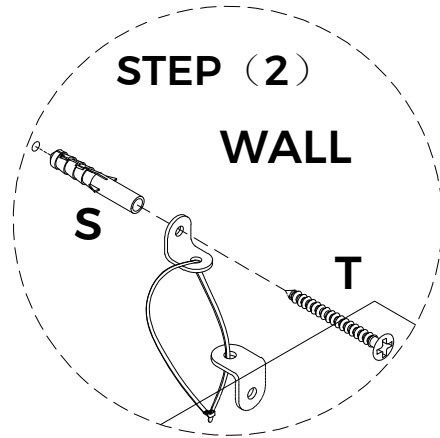
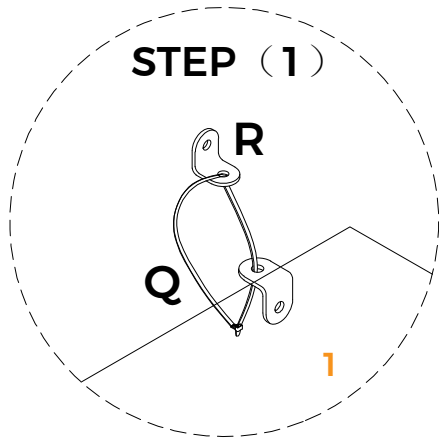
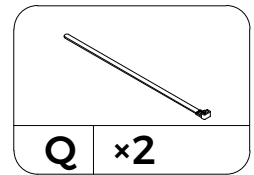
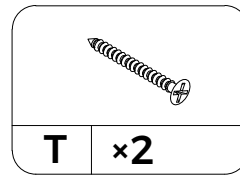
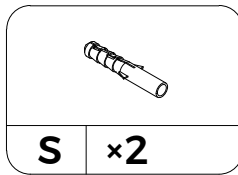
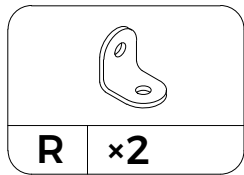



MAINTENANCE AND CARE

Prevent Moisture Damage:

Safeguard your laminate furniture by keeping it in a dry environment. Store the furniture away from damp areas and water sources.

Sunlight Shielding:

Shield your laminate furniture from direct sunlight to prevent color fading and surface deterioration. Consider using curtains or blinds for protection, especially if direct sunlight exposure is unavoidable.

Regular Care:

Maintain your laminate furniture's appearance by gently wiping surfaces with a damp cloth. Avoid using overly wet cloths or abrasive cleaning tools.

Avoid Scratches:

Protect the furniture surface from scratches by refraining from placing sharp or hard objects on it. When moving the furniture, be cautious not to scrape the legs against the floor.

Proper Weight Distribution:

Prevent structural damage by placing heavy objects on stable support surfaces rather than directly on the laminate furniture's surface. This simple step can prolong the life of your furniture.



Evite daños por humedad:

Proteja sus muebles laminados manteniéndolos en un ambiente seco. Guarde los muebles lejos de zonas húmedas y fuentes de agua.

Protéjalos de la luz solar:

Proteja sus muebles laminados de la luz solar directa para evitar la pérdida de color y el deterioro de la superficie. Considere el uso de cortinas o persianas como protección, especialmente si la exposición directa a la luz solar es inevitable.

Cuidado regular:

Mantenga el aspecto de sus muebles laminados limpiando suavemente las superficies con un paño húmedo. Evite utilizar paños demasiado húmedos o herramientas de limpieza abrasivas.

Evite los arañazos:

Proteja la superficie del mueble de arañazos evitando colocar objetos afilados o duros sobre ella. Al mover el mueble, tenga cuidado de no raspar las patas contra el suelo.

Distribución adecuada del peso:

Evite daños estructurales colocando objetos pesados sobre superficies de apoyo estables en lugar de directamente sobre la superficie del mueble laminado. Este sencillo paso puede prolongar la vida de sus muebles.



WARRANTY INFORMATION

Warranty Coverage: Our warranty provides protection against manufacturing defects in materials and workmanship for a specified period from the date of purchase, as outlined in the accompanying warranty documentation.

Exclusions: The warranty does not cover damages resulting from misuse, negligence, accidents, normal wear and tear, unauthorized repairs or modifications, improper assembly, or failure to adhere to the care and maintenance guidelines provided.

WARRANTY CLAIM PROCESS

To initiate a return on Amazon, please follow these steps:

1. Log into your Amazon account and go to the "Your Orders" section.
2. Locate the order containing the item you wish to return.
3. Contact our customer service for assistance in obtaining a prepaid return label.
4. Once you receive the return label, securely affix it to the package.
5. You can then choose to drop off the package at a designated carrier location or arrange for a pickup.
6. After we receive and inspect the returned product, we will initiate the refund process.
7. The refund will be credited back to the original payment method used during the purchase.
8. Typically, refunds are processed within 3-5 business days.

Cobertura de la garantía: Nuestra garantía proporciona protección contra defectos de fabricación en materiales y mano de obra durante un período determinado a partir de la fecha de compra, como se indica en la documentación de garantía adjunta.

Exclusiones: La garantía no cubre los daños resultantes de uso indebido, negligencia, accidentes, desgaste normal, reparaciones o modificaciones no autorizadas, montaje incorrecto o incumplimiento de las directrices de cuidado y mantenimiento proporcionadas. Las directrices de cuidado y mantenimiento proporcionadas.

PROCESO DE RECLAMACIÓN DE LA GARANTÍA

Para iniciar una devolución en Amazon, siga estos pasos:

1. Accede a tu cuenta de Amazon y ve a la sección "Tus pedidos".
2. Localiza el pedido que contiene el artículo que deseas devolver.
3. Ponte en contacto con nuestro servicio de atención al cliente para que te ayuden a obtener una etiqueta de devolución prepagada.
6. Después de que recibamos e inspeccionemos el producto devuelto, iniciaremos el proceso de reembolso.
7. El reembolso se abonará de nuevo al método de pago original utilizado durante la compra.
8. Normalmente, los reembolsos se procesan en un plazo de 3 a 5 días laborables.
4. Una vez que reciba la etiqueta de devolución, fíjela firmemente al paquete.
5. A continuación, puede optar por depositar el paquete en el lugar designado por el transportista o solicitar que lo recojan.

★ SHARE YOUR SPACE ★

We love to see where our furniture ends up-
snap a pic and tag if on Instagram or Face-
book for your chance to be featured on our
social channels and WIN A PRIZE



LEARN MORE

★ COMPARTE SU ESPACIO ★

Nos encanta ver dónde acaban sus muebles.
Tome una foto y etiquétela en Instagram o
Facebook para tener la oportunidad de apa-
recer en nuestros canales sociales y GANAR
UN PREMIO.

    @royalcrafthome



ROYALCRAFT



707-392-8405



support@royalcraft.store



www.royalcraft.store



[Royalcrafthome](#)

If you have any problems, please send your order number and photos to us .
We will contact you within 24 hours and provide you with a satisfactory solution.