

# Microwave Oven

## **INSTRUCTION MANUAL**

### **MODEL: EM053K6DM-P**

Read these instructions carefully before using your microwave oven, and keep it carefully.

If you follow the instructions, your oven will provide you with many years of good service.

**SAVE THESE INSTRUCTIONS CAREFULLY**

# PRECAUTIONS TO AVOID POSSIBLE EXPOSURE TO EXCESSIVE MICROWAVE ENERGY

- (a) Do not attempt to operate this oven with the door open since open door operation can result in harmful exposure to microwave energy.  
It is important not to defeat or tamper with the safety interlocks.
- (b) Do not place any object between the oven front face and the door or allows soil or cleaner residue to accumulate on sealing surfaces.
- (c) Do not operate the oven if it is damaged. It is particularly important that the oven door close properly and that there is no damage to the:
  - (1) DOOR (bent)
  - (2) HINGES AND LATCHES (broken or loosened)
  - (3) DOOR SEALS AND SEALING SURFACES
- (d) The oven should not be adjusted or repaired by anyone except properly qualified service personnel.

## Specifications

Model	EM053K6DM-P
Rated Voltage	120 V~ 60 Hz
Microwave Input	1500 W
Microwave Output	1000 W

# IMPORTANT SAFETY INSTRUCTIONS

When using electrical appliances basic safety precautions should be followed, including the following:

**WARNING** - To reduce the risk of burns, electric shock, fire, injury to persons or exposure to excessive microwave energy:

1. Read all instructions before using the appliance.
2. Read and follow the specific: "PRECAUTIONS TO AVOID POSSIBLE EXPOSURE TO EXCESSIVE MICROWAVE ENERGY" found on page 2.
3. This appliance must be grounded. Connect only to properly grounded outlet. See "GROUNDING INSTRUCTIONS" found on page 4.
4. Install or locate this appliance only in accordance with the provided installation instructions.
5. Some products such as whole eggs and sealed containers - for example, closed glass jars - are able to explode and should not be heated in this oven.
6. Use this appliance only for its intended use as described in the manual. Do not use corrosive chemicals or vapors in this appliance. This type of oven is specifically designed to heat, cook or dry food. It is not designed for industrial or laboratory use.
7. As with any appliance, close supervision is necessary when used by children.
8. Do not operate this appliance if it has a damaged cord or plug, if it is not working properly, or if it has been damaged or dropped.
9. This appliance should be serviced only by qualified service personnel. Contact nearest authorized service facility for examination, repair, or adjustment.
10. Do not cover or block any openings on the appliance.
11. Do not store this appliance outdoors. Do not use this product near water - for example, near a kitchen sink, in a wet basement, near a swimming pool, or similar location.
12. Do not immerse cord or plug in water.
13. Keep cord away from heated surface.
14. Do not let cord hang over edge of table or counter.
15. When cleaning surfaces of door and oven that comes together on closing the door, use only mild, nonabrasive soaps, or detergent applied with a sponge or soft cloth.
16. To reduce the risk of fire in the oven cavity:
  - 1). Do not overcook food. Carefully attend appliance when paper, plastic, or other combustible materials are placed inside the oven to facilitate cooking.
  - 2). Remove wire twist-ties from paper or plastic bag before placing bag in oven.
  - 3). If material inside of the oven ignite, keep oven door closed, turn oven off, and disconnect the power cord, or shut off power at the fuse or circuit breaker panel.
  - 4). Do not use the cavity for storage purposes. Do not leave paper products, cooking utensils, or food in the cavity when not in use.
17. Liquids, such as water, coffee, or tea are able to be overheated beyond the boiling point without appearing to be boiling. Visible bubbling or boiling when the container is removed from the microwave oven is not always present.

THIS COULD RESULT IN VERY HOT LIQUID SUDDENLY BOILING OVER WHEN THE CONTAINER IS DISTURBED OR A UTENSIL IS INSERTED INTO THE LIQUID.

To reduce the risk of injury to persons:

- 1) Do not overheat the liquid.
- 2) Stir the liquid both before and halfway through heating it.
- 3) Do not use straight-sided containers with narrow necks.
- 4) After heating, allow the container to stand in the microwave oven for a short time before removing the container.
- 5) Use extreme care when inserting a spoon or other utensil into the container.
18. Do not operate any heating or cooking appliance beneath the appliance.  
(Exception: A microwave oven investigated for use above another heating appliance.)
19. Do not mount unit over or near any portion of heating or cooking appliance.  
(Exception: A microwave oven investigated for use above another heating appliance.)
20. Do not mount over sink.
21. Do not store anything directly on top of the appliance surface when the appliance is in operation.
22. Clean Ventilation Hoods Frequently - Grease should not be allowed to accumulate on hood or filter.
23. When flaming foods under the hood, turn the fan on.
24. Use care when cleaning the vent-hood filter. Corrosive cleaning agents, such as lye-based oven cleaners, may damage the filter.
25. Suitable for use above both gas and electric cooking equipment.

## SAVE THESE INSTRUCTIONS

## GROUNDING INSTRUCTIONS

This appliance must be grounded. In the event of an electrical short circuit, grounding reduces the risk of electric shock by providing an escape wire for the electric current. This appliance is equipped with a cord having a grounding wire with a grounding plug. The plug must be plugged into an outlet that is properly installed and grounded.

**WARNING** - Improper use of the grounding can result in a risk of electric shock.

Consult a qualified electrician or serviceman if the grounding instructions are not completely understood, or if doubt exists as to whether the appliance is properly grounded. If it is necessary to use an extension cord, use only a 3-wire extension cord that has a 3-blade grounded plug, and 3-slot receptacle that will accept the plug on the appliance. The marked rating of the extension cord shall be equal to or greater than the electrical rating of the appliance.

**DANGER** - Electric Shock Hazard

Touching some of the internal components can cause serious personal injury or death. Do not disassemble this appliance.

**WARNING** - Electric Shock Hazard

Improper use of the grounding can result in electric shock. Do not plug into an outlet until appliance is properly installed and grounded.

1. A short power-supply cord is provided to reduce the risks resulting from becoming entangled in or tripping over a longer cord.
2. Longer cord sets or extension cords are available and may be used if care is exercised in their use.
3. If a long cord or extension cord is used:
  - 1) The marked electrical rating of the cord set or extension cord should be at least as great as the electrical rating of the appliance.
  - 2) The extension cord must be a grounding-type 3-wire cord.
  - 3) The longer cord should be arranged so that it will not drape over the counter top or tabletop where it can be pulled on by children or tripped over unintentionally.

## RADIO INTERFERENCE

1. Operation of the microwave oven may cause interference to your radio, TV or similar equipment.
2. When there is interference, it may be reduced or eliminated by taking the following measures:
  - 1) Clean door and sealing surface of the oven
  - 2) Reorient the receiving antenna of radio or television.
  - 3) Relocate the microwave oven with respect to the receiver.
  - 4) Move the microwave oven away from the receiver.
  - 5) Plug the microwave oven into a different outlet so that microwave oven and receiver are on different branch circuits.

**This device complies with part 18 of the FCC Rules.**

# UTENSILS

## CAUTION - Personal Injury Hazard

Tightly-closed utensils could explode. Closed containers should be opened and plastic pouches should be pierced before cooking.

See the instructions on "Materials you can use in microwave oven or to be avoided in microwave oven."

There may be certain non-metallic utensils that are not safe to use for microwaving. If in doubt, you can test the utensil in question following the procedure below.

### Utensil Test:

1. Fill a microwave-safe container with 1 cup of cold water (250ml) along with the utensil in question.
2. Cook on maximum power for 1 minute.
3. Carefully feel the utensil. If the empty utensil is warm, do not use it for microwave cooking.
4. Do not exceed 1 minute cooking time.

## Materials you can use in microwave oven

Utensils	Remarks
Browning dish	Follow manufacturer* instructions. The bottom of browning dish must be at least 3/16 inch (5mm) above the turntable. Incorrect usage may cause the turntable to break.
Dinnerware	Microwave-safe only. Follow manufacturer's instructions. Do not use cracked or chipped dishes.
Glass jars	Always remove lid. Use only to heat food until just warm. Most glass jars are not heat resistant and may break.
Glassware	Heat-resistant oven glassware only. Make sure there is no metallic trim. Do not use cracked or chipped dishes.
Oven cooking bags	Follow manufacturer* instructions. Do not close with metal tie. Make slits to allow steam to escape.
Paper plates and cups	Use for short term cooking/warming only. Do not leave oven unattended while cooking.
Paper towels	Use to cover food for reheating and absorbing fat. Use with supervision for a short-term cooking only.
Parchment paper	Use as a cover to prevent splattering or a wrap for steaming.

## Materials you can use in microwave oven

Utensils	Remarks
Plastic	Microwave-safe only. Follow the manufacturer* instructions. Should be labeled "Microwave Safe". Some plastic containers soften, as the food inside gets hot. "Boiling bags" and tightly closed plastic bags should be slit, pierced or vented as directed by package.
Plastic wrap	Microwave-safe only. Use to cover food during cooking to retain moisture. Do not allow plastic wrap to touch food.
Thermometers	Microwave-safe only (meat and candy thermometers).
Wax paper	Use as a cover to prevent splattering and retain moisture.

## Materials to be avoided in microwave oven

Utensils	Remarks
Aluminum tray	May cause arcing. Transfer food into microwave-safe dish.
Food carton with metal handle	May cause arcing. Transfer food into microwave-safe dish.
Metal or metal-trimmed utensils	Metal shields the food from microwave energy. Metal trim may cause arcing.
Metal twist ties	May cause arcing and could cause a fire in the oven.
Paper bags	May cause a fire in the oven.
Plastic foam	Plastic foam may melt or contaminate the liquid inside when exposed to high temperature.
Wood	Wood will dry out when used in the microwave oven and may split or crack.

# NAMES OF OVEN PARTS AND ACCESSORIES

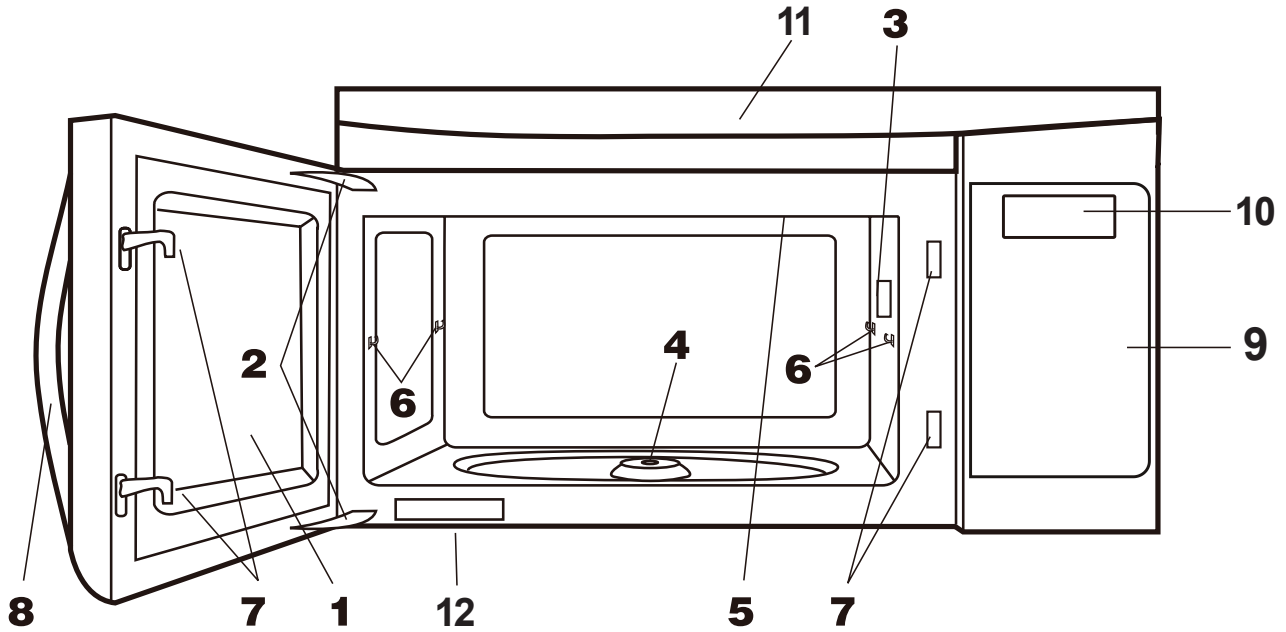

- 1 Microwave oven door with see-through window
- 2 Door hinges
- 3 Waveguide cover:  
DO NOT REMOVE.
- 4 Turntable motor shaft
- 5 Microwave oven light  
It will light when microwave oven is operating or door is open.
- 6 Rack holders
- 7 Safety door latches  
The microwave oven will not operate unless the door is securely closed.

- 8 Handle
- 9 control panel
- 10 Display screen
- 11 Ventilation openings
- 12 Rating label

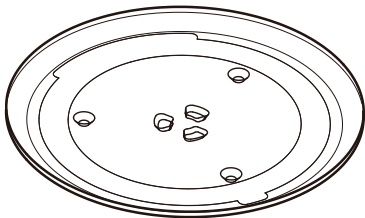

Glass turntable

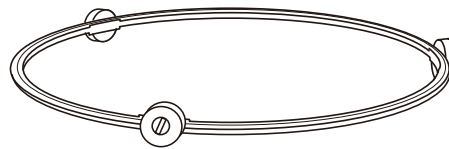

Turntable Ring Assembly



# OPERATION

- Before operating your new oven make sure you read and understand this Use and Care Guide completely.
- The clock can be disabled when the microwave is first plugged in and the STOP key is selected.  
To re-enable the clock follow clock instructions.

## SETTING THE CLOCK

- Suppose you want to enter the correct time of day 10:59

Touch:	Display Shows:
1. Clock	10:00 (Current time)
2. (1) (0) (5) (9)	10:59 <small>PRESS START</small>
3. Clock or Start+30sec.	10:59

## SETTING THE TIMER

Your microwave oven can be used as a kitchen timer. You can set up to 99 minutes, 99 seconds. The kitchen timer can be used while the microwave oven is running.

- Suppose you want to set for three minutes.

Touch:	Display Shows:
1. Timer	TIMER : 0
2. (3) (0) (0)	TIMER 3:00
3. Timer	TIMER 3:00 (Time counting down)

### NOTE

There are not any other programs during the kitchen timer

## MICROWAVE

Your Over the Range Microwave Oven can be programmed for 99 minutes 99 seconds (99 :99). Always enter the seconds after the minutes, even if they are both zeros.

- Suppose you want to cook for 2 minutes at 90% power

Touch:	Display Shows:
1. Cook Time	: 0
2. (2) (0) (0)	2:00 <small>PRESS START</small>
3. Power Level X1	P-HI <small>PRESS START</small>
4. Power Level X1 or (9)	P-90 <small>PRESS START</small>
5. Start+30sec.	COOK 2:00

## POWER CHART

PRESS	POWER LEVEL	DISPLAY
POWER LEVEL x 1	100%	P-HI
POWER LEVEL x 2 or 9	90%	P-90
POWER LEVEL x 3 or 8	80%	P-80
POWER LEVEL x 4 or 7	70%	P-70
POWER LEVEL x 5 or 6	60%	P-60
POWER LEVEL x 6 or 5	50%	P-50
POWER LEVEL x 7 or 4	40%	P-40
POWER LEVEL x 8 or 3	30%	P-30
POWER LEVEL x 9 or 2	20%	P-20
POWER LEVEL x 10 or 1	10%	P-10
POWER LEVEL x 11 or 0	0%	P-0

# OPERATION

## WEIGHT DEFROST

Touch:	Display Shows:
1. DefrostX1	<small>SEE MENU LABEL</small> 0.0
2. (1) (2)	<small>PRESS START</small> 1.2 <small>lb</small>
3. Start+30sec.	Time counting down

## TIME DEFROST

Touch:	Display Shows:
1. DefrostX2	<small>SEE MENU LABEL</small> 0:00
2. (1) (2) (0) (0)	<small>PRESS START</small> 12:00
3. Start+30sec.	<small>COOK DEFR</small> 12:00 (Time counting down)

### NOTE

The buzzer will sound to remind you of turning over the food when half of the time has passed on.

## SPEED COOKING

### Using Add 30 Sec.

This is a time-saving pad. It is a simplified feature that lets you quickly set and start microwave cooking at 100% power.

Touch:	Display Shows:
1. Start+30sec.	<small>COOK</small> :30

### Using Number Pads For "1-6"

Press number pads "1-6" to start cooking with corresponding time for 100% power level directly.

For example, cooking with 3 minutes for 100% power level.

Touch:	Display Shows:
1. (3)	<small>PRESS START</small> : 3
2. After 2 seconds	<small>COOK</small> 3:00

The oven should be opened and closed in 5 minutes before the speed cooking, otherwise, operating as below.

Touch:	Display Shows:
1. (2)	Food
2. open the door	<small>PRESS START</small> 2:00
3. START Enter/+30Sec	Time counting down (Close the door)

### NOTE

"Food" will be displayed if a quick start cooking cycle or +30 sec key is not selected within 5 minutes of placing food in the microwave. You must open then close the door again to clear "Food" from the display.

# OPERATION

## VEGGIES

Touch:	Display Shows:
1. VeggiesX1	<small>SEE MENU LABEL</small> Fr-1
VeggiesX2	<small>SEE MENU LABEL</small> Fr-2
2. ①	<small>PRESS START</small> 1CUP
3. Start+30sec.	Time counting down

## POPCORN

Press "Popcorn" key and LED displays 3.3 oz. Press "Popcorn" repeatedly to choose the desired weight.

- Suppose you want to cook 3.0 oz. popcorn.

Touch:	Display Shows:
1. Popcorn	<small>SEE MENU LABEL PRESS START</small> 3.3 oz
2. PopcornX1	<small>SEE MENU LABEL PRESS START</small> 3.0 oz
3. Start+30sec.	Time counting down

Press popcorn pad	Amount
X1	3.3 oz
X2	3.0 oz
X3	1.75 oz

## POTATO

Touch:	Display Shows:
1. Potato	<small>SEE MENU LABEL PRESS START</small> 1
2. PotatoX1 or ②	<small>SEE MENU LABEL PRESS START</small> 2
3. Start+30sec.	Time counting down

Press potato pad or number keys	Amount
X1	1
X2	2
X3	3
X4	4

# OPERATION

## SNACK MENUS

There are 4 options ( Hot dogs,Frozen Kids Meal Meal In A Cup,Soup)under the snack menu.

- (Hot dogs,Soup)

---

Touch: Display Shows:

---

1. Snack MenusX1 SEE MENU LABEL  
5n-1
2. (1) PRESS START  
|
3. Start+30sec. Time counting down

Press snack menu pad	Food	Amount
X1	Hot Dogs	1-6 pieces
X2	Frozen Kids Meal	8.8 Oz
X3	Meal in a cup	2.39 Oz
X4	Soup	1-2 cups

- (Frozen Kids Meal,Meal In A Cup)

---

Touch: Display Shows:

---

1. Snack MenusX2 SEE MENU LABEL  
5n-2
2. Start+30sec. Time counting down

## AUTO COOK

There are 5 options(Bacon,Dinner Plate,Rice,Frozen breakfast,Frozen Pizza)under the auto cook.

---

Touch: Display Shows:

---

1. Auto cookX1 SEE MENU LABEL  
Ac-1
2. (2) PRESS START  
2
3. Start+30sec. Time counting down

Press auto cook	Food	Amount
X1	Bacon	1-3 Slices
X2	Dinner Plate	1-2 Plates
X3	Rice	1-2 Cups
X4	Frozen breakfast	8/12 Oz
X5	Frozen Pizza	6/8/12 Oz

# OPERATION

## MELT/SOFTEN

The oven uses low power to melt and soften items. See the following table.

- Suppose you want to melt 2 sticks of Butter.

Touch:	Display Shows:
1. Melt/ Soften X1	<small>SEE MENU LABEL</small> 50-1
2. (2)	<small>PRESS START</small> 2
3. Start+30sec.	Time counting down

Press Melt Soften pad	Food	Amount
X1	Melt Butter	1/2 stick
X2	Melt Chocolate	2/4/8 oz
X3	Soften Ice Cream	Pint/1.5Quart
X4	Soften Cream Cheese	3/8 oz

## CHILD LOCK

Touch:	Display Shows:
1. STOP/CANCEL (for 3 seconds)	<small>LOCK</small> or <small>LOCK</small> 11:00 (if clock is set)
2. STOP/CANCEL (for 3 seconds)	11:00 (if clock is set)

## STAGE COOK

At most two stages of microwave can be set. Defrost can't be one of the multi-stage.



Touch:	Display Shows:
1. (1) (2) (0)	<small>PRESS START</small> 1:20
2. Power Level	<small>PRESS START</small> P-H1
3. Power Level X8 or (2)	<small>PRESS START</small> P-20
4. Cook Time	: 0
5. (1) (0) (5) (9)	<small>PRESS START</small> 10:59
6. Power Level	<small>PRESS START</small> P-H1
7. Power Level X7 or (3)	<small>PRESS START</small> P-30
8. Start+30sec.	Time counting down

# OPERATION

## VENT FAN

The pad controls the 2-speed vent fan. If the vent fan is OFF, the first touch of the Vent pad will turn the fan on HIGH, second touch LOW and third touch OFF.



- Suppose you want to set the vent fan speed to LOW from the OFF position.

Touch:	Display Shows:
1.  x1	Hi
2.  x2	Lo
3.  x3	OFF

## LIGHT

The pad controls the 2-states light. If the light is OFF the first touch of the light pad will turn the light on ON, second touch OFF

- Suppose you want to set the light for ON from the OFF position.

Touch:	Display Shows:
1.  x1	ON
2.  x2	OFF

## USER PREF

Key	Setting
USER PREFx1	Weight lb/kg
USER PREFx2	Demo Mode

## WEIGHT (LBS / KG)

In waiting state

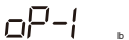
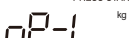
Touch:	Display Shows:
1. USER PREFx1	<small>SEE MENU LABEL</small> <small>PRESS START</small> 
2. Start+30sec.	<small>PRESS START</small>  or <small>PRESS START</small> 
3. Start+30sec.	Time counting down

# OPERATION

## DEMO SETTING

In waiting state

---

Touch: Display Shows:

---

1.USER PREFx2

SEE MENU LABEL PRESS START

2.Start+30sec.

PRESS START  
  
 or  
PRESS START

3.Start+30sec.

Time counting down

## VOLUME SETTING

In waiting state

---

Touch: Display Shows:

---

1.ECO

(for 3 seconds)

2.ECO

(for 3 seconds)

## DISPLAY SETTING

In waiting state

Key	Darkness of display
ECO x1	Dim
ECO x2	Off

# MAINTENANCE

## Troubleshooting

Check your problem by using the chart below and try the solutions for each problem. If the microwave oven still does not work properly, contact the nearest authorized service center.

TROUBLE	POSSIBLE CAUSE	POSSIBLE REMEDY
Oven will not start	<ul style="list-style-type: none"> <li>a. Electrical cord for oven is not plugged in.</li> <li>b. Door is open.</li> <li>c. Wrong operation is set.</li> </ul>	<ul style="list-style-type: none"> <li>a. Plug into the outlet.</li> <li>b. Close the door and try again.</li> <li>c. Check instructions.</li> </ul>
Arcing or sparking	<ul style="list-style-type: none"> <li>a. Materials to be avoided in microwave oven were used.</li> <li>b. The oven is operated when empty.</li> <li>c. Spilled food remains in the cavity.</li> </ul>	<ul style="list-style-type: none"> <li>a. Use microwave-safe cookware only.</li> <li>b. Do not operate with oven empty.</li> <li>c. Clean cavity with wet towel.</li> </ul>
Unevenly cooked foods	<ul style="list-style-type: none"> <li>a. Materials to be avoided in microwave oven were used.</li> <li>b. Food is not defrosted completely.</li> <li>c. Cooking time, power level is not suitable.</li> <li>d. Food is not turned or stirred.</li> </ul>	<ul style="list-style-type: none"> <li>a. Use microwave-safe cookware only.</li> <li>b. Completely defrost food.</li> <li>c. Use correct cooking time, power level.</li> <li>d. Turn or stir food.</li> </ul>
Overcooked foods	Cooking time, power level is not suitable.	Use correct cooking time, power level.
Undercooked foods	<ul style="list-style-type: none"> <li>a. Materials to be avoided in microwave oven were used.</li> <li>b. Food is not defrosted completely.</li> <li>c. Oven ventilation ports are restricted.</li> <li>d. Cooking time, power level is not suitable.</li> </ul>	<ul style="list-style-type: none"> <li>a. Use microwave-safe cookware only.</li> <li>b. Completely defrost food.</li> <li>c. Check to see that oven ventilation ports are not restricted.</li> <li>d. Use correct cooking time, power level.</li> </ul>
Improper defrosting	<ul style="list-style-type: none"> <li>a. Materials to be avoided in microwave oven were used.</li> <li>b. Cooking time, power level is not suitable.</li> <li>c. Food is not turned or stirred.</li> </ul>	<ul style="list-style-type: none"> <li>a. Use microwave-safe cookware only.</li> <li>b. Use correct cooking time, power level.</li> <li>c. Turn or stir food.</li> </ul>