



BV9351B USER'S MANUAL

BLUETOOTH® | DVD/MP3/CD AM/FM RECEIVER
FEATURING 6.2" (157 mm) WIDESCREEN TOUCHSCREEN
DIGITAL TFT LED MONITOR

BOSS Audio Systems
3451 Lunar Court • Oxnard, CA 93030
www.bosssaudio.com
805-751-4853 Customer Service
Tech Support: www.bosssaudio.com/support



1019

**To ensure safety while driving
and to comply with laws,
drivers should not watch video or
operate the video device while driving.**

Congratulations on your purchase of a **Boss Audio Systems**®
Multimedia Receiver.

It has been designed, engineered and manufactured to bring you
the highest level of performance and quality, and will offer you
years of entertainment pleasure.

CONTENTS

Specifications.....	1
Safety Notice.....	2
Accessories.....	3
Unit Installation.....	3
Remote Control Operation.....	4
Wires Connection Description.....	5
Panel Introduction.....	6
Main Menu Operation Instruction.....	7
Access Setup Interface.....	8
General Settings.....	7
Camera Settings.....	8
Clock Settings.....	8
Audio Settings.....	8
Tuner Settings.....	9
Illumination Settings.....	9
About Settings.....	10
Tuner Operation.....	10
DISC/CD/USB/SD Playback.....	11
DVD Mode operation.....	11
Media Playing— CD Audio.....	12
CD Source Menu	12
USB/SD Music/Video/Picture.....	12
Bluetooth Operation.....	13
Bluetooth Operation Menu.....	13
Bluetooth Keypad.....	13
Bluetooth Call.....	13
Bluetooth Phonebook.....	14
Bluetooth Phone Call History.....	14
Bluetooth Music Steaming-A2DP.....	14
Bluetooth Pair device.....	14
Photos.....	15
Camera/Aux/AV Menu.....	15
Troubleshooting.....	16

SPECIFICATIONS

Model No.	BV9351B		
General features	Fixed front panel 6.2 inch TFT screen FM/AM Radio RBDS DVD fully compatible with DVD/VCD/CD/MP3/MPEG4/JPEG Front USB&SD reader support Built-in Bluetooth AUX Input AV Input AV output Front/Rear view camera Front,Rear and Subwoofer Pre-Amp.Output 4*80W AMP power output maximum Steering wheel control		
TFT screen	800*480pixel		
SD	32G		
Working power	12V		
Max Output	4*80W		
Working Temperature	-20°C~70°C/-4°F~158°F		
Installation Size	6.77"*3.82"*6.29" (172.2*97.2*160mm)		
Weight	1.58kg/3.48lbs		
Compatible Media			
Picture	JPG/JPEG/BMP		
Disc	CD/CD-R/CD-RW/DVD/DVD±R/DVD±RW		
Audio file	MP3/WAV		
Video file	Format	Video code	Audio code
	.MPEG1	MPEG1	MP2
	.MPG	MPEG2	MP2

SAFETY NOTICE

Please read and understand the following safety information before operating this unit.

- ⊘ The device is suitable for 12V power supply (requires grounding). Do not connect it to 24V power supply in trucks or buses, or else it will be damaged.
- ❗ Please use genuine discs instead of incompatible discs, or it will damage the device and/or shorten the service life.
- ❗ Without the guide of qualified personnel, do not replace the fuse, or else it may damage the device or cause fire.
- ⚠ Please follow the traffic laws and regulations and do not watch programs or operate the device when you are driving, to avoid accidents(excluding passengers watching through rear monitor).
- ❗ To ensure safety and operate the device normally, please ask qualified personnel to install the device. Do not disassemble or repair the device without authorization, to avoid damage and accidents. please contact a local car audio distributor for details.
- ⊘ Do not put the device in a moist environment or water, to avoid electric shock, damage and/or fire due to a short circuit.
- ⊘ The mechanical drive part of the monitor uses an automatic precision transmission component. Do not pull, push or rotate the device by force or impact the TFT screen to avoid damaging the device.
- ❗ Do not insert the audio plug of the vehicle into the master unit directly. Please convert with the dedicated end cable provided by our company.
- ❗ When installing the unit, prevent metal objects from falling into the master unit from the vents to avoid a short circuit and damaging the device.

Safety Statement

- ⊘ For the safety of yourself and others, do not watch programs or operate the device when you are driving. It is prohibited by law.
- ❗ The back up monitor function should be used as an auxiliary view only. We are not responsible for any accidents occurred during backing.

ACCESSORIES

Remote.....	1
Power Cable.....	1
Mounting Brackets.....	2
Screw.....	8
Trim Ring.....	1

UNIT INSTALLATION

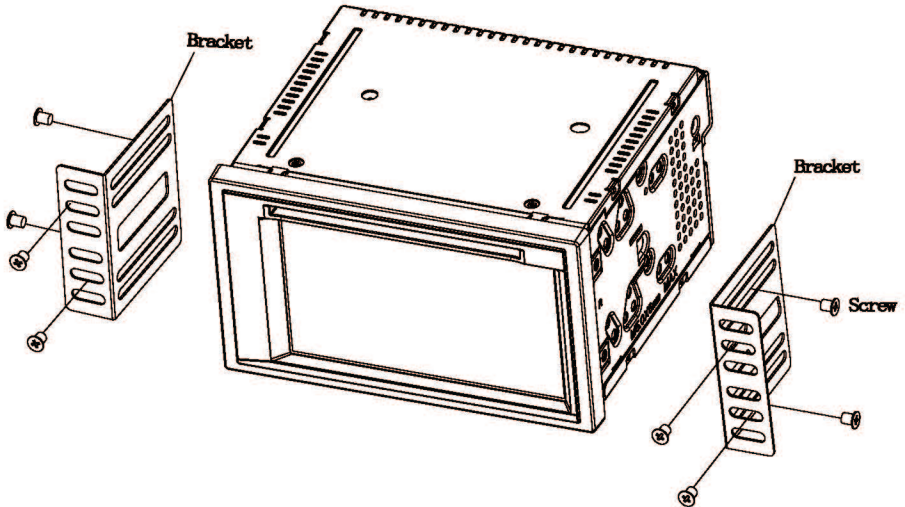

1. Put the 2 brackets to the left and right side of the unit;
2. Use screws to fix the brackets to the unit.
3. Once the screws are attached, the brackets can be adjusted forward or backward depending on the installation requirements.

REMOTE CONTROL OPERATION

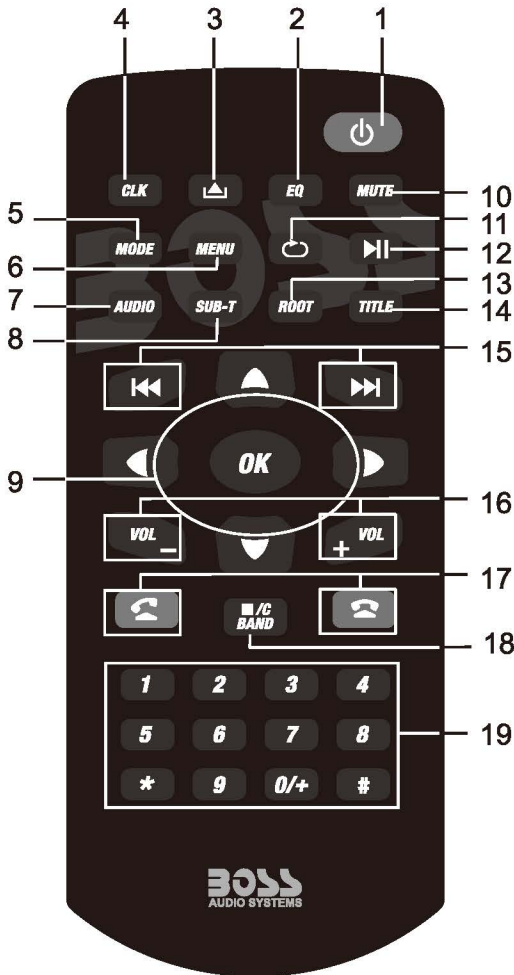

- 1.TURN ON/OFF
- 2.EQ mode
- 3.EJECT Key
- 4.CLK Key
- 5.MODE Key
- 6.MENU Key
- 7.Audio KEY
- 8.SUBTITLE Changing Key
- 9.Direction and OK Key
- 10.MUTE Key
- 11.REPEAT Key

- 12.Play/Pause
- 13.ROOT Key
- 14.TITLE Key
- 15.Under Disc/music/video mode,press to choose previous/next song.
- 16.VOLUME UP/DOWN Key
- 17.Receiving calls/call out; hang up.
- 18.STOP/C/BAND
- 19.Number Key

WIRES CONNECTION DESCRIPTION

The Description of the Input/Output Interface

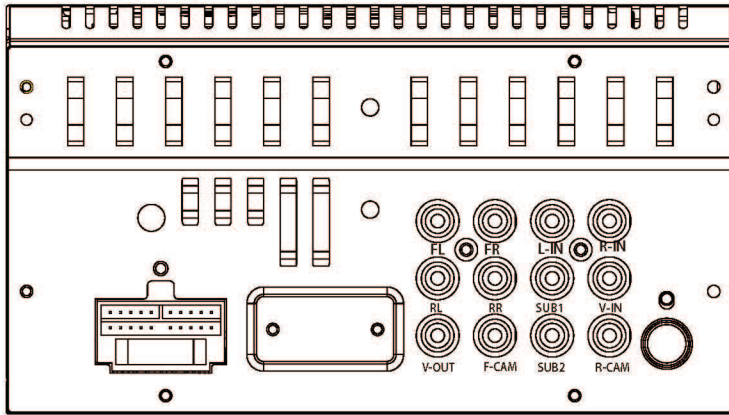

Main Harness

Pre-Amp
Output

AM/FM
Antenna

Power

Yellow.....	Constant (+12v)
Red.....	Accessory (+12v)
Black.....	Ground (-)
Orange.....	Illumination Input (+12v)
Violet/Wht.....	Reverse Input (+12v)
Blue.....	Ant. Output (+12v, 500 mA)
Blue/Wht.....	Rem. Output (+12v, 500 mA)
Lt.Green.....	Parking Brake Input

Control

3.5mm.....	SWC Input
------------	-----------

Speaker Outputs

White.....	Left Front (+)
White/Blk.....	Left Front (-)
Gray.....	Right Front (+)
Gray/Blk.....	Right Front (-)
Green.....	Left Rear (+)
Green/Blk.....	Left Rear (-)
Purple.....	Right Rear (+)
Purple/Blk.....	Right Rear (-)

Camera Power

Red/Violet.....	Front Output (+12v, 500 mA)
Red/White.....	Rear Output (+12v, 500 mA)

PANEL INTRODUCTION

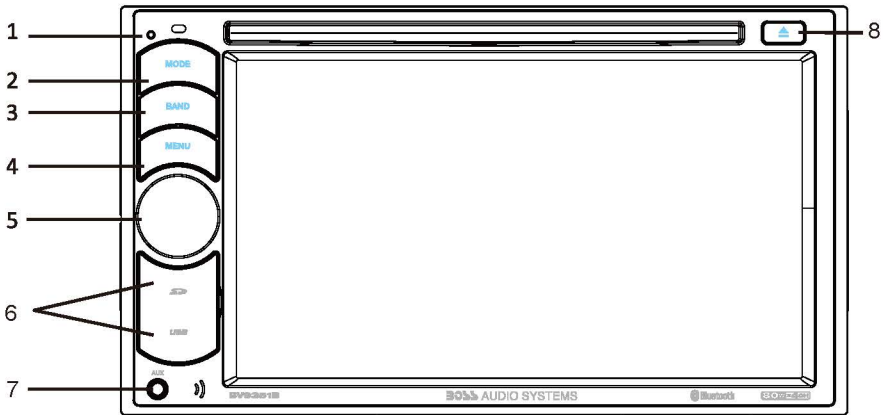

1.RESET key

2.MODE key

Press to select system mode.

3.BAND key

For radio band conversion between FM1/FM2/FM3/AM1/AM2.

4.MENU key

Press to return to the home menu, or previous source.

5.TURN ON/OFF&VOLUME UP/DOWN

Long touch to turn ON/OFF the unit. Short touch to activate the MUTE function and silence the audio output. Touch again to restore sound.

Rotate to adjust the output volume UP or DOWN.

5.Open to see SD slot,USB port.

7.AUX IN jack

8.Eject key

Press EJECT to remove the Disc

MAIN MENU OPERATION INSTRUCTION

MAIN MENU 1

- 1.Tuner Interface
- 2.Streaming Interface
- 3.DISC Interface
- 4.Phone Interface
- 5.USB Interface
- 6.SD Interface
- 7.Front/Rear Camera Interface
- 8.AV INPUT Interface

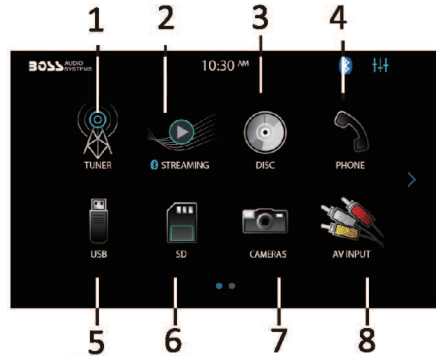

MAIN MENU 2

- 9.AUX IN Interface
- 10.Setting Interface

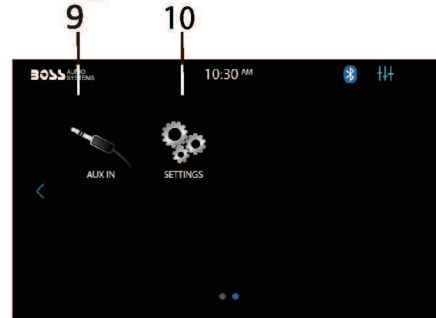

There are seven Setting Menus

GENERAL SETTINGS-Menu 1

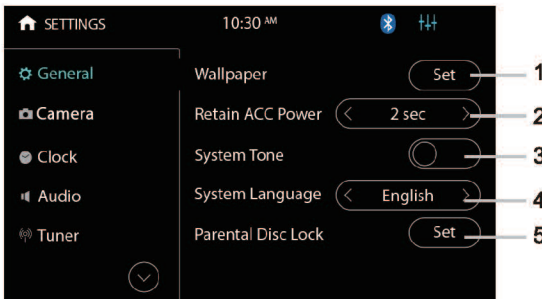

1. Touch to set wallpaper
2. Retain ACC Power: Select how many seconds to delay shut down after the vehicle powers down
3. When turned on, an audible beep tone confirms each function selection.
4. Touch System Language to select Spanish/English
5. Touch to select parental control level

ACCESS SETUP INTERFACE

CAMERA SETTINGS-Menu 2

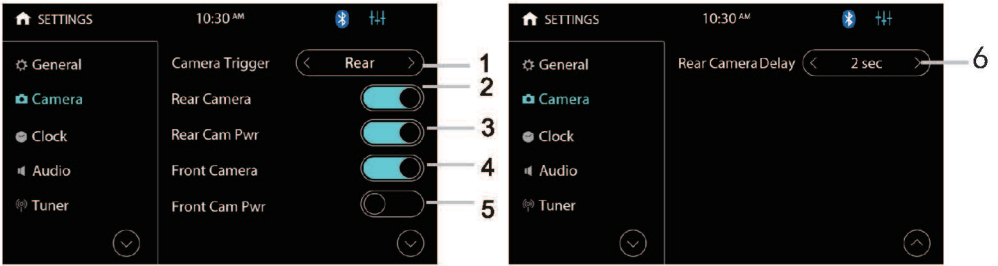

- 1.Camera Trigger:Touch to select Front/Rear/Off, select to display Front Camera, Rear Camera, or no response when reversing.
- 2.Rear Camera: Touch to turn on or turn off the Rear Camera function on main UI.
- 3.Rear Cam Pwr: Turn on to power Rear Camera.
- 4.Front Camera: Touch to turn on or turn off the Front Camera function on main UI.
- 5.Front Cam Pwr: Turn on to power Front Camera.
- 6.Select the delay setting to define the refresh rate for the Rear Camera image when the vehicle is in reverse gear. Options are off / 1 Sec / 2 Sec / 3 Sec. It can switch to front camera delay or Front Camera delay follow the Camera Trigger change .

CLOCK SETTINGS-Menu 3

- a. Press to set clock mode: 12/24 hr
- b. Press to set hour
- c. Press to set minute
- d. Press to set AM/PM at 12hr mode

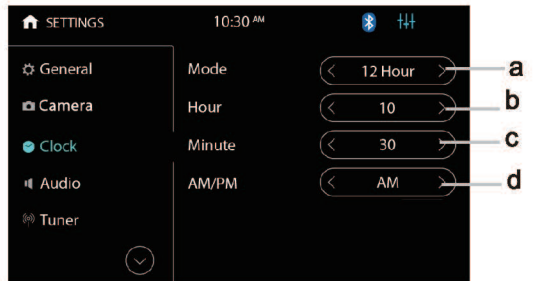

AUDIO SETTINGS-Menu 4

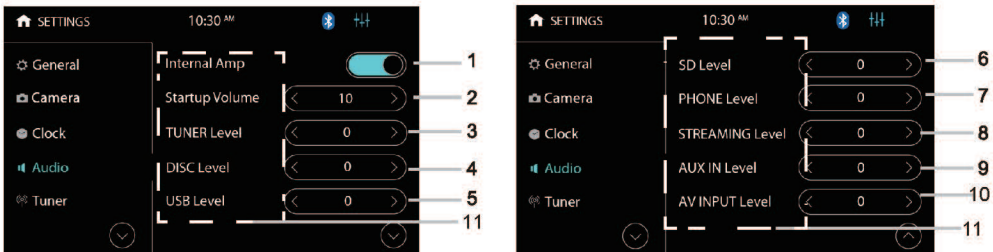

ACCESS SETUP INTERFACE

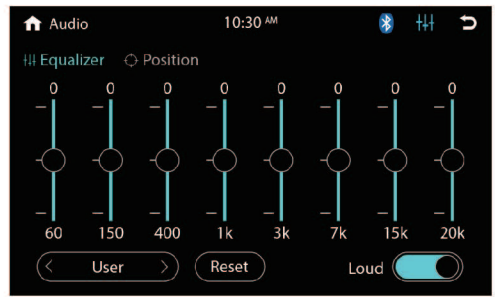
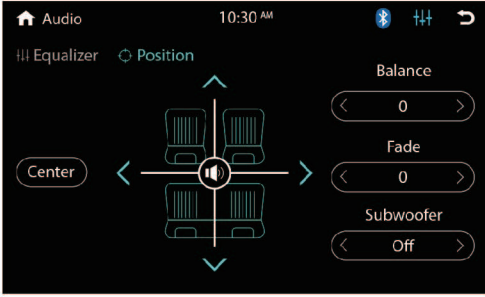

1. Touch to select whether to output sound from an external amplifier
2. Startup volume: default volume ;
 - ①.If the volume at the last shutdown is less than this volume, the volume at the last shutdown will be used when rebooting;
 - ②.if the volume at the last shutdown is greater than this volume, this default volume will be used when rebooting
- 3-10. Press to set preset gain.
11. Slide up or down to enter previous functions.

TUNER SETTINGS –Menu 5

1. Touch to choose between America/ EU regions.
2. Perform radio auto preset (ps) functionality
3. Touch to choose Local or Distance
4. Touch to turn on or turn off RBDS; Touch Set to enter RBDS page .
5. Touch to choose Stereo or Mono

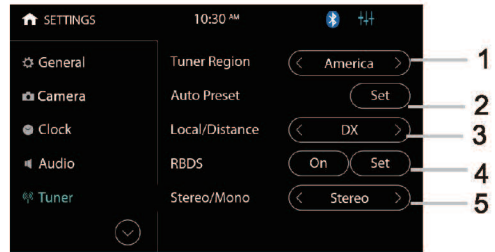

ILLUMINATION SETTINGS –Menu 5

1. Touch to turn on the illumination detection function
2. Touch to set screen brightness
3. Touch to set gamma brightness

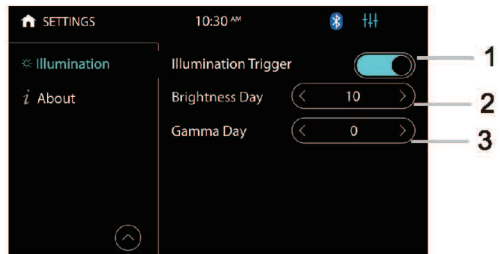

TUNER OPERATION

ABOUT SETTINGS –Menu 7

1. Touch to enter the touch calibration interface
2. Touch to view the version number of the machine.
3. Touch to restore the machine to factory status.
4. Touch to select whether it is necessary to display a warning interface when booting up.

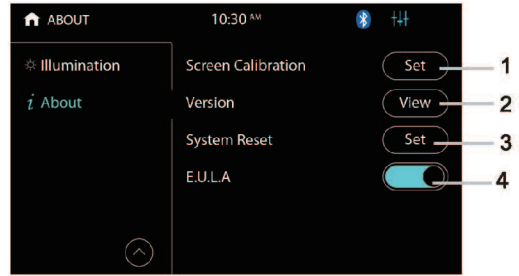

TUNER OPERATION

1. Touch to go back to the home page
2. Show PS,PTY and RT messages from RDS
3. Short press to seek backwards, long press to enter manual mode
4. Short press to seek forward, long press to enter manual mode
5. Short press to select the preset station, long press to save current Freq

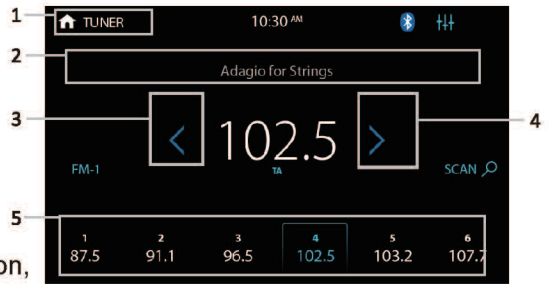

RBDS: Touch Setting >Tuner > RBDS > Set to enter the RBDS setup menu. You can choose what program type you'd like to listen to: news, sports, information, etc.

a.CT(Clock Time)

Turn on to automatically correct the current time every time the RBDS is opened.

b.TA(Traffic Announcement)

ON:When this is turned on the radio will automatically search for traffic station.

OFF:Turn off to end the TA function. In other modes, the traffic announcements will automatically switch to radio mode. Once the traffic announcements are complete it will automatically switch to the previous mode.

c.AF(Auto Frequency)

When the AF function is turned on, the radio will automatically fine tune to other frequencies when the received stations become weak. A warning message will be displayed on the screen when receiving emergency announcements.



DISC/CD/USB/SD PLAYBACK

d.PTY(Programming Type)

Touch the button to display program types. Search for stations according to program type.

NOTE: If RBDS is turned OFF, AF/TA/PTY will not function.

DVD MODE OPERATION

1. Touch to select title/chapter of DVD
2. Short press to move to the previous chapter, long press to rewind quickly.
3. Touch to playback/pause
4. Short press to move to the next chapter, long press to fast forward quickly.
5. Touch to enter DVD root menu
6. Go to the next page of the menu bar
7. Go to the previous page of the menu bar
8. Touch to change the repeat mode in the following sequence:
DVD:repeat all, repeat off, repeat chapter, repeat title
VCD(PBC off):repeat all, repeat off, repeat single
9. Touch to change random play mode
10. Touch to enter video adjust page
11. Touch to enter DVD title menu
12. Touch to select the subtitle language if the disc is recorded in multiple languages
13. Go to the next page of menu bar
14. Touch to switch video between 4:3 and 16:9
15. Touch to select DVD audio language
16. Touch to select DVD video angle

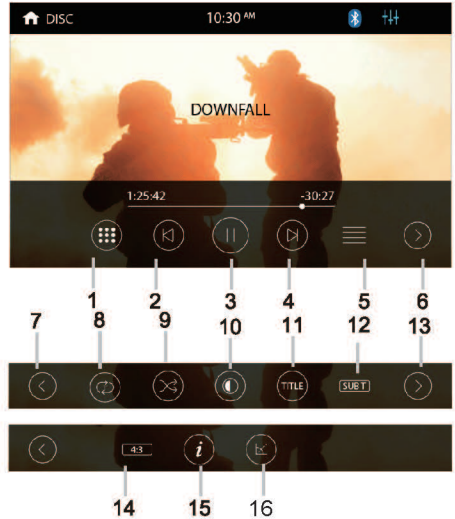

NOTE: When properly installed, a video cannot be displayed unless the parking brake is applied. If the parking brake wire is not installed correctly, the following message will appear.

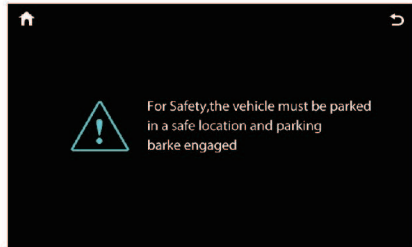

DISC/CD/USB/SD PLAYBACK

MEDIA PLAYING—CD AUDIO

1. Show the music's ID3 information
2. Time bar: show the total time and playing time of the present song
3. Touch to change play mode: repeat all, repeat directory, repeat single, sequential play and shuffle play
4. Touch to return to previous chapter
5. Touch to playback/pause
6. Touch to go to the next chapter
7. Touch to enter file list page

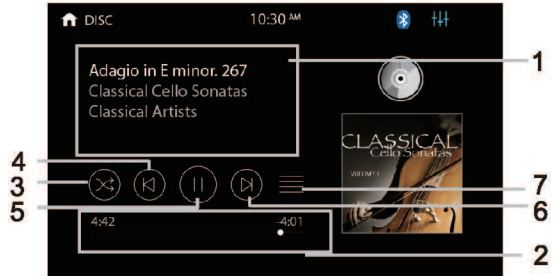

CD SOURCE MENU

Touch the SOURCE MENU (ICON 5) to access the CD track menu to view or change tracks manually. Touch again to return to playback.

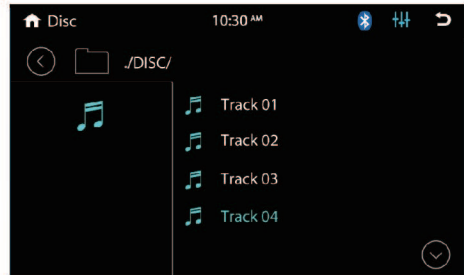

USB/SD MUSIC/VIDEO/PICTURE

Press USB/SD in the main menu. The music menu is similar to the disc music menu except there is more ID3 information on it (such as song name & singer).

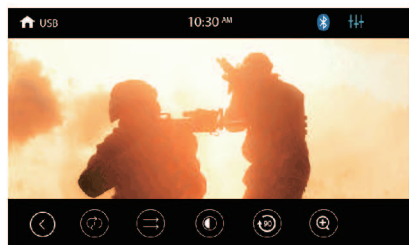
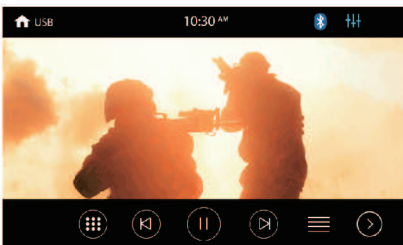
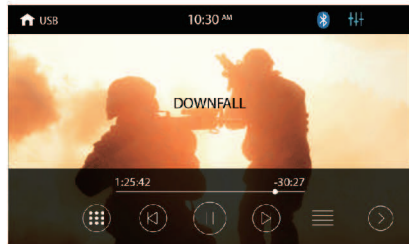
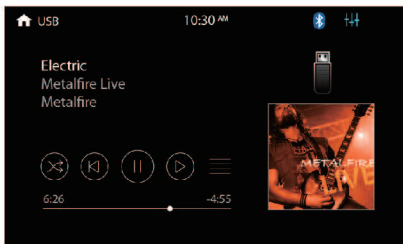

BLUETOOTH OPERATION

BLUETOOTH OPERATION MENU

Click the phone icon to enter the Bluetooth function interface.

1. Bluetooth setting menu:

a. Turn Bluetooth on and off.

Turn on and the display loops between the gray Bluetooth icon, the white Bluetooth icon. The icon will turn blue when a phone is paired.

b. Connect automatically.

c. Answer automatically.

d. PIN code: The default password is "0000" and can be changed by clicking "0000".

e. Default Bluetooth name for this unit:

Boss Audio BV9351B

2. Function area:

a. Click to see the dialing keypad. Users can dial phone numbers and make calls.

b. Click to see the Bluetooth phonebook menu.

c. Click to see the Bluetooth call history.

d. Bluetooth pairing interface.

e. Bluetooth setting menu.

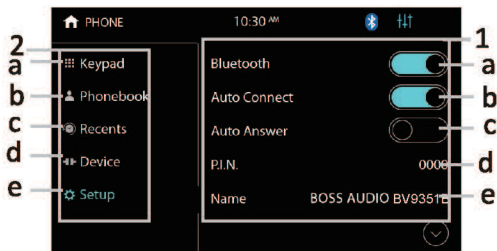

BLUETOOTH KEYPAD

1. Shows the number dialed in.

Press to delete wrong numbers.

2. Key area.

3. Touch to call out.

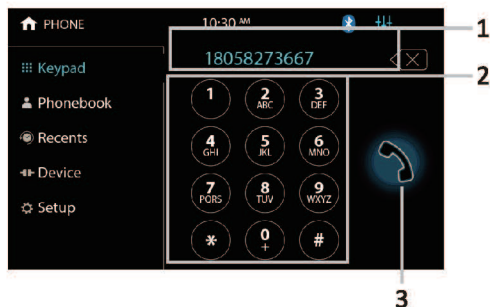

BLUETOOTH CALL

1. Show contact name.

2. Touch to select talk through phone or through Bluetooth.

3. Touch to mute or un-mute mic.

4. Keypad area.

5. Press to hang up the phone call.

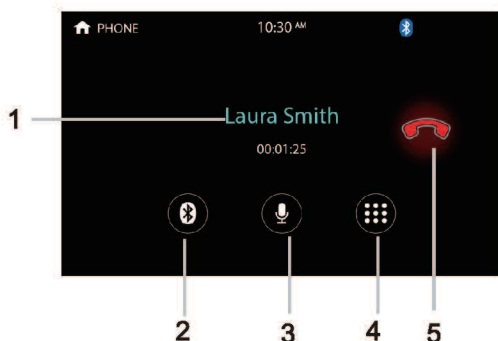

BLUETOOTH OPERATION

BLUETOOTH PHONEBOOK

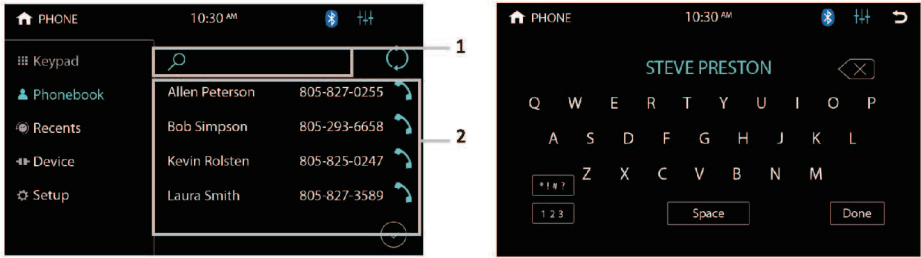

1. Touch to search for a name or phone number.
2. Contact list.

BLUETOOTH PHONE CALL HISTORY

1. Click to sync phonebook.
2. Touch to show missed calls.
3. Touch to show the dialed phone number.
4. Touch to show the received phone number.

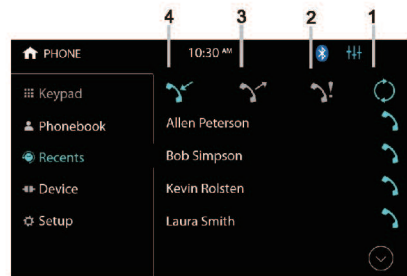

BLUETOOTH MUSIC-A2DP

1. Previous song.
2. Play/pause.
3. Next song.
4. Enter EQ setting menu.

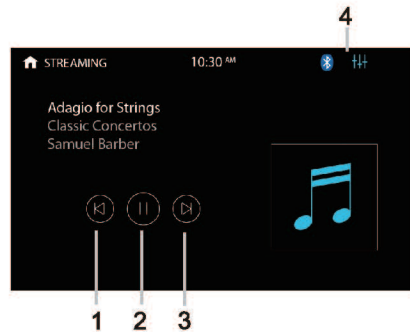

BLUETOOTH PAIR DEVICE

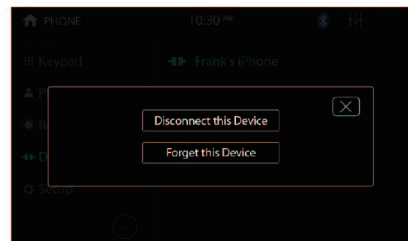

PHOTOS

1. Keypad: enter number to select file.
2. Previous pic.
3. PLAY/PAUSE: PLAY/PAUSE: Touch to start picture playing mode. Press again to pause. During picture playing mode, each picture will be played for 5 seconds and then automatically move to the next if the PLAY/PAUSE button is not pressed.
4. Next picture.
5. List: Press to enter file list.
6. Go to the next page of the menu bar..
7. Go to the previous page of the menu bar.
8. Select repeat mode.
9. Random play.
10. Touch to enter the video adjust page.
11. Turn right 90 degrees.
12. Zoom out/in the present picture.



CAMERA/AUX/AV MENU

FRONT CAMERA:

Turn on the switching interface of rear camera and front camera at the same time

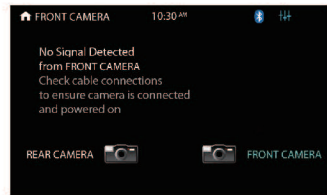

REAR CAMERA:

Rear view function. The rear view video signal can display automatically when reversing the car and then return the screen to the last source when the car is moved out of reverse.

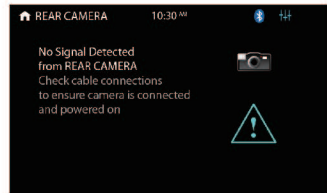

AUX IN:

External audio input function Connect the audio device to the unit by the 3.5mm jack in front of the panel and touch AUX IN icon.

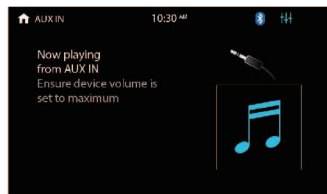

AV INPUT:

External video and audio input function Connect the video and audio device to the unit by the RCA jacks and touch AV INPUT icon.

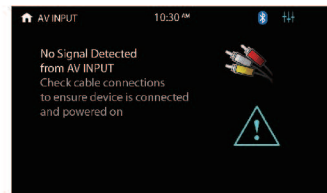

TROUBLESHOOTING

Media displayed	Cause	Corrective Action
Loading	Disc is being read	
No Disc/Bad Disc	Disc is dirty	Clean the disc
	Disc is upside down	Insert Disc in right way
Unknown Disc	Unsupported Disc type	Check the disc and change
Error	Illegal mechanism operation	Press EJECT for 5s to reset loading mechanism
Problem	Cause	Corrective Action
Unit will not power on	Radio fuse blown	Install new fuse with right rating
	Car battery fuse blown	Install new fuse with right rating
	Illegal operation	Press the RESET button
Screen touch is insensitive	Place of touch screen is uncalibrated	Go to setup menu and set the calibration
No audio output	Improper audio output connection	Check wiring and correct
	VOLUME 0	Turn up the volume
Low audio output	Heavily biased volume balance	Check and adjust the channel balance to the center position
Poor sound quality or distortion	Speaker power rating not compatible with unit	Connect proper speakers
	Speaker short circuit	Check wiring
Weak station searching	Auto antenna is not properly connected	Connect the auto antenna properly
	LOCAL function is activated	Turn LOCAL function OFF

TROUBLESHOOTING

Problem	Cause	Corrective Action
No image	Incorrect connection to parking wire	Check wiring and correct
	Parking brake is not engaged	Stop vehicle in safe place and set parking brake ON
Flashing image or interference appears on screen	Improper video signal connections	Check wiring and correct
Improper image, improper height/width radio display	Improper aspect ratio setup	Use correct aspect ratio setting
Cannot insert Disc	Disc already inside unit	Eject the current Disc and insert the new one
Loss of audio, music stops	Disc is scratched or warped	Use a new one in good condition
	Disc is dirty or wet	Clean the Disc



BEST WARRANTY

IN THE INDUSTRY

Keep in Touch! Register Your Product Online



To register your product, scan this QR code with your smart device and fill in the online form. You can also find the online registration form at: www.bosssaudio.com/support

Your product may qualify for a FREE EXTENDED WARRANTY.

**Please see www.bosssaudio.com/policies
for the qualifications and details of this program.**

THANK YOU

Welcome to the BOSS AUDIO SYSTEMS family.
Proud audiophiles since 1987.



GET INVOLVED

WE ARE A COMMUNITY!

We read all product feedback, so please share your experience with us and with others!

NEED SUPPORT?

Our U.S. based Customer Support Team is standing by to help you with your inquiries.

CUSTOMER CARE: (805) 751-4853 & Live Chat
ONLINE SUPPORT: www.bossaudio.com/support

JOIN OUR COMMUNITY

Join our #BOSSInsiders Program and have an impact on product updates & releases. Apply at www.bossinsiders.com to test and have an influence on future products.



Stay connected with the BOSS Audio Systems community plus get tips & tricks on products and installs.

[@BOSSAudioSystems](https://www.instagram.com/BOSSAudioSystems)