

YAMAHA RX-700U *RS*

Natural Sound Stereo Receiver

65W + 65W (8Ω) RMS Output Power, 0.009% THD, 20-20,000 Hz

16-Station Random Preset Tuning

IF Count Direct PLL Synthesizer Tuning System

Continuously Variable Loudness Control

Rec-out Selector

High Dynamic Power, Low Impedance Drive Capability

Video Enhancer for Dubbing & Monitor with 2 Video Input Selectors

Wireless Remote Control Capability

Thank you for purchasing the YAMAHA RX-700U stereo receiver.

OWNER'S MANUAL



CONTENTS

Safety Instructions	1
Caution	2
Supplied Accessories	3
Control Parts and Their Functions	4
Using the Remote Control Transmitter	10
Connections	11
Operations	15
Troubleshooting	17
Specifications	18

IMPORTANT!

Please record the serial number of your unit in the space below.

Model: **RX-700U**

Serial No.:

The serial number is located on the rear of the unit.

Retain this Owner's Manual in a safe place for future reference.

WARNING

To prevent fire or shock hazard, do not expose this appliance to rain or moisture.

SAFETY INSTRUCTIONS

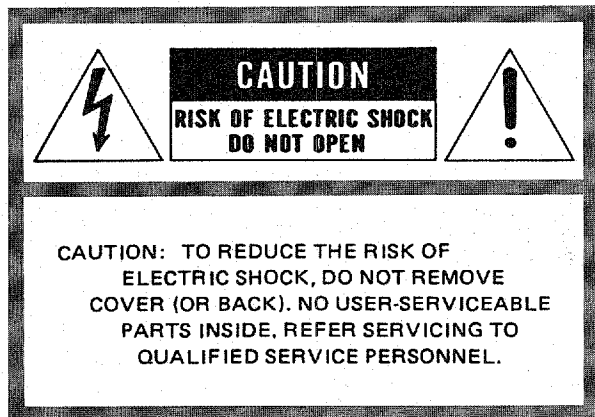

• Explanation of Graphical Symbols



The lightning flash with arrowhead symbol, within an equilateral triangle, is intended to alert you to the presence of uninsulated "dangerous voltage" within the product's enclosure that may be of sufficient magnitude to constitute a risk of electric shock to persons.



The exclamation point within an equilateral triangle is intended to alert you to the presence of important operating and maintenance (servicing) instructions in the literature accompanying the appliance.

- 1 Read Instructions – All the safety and operating instructions should be read before the appliance is operated.
- 2 Retain Instructions – The safety and operating instructions should be retained for future reference.
- 3 Heed Warnings – All warnings on the appliance and in the operating instructions should be adhered to.
- 4 Follow Instructions – All operating and other instructions should be followed.
- 5 Water and Moisture – The appliance should not be used near water – for example, near a bathtub, washbowl, kitchen sink, laundry tub, in a wet basement, or near a swimming pool, etc.
- 6 Carts and Stands – The appliance should be used only with a cart or stand is recommended by the manufacturer.
- 7 Wall or Ceiling Mounting – The appliance should be mounted to a wall or ceiling only as recommended by the manufacturer.
- 8 Ventilation – The appliance should be situated so that its location or position does not interfere with its proper ventilation. For example, the appliance should not be situated on a bed, sofa, rug, or similar surface that may block the ventilation openings; or placed in a built-in installation, such as a bookcase or cabinet that may impede the flow of air through the ventilation openings.
- 9 Heat – The appliance should be situated away from heat sources such as radiators, or other appliances that produce heat.
- 10 Power Sources – The appliance should be connected to a power supply only of the type described in the operating instructions or as marked on the appliance.
- 11 Power-Cord Protection – Power-supply cords should be routed so that they are not likely to be walked on or pinched by items placed upon or against them, paying particular attention to cords at plugs, convenience receptacles, and the point where they exit from the appliance.
- 12 Cleaning – The appliance should be cleaned only as recommended by the manufacturer.
- 13 Nonuse Periods – The power cord of the appliance should be unplugged from the outlet when left unused for a long period of time.
- 14 Object and Liquid Entry – Care should be taken so that objects do not fall into and liquids not spilled into the inside of the appliance.
- 15 Damage Requiring Service – The appliance should be serviced by qualified service personnel when:
 - A. The power-supply cord or the plug has been damaged; or
 - B. Objects have fallen, or liquid has been spilled into the appliance; or
 - C. The appliance has been exposed to rain; or
 - D. The appliance does not appear to operate normally or exhibits a marked change in performance; or
 - E. The appliance has been dropped, or the cabinet damaged.

RX-700U

CAUTION: READ THIS BEFORE OPERATING YOUR RX-700U

16 Servicing – The user should not attempt to service the appliance beyond those means described in the operating instructions. All other servicing should be referred to qualified service personnel.

17 Power Lines – An outdoor antenna should be located away from power lines.

18 Grounding or Polarization – The precautions that should be taken so that the grounding or polarization means of an appliance is not defeated.

19 Outdoor Antenna Grounding – If an outside antenna is connected to the receiver, be sure the antenna system is grounded so as to provide some protection against voltage surges and built up static charges.

Section 810 of the National Electrical Code, ANSI/NFPA No. 70-1984, provides information with respect to proper grounding of the mast and supporting structure, grounding of the lead-in wire to an antenna discharge unit, size of grounding conductors, location of antenna-discharge unit, connection to grounding electrodes, and requirements for the grounding electrode.

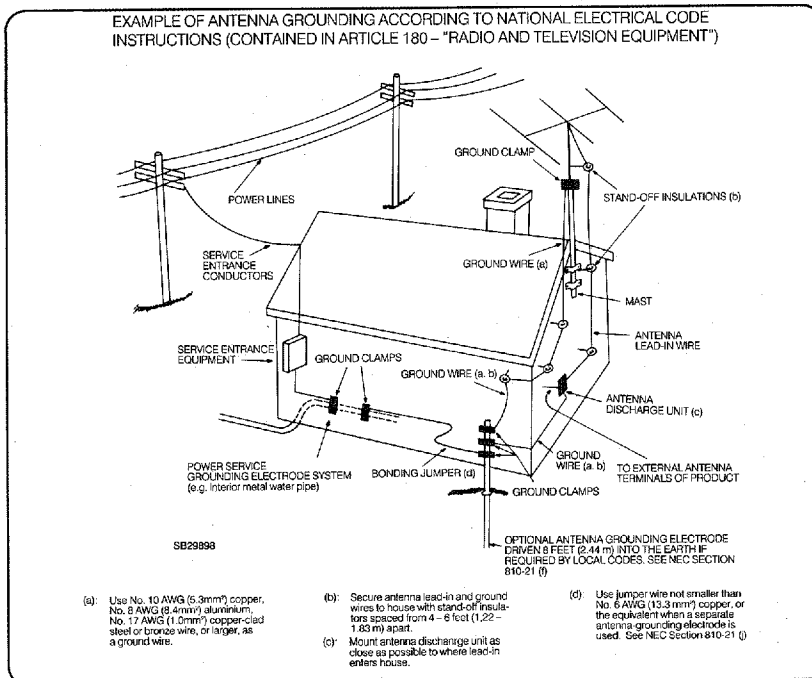

1. The RX-700U is a sophisticated receiver. To ensure proper operation for the best possible performance, please read this manual carefully.
2. Choose the installation location of your RX-700U carefully. Avoid placing it in direct sunlight or close to a source of heat. Also avoid locations subject to vibration and excessive dust, heat, cold or moisture. Keep it away from such sources of hum as transformers or motors.
3. Do not open the cabinet as this might result in damage to the set, or electrical shock. If a foreign object should get into the set, contact your dealer.
4. To prevent lightning damage, pull out the power cord and remove the antenna cable during an electrical storm.
5. When removing the power plug from the wall outlet, always pull directly on the plug; never pull the cord itself.
6. Do not use force when using the switches.
7. When moving the set be sure to first pull out the power plug and remove cords connected to other equipment.
8. Do not attempt to clean the RX-700U with chemical solvent as this might damage the finish. Use a clean, dry cloth.
9. Be sure to read the "Troubleshooting" section for advice on common operating errors before concluding that your RX-700U is faulty.
10. Keep this manual in a safe place for future reference.

SUPPLIED ACCESSORIES

After unpacking, check that the following parts are contained.

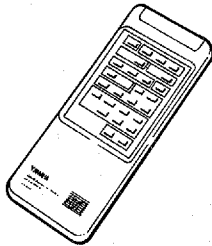
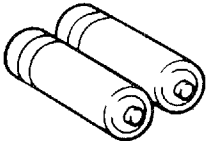
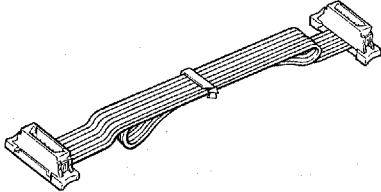
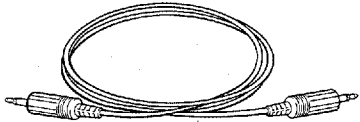
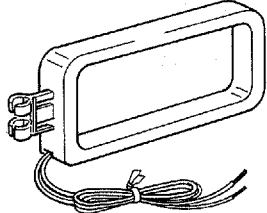
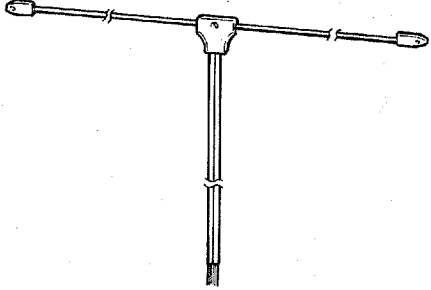
<p>Remote control transmitter</p>  A handheld remote control transmitter with a numeric keypad and several function buttons.	<p>Batteries</p>  Two cylindrical batteries, likely AA or AAA, shown side-by-side.	<p>Remote control cable (6-pin)</p>  A flat ribbon cable with a 6-pin connector at one end and a smaller connector at the other.
<p>Remote control cable (mini-plug)</p>  A coiled cable with a mini-plug connector at one end and a standard audio jack at the other.	<p>AM loop antenna</p>  A rectangular loop antenna with a small rectangular box on one side and a cable extending from it.	<p>Indoor FM antenna</p>  A T-shaped indoor FM antenna with a central vertical stem and two horizontal arms.

RX-700U

CONTROL PARTS AND THEIR FUNCTIONS

FRONT PANEL

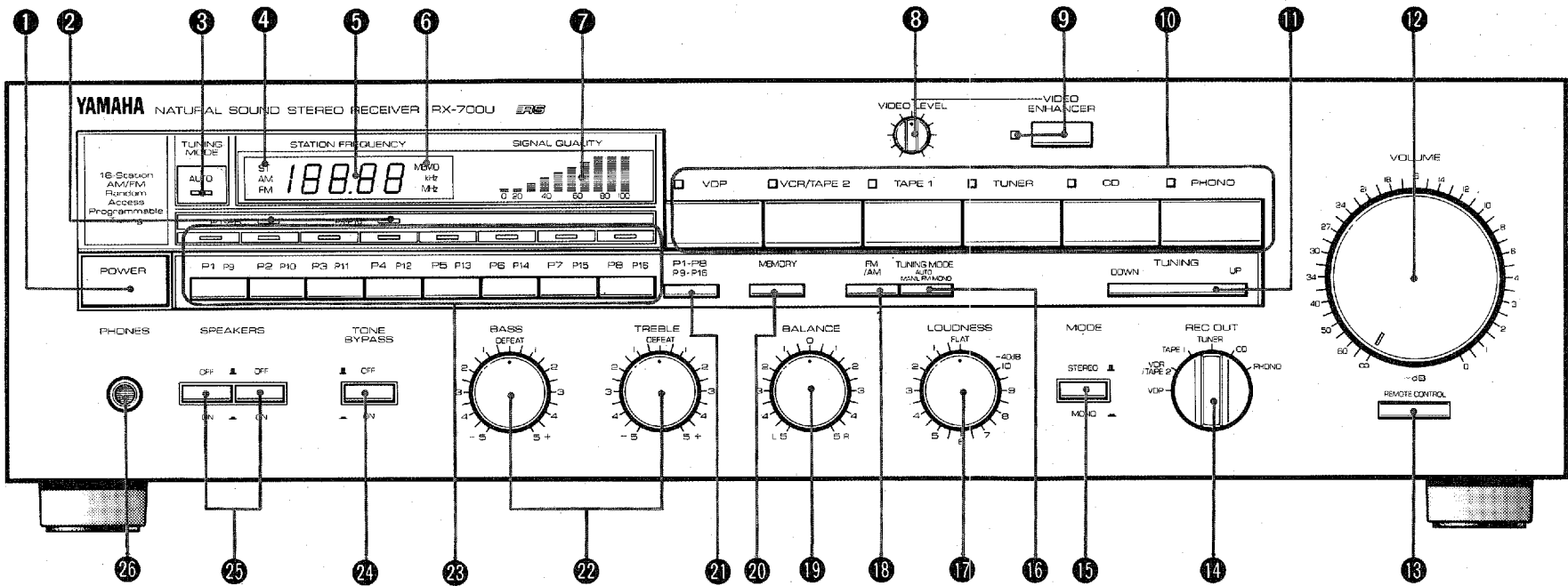

RX-700U

① POWER switch

Press this switch to turn the power on. Press the switch again to turn the power off.

② P1-P8/P9-P16 indicator

Indicates the range of the preset station buttons.

③ AUTO indicator

Lights when the TUNING MODE button is set to AUTO.

④ ST (stereo) indicator

Lights when an FM stereo broadcasting with a sufficient signal strength is received with the TUNING MODE button set to AUTO.

⑤ STATION FREQUENCY display

Displays the band and frequency of the received frequency.

⑥ MEMO (memory) indicator

Flickers for about 5 seconds when the MEMORY button is pressed.

⑦ SIGNAL QUALITY indicator

Indicates the level of the received frequency.

⑧ VIDEO LEVEL control

This control is used to increase or decrease the overall level of the enhanced video signal with the ENHANCER button set to ON. Normally, set this control to center click position.

⑨ VIDEO ENHANCER button and indicator

Press this button to operate the VIDEO LEVEL control.

⑩ Input selectors and indicators

Used to select the program source to be heard.

⑪ TUNING button

Press either side of the TUNING button to carry out auto or manual tuning.

⑫ VOLUME control

This control is used to raise or lower the output volume level.

⑬ REMOTE CONTROL sensor

This is used to receive signals from the remote control transmitter.

⑭ REC OUT selector

Used to select the program source to be recorded.

⑮ MODE switch

Used to select the monaural or stereo mode.

⑯ TUNING MODE button

Used to select the tuning mode between AUTO and MAN'L FM MONO. In the MAN'L FM MONO mode, an FM stereo broadcasting is received in monaural.

⑰ Continuous variable LOUDNESS control

This control allows you to retain full tonal range at any volume levels. Your ear loses sensitivity to high and low frequency ranges at low volume settings. This control provides an equalization curve based on human hearing.

To adjust the LOUDNESS control to your listening level, first, set the control to the FLAT position, increase the VOLUME control to your loudest listening level, then turn the LOUDNESS control counterclockwise to reduce the volume level.

⑱ FM/AM button

Press this button to select the reception band between FM and AM.

19 BALANCE control

Use this control to concurrently change the left and right output volume to the speaker terminals to compensate for sound imbalance caused from speaker settings or listening room condition.

20 MEMORY button

When this button is pressed, the MEMO indicator flickers in the display for about 5 seconds. During this period, press the desired preset station button to store the displayed frequency.

21 P1-P8/P9-P16 button

Press this button to change the range of preset station buttons. When this button is pressed, the selected range of the P1-P8/P9-P16 indicators flickers for about 5 seconds.

22 Tone controls

BASS

Used to increase or decrease the low frequency response. The DEFEAT position produces flat response.

TREBLE

Used to increase or decrease the high frequency response. The DEFEAT position produces flat response.

23 Preset station buttons and indicators

Up to 16 station frequencies and reception modes can be stored using the preset station button. The indicator above the selected preset station button lights.

24 TONE BYPASS switch

When this switch is set to ON, the input signal does not pass through the tone control circuitry so that it is unaffected by the tone control circuitry.

Use this switch to obtain pure sound and to check the tone control setting.

Set this switch to OFF to activate the tone control circuitry.

25 SPEAKERS selectors

Set this selector to select the speakers to be driven.

26 PHONES jack

Plug in the headphones to this jack. To shut off the sound from the speakers, set the SPEAKERS selectors to OFF.

RX-700U

REAR PANEL

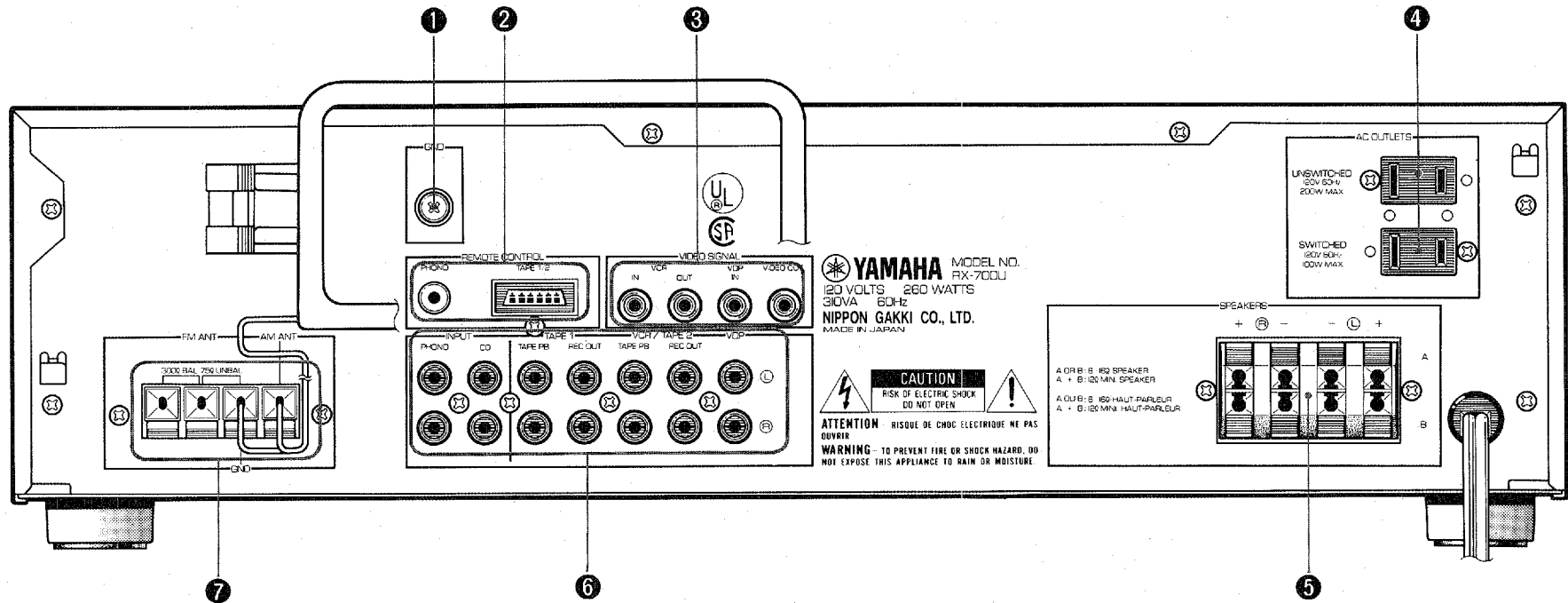

RX-700U

① GND terminal

Connect the ground wire of a turntable.

② REMOTE CONTROL connectors

Use these to connect compatible YAMAHA components (with an **RS** mark) to your receiver for remote control of each component.

PHONO

Connect to a turntable using the cable with a mini-plug connectors.

TAPE 1/2

Connect to a cassette tape deck using the cable with 6-pin connector.

③ VIDEO SIGNAL jacks

Use these to connect the video signal cords from your components to the receiver. They should be connected to the proper input/output jacks for each unit.

VCR

Connect a video recorder for both recording and playback.

VDP

Connect a video disc player.

VIDEO OUT

Connect a monitor TV.

④ AC OUTLETS

Use these to connect the power cords from your components to the receiver.

The power to the SWITCHED outlets is controlled by the receiver's POWER switch or remote control transmitter's POWER key. They will supply power to any component whenever this unit is turned on.

The power to the UNSWITCHED outlet is not controlled by the receiver. It will continually supply power to any unit connected.

The maximum power (total power consumption of components) that can be connected to the SWITCHED AC OUTLET is 100 watts and to the UNSWITCHED AC OUTLET is 200 watts.

⑤ SPEAKERS terminals

Two pairs of speakers A and B can be connected to these terminals.

⑥ Audio signal connection jacks

Use these to connect the audio signal cords from your components to the receiver. They should be connected to the proper input/output jacks for each unit. Be sure that L and R channels are connected consistently.

VDP

Connect an audio signal of the video disc player.

VCR/TAPE 2

Connect an audio signal of the video cassette recorder or second tape deck for both recording and playback.

TAPE 1

Connect a first tape deck for both recording and playback.

CD

Connect a compact disc player.

PHONO

Connect a turntable.

⑦ Antenna terminals

Connect an FM and AM antennas to these terminals.

RX-700U

REMOTE CONTROL TRANSMITTER

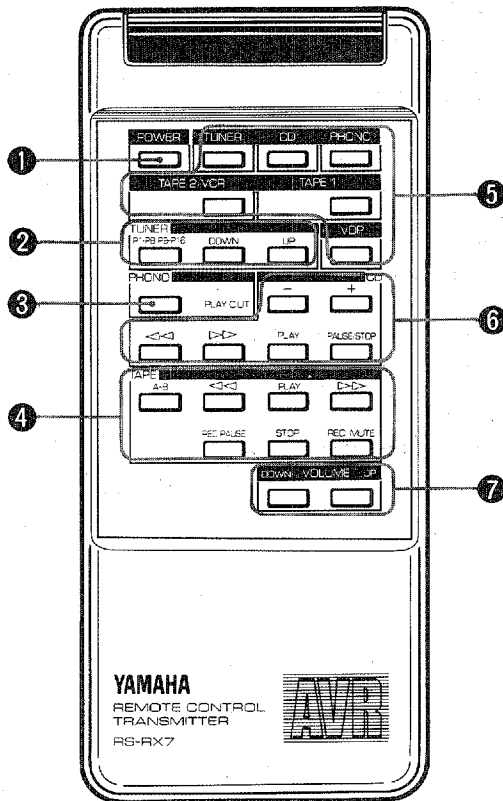

① POWER key

Press this key to turn the power of receiver ON and OFF.

② Tuner section

These keys are used to select the broadcast station preset.

UP

Press to select the preset station. Each time this key is pressed, the preset number is increased by one. (Ex: P7 → P8) When the key is pressed during the P8 (P16) station is received, the preset number will be changed to P1 (P9).

DOWN

Press to select the preset station. Each time this key is pressed, the preset number is decreased by one. (Ex: P8 → P7) When the key is pressed during the P1 (P9) station is received, the preset number will be changed to P8 (P16).

P1-P8/P9-P16

Each time this key is pressed, the preset station range is changed between P1-P8 and P9-P16 alternately.

③ Turntable section

This key is used to start and stop record play on the turntable with *RS* mark connected to this unit. This key functions same as the PLAY/CUT key on the turntable. Pressing this key starts record play and pressing it again stops playing.

④ Tape deck section

These keys are used to operate the cassette deck with *RS* mark connected to this unit.

A-B

Press to select the deck to be operated between the deck A and B on the double cassette deck.



Press to rewind the tape.

PLAY

Press to start tape play. When the double cassette deck is used, pressing the key starts tape play on the last playing deck.



Press to fast forward the tape.

REC/PAUSE

Press to set to recording pause mode.

STOP

Press to stop the tape.

REC MUTE

Press to make the non-recorded section during recording.

⑤ Input selector keys

Select the desired programs source with these keys.

RX-700U

USING THE REMOTE CONTROL TRANSMITTER

⑥ CD player section

The CD player with **RS** mark connected to this unit can be controlled directly with the remote control transmitter.

+

Press to advance to the beginning of the next tune.

-

Press to return to the beginning of the current tune. When this key is pressed at the beginning of the tune, the play will start at the beginning of the previous tune.

PAUSE/STOP

Used to set the player to pause or stop mode. Pressing the key once to stop play temporarily and pressing it again stops play.

PLAY

Press this key to start play.



Press to fast forward the tune.



Press to reverse the tune.

⑦ VOLUME control keys

These keys are used to adjust the volume level heard from the speakers connected to this unit.

The remote control transmitter supplied with your receiver is designed to control all the most commonly used features of the receiver. If the CD player, turntable and cassette deck connected to your receiver are YAMAHA components designed for remote control compatibility (components with an **RS** mark), then this remote control transmitter will also control various functions of each component. Please consult your YAMAHA dealer for information on which components are compatible with the remote control transmitter. Note that this Remote Control will directly operate any compatible YAMAHA CD player.

BATTERY INSTALLATION

The remote control unit uses 2 batteries (size "AA", R06). Install them according to the following illustration. Be sure that they are installed correctly.

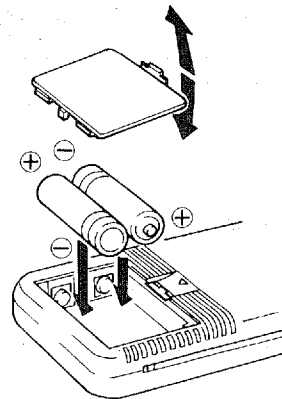

OPERATION RANGE

You must point the remote control unit toward the receiver and be within about 7 meters (23 feet) of it for proper operation.

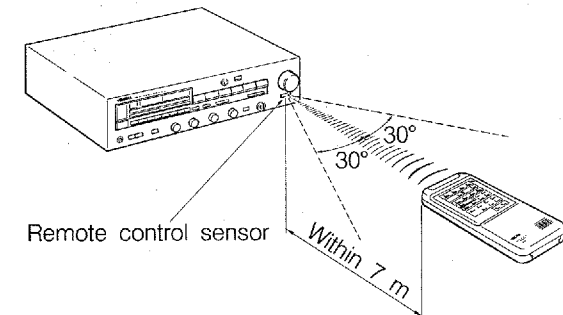

RX-700U

CONNECTIONS

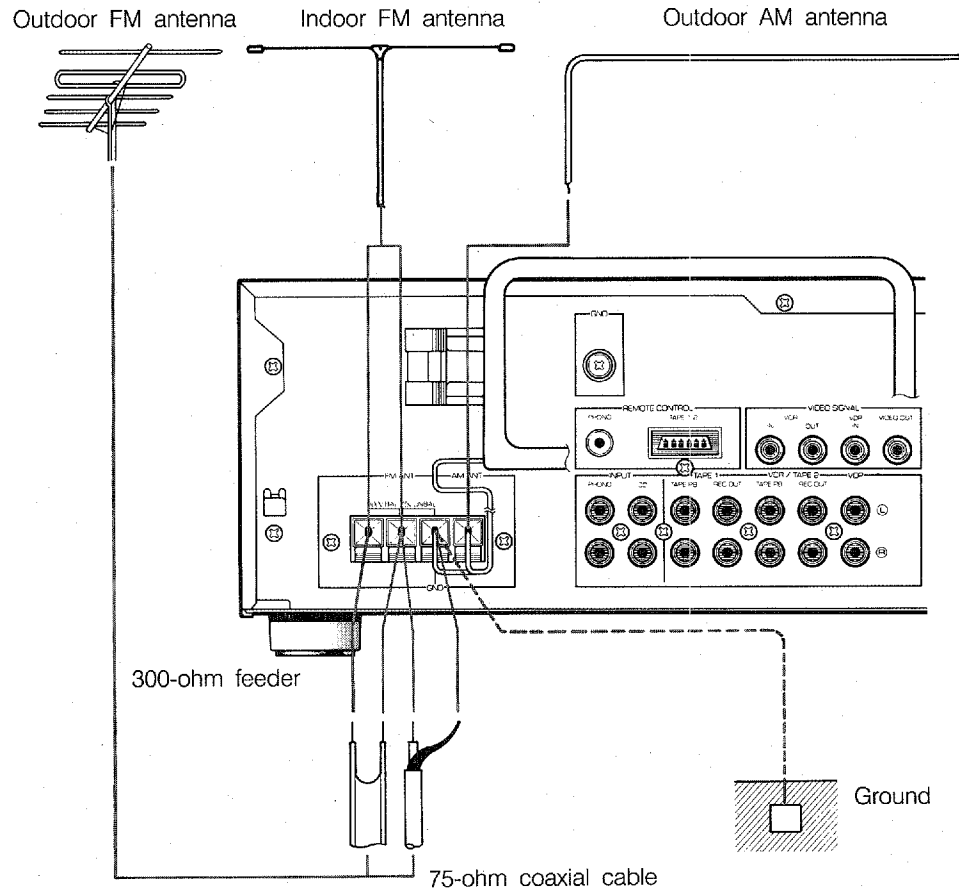

RX-700U

NOTES ON CONNECTIONS

- Be sure to turn off the power to all units before making any connections.
- The power cord and AC outlet have polarity indicators – a minus sign with the cord and sockets of a different size with the AC outlet. The purpose of this is to match polarities. Observe the polarity marks when connecting the AC outlets of receiver and other equipment.

ANTENNA CONNECTIONS

● AM loop antenna

Connect the AM loop antenna cords to the AM ANT and GND terminals.

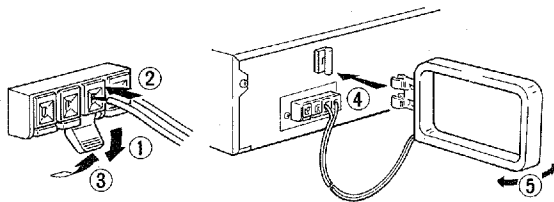

- ① Lower the knobs of the terminals.
- ② Connect the loop antenna cords to the AM ANT and GND terminals.
- ③ Raise the knobs.
- ④ Attach the loop antenna holder to the unit.
- ⑤ Move the antenna can be detached from the unit and hung on a wall.

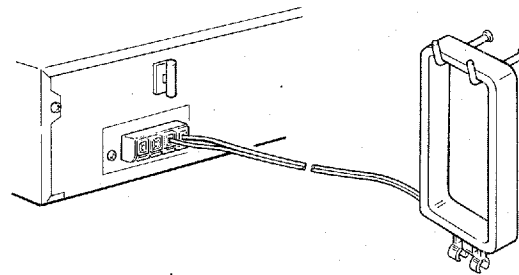

● Outdoor AM antenna

The end of the wire should be stripped of insulation and connected to the AM ANT terminal. At this time, keep the loop antenna connected.

● Supplied indoor FM antenna

Connect the supplied indoor antenna to the 300 Ω BAL. FM ANT terminals. Spread and move the antenna for best reception.

● Outdoor FM antenna

75-ohm coaxial cable connection

1. Strip the end of the coaxial cable.

2. Connect the coaxial cable to the 75 Ω UNBAL. FM ANT terminals.

300-ohm feeder connection

Connect the 300-ohm feeder to the 300 Ω BAL. FM ANT terminals.

RX-700U

AUDIO/VIDEO CONNECTIONS
Turntable with *RS* mark

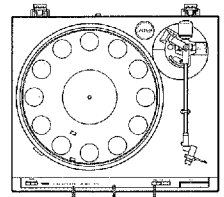

Video disc player



Monitor TV

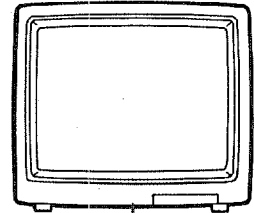

Speakers A

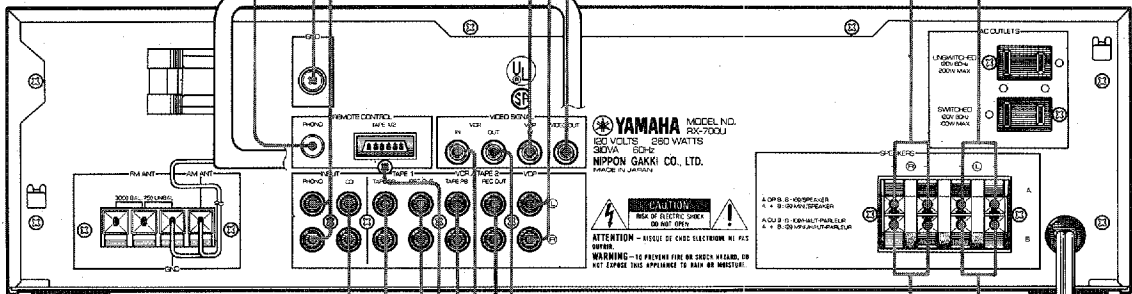
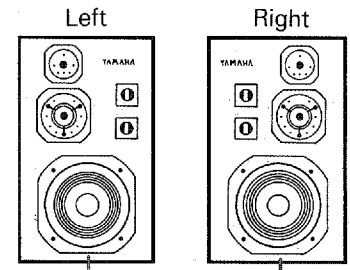

Compact disc player with *RS* mark



Tape deck with *RS* mark

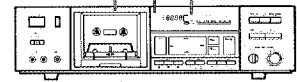

Video cassette recorder

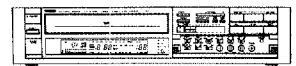

Speakers B

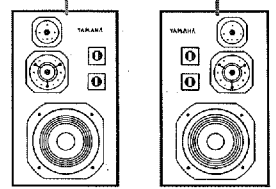

To AC outlet

RX-700U



● Power cord

Connect the power cord of your receiver to an AC outlet.

● Speakers

Connect the SPEAKERS terminals to your speakers with the proper gauge of wire, cut to be as short as possible. Press the speaker wire terminal tabs down, then insert the bare wires and secure them by releasing the tabs. If these connections are faulty, no sound will be heard from the speakers. Make sure that the polarity of the speaker wires is correct, that is, that the + and - markings are observed. If these wires are reversed, the sound will be unnatural and will lack bass. Do not coil up excess speaker wire or bundle the speaker cables with the power cords.

● Turntable

Connect the output cords of the turntable to the PHONO jacks, and connect the ground cord to the GND terminal. This should produce minimum hum, but in some cases better results are obtained with this cord disconnected.

● Compact disc player

Connect the output jacks of the compact disc player to the CD jacks.

● Video disc player

Connect the video output jack from a video disc player to the VDP jack. Connect the audio output jacks from a video disc player to the VDP jacks.

● Tape deck 1

Connect the cords from a cassette deck to the TAPE 1 jacks. The playback (LINE OUT) jacks go to the TAPE PB jacks, and the record (LINE IN) jacks go to the REC OUT jacks.

● VCR/tape deck 2

Connect the audio jacks of a second cassette recorder or video cassette recorder to the VCR/TAPE 2 jacks in the same way. Connect the video jacks of a video cassette recorder to the VIDEO VCR jacks in the same way.

● Monitor TV

Connect the video jack from a monitor to the VIDEO OUT jack.

● Remote control cable

The REMOTE CONTROL connectors are used when you have YAMAHA compatible components (with an *RC* mark).

These connections allow you to control the components from the supplied remote control transmitter.

Connect the remote control cables from the components to the correct connectors on your receiver (i.e. PHONO, TAPE).

Note that no cable is necessary for a compatible CD player as the remote control transmitter operates the player directly.

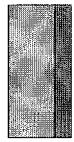

RX-700U

OPERATIONS

TO LISTEN TO RADIO PROGRAM

Auto Tuning

If signals are strong and there is no interference, quick automatic search tuning is possible.

1. Select the reception band with FM/AM button.
2. Press the TUNING MODE button so that the AUTO indicator lights up.
3. Use the TUNING button to tune.
The tuning will start automatically and stop at broadcast station frequency with a sufficient signal strength.
4. If the station where tuning stops is not the one you want, press the TUNING button once again.

Manual Tuning

Auto tuning may be impossible if the station signal is weak. If so, use manual tuning.

1. Select the reception band with FM/AM button.
2. Press the TUNING MODE button so that the AUTO indicator goes off.
3. Use the TUNING button to tune.
The frequency will change rapidly if the TUNING button is kept pressed. Release it slightly before reaching the desired frequency, and then press it intermittently until the desired frequency is reached.

Preset Tuning

The preset station button can be used to select, at a single touch, any desired station which has been preset.

1. Tune to the desired station using auto or manual tuning mode.
 2. Select the range of the preset station button with the P1-P8/P9-P16 button.
 3. Press the MEMORY button and then while the MEMO indicator is flickering, press the desired preset station button.
 4. To receive the preset station, select the range of the preset station with the P1-P8/P9-P16 button and press the desired preset station button.
- Follow the same procedure for other preset station buttons.
The new setting will be programmed in place of the former one.

● Memory back-up

The memory back-up circuit will prevent the programmed information from being lost even though the power is switched OFF for timer use or other temporary power failure. If, however, the unit is not used for a long time, the memory may be erased. If so, it can be re-programmed by simply following the original procedure.

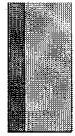

TO PLAY PROGRAM SOURCE

1. Select the program source to be heard with the input selector.
2. Play the program source.
3. Adjust the VOLUME and tone controls.

TO RECORD PROGRAM SOURCE

1. Select the program source to be recorded with the REC OUT selector.
2. To listen to program source to be recorded, press the corresponding input selector.
3. Play the program source to be recorded and set the tape deck or video cassette recorder to record mode.
4. To listen to other program source during recording, select the program source to be listened to with the input selector.

When your tape deck has three head monitoring capability, press the corresponding tape input selector to listen to just recorded signal.

The settings of the tone controls and VOLUME control do not affect the recording.

TO DUB AUDIO TAPES

1. Set the REC OUT selector to select the program source (TAPE 1 or VCR/TAPE 2) to be dubbed.
2. To listen to program source to be recorded, press the corresponding input selector.
3. Set the tape decks or video cassette recorders to play and record mode respectively.
4. To listen to other program source during dubbing, select the program source to be listened to with the input selector.

When your tape deck has three head monitoring capability, press the corresponding tape input selector to listen to just recorded signal.

The settings of the tone controls and VOLUME control do not affect the dubbing.

TO RECORD VIDEO SOURCES

1. Select the desired program source to be recorded with the REC OUT selector.
2. Set the VCR for recording to the record-pause mode.
3. Play the video source to be recorded and start recording with the recording VCR at the same time.

RX-700U

TROUBLESHOOTING

If the unit fails to operate normally, check the following points to determine whether the fault can be corrected by the simple measures suggested. If it cannot be corrected, or if the fault is not listed in the SYMPTOM column, disconnect the power cord and contact your dealer or service center for help.

	SYMPTOM	CAUSE	REMEDY
Amplifier	The receiver fails to turn on when the POWER switch is pressed.	Power cord is not plugged in or is not completely inserted.	Firmly plug in the power cord.
	No sound.	Incorrect output cord connections.	Connect cord properly. If the problem persists, the cables may be defective.
		Incorrect receiver operation.	Set the receiver controls to the correct input selection.
	Sound "hums".	Incorrect cord connections.	Firmly connect the audio plugs. If the problem persists, the cord may be defective.
	No picture.	Incorrect cord connections. Wrong video unit selected. Video unit not turned on.	Connect the video plugs correctly. Select correct video unit. Turn video unit on.
FM	FM stereo reception is noisy.	Because of the characteristics of FM stereo broadcasts, this is limited to cases where the transmitter is far away or the antenna input is poor.	Check the antenna connections. Try using a multiple element FM antenna.
	There is distortion and clear reception cannot be obtained even with a good FM antenna.	There is multipath interference.	Adjust antenna placement to eliminate multipath interference.
	A desired station cannot be tuned in with Auto tuning.	The station is too weak.	Use Manual tuning mode. Use high quality directional FM antenna.
AM	A desired station cannot be tuned in with Auto tuning.	Weak signal or loose antenna connections.	Tighten the AM loop antenna connections and rotate it for best reception. Use Manual tuning mode.
	There are continuous crackling and hissing noises.	These noise result from lightning, fluorescent lamps, motors, thermostats and other electrical equipment.	Use an outdoor antenna and a ground wire. This will help some what but it is difficult to eliminate all noise.
	There are buzzing and whining noises (especially in the evening).	A television set is being used nearby.	Move the television away.

SPECIFICATIONS

AUDIO SECTION

Minimum RMS Output Power per Channel	
8 ohms, 20 Hz to 20 kHz,	
0.009% THD	65 W
8 ohms, 1 kHz,	
0.009% THD	75 W
6 ohms, 20 Hz to 20 kHz,	
0.009% THD	75 W
Dynamic Power per Channel	
(IHF, 8 ohms)	101 W
(IHF, 6 ohms)	118 W
(IHF, 4 ohms)	150 W
Dynamic Headroom	
8 ohms	1.8 dB
Power Band Width	
8 ohms, 32.5 W,	
0.1% THD	10 Hz – 80 kHz
Damping Factor	
(8 ohms, 1 kHz)	50 or more
Input Sensitivity/Impedance	
PHONO	2.5 mV/47 k-ohms
CD/TAPE/VDP/VCR	150 mV/47 k-ohms
Input Sensitivity (New IHF)	
PHONO	0.31 mV
CD/TAPE/VDP/VCR	18.6 mV
Maximum Input Signal Level	
(1 kHz, 0.01% THD)	
PHONO	110 mV
Output Level/Impedance	
REC OUT	150 mV/1.5 k-ohms
Headphone Jack Rated Output/Impedance	
8 ohms, 0.009% THD	0.8 V/220 ohms
Frequency Response (20 Hz to 20 kHz)	
CD/TAPE/VDP/VCR	±0.5 dB

RIAA Equalization Deviation	
PHONO	±0.5 dB
Total Harmonic Distortion (20 Hz to 20 kHz)	
PHONO TO REC OUT	
(3 V)	0.005%
CD/TAPE/VDP/VCR to SP OUT	
(30 W/8 ohms)	0.009%
Signal to Noise Ratio (IHF-A Network)	
PHONO	
(5 mV Input Shorted)	92 dB
CD/TAPE/VDP/VCR	
(Shorted)	103 dB
Signal to Noise Ratio (New IHF)	
PHONO	76 dB
CD/TAPE/VDP/VCR	85 dB
Residual Noise	
(IHF-A Network)	140 µV
Channel Separation (1 kHz, Vol. -30 dB)	
PHONO Input Shorted	55 dB
CD/TAPE/VDP/VCR Input 5.1 k-ohms	
Terminated	52 dB
Tone Control Characteristics	
BASS:	
Boost/cut	±10 dB (50 Hz)
Turnover Frequency	350 Hz
TREBLE:	
Boost/cut	±10 dB (20 kHz)
Turnover Frequency	3.5 kHz
Filter Characteristics	
Built-in Subsonic Filter	..10 Hz, -12 dB/oct
Continuous Loudness	
Control	-40 dB (1 kHz)
	(Level related equalization)

VIDEO SECTION

Video Input	
Sensitivity/Impedance	1 V/75 ohms
Maximum Input Signal	2 V
Output Level/Impedance	1 V/75 ohms
Frequency Response	
10 Hz – 15 MHz	0 ± 1 dB
Signal to Noise Ratio	
White 50%	52 dB
Level Control	±3 dB

FM SECTION

Tuning Range	87.5 to 107.9 MHz
50 dB Quieting Sensitivity (IHF), 75 ohms	
Mono	1.55 µV (15.1 dBf)
Stereo	21 µV (37.7 dBf)
Usable Sensitivity	
(30 dB S/N Quieting)	
75 ohms, 1 kHz,	
100% mod.	0.8 µV (9.3 dBf)
Image Response Ratio	40 dB
IF Response Ratio	80 dB
Spurious Response Ratio	70 dB
AM Suppression Ratio	55 dB
Capture Ratio	1.5 dB
Alternate Channel Selectivity	55 dB
Signal to Noise Ratio	
(IHF)	
Mono	81 dB
Stereo	76 dB

RX-700U

Distortion

Mono:	
1 kHz	0.07%
Stereo:	
1 kHz	0.07%
Stereo Separation	
1 kHz	52 dB
Frequency Response	
30 Hz to 13 kHz	0 ±0.5 dB

AM SECTION

Tuning Range	530 to 1,610 kHz
Usable Sensitivity	250 μV/m
Selectivity	32 dB
Signal to Noise Ratio	50 dB
Image Response Ratio	40 dB
Spurious Response Ratio	50 dB
Distortion	0.3%

AUDIO SECTION

Output Level/Impedance	
FM (100% mod., 1 kHz)	500 mV /2.8 k-ohms
AM (30% mod., 400 Hz)	150 mV /2.8 k-ohms

GENERAL

Power Supply	AC 120 V, 60 Hz
Power Consumption	260 W
AC Outlets	
Switched	100 W max.
Unswitched	200 W max. (Total)
Dimensions	
(W x H x D)	435 x 126 x 288.5 mm (17-1/8" x 4-15/16" x 11-3/8")
Weight	6.3 kg (13 lbs. 14 oz.)
Accessories	Remote control cable (mini-plug) x 1 Remote control cable (6-pin) x 1 Remote control transmitter x 1 Battery x 2 AM loop antenna x 1 Indoor FM antenna x 1

Specifications subject to change without notice.

SINCE 1887  **YAMAHA**
NIPPON GAKKI CO., LTD. HAMAMATSU, JAPAN