

[Skip to content](#)

[Manuals+](#)

User Manuals Simplified.



## Razor 13173862 Power Core S80 Electric Hub Motor Scooter User Guide

April 18, 2022 April 20, 2022 [Leave a comment on Razor 13173862 Power Core S80 Electric Hub Motor Scooter User Guide](#)

[Home](#) » [Razor](#) » [Razor 13173862 Power Core S80 Electric Hub Motor Scooter User Guide](#)

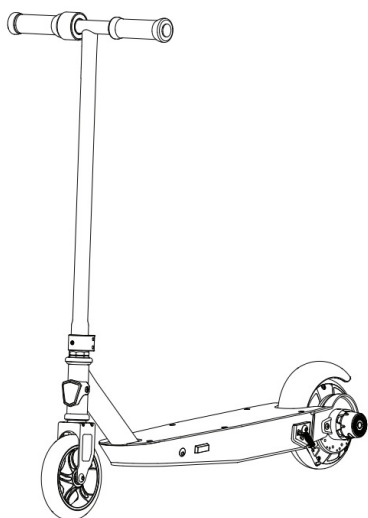

POWER CORE™ S80™  
ELECTRIC HUB MOTOR SCOOTER  
TROTINETTE À MOTEUR-ROUE ÉLECTRIQUE

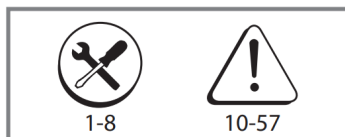

[www.razor.com](http://www.razor.com)

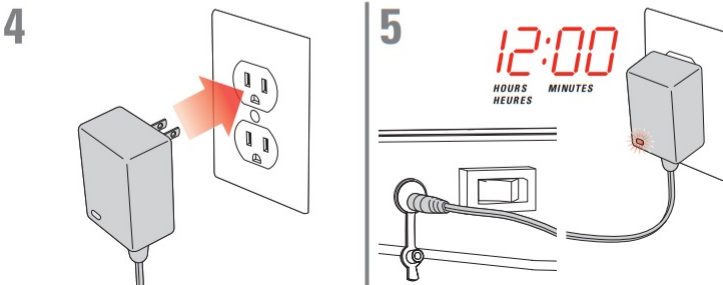
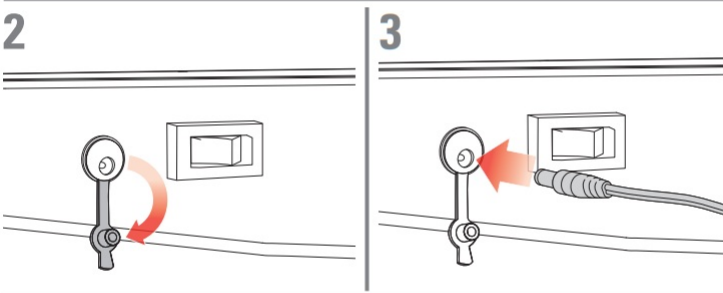
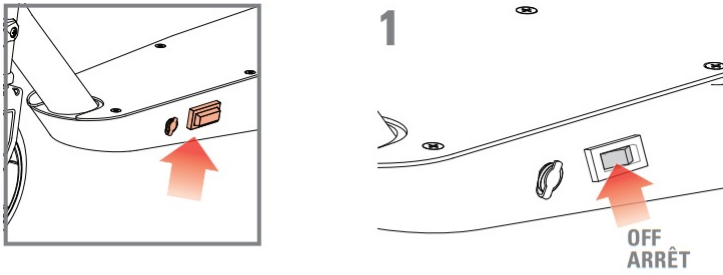
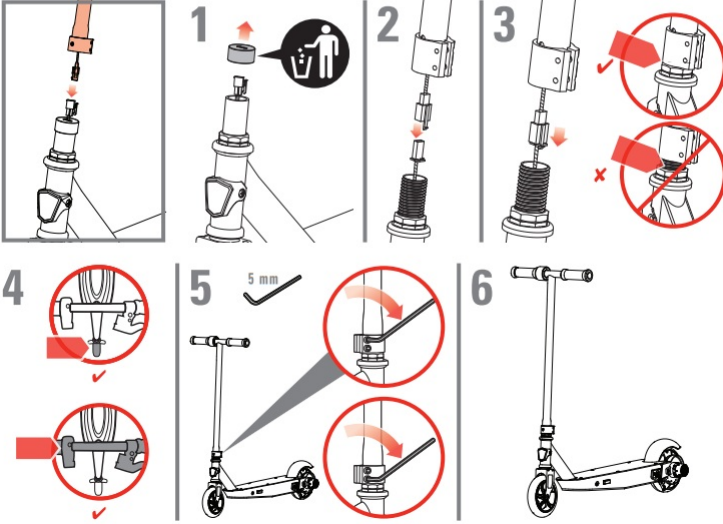
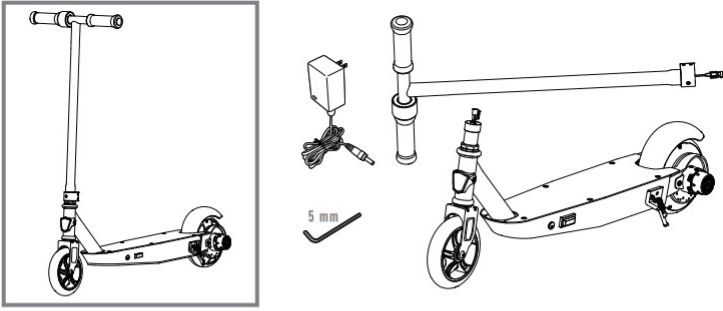

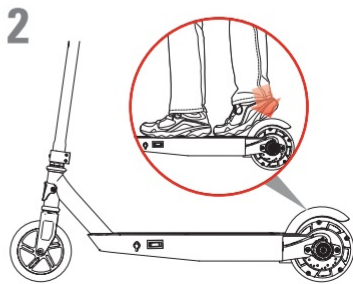
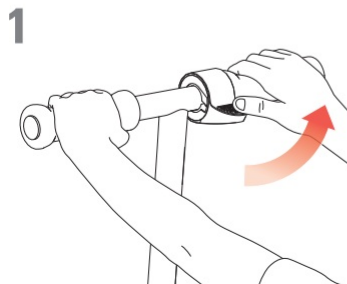
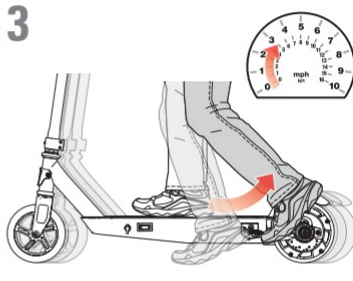
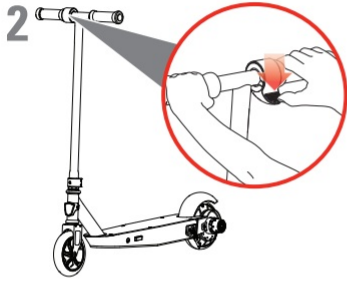
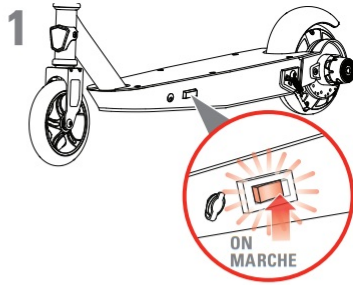

Contents [hide](#)

[1 Front wheel replacement](#)

[2 Rear Wheel/Hub Motor/Battery Replacement](#)

[3 Limited Warranty:](#)

[4 Documents / Resources](#)

[4.1 Related Manuals / Resources](#)

### Front wheel replacement

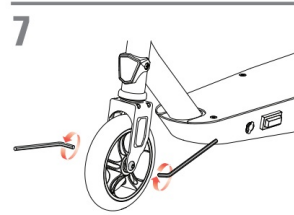
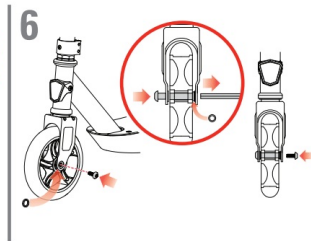
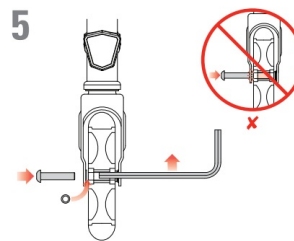
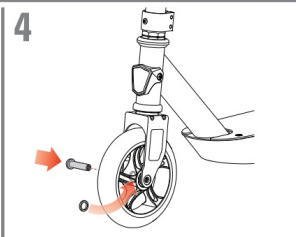
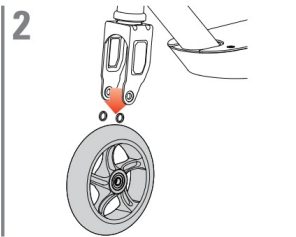
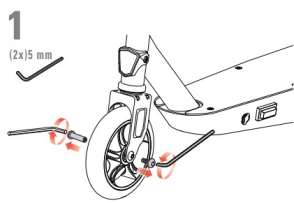

### Rear Wheel/Hub Motor/Battery Replacement

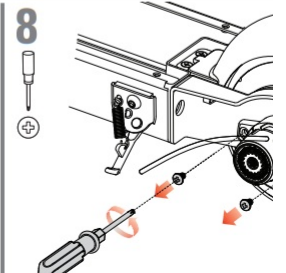
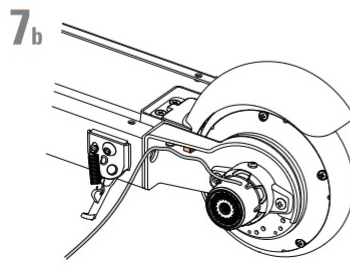
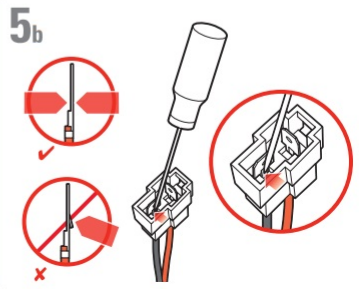
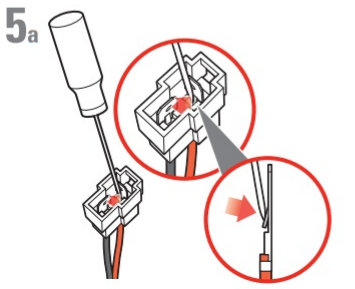
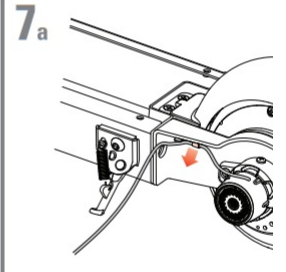
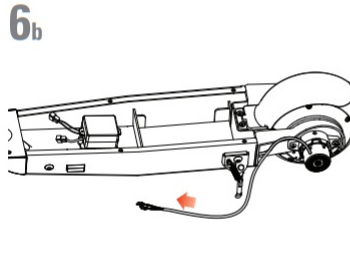
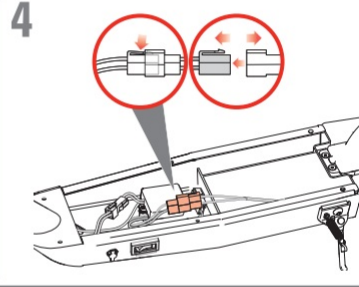
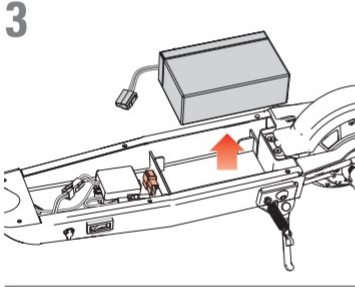
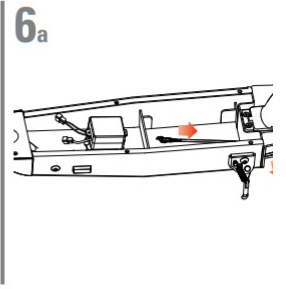
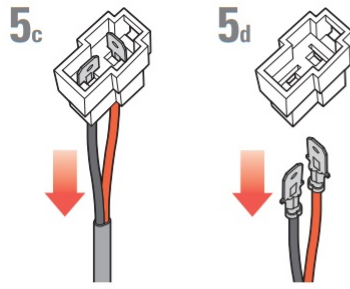
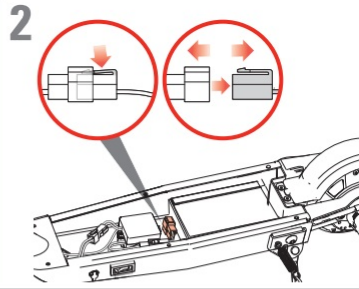
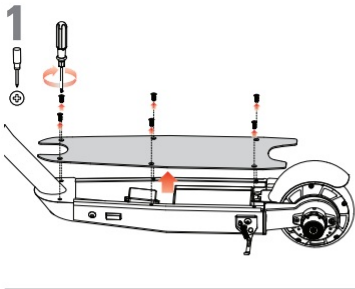

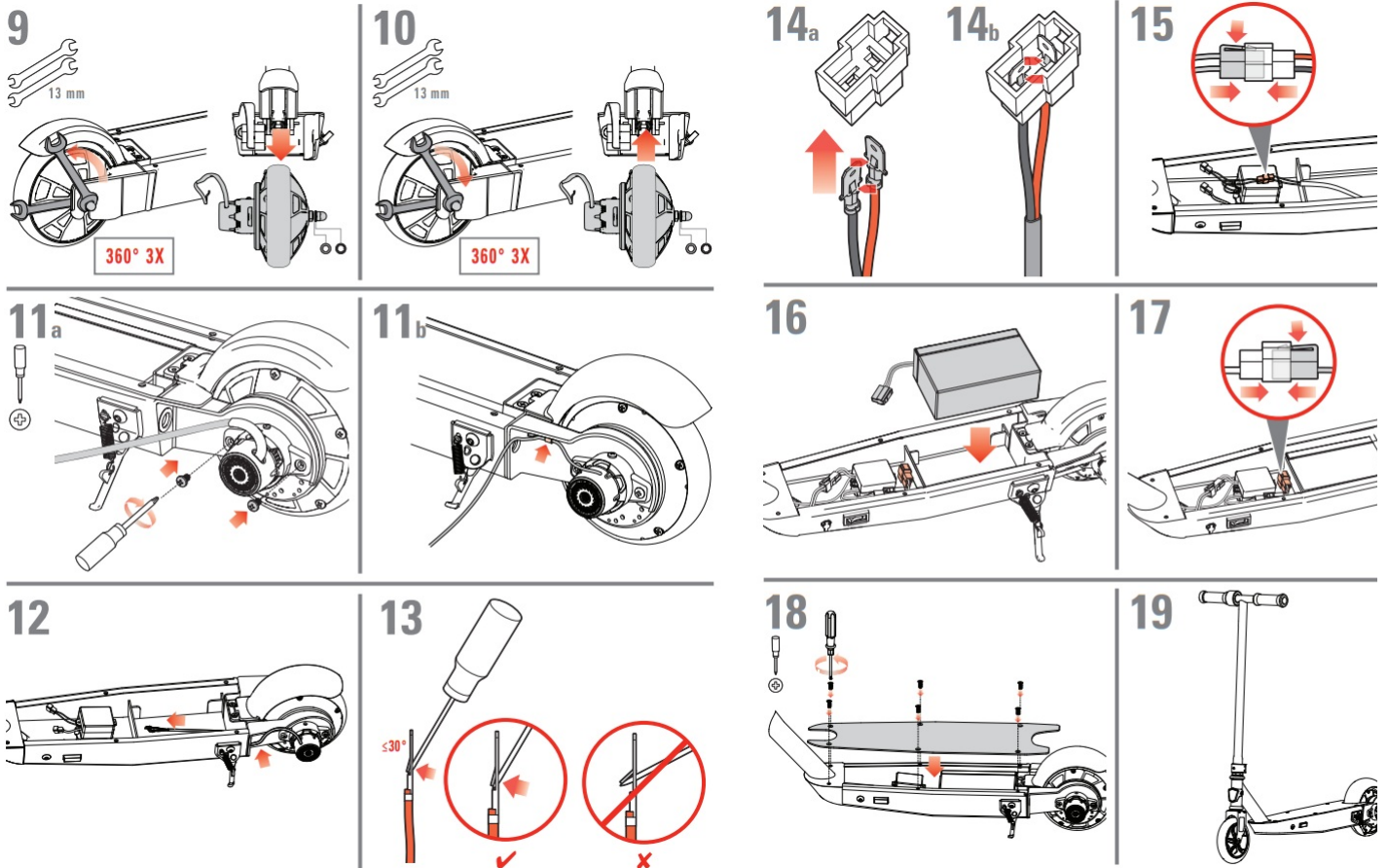

**! SAFETY PRECAUTIONS** during operation and maintenance Parents/adult supervisors read this page first

**PARENTS/SUPERVISING ADULTS MUST TEACH CHILDREN HOW TO SAFELY RIDE THIS SCOOTER.** If the rider fails to use common sense and heed these warnings, there is an increased risk of damage, serious injury, or possibly death.

**Riding an Electric Scooter Presents Potential Risks.**

- Like any riding product, an electric scooter can be hazardous (for example, falling off or riding into a hazardous situation). Electric scooters are, of course, meant to move and it is, therefore, possible for a rider to lose control or otherwise get into dangerous situations.
- Both children and adults responsible for supervising them must recognize that if such things occur, a rider can be seriously injured or possibly die, even when using safety equipment and taking other safety precautions.

**USE SCOOTERS AT YOUR OWN RISK AND USE COMMON SENSE.**

**Parental and Adult Responsibility and Supervision are Necessary**

Because scooters can be hazardous — and not every product is appropriate for every age or size of a child — different age recommendations are found within this category of product which is intended to reflect the nature of the hazards and the expected mental or physical ability, or both, of a child to cope with the hazards. Parents and supervising adults need to select riding products appropriate for the age of the child who will ride the electric scooter and take care to prevent children who may be too immature or inexperienced for a product's characteristics to endanger themselves around it.

- The recommended rider age for the Razor Power Core S80 electric scooter is 8 years of age and older. Any rider, even 8 or older, unable to fit comfortably on the scooter should not attempt to ride it. A parent's decision to allow his or her child to ride this product should be based on the child's maturity, skill and ability to follow rules. Keep this product away from small children and remember that it is intended for use only by persons who are, at a minimum, completely comfortable and competent while operating the scooter.
- Maximum rider weight 54 kg.
- Persons with any mental or physical conditions that may make them susceptible to injury, impair their physical dexterity or mental capabilities to recognize, understand, and follow safety instructions and to be able to understand the hazards inherent in scooter use, should not use or be permitted to use products inappropriate for their abilities. Persons with heart conditions, head, back, or neck ailments (or prior surgeries to these areas of the body), or pregnant women, should be cautioned not to operate such products.

**Check Scooter Before Use – Maintain After Use**

- Before use, confirm that any and all covers or guards are in place and in serviceable condition and that the brake is functioning properly. Make sure that the rear wheel has no flat areas or excessive wear.
- After use, maintain and repair the scooter in accordance with the manufacturer's specifications in this manual. Use only the manufacturer's authorized replacement parts. Do not modify this scooter from the manufacturer's original design and configuration.

**Acceptable Riding Practices and Conditions – Parents/adults should discuss these rules with their children.**

Protective equipment should be worn. Not to be used in traffic.

**Where to Ride the Scooter**

- Always check and obey any local laws or regulations which may affect the locations where the electric scooter may be used. Keep safely away from autos and motor vehicle traffic at all times and only use where allowed and with caution.
- Ride defensively. Be careful to avoid pedestrians, skaters, skateboards, scooters, bikes, children, or animals who may enter your path. Respect the rights and property of others.
- The electric scooter is intended for use on flat, dry surfaces such as pavement or level ground, without loose debris such as sand, leaves, rocks, or gravel.
- Wet, slick, bumpy, uneven, or rough surfaces may lessen traction and increase the risk of accidents.
- Do not ride your scooter in mud, ice, puddles, or water.
- Watch out for potential obstacles that could catch your wheel or force you to swerve suddenly or lose control.
- Avoid sharp bumps, drainage grates, and sudden surface changes.

- Do not ride your scooter in wet or icy weather and never immerse the scooter in water, as the electrical and drive components could be damaged by water or create other possibly unsafe conditions.
- Never risk damaging surfaces such as carpet or flooring by use of an electric scooter indoors.
- Never use near steps or swimming pools.

#### How to Ride the Scooter

- NOTE: This electric scooter must be moving at 5 km/h (3 mph) before the motor will engage.
- Do not activate the throttle unless you are on the product and in a safe outdoor environment suitable for riding.
- Hold the handlebars at all times while you are riding.
- Do not touch the brakes or hub motor on your scooter when in use or immediately after riding as these parts can become very hot.
- Avoid high speeds, as you might have on downhill rides, where you might lose control.
- Do not ride at night or when visibility is limited.
- Do not attempt or do stunts or tricks on your electric scooter. The scooter is not strong enough to withstand misuse and abuse such as jumping, curb grinding or any other type of stunts. Racing, stunt riding, or other maneuvers also increase the risk of loss of control or may cause uncontrolled rider actions or reactions. All of these could result in serious injury or possibly death.
- Never allow more than one person at a time to ride the scooter.
- Do not allow hands, feet, hair, body parts, clothing, or similar articles to come in contact with moving parts or wheels.
- Never use headphones or a cell phone when riding.
- Never hitch a ride with a vehicle.

#### Proper Riding Equipment, Clothes, Shoes

- Always wear proper protective equipment, such as an approved safety helmet (with chin strap securely buckled), elbow pads and a helmet that may be legally required by local law or regulation in your area. In addition, a long-sleeved shirt, long pants, and gloves are recommended.
- Always wear athletic shoes (lace-up shoes with rubber soles), never ride barefoot or in sandals, and keep shoelaces tied and away from the wheels, motor, and drive system.

#### Using the Charger

- Never modify the electric system. The alteration could cause a fire. The use of the wrong type of battery or charger could cause an explosion.
- BEFORE EACH USE: Charge the battery for AT LEAST 12 hours.
- Turn off after each ride. The battery may be unable to recharge if left "ON" without use.
- Do NOT store in freezing or below-freezing temperatures! Freezing temperatures will permanently damage the battery.
- The charger supplied with the electric scooter should be regularly examined for damage to the cord, plug, enclosure, and other parts. In the event of such damage, the scooter must not be charged until the charger has been repaired or replaced.
- Use only a charger recommended by Razor.
- The charger is not a toy. Charger should only be operated by an adult.
- Do not operate chargers near flammable materials or an open flame.
- Unplug the charger and disconnect from the scooter when not in use.
- Do not exceed charging time.
- Always disconnect the scooter from the charger prior to wiping it down or cleaning it with a damp cloth.

#### Limited Warranty:

This Limited Warranty is the only warranty for this product. There is no other express or implied warranty.

The manufacturer warrants this product to be free of manufacturing defects for a period of 90 days from the date of purchase. This Limited Warranty will be void if the product is ever:

- used in a manner other than for recreation or transportation;
- modified in any way;
- rented.



**CONTAINS A SEALED NON-SPILLABLE LEAD-ACID BATTERY.  
THE BATTERY MUST BE RECYCLED.**

#### EUROPE, MIDDLE EAST, AFRICA ASIA

Razor USA (Europe)      Razor USA (Asia)  
Handelsweg 2              P.O. Box 3610  
2742 RD Waddinxveen      Cerritos, CA 90703  
Netherlands              USA  
+44 (0) 120 267 2702      +81 50 7579 6622  
[info@razoreu.com](mailto:info@razoreu.com)      [info@razor-asia.com](mailto:info@razor-asia.com)

#### UNITED KINGDOM AND IRELAND

Razor USA LLC (UK)  
Unit 20  
Hartnoll Business Centre  
Post Hill, Tiverton  
Devon EX16 4NG  
UK  
+44 (0) 120 267 2702  
[info@razoreu.com](mailto:info@razoreu.com)  
Printed in China for Razor USA  
LLC.

#### DISTRIBUTED IN AUSTRALIA BY:

Funtastic Limited  
Suite 2.01, Level 2  
315 Ferntree Gully Road  
Mount Waverley VIC 3149,  
Australia  
+1 800 244 543  
[info@funtastic.com.au](mailto:info@funtastic.com.au)

#### AMERICAS

Razor USA LLC  
P.O. Box 3610  
Cerritos, CA 90703  
USA  
+1 866 467 2967  
Monday – Friday  
8:00 AM – 5:00 PM Pacific Time  
[customersupport@razorusa.com](mailto:customersupport@razorusa.com)

#### IMPORTED IN JAPAN BY B-PLUS ASIA

Razor USA LLC  
Kurokawa 3-1, Asaoka,  
Kawasaki, Kanagawa  
215-0035 JAPAN  
+81 (0) 44 328 9057 Tel  
+81 (0) 44 328 9067 Fax  
[info@razor-asia.com](mailto:info@razor-asia.com)



Copyright ©2003-2021 Razor USA LLC. All rights reserved. Razor® and the Razor logo design are among the registered trademarks of Razor USA LLC and/or its affiliated companies in the United States and/or select foreign countries. Power Core™ and the Power Core S80 logo design are trademarks of Razor USA LLC.



In the US and Canada only:

For more information regarding recycling rechargeable batteries, call toll-free 1-800-822-8837, or visit <http://www.call2recycle.org>

Au Canada et aux États-Unis seulement :

Pour plus de renseignements sur le recyclage des batteries rechargeables, appelez le numéro sans frais 1 800 822-8837 ou visitez

<http://www.call2recycle.org>



[www.razor.com](http://www.razor.com)

24L+CAN\_201218

**Documents / Resources**



[Razor 13173862 Power Core S80 Electric Hub Motor Scooter](#) [pdf] User Guide  
13173862, Power Core S80 Electric Hub Motor Scooter, 13173862 Power Core S80 Electric Hub Motor Scooter

**Related Manuals / Resources**



[Razor 476950 Power Core S85 Electric Hub Motor Scooter User Guide](#)

476950 Power Core S85 Electric Hub Motor Scooter 476950 Power Core S85 Electric Hub Motor Scooter User Guide  
www.razor.com...

[GOTRAX Electric Scooter Documentation](#)



[Razor C25/C25 SLA Electric Scooter User Manual](#)

C25/C25 SLA FOLDING MECHANISM - STEM REPLACEMENT PART # W13113290055 Required Tools: (Not included)  
A. 4 mm Allen...

[Mi Electric Scooter Manual](#)

Mi Electric Scooter Manual - Download [optimized]Mi Electric Scooter Manual - Download

**Leave a comment**

Your email address will not be published.

Comment

Name

Email

Website

Save my name, email, and website in this browser for the next time I comment.

[Manuals+](#)

- [home](#)
- [privacy](#)