

# **dji** DOCK 3

## DJI Matrice 4D Series

### Unmanned Aircraft Flight Manual

v1.2 2025.06

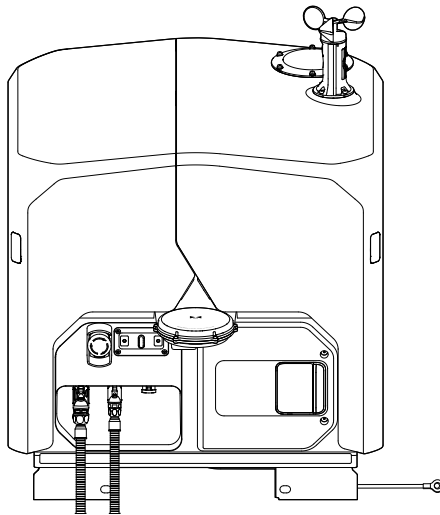
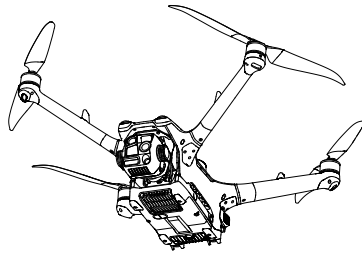



This document is copyrighted by DJI with all rights reserved. Unless otherwise authorized by DJI, you are not eligible to use or allow others to use the document or any part of the document by reproducing, transferring or selling the document. Only refer to this document and the content thereof as instructions to operate DJI products. The document should not be used for other purposes.

In the event of divergence among different versions, the English version shall prevail.

### **Searching for Keywords**

Search for keywords such as “battery” and “install” to find a topic. If you are using Adobe Acrobat Reader to read this document, press Ctrl+F on Windows or Command+F on Mac to begin a search.

### **Navigating to a Topic**

View a complete list of topics in the table of contents. Click on a topic to navigate to that section.

### **Printing this Document**

This document supports high resolution printing.

## Using this Manual

- 
-  • This product does not meet the standard operating temperature for military grade application (-55° to 125° C / -67° to 257° F), which is required to endure greater environmental variability. Operate the product appropriately and only for applications that meet the operating temperature range requirements of that grade.
- 

This document was developed following the process, content and structure defined in ASTM Specification F2908.

## Legend

 Important

 Hints and Tips

 Reference

## Read Before Use

DJI™ provides users with tutorial videos and the following documents:

1. *Safety Guidelines*
2. *Quick Installation Guide*
3. *Installation and Setup Manual*
4. *User Manual*

It is recommended to watch all tutorial videos and read the Safety Guidelines before using for the first time. Prepare for dock installation and first flight by reviewing the Quick Installation Guide. Refer to the Installation and Setup Manual and this User Manual for more information.

- 
-  • The dock must be installed and set up by an authorized service provider. Unauthorized installation and setup may lead to safety risks. Contact DJI Support for information on authorized service providers.
- 

## Video Tutorials

Go to the address below or scan the QR code to watch the tutorial videos, which demonstrate how to use the product safely:



<https://enterprise.dji.com/dock-3/video>

## Download DJI Enterprise App

Scan the QR code to download the latest version.



- 
- To check the operating system versions supported by the app, visit <https://www.dji.com/downloads/djiapp/dji-enterprise>.
  - The interface and functions of the app may vary as the software version is updated. Actual user experience is based on the software version used.
- 

## Download DJI Assistant 2

Download and install DJI ASSISTANT™ 2 (Enterprise Series) using the link below:

<https://www.dji.com/downloads/software/assistant-dji-2-for-matrice>



# Contents

<b>Using this Manual</b>	<b>3</b>
Legend	3
Read Before Use	3
Video Tutorials	3
Download DJI Enterprise App	4
Download DJI Assistant 2	4
<b>1 General Information and System Description</b>	<b>9</b>
1.1 Aircraft	9
Powering on/off	10
Aircraft Status Indicator	10
Beacon	11
Camera	12
Storing and Exporting Photos and Videos	12
Gimbal Notice	13
Flight Control Surfaces	13
Propulsion System	13
Replacing Propellers	14
Notice	14
Avionics	15
Flight Control and Navigation System	15
Communications Equipment	16
Aircraft RTK	16
Sensing System	17
Vision Assist	19
DJI AirSense	20
Intelligent Flight Battery	22
Notice	22
Inserting/Removing the Battery	22
Checking the Battery Level	23
Warming the Battery	23
Dock Warming	24
IP Rating of the Aircraft	24
1.2 Control Station	25
Dock	25
Electrical Cabinet Panel	26
Electrical Cabinet Indicators	27
Backup Battery	27
Dock Cover	28

Dock Environment Sensors	30
Landing Pad	32
Air Conditioning System	33
Dock Network Connection	33
IP Rating of the Dock	33
DJI FlightHub 2	34
Remote Controller	34
Charging the Battery	36
Button Combinations	36
Operating the Touchscreen	37
Remote Controller LEDs	38
Remote Controller Alert	39
Optimal Transmission Zone	39
DJI Pilot 2 App	40
Homepage	40
Camera View	41
1.3 Command and Control Link (C2 Link)	44
1.4 Ground Operational Area Setup	45
<b>2 Performance and Limitations</b>	<b>46</b>
2.1 Specifications	46
2.2 Prohibited Actions	46
2.3 Center of Gravity Limitations	47
<b>3 Normal Procedures</b>	<b>48</b>
3.1 Airspace and Radio Frequency Environment Requirements	48
3.2 Flight Restrictions	49
GEO (Geospatial Environment Online) System	49
GEO Zones	49
Buffer Zone	50
Custom Flight Area	51
Unlocking GEO Zones	51
Flight Altitude and Distance Limits	52
3.3 Use of Takeoff and Landing Equipment	53
3.4 Distance to Control Station	53
3.5 Installation and Configuration	54
3.6 Flight Test Checklist	55
3.7 Takeoff/Landing	56
Auto Take Off/Landing	56
3.8 Planned and Manual Flight	56
Flight Procedure	56
Flight Route Tasks	57

	Terrain Follow	59
	Live Flight Controls	60
	Vehicle-Mounted Operation	61
	Dual-Drone Rotational Operation	62
3.9	Return to Home	62
	Notice	63
	Advanced RTH	64
	Trigger Method	65
	RTH Procedure	66
	RTH Settings	67
	Dock Landing Detection	69
3.10	System Shutdown	69
3.11	Post-Flight Inspection	69
<b>4</b>	<b>Emergency Procedures</b>	<b>71</b>
4.1	Fire	71
4.2	Loss of C2 Link	71
4.3	Loss of Navigation Systems	72
4.4	Control Station Failures	72
	Loss of Control Signal	72
	DJI FlightHub 2 Failure	72
	Alternate Landing	72
	Remote Controller B	73
	Connecting Controller B	73
	Gaining Control via Controller B	73
	Flight Modes	74
	Emergency Stop Button	75
	Other Failures	75
4.5	Flyaway	76
<b>5</b>	<b>Handling, Servicing and Instructions for Maintenance</b>	<b>77</b>
5.1	Storage	77
	Dock Storage	77
	Aircraft Storage	77
	Battery Storage	78
5.2	Charging the Battery	78
	Charging via the Dock	78
	Charging Mode	79
	Using the Charging Hub	79
	Battery Level LEDs	81
	Battery Protection Mechanisms	81
5.3	Conditioning Batteries	82

5.4	Cleaning and Maintaining	82
<b>6</b>	<b>Appendix</b>	<b>83</b>
6.1	Firmware Update	83
	Using DJI FlightHub 2	83
	Using DJI Assistant 2 (Enterprise Series)	83
	Aircraft and Control Station Firmware Update	83
	Notices	84
6.2	Expansion Port	84
	Installation Requirements	84
	Third-Party Payload Requirements	85
6.3	Using Enhanced Transmission	86
	Inserting the nano-SIM Card	86
	Installing DJI Cellular Dongle 2	87
	Using Enhanced Transmission	87
	Security Strategy	88
	4G Network Requirements	88
6.4	Troubleshooting Procedures	89
6.5	Risks and Warnings	89
6.6	Disposal	90
6.7	C2 and C6 Certification	90
	Remote Controller Warnings	92
	Direct Remote ID	92
	Geo Caging	93
	<b>Braking Distance in CV</b>	96
	Flight Termination System (FTS)	97
	EASA Notice	100
	Original Instructions	100
6.8	FAR Remote ID Compliance Information	100

# 1 General Information and System Description

## 1.1 Aircraft

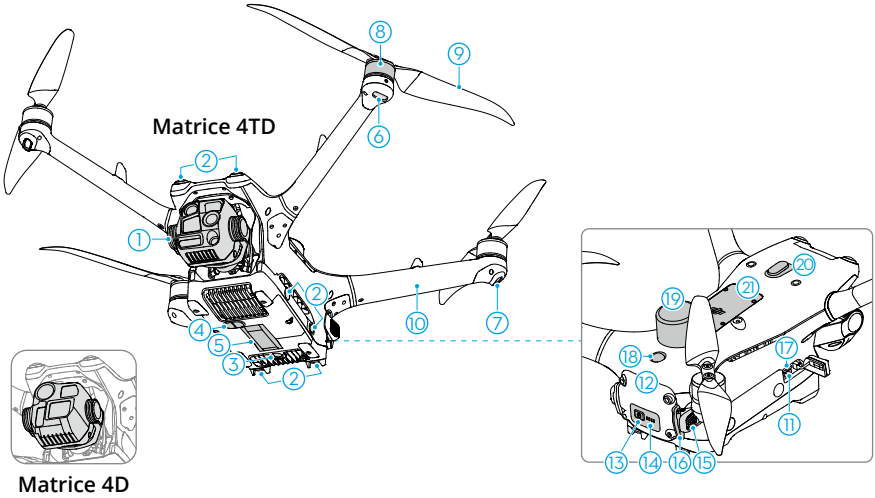

Matrice 4D

- |   |                                 |
|---|---------------------------------|
| 1. Gimbal Camera <sup>[1]</sup>             | 12. Intelligent Flight Battery  |
| 2. Vision System                            | 13. Power Button                |
| 3. Auxiliary Light                          | 14. Battery Level LEDs          |
| 4. Infrared Sensing System                  | 15. Battery Buckle              |
| 5. Internal Charging Modules <sup>[2]</sup> | 16. Battery Locking Arm         |
| 6. Front LEDs                               | 17. microSD Card Slot           |
| 7. Aircraft Status Indicators               | 18. Beacon                      |
| 8. Motors                                   | 19. GNSS/RTK Antenna            |
| 9. Propellers                               | 20. E-Port                      |
| 10. Frame Arms (incl. internal antennas)    | 21. Cellular Dongle Compartment |
| 11. USB-C Assistant Port (E-Port Lite)      |                                 |

[1] DJI Matrice 4D and DJI Matrice 4TD are equipped with different cameras. Refer to the actual product purchased.

[2] DO NOT block the internal charging module.

- ⚠ • Contact DJI or a DJI authorized dealer to replace the components of the product if damaged. DO NOT disassemble the product without the assistance of a DJI authorized dealer (except for components allowed to be disassembled by users in this manual), otherwise it will not be covered under warranty.
- 

## Powering on/off

Power on/off: Press, then press and hold.

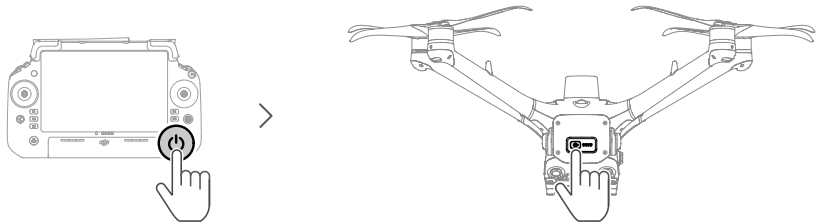

## Aircraft Status Indicator

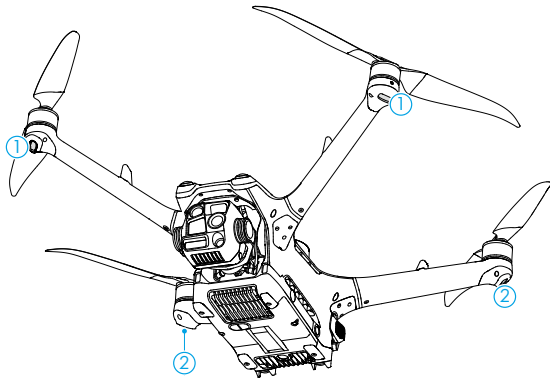

1. Front LED





2. Aircraft Status Indicator

When the aircraft is powered on but the motors are not running, the front LEDs glow solid red to display the orientation of the aircraft.





When the aircraft is powered on, but the motors are not running, the aircraft status indicators will display the current status of the aircraft.

### Aircraft Status Indicators Descriptions

**Normal States**

	Blinks red, yellow, and green alternately	Powering on and performing self-diagnostic tests
	Blinks yellow four times	Warming up
	Blinks green slowly	GNSS enabled
	Blinks green twice repeatedly	Vision systems enabled
	Blinks yellow slowly	GNSS and vision system disabled (ATTI mode enabled)

**Warning States**

	Blinks yellow quickly	Remote controller signal lost
	Blinks red slowly	Takeoff is disabled (e.g., low battery) <sup>[1]</sup>
	Blinks red quickly	Critically low battery
	Solid red	Critical error
	Blinks red and yellow alternately	Compass calibration required

[1] If the aircraft cannot take off while the status indicators are blinking red slowly, view the warning prompt in DJI Pilot 2.

**After the motors start**, the front LEDs blink red and green alternately, and the aircraft status indicators blink green.

- ⚠ • Lighting requirements vary depending on the region. Observe local laws and regulations.
- To obtain better footage, the front LEDs turn off automatically when taking photos and videos if the front LEDs are set to Auto in DJI Pilot 2.

**Beacon**

The beacon on the aircraft enable you to find the aircraft when flying at night. The beacon can be manually turned on or off in DJI FlightHub 2.

- ⚠ • DO NOT look directly at the beacons when they are in use to avoid damaging your eyes.

## Camera

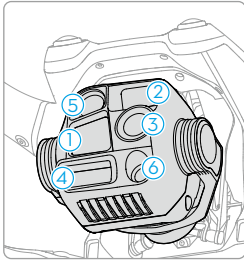

DJI Matrice 4TD

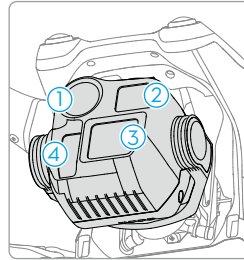

DJI Matrice 4D

- |                       |                            |
|-----------------------|----------------------------|
| 1. Tele camera        | 4. Laser Range Finder      |
| 2. Medium Tele Camera | 5. Infrared Thermal Camera |
| 3. Wide-Angle Camera  | 6. NIR Auxiliary Light     |

- 
-  • Due to the characteristics of the infrared sensor, the infrared sensor may become burnt before sunburn protection is triggered. DO NOT expose the infrared camera lenses to strong sources of energy such as the sun, lava, or a laser beam. Otherwise, the camera sensor may become burnt leading to permanent damage.
- Make sure the temperature and humidity are suitable for the camera during use and storage.
  - Use a lens cleaner to clean the lens to avoid damage or poor image quality.
  - DO NOT block any ventilation holes on the camera as the heat generated may damage the device or cause injury.
- 

## Storing and Exporting Photos and Videos

The aircraft supports the use of a microSD card to store photos and videos. Refer to the Specifications for more information about recommended microSD cards.

- 
-  • Ensure that the SD card slot and the microSD card are clean and free of foreign objects during use.
- DO NOT remove the microSD card from the aircraft when taking photos or videos. Otherwise, the microSD card may be damaged.
  - Check camera settings before use to ensure they are configured correctly.
  - Before shooting important photos or videos, shoot a few images to test whether the camera is operating correctly.
-



## Gimbal Notice

---

- ⚠ • Make sure there are no stickers or objects on the gimbal before taking off. DO NOT tap or knock the gimbal after the aircraft is powered on. Take off the aircraft from open and flat ground to protect the gimbal.
  - Avoid getting dust or sand on the gimbal, especially in the gimbal motors.
  - DO NOT add any extra payload other than an official accessory to the gimbal, as this may cause the gimbal to function abnormally or even lead to permanent motor damage.
  - Precision elements in the gimbal may be damaged by a collision or impact, which may cause the gimbal to function abnormally. Make sure to protect the gimbal from damage.
  - A gimbal motor may enter protection mode if the gimbal is obstructed by other objects or if the gimbal experiences an excessive external force, such as during a collision.
  - Remove the gimbal protector before powering on the device. Attach the gimbal protector when the device is not in use.
  - Flying in heavy fog or clouds may make the gimbal wet, leading to temporary failure. The gimbal will recover full functionality once it is dry.
- 

## Flight Control Surfaces

Not applicable for multicopters.

## Propulsion System

The propulsion system consists of motors, ESCs, and folding propellers, to provide stable and powerful thrust.

## Replacing Propellers

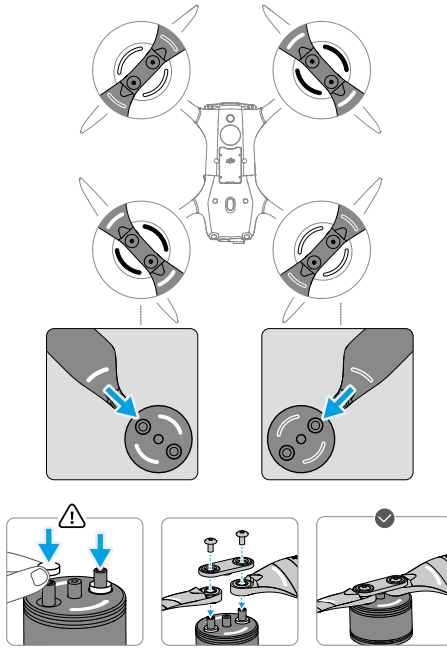

## Notice

---

- ⚠ • The propeller blades are sharp. Handle with care to avoid personal injury or propeller deformation.
- Make sure that the propellers and motors are installed securely before each flight.
- Only use official DJI propellers. DO NOT mix propeller types.
- Propellers are consumable components. Purchase additional propellers if necessary.
- Make sure that all propellers are in good condition before each flight. DO NOT use aged, chipped, or broken propellers. Clean the propellers with a soft, dry cloth if there is any foreign matter attached.
- To avoid injury, stay away from rotating propellers or motors.
- To avoid damaging the propellers, place the aircraft correctly during transportation or storage. DO NOT squeeze or bend the propellers. If propellers are damaged, the flight performance may be affected.

- Make sure that the motors are mounted securely and can rotate smoothly. DO NOT take off if a motor is stuck and unable to rotate freely.
  - DO NOT attempt to modify the structure of the motors.
  - DO NOT touch or let hands or body parts come in contact with the motors after flight, as they may be hot.
  - DO NOT block any of the ventilation holes on the motors or the body of the aircraft.
  - Make sure the ESCs sound normal when powered on.
  - Make sure to only use the screwdriver from the aircraft package for mounting propellers. Using other screwdrivers may damage the screws.
  - Make sure to keep the screws vertical while tightening them. The screws should not be at a tilted angle to the mounting surface. After installation is complete, check whether the screws are flush and rotate the propellers to check for any abnormal resistance.
  - The screwdriver is only for mounting the propellers. DO NOT use the screwdriver to disassemble the aircraft.
  - If a propeller is broken, remove the two propellers and screws on the corresponding motor and discard them. Use two propellers from the same package. DO NOT mix with propellers from other packages.
  - Make sure to use the provided washers and screws when replacing the propellers. DO NOT reuse old washers or screws. Use the screw glue (recommended model: 243) on the screws.
  - DO NOT scratch the propeller surface. DO NOT use solvents containing oil or alcohol when cleaning the propeller blades. Otherwise, the water-resistant coating may be damaged. Replace the propellers after 450 flights for optimal anti-freezing performance.
- 

## Avionics

### Flight Control and Navigation System

The flight control and navigation system built into the aircraft has modules such as the flight controller, IMU, barometer, GNSS receiver, RTK module, and a compass, providing stable and reliable navigation and control. The dedicated industrial flight controller provides multiple operation modes for various applications.

## Communications Equipment

The aircraft boasts DJI O4+ Enterprise system with OcuSync video transmission antennas, offering stable and reliable communication with the control station.

### Aircraft RTK

When the aircraft is used with the RTK module of the dock, centimeter-level positioning data can be obtained, allowing for a precise flight route and landing.

D-RTK 3 Multifunctional Station (sold separately) is also supported. Visit <https://enterprise.dji.com/d-rtk-3/downloads> to view the accessory user guide and learn about how to use the product.

Users can choose different positioning accuracy when making task plans in DJI FlightHub 2:

- RTK: The aircraft will take off and wait for the RTK data to converge before performing a task. It is unable to pause the task during convergence. It is recommended to choose this task when high positioning accuracy is required.
- GNSS: The aircraft will perform a task directly without converging RTK data. It is recommended to choose this task when basic positioning accuracy is acceptable. Make sure that there are no obstacles within 20 meters along the flight route before initiating the task plan.



- The number of searched satellites should be greater than 20 for the aircraft RTK data to converge. If there is strong signal interference or ionospheric scintillation, the aircraft RTK data may not converge.
  - The RTK positioning needs to be done in an environment with a strong GNSS signal (outdoors in an open area without obstacles) to ensure high-precision positioning. The RTK solution is fixed to converge to centimeter-level accuracy.
  - Make sure the dock RTK is calibrated before an RTK task to ensure accurate flight along the flight route.
  - If the aircraft RTK type is switched (for example enabling RTK using the remote controller B then re-link the aircraft and the dock), make sure to restart the aircraft before performing flight tasks.
-

## Sensing System

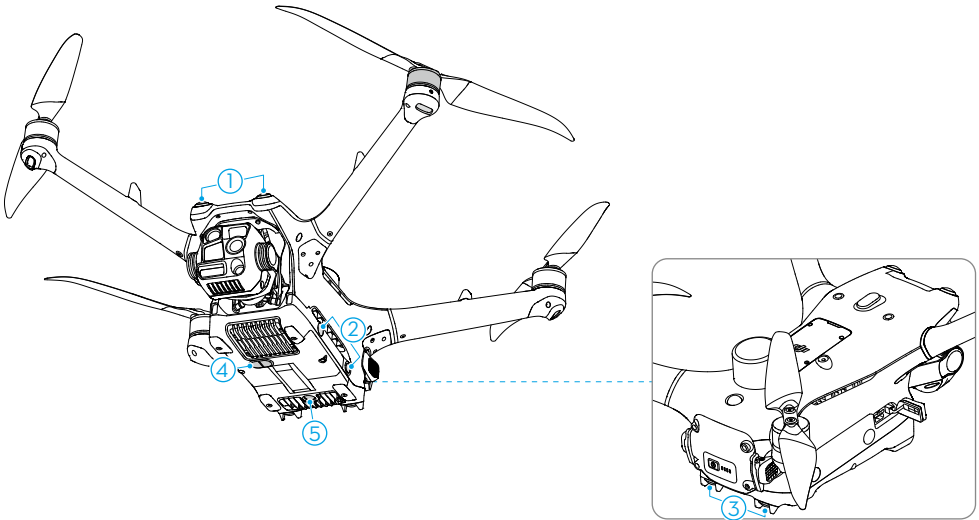

1. Forward and Upward Vision System
2. Lateral Vision System
3. Backward and Downward Vision System
4. Infrared Sensing System
5. Auxiliary Light

The vision system works best with adequate lighting and clearly marked or textured obstacles. The vision system will activate automatically when the aircraft is in Normal mode and Obstacle Sensing is enabled in DJI FlightHub 2 / DJI Pilot 2. The positioning function is applicable when GNSS signals are unavailable or weak.

The auxiliary light located at the bottom of the aircraft can assist the downward vision system. It will automatically turn on by default in low-light environments when the flight altitude is under 5 m after takeoff.

- 💡 • When Vision Positioning and Obstacle Sensing are disabled, the aircraft relies only on GNSS to hover, obstacle sensing is unavailable, and the aircraft will not automatically decelerate during descent close to the ground. Extra caution is required when Vision Positioning and Obstacle Sensing are disabled. Disabling Vision Positioning and Obstacle Sensing takes effect only when flying manually, and will not take effect when using auto modes such as RTH, or auto landing.
- Clean the lenses of the sensing system on a regular basis. If the vision sensor lenses are blurry, a warning will appear. Clean the lenses as soon as possible after the warning appears.

- When flying near environment with complicated obstacles such as near the power distribution network, it is recommended to install the obstacle sensing module for the aircraft.
- 

### Notice

---



- Pay attention to the flight environment. The sensing system only works in certain scenarios and cannot replace human control and judgment. During a flight, always pay attention to the surrounding environment and the warnings in DJI FlightHub 2, and be responsible for and maintain control of the aircraft at all times.
- If there is no GNSS available, the downward vision system will assist with aircraft positioning, and works best when the aircraft is at an altitude from 0.5 m to 30 m. Extra caution is required if the altitude of the aircraft is above 30 m as the vision positioning performance may be affected.
- In low-light environments, the vision system may not achieve optimal positioning performance even if the auxiliary light is turned on. Fly with caution if the GNSS signal is weak in such environments.
- The downward vision system may not work properly when the aircraft is flying near water. It is recommended to maintain flight control at all times, make reasonable judgments based on the surrounding environment, and avoid over-relying on the downward vision system.
- The vision system cannot accurately identify large structures with frames and cables, such as tower cranes, high-voltage transmission towers, high-voltage transmission lines, cable-stayed bridges, and suspension bridges.
- The vision system cannot work properly near surfaces without clear pattern variations or where the lighting is too weak or too strong. The vision system cannot work properly in the following situations:
  - ♦ Flying near monochrome surfaces (e.g., pure black, white, red, or green).
  - ♦ Flying near highly reflective surfaces.
  - ♦ Flying near water or transparent surfaces.
  - ♦ Flying near moving surfaces or objects.
  - ♦ Flying in an area with frequent and drastic lighting changes.
  - ♦ Flying near extremely dark (e.g. indoor dark environments) or extremely bright (e.g. outdoor environments with direct sunlight) surfaces.
  - ♦ Flying near surfaces that strongly reflect or absorb infrared waves (e.g., mirrors).

- Flying near surfaces without clear patterns or textures.
  - Flying near surfaces with repeating identical patterns or textures (e.g., tiles with the same design).
  - Flying near obstacles with small surface areas (e.g., tree branches, and power lines).
  - Keep the sensors clean at all times. DO NOT scratch or tamper with the sensors. DO NOT use the aircraft in dusty or humid environments.
  - Avoid flying when it is rainy, smoggy, or the visibility is lower than 100 m. Pay attention to the app prompts and fly with caution.
  - DO NOT obstruct the sensing system.
  - Check the following each time before use:
    - Make sure there are no stickers or any other obstructions over the glass of the sensing system.
    - Use a soft cloth if there is any dirt, dust, or water on the glass of the sensing system. DO NOT use any cleaning product that contains alcohol.
    - Contact DJI Support if there is any damage to the lenses of the sensing system.
  - The aircraft can fly at any time of the day or night. However, the vision system becomes unavailable when flying the aircraft in low-light environments. Fly with caution.
  - The infrared sensing systems may NOT detect the distance accurately in the following situations:
    - Flying near surfaces that can absorb sound waves (e.g., asphalt road surfaces).
    - Flying near a large area of strong reflectors (e.g., multiple traffic signs placed side by side).
    - Flying near tiny obstacles (e.g., iron wires, cables, tree branches, or leaves).
    - Flying near mirrors or transparent objects (e.g., water or glass).
    - Flying in low-visibility environments (e.g., heavy fog or snow).
- 

## Vision Assist

The vision assist view changes the image on the view from the corresponding vision sensors according to the flight speed direction to help users navigate and observe obstacles during flight.

- ⚠ • When using vision assist, the quality of the video transmission may be lower due to transmission bandwidth limits, or the video transmission resolution of the screen on the remote controller.
  - It is normal for propellers to appear in the vision assist view.
  - Vision assist should be used for reference only. Glass walls and small objects such as tree branches, electric wires, and kite strings cannot be displayed accurately.
  - Vision assist is not available when the aircraft has not taken off or when the video transmission signal is weak.
- 



Tap the arrow to switch between different directions of the vision assist view. Tap and hold to lock the direction. Tap the center of the screen to maximize the vision assist view.

---

- ⚠ • When the direction is not locked in a specific direction, the vision assist view automatically switches to the current flight direction. Tap any other directional arrow to switch the direction of the vision assist view for a while before returning to the view of the current flight direction.
  - When the vision assist direction is locked in a specific direction, tap any other arrow to unlock and switch the vision assist view.
- 

## DJI AirSense

Crewed airplanes or helicopters with Automatic Dependent Surveillance–Broadcast (ADS-B) transmitters can broadcast flight information. The DJI aircraft equipped with DJI AirSense can receive the flight information broadcast from ADS-B transmitters that comply with the 1090ES (RTCA DO-260) or UAT (RTCA DO-282) standard and within a radius range of 10 km. DJI AirSense only issues warning messages under certain circumstances when specific crewed airplanes or helicopters are approaching and are



not able to actively control or take over the DJI aircraft to avoid collisions. DJI AirSense has the following limitations:

1. DJI AirSense can only receive messages broadcast by crewed airplanes or helicopters installed with an ADS-B Out device that is in compliance with the 1090ES or UAT standard. DJI AirSense cannot receive messages from crewed airplanes or helicopters that are not equipped with ADS-B Out devices or equipped with devices that are not functioning properly.
2. DJI AirSense uses satellite and radio signals to receive ADS-B messages. If there is an obstacle between a crewed airplane or helicopter and a DJI aircraft, DJI AirSense may not be able to receive broadcast and issue warning messages.
3. Warning messages may be sent with a delay if DJI AirSense experiences any interference from the surrounding environment. Users need to observe the surrounding environment and fly with caution.
4. Warning messages may not be accurate when the DJI aircraft is unable to obtain its location information.
5. DJI AirSense cannot receive broadcast from crewed airplanes or helicopters, nor send warning messages to DJI FlightHub 2 users when DJI AirSense is disabled or not properly functioning.

DJI FlightHub 2 collects all the DJI AirSense data reported by the dock aircraft in the project and displays the location of an approaching crewed airplane or helicopter, as well as a warning message on the web page when there is a potential risk of collision. DJI AirSense can obtain and analyze the location, altitude, orientation, and velocity of the crewed airplane or helicopter and compare the information with the current location, altitude, orientation, and velocity of the dock aircraft to evaluate the collision risk in real time.

- **Warning (high collision risk):** A red airplane icon will appear on the map, and the web page will display the message stating, "Crewed aircraft nearby. Take over aircraft promptly to avoid". DJI FlightHub 2 users can click the dock name to open the device status window and obtain control of the aircraft to avoid collisions.
- **Caution (medium collision risk):** A yellow airplane icon will appear on the map when a crewed airplane or helicopter is relatively near the dock aircraft.
- **Normal (low collision risk):** A blue airplane icon will appear on the map when the crewed airplane or helicopter is relatively far away from the dock aircraft.



- Users can click  in the lower right corner of the map to decide whether to display the low and medium collision risk warnings on the map.
-

## Intelligent Flight Battery

### Notice

---

 • Refer to the Safety Guidelines and the stickers on the battery before use. Users shall take full responsibility for all operation and usage.

---

1. DO NOT charge an Intelligent Flight Battery immediately after flight as it may be too hot. Wait for the battery to cool down to the allowable charging temperature before charging again.
2. To prevent damage, the battery only charges when the battery temperature is within the allowable charging temperature. The ideal charging temperature is from 22° to 28° C (71.6° to 82.4° F). Charging at the ideal temperature range can prolong battery life.
3. A fully charged battery will automatically discharge when it is idle for a period of time. Note that it is normal for the battery to emit heat during the discharging process.
4. Fully charge the battery at least once every three months to maintain battery health. If the battery is not used for an extended period, battery performance may be affected or may even cause permanent battery damage. If a battery has not been charged or discharged for three months or more, the battery will no longer be covered by the warranty.
5. For safety purposes, keep the batteries at a low power level in transit. Before transportation, it is recommended to discharge the batteries to 30% or lower.
6. Over-discharge protection is enabled and discharging stops automatically to prevent over-discharge when the aircraft is idle. Charge the battery to wake it from over-discharge protection before using again. Over-discharge protection is not enabled during flight.

### Inserting/Removing the Battery

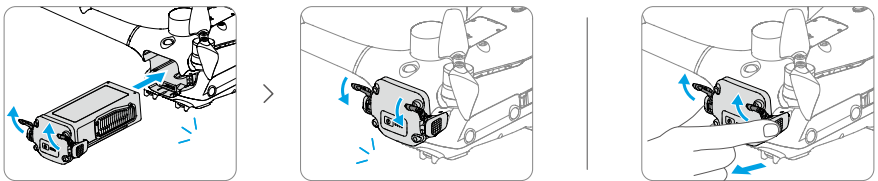

---

 • DO NOT insert or remove the battery while the aircraft is powered on.



---









- Ensure the battery is inserted with a clicking sound. DO NOT launch the aircraft when the battery is not securely mounted, as this may cause poor contact between the battery and the aircraft and present hazards.

## Checking the Battery Level

Press the power button once to check the current battery level.



The battery level LEDs display the power level of the battery during charging and discharging. The statuses of the LEDs are defined below:

-  LED is on
-  LED is flashing
-  LED is off

Blinking Pattern	Battery Level
	92-100%
	76-91%
	63-75%
	51-62%
	38-50%
	26-37%
	13-25%
	0-12%

## Using DJI FlightHub 2

There are two ways to check the battery information in DJI FlightHub 2.

- Open the Project page, click  >  to view the battery level and battery status.
- Open the Devices page, click **Dock** >  to view the battery level and battery temperature, battery cycles and other information.

## Warming the Battery

The battery has a self-heating feature to be used when operating in low-temperature conditions:

- If the battery is inserted into the aircraft and powered on, self-heating will start automatically when the battery temperature is low. The aircraft will take off after the battery is warmed up.
- If the battery is not inserted into the aircraft, press and hold the power button on the battery to activate self-heating. Press and hold the power button again to stop self-heating.
- When the battery is **Warming Up (1)** and **Keeping Warm (2)**, the battery level LEDs will blink as follows.

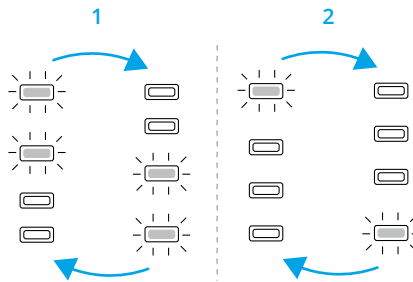

## Dock Warming

If the aircraft is powered off in low-temperature environments, the dock will constantly provide a power supply for the battery to keep warm, so that the aircraft can take off at any time in cold environments. After the battery charging is completed, if the aircraft is in the idle status, the battery will keep warm at a temperature above 10° C (50° F).

The battery will stop keeping itself warm when the user initiates an Immediate flight task, powers on the aircraft, or starts battery charging.

## IP Rating of the Aircraft

1. Under stable laboratory conditions, the DJI Matrice 4D Series aircraft achieves an IP55 protection rating of IEC 60529 standards when equipped with the Intelligent Flight Battery. The protection rating is not permanent and may lower over an extended period.
  - DO NOT fly when the amount of rainfall exceeds 100 mm/24 h.
  - Make sure the battery surfaces, battery ports, and the battery compartment ports and surfaces are dry before inserting the battery.
  - The product warranty does not cover water damage.
2. The aircraft does not achieve an IP55 protection rating in the following circumstances:

- Batteries other than the official battery are used.
  - The battery is not firmly installed.
  - The covers for the expansion ports are not firmly closed if not used.
  - The cellular dongle compartment or external devices such as the speaker or the spotlight are not firmly installed or the screws are not tightened.
  - The aircraft shell is cracked or the water-resistant adhesive is aged or damaged.
3. The body surface may become discolored after long-term use. However, such color change does not affect the performance and IP rating of the device.

## 1.2 Control Station

### Dock

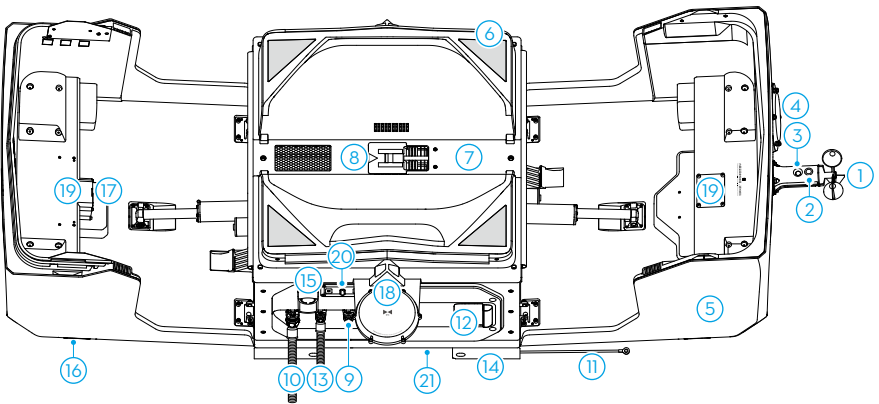

- |                           |   |
|---------------------------|---|
| 1. Wind Speed Gauge       | 8. Aircraft Orientation Marker <sup>[1]</sup> |
| 2. Dock Camera            | 9. PoE Output Port                            |
| 3. Camera Auxiliary Light | 10. AC-IN Port                                |
| 4. Rainfall Gauge         | 11. Earth Wire                                |
| 5. Dock Cover             | 12. Electrical Cabinet                        |
| 6. Positioning Markers    | 13. LAN-IN Port                               |
| 7. Landing Pad            | 14. Mounting Base Brackets                    |

- 15. Emergency Stop Button [2]
- 16. Status Indicators
- 17. Cellular Dongle Compartment
- 18. RTK Module
- 19. For Vehicle-mounted Gimbal Mount
- 20. E-Port
- 21. Drain Pipe Hole (located underneath the dock)

[1] The dock comes with a built-in charging module. Make sure that the landing pad surface is clear of any metal objects in order to avoid high temperatures that may damage the landing pad.

[2] The dock cover will fail to open or close if the emergency stop button is pressed.

## Electrical Cabinet Panel

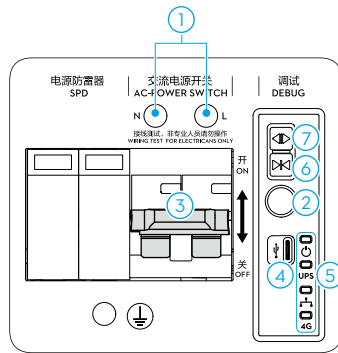

### 1. Wire Testing Terminals

Connect to a multimeter to test the voltage when configuring the dock.

### 2. Multifunctional Button

Press and hold: The dock enters the linking mode.

Press once, then press and hold: Power on/off the backup battery.

### 3. AC Power Switch

Power on/off the dock.

### 4. USB-C Port

Connect to a computer to access DJI Assistant 2.

Connect to a mobile phone to use DJI Enterprise App.

### 5. Electrical Cabinet Indicators

Indicate the working status of the power supply, the backup battery, the wired network and the wireless network.











### 6. Close Button

Press and hold to close the dock cover.

## 7. Open Button

Press and hold to open the dock cover.

## Electrical Cabinet Indicators

⏻ Power Indicator		
 —	Solid red	AC power supply is normal.
	Off	No AC power supply.
UPS Backup Battery Indicator		
 —	Solid blue	Backup battery is full or is supplying power to the dock.
 .....	Blinks blue slowly	Backup battery is charging.
 .....	Blinks blue quickly	Backup battery has low battery power.
	Off	Backup battery is not installed.
🔌 Wired Network Indicator		
 .....	Blinks green quickly	The Ethernet cable is connected and has data transfer with the dock.
	Off	The Ethernet cable is disconnected.
4G 4G Network Indicator		
 .....	Blinks green quickly	4G network is connected and has data transfer with the dock.
	Off	4G network is disconnected or does not have data transfer with the dock.

## Backup Battery

If the dock is powered off due to an emergency power outage, the backup battery can provide power to the dock so that the aircraft can safely return and land.

- ⚠️ • After a power outage, the dock does not support functions such as aircraft charging and air conditioning. Check and fix the malfunctions as soon as possible to restore power to the dock. Make sure to turn off the backup battery if the power supply cannot be restored for an extended period. Otherwise, the backup battery will be over-discharged.

- When the dock is not in use for an extended period, make sure to maintain the backup battery by charging it. Refer to the Installation and Setup Manual for more information on charging and maintaining the backup battery.
- 



## Dock Cover

---



-  • Make sure the internal video transmission antennas are not blocked by snow, ice, or any foreign objects.
  - Regularly check if the propeller bumpers are in good condition. Replace any worn or damaged parts when necessary.
  - Make sure the emergency stop button is released before opening the dock cover. If the emergency stop button is not released, pull out or rotate clockwise to release the emergency stop button.
  - Make sure that the dock cover surface is clear of heavy objects and the operation range is free of obstructions. Keep a safe distance from the dock cover to avoid injury. Press the emergency stop button if necessary.
  - DO NOT press or place heavy objects on the dock cover after it is opened.
  - The dock cover will be automatically closed when the aircraft battery level is low. Keep a safe distance when the dock cover is closing to avoid injury.
- 

## Opening and Closing the Dock Cover

### Using DJI FlightHub 2

Open the DJI FlightHub 2 Project page, click  >  > **Action**, and enable **Remote Debugging**; or open the Devices page, click **Dock** > , and enable **Remote Debugging** to open or close the dock cover.

If the dock cannot detect the aircraft, check whether the aircraft is on the landing pad by using the dock livestream, and follow the instructions in DJI FlightHub 2. Click **Force Close Dock Cover** if the aircraft is not on the landing pad. Click **Close Dock Cover** if the aircraft is on the landing pad.

-  • When closing the dock cover, the aircraft will automatically power on, and the propellers will slowly rotate to avoid damage to the propellers.
  -  • DO NOT remotely open the dock cover in DJI FlightHub 2 if the dock has no power supply.
  - DO NOT click **Force Close Dock Cover** if the aircraft is on the landing pad. Otherwise, the propellers and the dock cover may be damaged.
-







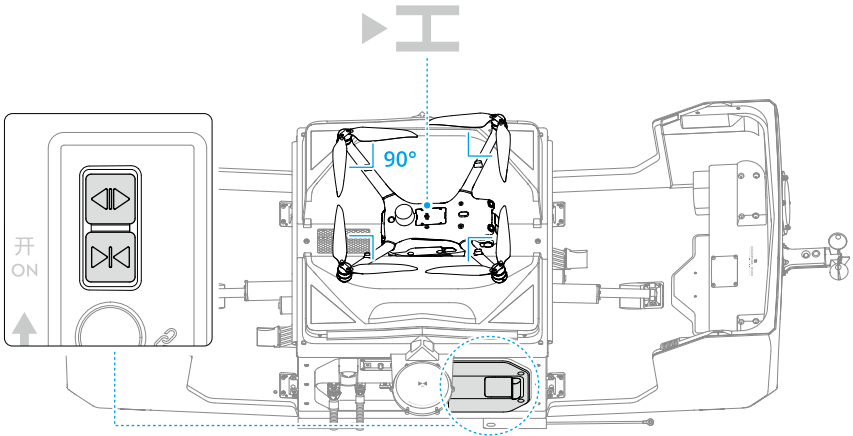

## Using the Open or Close Button

Press and hold the open or close button, and the dock cover will open or close.



- ⚠ • Keep your hands away from the dock cover to avoid injury.
- Before closing the dock cover, make sure to adjust the propeller position as shown in the diagram in order to avoid breaking the propellers when closing the dock cover.

## Dock Cover Status Indicator and Buzzer Alerts

Normal States		
 .....	Blinks white	The dock is working normally and the aircraft is ready to take off.
 .....	Blinks blue	The dock and the aircraft are linking, and the buzzer emits a short beep.
 .....	Blinks green	The aircraft has taken off from the dock and is performing a flight task.
 —	Solid blue	The dock is updating or debugging (including remote debugging and on-site debugging).
Warning States		
 .....	Blinks red	The dock cover is moving or the aircraft is taking off or landing, and the buzzer emits a long beep. <b>⚠ Keep a safe distance from the dock to avoid injury.</b>
 .....	Blinks red and yellow alternately	The emergency stop button on the dock is pressed.

## Dock Environment Sensors

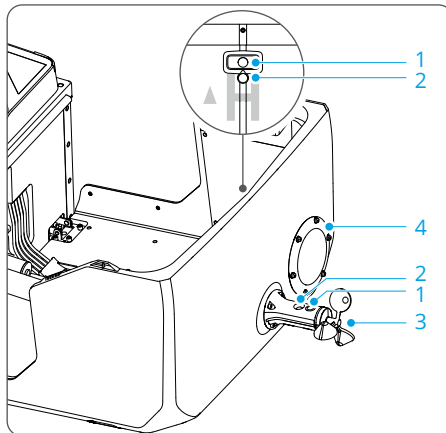

1. Dock Camera: Used to check the real-time dock environment.
2. Camera Auxiliary Light: Automatically turns on at night or in low light, allowing for clearer camera view.

3. Wind Speed Gauge: Used to measure wind speed near the dock. The wind speed gauge features self-heating and is able to work in low-temperature environments. The aircraft cannot take off in high wind speeds.
4. Rainfall Gauge: Used to measure rainfall information near the dock. The rainfall gauge features self-heating and is able to work in low-temperature environments.
5. Environment Temperature Sensor: Located at the dock cover and near the air filter. Used to measure the external temperature. The aircraft cannot take off when the external temperature is below the operating temperature range.
6. Water Immersion Sensor: Used to detect if there is water immersion inside the dock. If a water immersion warning appears in DJI FlightHub 2, contact a qualified electrician to disconnect the dock power supply and remove the water. If the dock works properly, resume the dock power supply. If the dock fails to work properly, make sure to power off the dock and the backup battery, and contact DJI Support.



- The wind speed gauge can only measure the wind speed near the dock, which may be different from the wind speed provided by local meteorological department. If the aircraft ascends to high altitude, the wind speed and direction may change significantly. Fly with caution when the measured wind speed is close to the maximum wind speed resistance of the aircraft.
  - DO NOT press hard on the surface of the rainfall gauge. Otherwise, the sensing module inside may be damaged.
  - Regularly clean the rainfall gauge surface. Replace the rainfall gauge immediately if it is deformed or damaged.
  - If the dock is installed near a vibration source such as near railways, false detection of rainfall may be triggered. Try to keep the dock away from areas with strong vibration sources or strong noise.
-

## Landing Pad

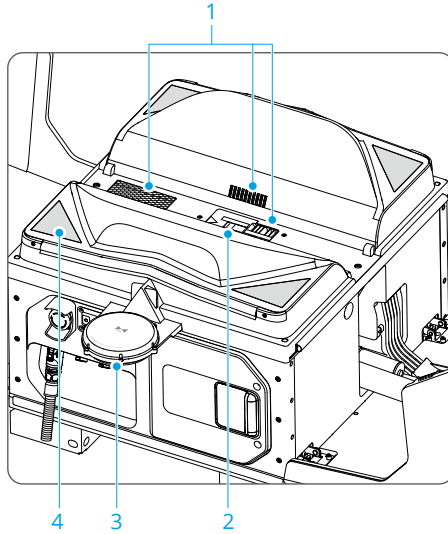



1. Return Vent and Supply Vent: Clean the return vent and the supply vent regularly to remove any dust or debris.
2. Aircraft Orientation Marker: When placing the aircraft on the landing pad, make sure to align the aircraft heading with the aircraft orientation marker. Otherwise, the aircraft may be damaged.
3. RTK module: Make sure the landing pad is clear of obstacles and that the RTK antennas are not covered. Otherwise, the signals will be obstructed and the positioning performance will be affected.
4. Positioning Markers: There are four positioning markers on the landing pad for the aircraft to identify the position of the dock.

- 
- ⚠ • After the dock is powered on, DO NOT place any metal objects such as rings or any electronic devices on the landing pad, or touch the landing pad surface when placing the aircraft on the landing pad to avoid burns.
- The dock cannot charge the aircraft battery if metal foreign objects are detected on the landing pad.
-

## Air Conditioning System

When the dock is in Idle status, the air conditioning system will automatically adjust the temperature inside the dock, providing a suitable environment for the aircraft and the Intelligent Flight Battery.

Users can open the DJI FlightHub 2 Devices page, click **Dock** > , and enable **Remote Debugging** to start heating or cooling.

-  • To ensure the service life of the air conditioning system, a five-minute interval is required when switching between cooling and heating operations. A countdown will appear in DJI FlightHub 2. Wait for the countdown to end before switching operations.

## Dock Network Connection

The dock can be connected to a wired network or 4G network <sup>[1]</sup> for internet access. Users can choose different internet access based on actual needs. When the dock is connected to both a wired network and a 4G network, the wired network will take priority.

[1] 4G network service is not available in some countries or regions. Consult your local DJI-authorized dealer or DJI Support for more information.

-  • Refer to the [“Using Enhanced Transmission”](#) section for more information on how to install the DJI Cellular Dongle 2 and use Enhanced Transmission.

## Data Consumption

Using 4G wireless network for the dock will consume data traffic. The actual data consumption is related to the number, file type, resolution of the transferred media files, and the liveview duration. The following data consumption is used for reference only:

Infrared Photos	Approximately 1 MB per photo
Visible Light Photo (4K)	Approximately 4.5 MB per photo
Visible Light Photo (8K)	Approximately 11 MB per photo
Video (4K)	Approximately 160-450 MB per minute
Video (1080p)	Approximately 63-105 MB per minute

## IP Rating of the Dock

1. Under stable laboratory conditions, DJI Dock 3 achieves an IP56 protection rating by IEC 60529 standards when used with DJI Matrice 4D Series aircraft. The protection

rating is not permanent and may lower over an extended period. Maintain the device on a regular basis.

- The device does not achieve an IP56 protection rating in the following circumstances:
  - The electrical cabinet door is not firmly closed or screws are not tightened.
  - The dock cover is not firmly closed.
  - The covers for the expansion ports are not firmly closed if not used.
  - External modules (such as the wind speed gauge module and the RTK module) are not securely installed.
  - The dock shell is cracked or the water-resistant adhesive is aged or damaged.
- The body surface may become discolored after long-term use. However, such color change does not affect the performance and IP rating of the device.

## DJI FlightHub 2

DJI FlightHub 2 supports task planning, live flight controls, and device management for the dock and aircraft. Create an account and login at <https://fh.dji.com>.

For more details, refer to the DJI FlightHub 2 User Guide which is available on <https://fh.dji.com/user-manual/en/overview.html>.

## Remote Controller

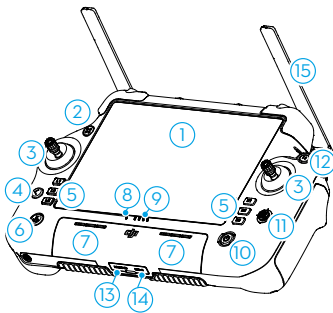

- Touchscreen
- Connection Status LED
- Joystick
- Back/Function Button

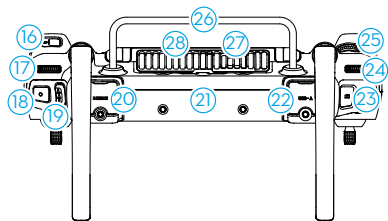

Press once to return to the previous screen. Press twice to return to the home screen.

Use the back button and another button to activate combination buttons. Refer to the [Button](#)

- [Combinations](#) section for more information.
5. L1/L2/L3/R1/R2/R3 Buttons  
Go to camera view in DJI Pilot 2 to view the specific functions of these buttons.
  6. Return to Home (RTH) Button  
Press and hold to initiate RTH. Press again to cancel RTH.
  7. Microphone
  8. Status Indicator
  9. Battery Level LEDs
  10. Power Button  
Press once to check the current battery level. Press once, then press again and hold to power the remote controller on or off. While the remote controller is powered on, press once to turn the touchscreen on or off.
  11. 5D Button
  12. Flight Pause Button  
Press once to make the aircraft brake and hover in place (only when GNSS or Vision Systems are available).
  13. microSD Card Slot
  14. USB-C Port
  15. External Antennas
  16. Customizable C3 Button
  17. Gimbal Dial
  18. Record Button
  19. Flight Mode Switch
  20. HDMI Port
  21. Internal Antennas
  22. USB-A Port  
Users can insert third-party devices, such as a USB flash drive or a memory card.
  23. Focus/Shutter Button  
Press the button halfway down for autofocus and all the way down to take a photo.
  24. Camera Zoom Dial
  25. Customizable C4 Scroll Wheel
  26. Handle
  27. Speaker
  28. Air Vent
  29. Reserved Mounting Holes
  30. Customizable C1/C2 Buttons
  31. Rear Cover
  32. Battery Release Button
  33. Battery Compartment  
For installing the WB37 intelligent battery.
  34. Cellular Dongle Compartment
  35. Rear Cover Release Button
  36. Alarm
  37. Air Intake
  38. M4 Screw Holes

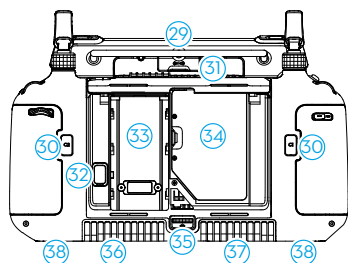

## Charging the Battery

---

- ☀ • Fully discharge and charge the remote controller every three months. The battery depletes when stored for an extended period.
  - ⚠ • It is recommended to use the included USB-C to USB-C cable for optimal charging.
- 

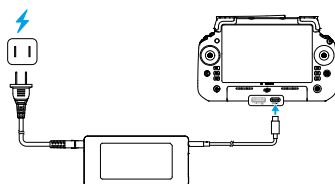

## Checking the Battery Level

Press the power button on the remote controller once to check the internal battery level.

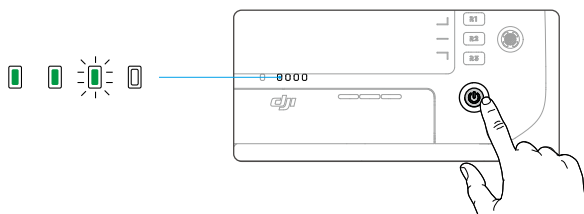

## Button Combinations

Some frequently used features can be activated by using combination buttons. To use combination buttons, press and hold the back button and operate the other button in the combination.



The default button combinations cannot be changed. The following table displays the function of each default button combination.

Combination Operation	Function
Back Button + Left Dial	Adjust Brightness
Back Button + Right Dial	Adjust Volume
Back Button + Record Button	Record Screen
Back Button + Shutter Button	Screenshots
Back Button + 5D Button	Toggle up - Homepage; Toggle down - Shortcut settings; Toggle left - Recently opened apps.

## Operating the Touchscreen

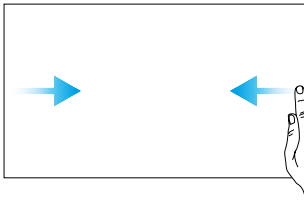

Slide from the left or right to the center of the screen to return to the previous screen.

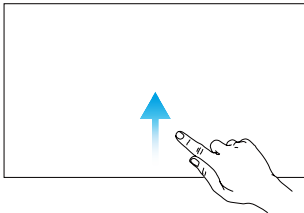

Slide up from the bottom of the screen to return to the homepage.

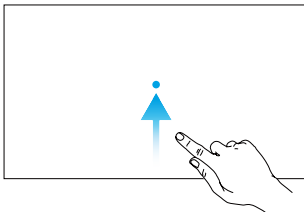

Slide up from the bottom of the screen and hold to access recently opened apps.

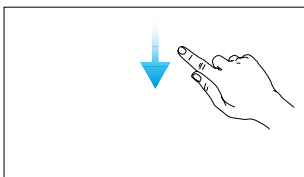



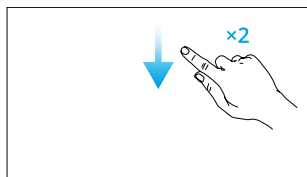





Slide down from the top of the screen to open the status bare when in DJI Pilot 2. The status bar displays information such as time, Wi-Fi signal, and remote controller battery level.



Slide down twice from the top of the screen to open Quick Settings when in DJI Pilot 2. Slide down once from the top of the screen to open Quick Settings when not in DJI Pilot 2.









## Remote Controller LEDs

### Status LED

Blinking Pattern	Descriptions
 — Solid red	Disconnected from the aircraft.
 ..... Blinking red	The battery level of the aircraft is low.
 ..... Solid green	Connected with the aircraft.
 ..... Blinking blue	The remote controller is linking to an aircraft.
 — Solid yellow	Firmware update failed.
 — Solid blue	Firmware update successful.
 ..... Blinking yellow	The battery level of the remote controller is low.
 ..... Blinking cyan	Control sticks not centered.

### Battery Level LEDs

The battery level LEDs indicate the battery level of the remote controller.

Blinking Pattern	Battery Level
	88-100%
	75-87%
	63-74%
	50-62%
	38-49%
	25-37%
	13-24%
	0-12%

## Remote Controller Alert

The remote controller beeps to indicate an error or warning. Pay attention when prompts appear on the touchscreen or in DJI Pilot 2.

Slide down from the top of the screen and select Mute to disable all alerts, or slide the volume bar to 0 to disable some alerts.

The remote controller sounds an alert during RTH, which cannot be cancelled. The remote controller sounds an alert when the battery level of the remote controller is low. A low battery level alert can be cancelled by pressing the power button. When the battery level is critically low, the alert cannot be cancelled.

There will be an alert if the remote controller is not used for a period of time while it is powered on but is not connected to the aircraft. It will automatically power off after the alert stops. Move the control sticks or press any button to cancel the alert.

## Optimal Transmission Zone

Unfold and adjust the antennas. The strength of the remote controller signal is affected by the position of the antennas.

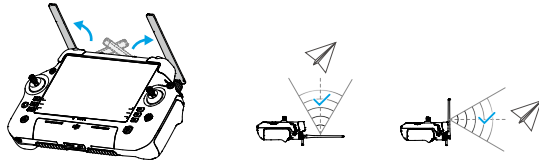

Adjust the direction of the external RC antennas of the remote controller and make sure their flat side is facing the aircraft, so that the controller and aircraft are within the optimal transmission zone.

- ⚠ • DO NOT overstretch the antennas to avoid damage. Contact DJI Support to repair the remote controller if the antennas are damaged. A damaged antenna will greatly decrease the performance of the remote controller and might affect flight safety.
- During flight, DO NOT use other 2.4 GHz or 5.8 GHz communication devices in the same frequency band at the same time, so as not to interfere with the communication signal of the remote controller. For example, avoid enabling mobile phone Wi-Fi.
- A prompt will appear in DJI Pilot 2 if the transmission signal is weak during flight. Adjust the antennas to make sure that the aircraft is in the optimal transmission range.

# DJI Pilot 2 App

## Homepage

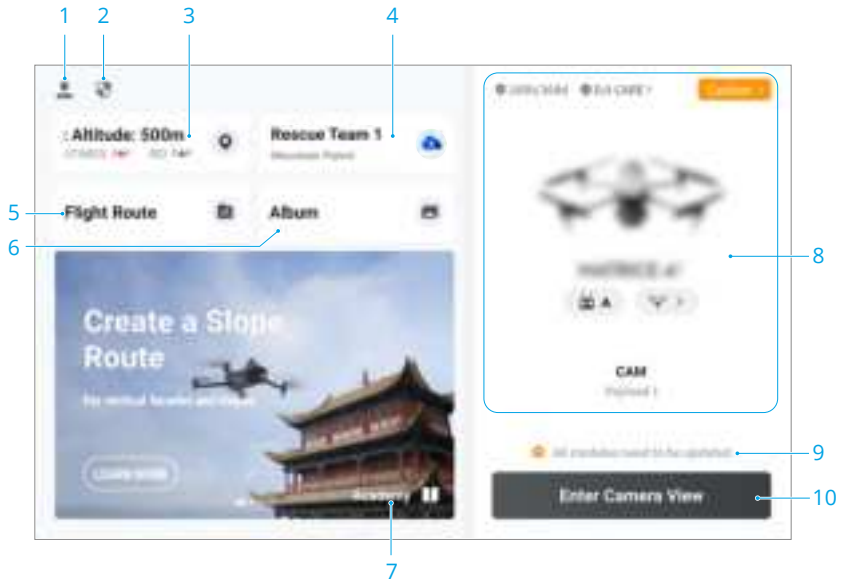

### 1. Profile

Tap to view flight records, download offline maps, manage GEO Zone unlocking, read help documentation, select a language, and more.

### 2. Data and Privacy

Tap to manage network security modes, set security codes, manage app cache, and clear DJI device logs.

### 3. GEO Zone Map

Tap to view whether the current operating area is in a restricted zone or authorization zone, and the current flyable altitude.

### 4. Cloud Service

Tap to view the connection status of the cloud service, select the type of service, or switch from the currently connected service to another cloud service.



- If the DJI account logged in by the user has the DJI FlightHub 2 license, tap the cloud service on the app homepage to automatically log in to DJI FlightHub 2.

Visit the DJI FlightHub 2 page on the DJI official website for more information: <https://www.dji.com/flighthub-2>.

5. **Flight Route**

Tap to enter the flight route library. Users can create and view all flight tasks. Flight tasks can be imported and exported in batches to the remote controller or another external mobile storage device. If DJI FlightHub 2 is connected, you can also view all flight tasks sent from the cloud or upload local tasks to the cloud.

6. **Album**

7. **Academy**

8. **Health Management System**

9. **Firmware Update Shortcut**

- ☰ • A consistent firmware update is required when the firmware versions of some modules of the aircraft are inconsistent with the compatible version of the system.

10. **Enter Camera View**

## Camera View

### Top Bar



1. **Back**

2. **System Status Bar**

If a new alert appears during flight, it will be displayed here and continue flashing. Tap to view the information and stop the flashing.

3. **Flight Status**

Tap to enter the Preflight Check view.

Customize the settings in the preflight checklist, such as RTH Altitude and Out of Control Action, update the Home Point, and set Customize Battery Warning and Obstacle Avoidance settings. The out of control action can be set to RTH, land, hover, or continue.

4. **Battery Level Indicator Bar**

Displays the battery level and the remaining flight time of the Intelligent Flight Battery after takeoff.

5. **GNSS Positioning Status**

Displays the number of searched satellites. When the RTK service is not enabled, the RTK icon is gray. When the RTK data is converged, the RTK icon will turn white. Tap the GNSS positioning status icon to view the RTK mode and GNSS positioning information.

6. **Signal Strength**

7. **Intelligent Flight Battery Level**

Displays the battery level of the aircraft. Tap to view battery level, voltage, and temperature.

8. **Settings**

Tap to expand the settings menu to set the parameters of each module.

**Navigation Display**

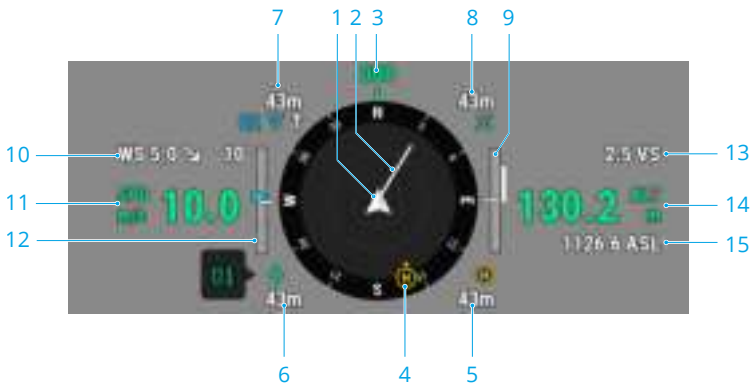

1. **Aircraft**

2. **Aircraft Horizontal Speed Vector**

The white line drawn by the aircraft indicates the flight direction and speed of the aircraft.

3. **Aircraft Orientation**

Displays the current orientation of the aircraft, with 0 degrees as North on the compass.

#### 4. Home Point and Remote Controller Orientations

- Displays the position of the Home Point (yellow H) and the remote controller (blue dot) relative to the aircraft.
- If the remote controller and the Home Point are close to each other, only the Home Point will be displayed.
- The remote controller dot features an arrow to indicate the orientation. If the signal is weak during flight, adjust the remote controller's direction so that the arrow points towards the aircraft.

#### 5. Home Point Distance

Displays the horizontal distance between the Home Point and the aircraft.

#### 6. PinPoint Information

Displays the name of the PinPoint and the horizontal distance from the aircraft to the PinPoint, when PinPoint is enabled.

#### 7. Waypoint Information

Displays the name of the waypoints, the horizontal distance from the aircraft to the waypoint, and the ascending or descending trajectory of the flight route, during a flight route.

#### 8. RNG Target Point Information

Displays the horizontal distance from the aircraft to the target point, when the RNG laser rangefinder is enabled.

#### 9. Vertical Obstacle Sensing Information

Once an obstacle is detected in the vertical direction, an obstacle bar icon will appear. When the aircraft reaches the warning distance, the icon will glow red and orange, and the remote controller will emit long beeping sounds. When the aircraft reaches the obstacle braking distance, the icon will glow red, and the remote controller will emit short beeping sounds. Both the obstacle braking distance and the warning distance can be set in DJI Pilot 2. Follow the prompted instructions in the app to set them. The white line shows the position of the aircraft in three seconds. The higher the vertical speed, the longer the white line.

##### Horizontal Obstacle Sensing Information

The light areas are the obstacle sensing areas of the aircraft, while the dark areas are the blind spots. During flight, keep the aircraft speed vector line out of the obstacle-sensing blind spots.



- If an obstacle is detected, it will be indicated by a green frame when it is outside the warning distance. When the obstacle reaches the warning distance, the frame turns orange. When the obstacle approaches the obstacle braking distance, the frame turns red.
- When the obstacle sensing is disabled, OFF will be displayed. When obstacle sensing is enabled, the vision system is not working but infrared sensing system is available, TOF will be displayed. When the obstacle sensing is enabled, but the vision system and the infrared sensing system are not available, NA will be displayed.

#### 10. Wind Speed and Direction

The wind direction is relative to the aircraft.

#### 11. Aircraft Horizontal Speed

#### 12. Gimbal Tilt

#### 13. Aircraft Vertical Speed

#### 14. Relative Altitude (ALT)

Displays the altitude of the aircraft relative to the takeoff point.

#### 15. Altitude (ASL)

## 1.3 Command and Control Link (C2 Link)

The command and control (C2) link between the aircraft and control station is established using DJI O4+ Enterprise technology with the OcuSync video transmission antennas and DJI O4+ Enterprise system, offering stable and reliable communication. The C2 link provides the control signal from the control station to the aircraft, facilitating real-time operations.

During a flight task, the video transmission signal strength will be displayed in DJI FlightHub 2:

: The transmission signal is strong.

: The transmission signal is medium.



: The transmission signal is weak. There will be a voice prompt to alert users: Image transmission signal weak, fly with caution.

: The transmission signal is disconnected. There will be a voice prompt to alert users: Image transmission signal weak.

## 1.4 Ground Operational Area Setup

The aircraft will take off from and land at the dock. Make sure to install a protective fence to ensure the safety of pedestrians and prevent theft of the product so that unauthorized personnel or animals cannot enter the area where the dock is installed. Refer to the *Installation and Setup Manual* for more information on the protective fence.

## 2 Performance and Limitations

### 2.1 Specifications

Visit the following website for specifications.

<https://enterprise.dji.com/dock-3/specs>

### 2.2 Prohibited Actions

The following actions are prohibited:

- DO NOT operate in the vicinity of crewed aircraft. DO NOT interfere with the operations of crewed aircraft. Be alert and make sure there is no other aircraft in the operation area.
- DO NOT fly the aircraft in venues of major events, including but not limited to sporting events and concerts.
- DO NOT fly the aircraft without authorization in areas prohibited by local laws. Prohibited areas include airports, national borders, major cities and densely populated areas, venues of major events, areas where emergencies have occurred (such as forest fires), and locations with sensitive structures (such as nuclear power plants, power stations, hydropower plants, correctional facilities, heavily traveled roads, government facilities, and military zones).
- DO NOT fly the aircraft above the authorized altitude. DO NOT use the aircraft to carry illegal or dangerous goods or payloads.
- Make sure you understand the nature of your flight operation (such as for recreation, public, or commercial use) and have obtained corresponding approval and clearance from the related government agencies before flight. Consult with your local regulators for comprehensive definitions and specific requirements. Note that remotely-controlled aircraft may be banned from conducting commercial activities in certain countries and regions. Check and follow all local laws and ordinances before flying, as those rules may differ from those stated here.
- Respect the privacy of others when using the camera. DO NOT conduct surveillance operations, such as image capture or video recording on any person, entity, event, performance, exhibition, or property without authorization or where there is an expectation of privacy, even if the image or video is captured for personal use.
- Be advised that in certain areas, the recording of images and videos from events, performances, exhibitions, or commercial properties by means of a camera may contravene copyright or other legal rights, even if the image or video was shot for personal use.

- DO NOT use this product for any illegal or inappropriate purpose, such as spying, military operations, or unauthorized investigations. DO NOT trespass onto the private property of others. DO NOT use this product to defame, abuse, harass, stalk, threaten, or otherwise violate the legal rights of others, such as privacy and publicity rights.



- Read the Safety Guidelines for more prohibited actions before first time use.
- 

## 2.3 Center of Gravity Limitations

The original aircraft center of gravity has been adjusted before delivery.

The aircraft is equipped with an E-Port and E-Port Lite for connecting third-party payloads. If any third-party payloads are installed on the aircraft, make sure to adjust the aircraft center of gravity as per the guidelines and requirements. Visit <https://developer.dji.com> for more information.

## 3 Normal Procedures

### 3.1 Airspace and Radio Frequency Environment Requirements

1. DO NOT operate the aircraft in severe weather conditions, including wind speeds exceeding 12 m/s, snow, moderate rain, and fog.
2. Only fly in open areas. Tall buildings and large metal structures may affect the accuracy of the onboard compass and GNSS system.
3. Fly the aircraft within visual line of sight (VLOS). Avoid mountains and trees blocking GNSS signals. Any flight beyond visual line of sight (BVLOS) can be conducted only when the aircraft performance, the knowledge and skills of the pilot, and the operational safety management are compliant with local regulations for BVLOS. Avoid obstacles, crowds, trees, and bodies of water. For safety reasons, DO NOT fly the aircraft near airports, highways, railway stations, railway lines, city centers, or other sensitive areas, unless any permit or approval is obtained under local regulations.
4. Make sure the beacon and the auxiliary bottom light are enabled at night for flight safety.
5. The performance of the aircraft and its battery is limited when flying at high altitudes. Fly with caution. DO NOT fly above the specified altitude.
6. The braking distance of the aircraft is affected by the flight altitude. The higher the altitude, the greater the braking distance. When flying at high altitudes, you should reserve adequate braking distance to ensure flight safety.
7. GNSS cannot be used on the aircraft in polar regions. Use the vision system instead.
8. DO NOT take off from moving objects such as cars, ships, and airplanes.
9. Be careful when taking off in the desert or from a beach to avoid sand entering the aircraft.
10. DO NOT operate the aircraft near bird flocks.
11. Avoid interference between the control station and other wireless equipment. It is recommended to power off nearby Wi-Fi and Bluetooth devices.
12. Be extremely alert when flying near areas with magnetic or radio interference. Pay close attention to the video transmission quality and signal strength. Return to the Home Point and land the aircraft if prompted to do so to ensure flight safety. Sources of electromagnetic interference include but are not limited to: high voltage lines, large-scale power transmission stations, radar stations, mobile base stations, and broadcasting towers. Strong electromagnetic or electric field interference may cause damage to the aircraft or even crashing.

13. Make sure to set an alternate landing site before flight. The aircraft will fly to the alternate landing site when the dock is not suitable for landing.
14. DO NOT use the aircraft or the dock in an environment at risk of a fire or explosion.
15. Operate the dock and the aircraft only for applications in the operating temperature range. In low-temperature environments, it is necessary to check via the dock camera livestream for the following: snow and ice on the dock cover or the aircraft, frozen propellers. Return to home and land the aircraft as soon as possible if a motor overload warning prompt appears.

## 3.2 Flight Restrictions

### GEO (Geospatial Environment Online) System

The DJI Geospatial Environment Online (GEO) System is a global information system that provides real-time information on flight safety and restriction updates and prevents UAVs from flying in restricted airspace. Under exceptional circumstances, restricted areas can be unlocked to allow flights. Prior to that, you must submit an unlocking request based on the current restriction level in the intended flight area. The GEO system may not fully align with local laws and regulations. You are responsible for your own flight safety and must consult with the local authorities on the relevant legal and regulatory requirements before requesting to unlock a restricted area. For more information about the GEO system, visit <https://fly-safe.dji.com>.

### GEO Zones

The DJI GEO system designates safe flight locations, provides risk levels and safety notices for individual flights, and offers information on restricted airspace. All restricted flight areas are referred to as GEO Zones, which are further divided into Restricted Zones, Authorization Zones, Warning Zones, Enhanced Warning Zones, and Altitude Zones. You can view such information in real-time in DJI FlightHub 2. GEO Zones are specific flight areas, including but not limited to airports, large event venues, locations where public emergencies have occurred (such as forest fires), nuclear power plants, prisons, government properties, and military facilities. By default, the GEO system limits takeoffs and flights in zones that may cause safety or security concerns. A GEO Zone map that contains comprehensive information on GEO Zones around the globe is available on the official DJI website: <https://fly-safe.dji.com/nfz/nfz-query>.

## Buffer Zone

### Buffer Zones for Restricted Zones/Authorization Zones

To prevent the aircraft from accidentally flying into a Restricted or Authorization Zone, the GEO system creates a buffer zone of about 20 meters wide outside each Restricted and Authorization Zone. As shown in the illustration below, the aircraft can only take off and land in place or fly toward an opposite direction of the Restricted or Authorization Zone when inside the buffer zone, and cannot fly toward the Restricted or Authorization Zone unless an unlocking request has been approved. The aircraft cannot fly back into the buffer zone after leaving the buffer zone.

### Buffer Zones for Altitude Zones

A buffer zone of about 20 meters wide is established outside each Altitude Zone. As shown in the illustration below, when approaching the buffer zone of an Altitude Zone in a horizontal direction, the aircraft will gradually reduce its flight speed and hover outside the buffer zone. When approaching the buffer zone from underneath in a vertical direction, the aircraft can ascend and descend in altitude or fly in an opposite direction of the Altitude Zone, but cannot fly toward the Altitude Zone. The aircraft cannot fly back into the buffer zone in a horizontal direction after leaving the buffer zone.

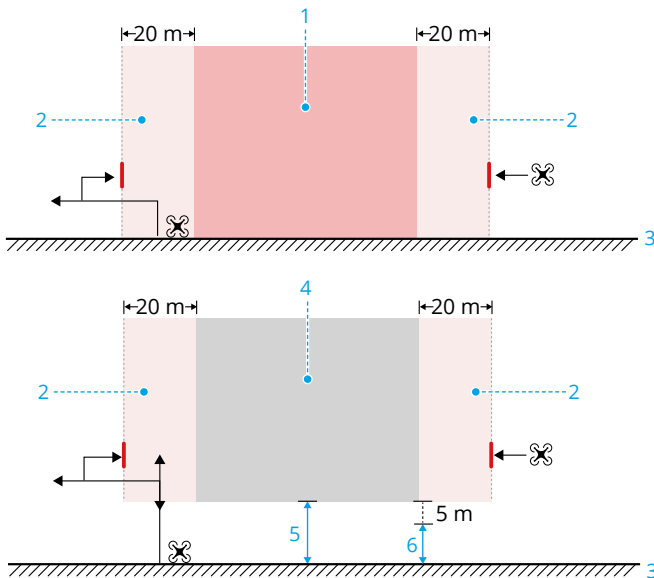

- |                                    |                    |
|------------------------------------|--------------------|
| 1. Restricted Zone/Authorized Zone | 4. Altitude Zone   |
| 2. Buffer Zone                     | 5. Altitude Limit  |
| 3. Ground                          | 6. Flight Altitude |

## Custom Flight Area

Users can click  to enter Map Task Area and set the Custom Flight Area in DJI FlightHub 2.

The types of the custom flight areas include:

- **Custom Task Area:** The aircraft can perform tasks within this area.
- **Custom GEO Zone:** The aircraft cannot fly into this area. When the aircraft approaches the boundary of a GEO Zone, the aircraft will automatically decelerate and hover, and will trigger RTH after hovering for 30s.
- **Custom No-Landing Zone:** The aircraft cannot automatically land within this area.

Visit <https://fh.dji.com/user-manual/en/overview.html> for more information.

- 
-  • During a flight task, if landing is triggered within the Custom No-Landing Zone, the aircraft will automatically plan the shortest path to leave the zone before landing. If the aircraft encounters a GEO Zone or an obstacle, or if landing is cancelled, it will stop the leaving process. In this case, manually take control and fly the aircraft out of the No-Landing Zone and then land the aircraft. Otherwise, the aircraft will land directly.
- If forced landing within the No-Landing Zone is needed, make sure to check the landing environment and ensure safety before landing.
- 

## Unlocking GEO Zones

**Self-Unlocking** is intended for unlocking Authorization Zones. To complete Self-Unlocking, you must submit an unlocking request via the DJI FlySafe website at <https://fly-safe.dji.com>. Once the unlocking request is approved, you can synchronize the unlocking license through DJI FlightHub 2: click **Device Management > Dock >  > Remote Debugging > Dock Control**, and set the unlocking license.

**Custom Unlocking** is tailored for users with special requirements. It designates user-defined custom flight areas and provides flight permission documents specific to the needs of different users. This unlocking option is available in all countries and regions and can be requested via the DJI Fly Safe website at <https://fly-safe.dji.com>.

- 
-  • To ensure flight safety, the aircraft will not be able to fly out of the unlocked zone after entering it. If the Home Point is outside the unlocked zone, the aircraft will not be able to return home.
- Make sure to re-import the unlocking license when using a new aircraft.
-

## Flight Altitude and Distance Limits

Max altitude restricts an aircraft's flight altitude, while max distance restricts an aircraft's flight radius around the Home Point. These limits can be changed in the DJI FlightHub 2 for improved flight safety.

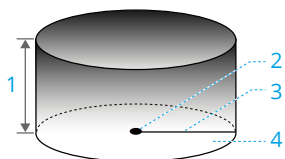

1. Max Altitude
2. Home Point (Horizontal Position)
3. Max Distance
4. Height of aircraft when taking off

### Strong GNSS Signal

	Flight Restrictions	Prompt
Max Altitude	Altitude of the aircraft cannot exceed the value set.	Max flight altitude reached.
Max Distance	The straight-line distance from the aircraft to the Home Point cannot exceed the max flight distance set.	Max flight distance reached.

### Weak GNSS Signal

	Flight Restrictions	Prompt
Max Altitude	<ul style="list-style-type: none"> <li>• Altitude is restricted to 60 m from the takeoff point if lighting is sufficient.</li> <li>• Altitude is restricted to 3 m above the ground if lighting is not sufficient and the 3D infrared sensing system is functioning.</li> <li>• Altitude is restricted to 60 m from the takeoff point if lighting is not sufficient and the 3D infrared sensing system is not functioning.</li> </ul>	Max flight altitude reached.
Max Distance	No limits	

**⚠** • If the aircraft flies out of the set flight range due to inertia, you can still control the aircraft but cannot fly it any further away.



- When the aircraft is used with the dock to perform a flight route task, it cannot take off if there is no GNSS signal. If the GNSS signal becomes weak during flight, the flight route task will be interrupted and RTH will be triggered.

### 3.3 Use of Takeoff and Landing Equipment

The dock can accommodate one aircraft, from where it can take off and land. The dock can also charge the aircraft battery and provide a suitable environment for aircraft storage.

### 3.4 Distance to Control Station

When the user performs automated operations remotely using DJI FlightHub 2, the aircraft will take off from and land at the dock. Make sure to install a protective fence to ensure the safety of pedestrians and prevent theft of the product so that unauthorized personnel or animals cannot enter the area where the dock is installed. Make sure that no flight plan is performed on DJI FlightHub 2 and that the aircraft has landed inside the dock before entering the protective fence when operating the dock on site. After entering the area, make sure to press the emergency stop button of the dock.

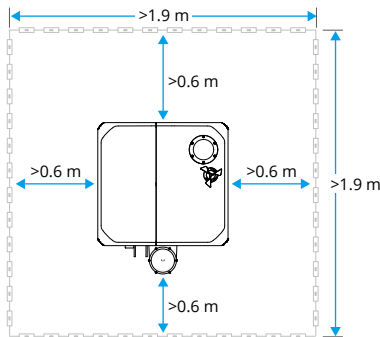

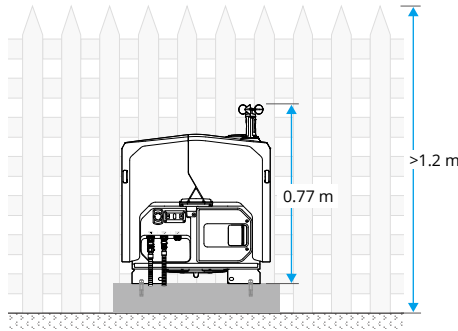

During a flight task, the aircraft should be more than 10 m away from users to ensure safety.

If it is necessary to take off and land the aircraft using the remote controller, the aircraft should be more than 10 m away from operator to ensure safety.

### 3.5 Installation and Configuration

The dock needs to be installed by a DJI-authorized service provider with the aircraft prepared on site. Refer to the Installation and Setup Manual for more information on installation, aircraft preparation, linking, and activation.

To ensure that the dock and aircraft are properly functioning, an on-site flight test of automatic operation should be performed in DJI FlightHub 2 after completing the dock configuration.

- ⚠ • Make sure to install the gimbal protector for the aircraft before transportation.
- Make sure to contact a DJI authorized service provider for installation. There may be potential safety hazards if the product is installed by the user. Contact DJI Support for information on authorized service providers.
- Make sure the dock RTK is calibrated before a flight task to ensure accurate flight along the flight route. The dock RTK data is already calibrated using the remote controller during dock configuration, and does not require recalibration if the dock location remains the same.
- When setting the alternate landing site or performing RTK tasks, DO NOT move the dock position, restart the dock, or recalibrate the dock position.
- Increased ionospheric activity or scintillation may affect the accuracy of RTK positioning. In this case, it is not recommended to calibrate the dock position.

- Make sure to calibrate the aircraft compass before using for the first time or after installing a payload. Otherwise, the aircraft positioning accuracy may be adversely affected.

## 3.6 Flight Test Checklist

After creating or modifying a flight route, it is recommended to conduct an on-site flight test. Pay attention to the video transmission on the screen during flight tests. Make sure that the dock and the aircraft can operate normally before performing any flight tasks.

1. Make sure to follow the checklist before leaving in the Quick Installation Guide to complete the on-site check.
2. Check the following in DJI FlightHub 2 before a flight task:
  - a. All the device firmware (the dock, aircraft, and accessories) has been updated to the latest version.
  - b. There are no abnormal prompts for the dock and aircraft in the DJI FlightHub 2.
  - c. The wind speed, external temperature, and rainfall are suitable for a flight task, and that the dock network connection is stable.
  - d. The aircraft has enough battery power, and the GNSS signal is strong.
  - e. The dock RTK is calibrated and converged, and the alternate landing site and the alternate landing altitude is set.
  - f. The obstacle sensing of the aircraft is enabled.
  - g. Set the Max Altitude and the Max Distance based on actual needs. Make sure to set the RTH altitude at least 5 meters below the altitude limit. There are no obstacles during the flight and RTH.
  - h. Pay attention to the battery level during the flight. DO NOT cancel RTH when low battery occurs.
3. Divide the airspace for flight when multiple aircraft are operating simultaneously in order to avoid collisions during flight.



- It is recommended to link the remote controller as controller B before flight tests for safety reasons.
- To ensure flight precision, when importing flight routes to DJI FlightHub 2, make sure the RTK signal source of the flight route is the same as the signal source used to calibrate the dock RTK. Otherwise, the actual flight trajectory of the aircraft differs from the preset flight route, and may even cause the aircraft to crash.

## 3.7 Takeoff/Landing

### Auto Take Off/Landing

The aircraft automatically takes off and lands when it is operate with the dock. Quick Takeoff can be achieved in DJI FlightHub 2:

- Click **Virtual Cockpit** in the device status window and the aircraft will power on automatically, and click **Takeoff**.
- Select the positioning accuracy as **GNSS** in the Task Plan Library.

---

 • Quick Takeoff is only available when the dock has network connection and the network signal is strong.

---

## 3.8 Planned and Manual Flight

### Flight Procedure

The operating procedure in DJI FlightHub 2 and the automated flight procedure of the dock and the aircraft is shown in the figure:

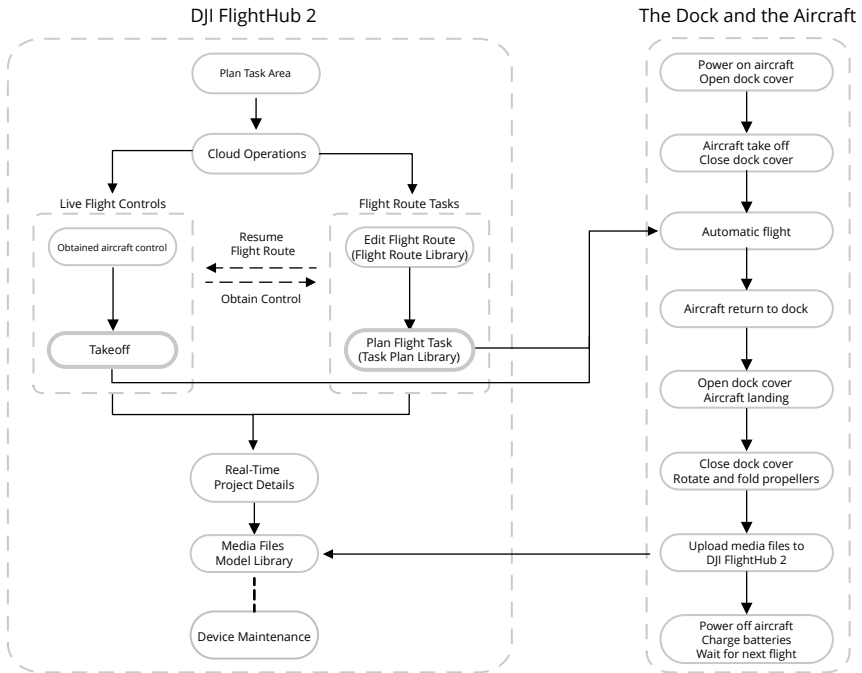

• For more details, refer to the DJI FlightHub 2 User Guide which is available on <https://fh.dji.com/user-manual/en/overview.html>.

## Flight Route Tasks

Users can create task plans in DJI FlightHub 2:

- Single-Dock Task: The aircraft will take off and land on the same dock.
- Multi-Dock Task: The aircraft will take off from one dock and land in another dock, allowing for flight tasks in large areas with long distances.



Click the link below or scan the QR code to watch the tutorial video before first time use.



<https://enterprise.dji.com/dock-3/video>

---



- Select the operation dock based on the flight routes and actual needs, and perform flight tests on the flight routes.
  - For long-distance flight routes or in environments with interference, it is recommended to install the DJI Cellular Dongle 2 and enable enhanced transmission, or install a D-RTK 3 Multifunctional Station.
  - Try lowering the flight altitude and the RTH altitude to reduce the effect of a strong wind condition. Meanwhile, check the flight altitude and the RTH altitude to ensure there are no obstacles during flight or RTH.
  - After distributing a task in DJI FlightHub 2, the dock will automatically check whether the environment (such as wind speed, rainfall, and temperature) and device status are suitable for flight tasks. If a warning message appears in DJI FlightHub 2, click the message to view warning details, and follow the instructions to conduct remote debugging.
  - If the dock network is disconnected during a flight task, the task will be interrupted and RTH will be triggered.
- 



- Multi-dock tasks only supports tasks between two docks and the distance between the docks should be less than 15 km.
- For the single-dock that is already in use, make sure to re-calibrate the dock location before performing a multi-dock task.
- For multi-dock tasks, make sure the RTK signal sources of the docks are consistent and the RTK data is FIX.
- Multi-dock tasks is not supported for the dock connected to a D-RTK 3 Multifunctional Station.
- To ensure flight safety, only RTK can be selected in the positioning accuracy for multi-dock tasks.
- Live flight controls and remote controller B will be unavailable during a multi-dock task.
- After a multi-dock task is complete, pay attention to the following:
  - If emergency landing or alternate landing is triggered during a flight task, make sure to re-link the aircraft and the dock before flying again.

- During on-site flight tests, the aircraft may be disconnected with the dock if remote controller B is linked to the aircraft. Make sure to re-link the aircraft and the dock before leaving the site.

## Terrain Follow

When collecting data in areas with large elevation differences, such as mountainous areas, Terrain Follow allows the aircraft to adjust the flight altitude following the changes in the terrain. Terrain Follow ensures that the relative height of the aircraft and the ground below remains unchanged so that the Ground Sampling Distance (GSD) of the photos collected in each area is consistent, improving the accuracy of mapping data while ensuring flight safety.

- Real-Time Terrain Follow can be enabled in the Flight Route Library 
  - Select AGL for the Altitude Mode to enable Terrain Follow.

## Real-Time Follow

Real-Time Follow does not require DSM files. The aircraft vision system detects the terrain fluctuations ahead in real time during the flight. It is recommended to use this function in areas where the terrain slope is less than 75° and the lighting condition and environment are suitable for the vision system.

When performing a mapping task while Real-Time Follow is enabled, the aircraft altitude above ground level (AGL) and the terrain trend ahead of the aircraft will be displayed in the camera view.



1. Altitude above Ground Level (AGL)
2. Aircraft Velocity Direction
3. Flight Path
4. Terrain Trend Line
5. Max Altitude

- ⚠ • To ensure flight safety, make sure that the obstacle sensing of the aircraft is enabled when using terrain follow.
  - When flying beyond the long-distance detection range of the vision system, Real-Time Follow cannot be performed. Fly with caution. Real-Time Follow cannot work in locations that feature cliffs, steep slopes, power lines, and towers.
  - The vision system cannot work properly in low-light environments. Real-Time Follow cannot be used normally in rainy, snowy, and foggy environments.
  - The vision system may not work properly over water. Therefore, the aircraft may not be able to actively detect the distance to the water for real-time follow. It is not recommended to use real-time follow in large areas of water and ocean waves.
  - The vision system cannot work properly near surfaces without clear pattern variations or where the light is too bright or too dark. The vision system cannot work properly in the following situations:
    - ◆ Flying near monochrome surfaces (e.g., pure black, white, red, or green surfaces).
    - ◆ Flying near highly reflective surfaces.
    - ◆ Flying near water or transparent surfaces.
    - ◆ Flying near moving surfaces or objects.
    - ◆ Flying in an area with frequent and drastic lighting changes.
    - ◆ Flying near extremely dark (<10 lux) or bright (>40,000 lux) surfaces.
    - ◆ Flying near surfaces that strongly reflect or absorb infrared waves (e.g., mirrors).
    - ◆ Flying near surfaces without clear patterns or textures.
    - ◆ Flying near surfaces with repeating identical patterns or textures (e.g., tiles with the same design).
    - ◆ Flying near obstacles with small surface areas (e.g., tree branches and power lines).
  - Keep the sensors clean at all times. DO NOT tamper with the sensors. DO NOT use the aircraft in dusty or humid environments.
- 

## Live Flight Controls

DJI FlightHub 2 supports sending commands directly to the aircraft that is bound to the dock and remotely operating the aircraft. **One-click landing** and **Emergency stop**



are supported in DJI FlightHub 2 in case of any emergency. Refer to the DJI FlightHub 2 User Guide at <https://fh.dji.com/user-manual/en/real-time-project-information/virtual-cockpit.html> for more information.

## Vehicle-Mounted Operation

### On-site Preparation

1. Make sure to check the following before driving:
  - a. The dock cover is closed.
  - b. Check the markers on the mounting base brackets to ensure the bolts are not loose. Make sure the anti-off steel wires are securely tightened.
  - c. Attach the sticker included in the Vehicle-Mounted Gimbal Mount package to the vehicle's center console.
2. Drive to the task area and park. Make sure that there is no obvious obstruction such as trees near the parking location. Pay attention to nearby pedestrians and vehicles to ensure safe and unobstructed task process.

---

 • When driving, pay attention to the overall height to avoid damage to the product and make sure to comply with local laws and regulations.

---

3. Make sure that the power supply and the network devices of the vehicle are working normally and that the ground rod of the dock is properly grounded.
4. Enable the dock power supply and power on the dock.

### Remote Preparation

1. **Site Assessment:** Open the device status window in DJI FlightHub 2 and click  > **Vehicle-Mounted**. Check that the device statuses including the tilt angle, number of satellites, and position convergence status are all white. If the tilt angle is red, contact the driver to adjust the vehicle location.
2. **Calibration:** Click **One-Tap Calibration**, select Network Calibration or Manual Calibration (recommend Network Calibration), and click **Save** to complete the calibration.
3. Check that the aircraft battery is fully charged.

### Operation

1. Distribute flight tasks in DJI FlightHub 2 and wait for the devices to automatically perform the task and upload media files.

2. When the task is completed, you can press the emergency stop button after closing the dock cover. When moving the vehicle, you can maintain power supply to the dock to charge the aircraft battery.

---

 • **Relative Alternate Site:** An alternate landing site that is set relative to the dock location and is recommended to set at the flat areas, such as the roof or front of the vehicle. During a vehicle-mounted task, the aircraft will land at the relative alternate site if it cannot land at the dock. The relative alternate site and relative alternate altitude are set during initial deployment and there is no need to set again before each task.

- 
-  • DO NOT move the dock during the task. If the dock is moved, the flight task will be interrupted and the aircraft will fly to the previous location of the relative alternate site for landing. Press the emergency stop button to pause the task if necessary.
- In vehicle-mounted mode, if the dock loses power and is in idle status, the backup battery will be powered on to provide short-term power. If the backup battery is also powered off, you can restore the dock power supply or restart the backup battery to continue your operations.
  - In high-temperature environments, if the dock loses power and the air conditioning system is not working, take out the aircraft and store it separately to prevent battery damage.
- 

## Dual-Drone Rotational Operation

The dock supports deploying two set of docks and aircraft for vehicle-mounted deployment, allowing for automatic rotational operation of two aircraft. To ensure flight safety, make sure to bind all the operation docks to the same project and enable **Multi-Drone Takeoff/Landing** in DJI FlightHub 2.

---

 Need to update to the latest firmware to use this function.

---

## 3.9 Return to Home

Carefully read the contents of this section to ensure you are familiar with the behavior of the aircraft in Return-to-Home (RTH).

The Return to Home (RTH) function will automatically fly the aircraft back to the last recorded Home Point. RTH can be triggered in three ways: the user actively triggers RTH, the aircraft has low battery, or the remote control signal or video transmission signal has been lost (Failsafe RTH is triggered). If the aircraft has recorded the Home Point

successfully and the positioning system is functioning normally, when the RTH function is triggered, the aircraft will automatically fly back and land at the Home Point.

## Notice

---

- ⚠ • The aircraft may not be able to return to the Home Point as normal if the positioning system is functioning abnormally. During Failsafe RTH, the aircraft may enter ATTI mode and land automatically if the positioning system is functioning abnormally.
- When there is no GNSS, do not fly over water surfaces, buildings with glass surface, or in scenarios where the altitude above the ground is greater than 30 meters. If the positioning system is functioning abnormally, the aircraft will enter ATTI mode.
- It is important to set a suitable RTH altitude before each flight. Launch DJI FlightHub 2 and set the RTH altitude. The default RTH altitude is 100 m.
- The aircraft cannot sense obstacles during RTH if the environment conditions are not suitable for the sensing system.
- GEO zones may affect the RTH. Avoid flying near GEO zones.
- The aircraft may not be able to return to a Home Point if the wind speed is too high. Fly with caution.
- Pay extra attention to small or fine objects (such as tree branches or power lines) or transparent objects (such as water or glass) during RTH. Exit RTH and control the aircraft manually in an emergency.
- Set Advanced RTH as **Preset** if there are power lines or transmission towers that the aircraft cannot bypass on the RTH path and make sure the RTH Altitude is set higher than all obstacles.
- If the max altitude is adjusted below the current altitude during RTH, the aircraft will descend to the max altitude first and then continue returning to home.
- The RTH Altitude cannot be changed during RTH.
- If there is a large difference between the current altitude and the RTH altitude, the amount of battery power used cannot be calculated accurately due to wind speed differences at different altitudes. Pay extra attention to the battery power prompts and warning prompts in DJI FlightHub 2.
- When the remote controller signal is normal during Advanced RTH, the pitch stick can be used to control the flight speed, but the orientation and altitude cannot be controlled and the aircraft cannot be controlled to fly to the left or right. Constantly pushing the pitch stick to accelerate will increase the battery power consumption speed. The aircraft cannot bypass obstacles if the flight

speed exceeds the effective sensing speed. The aircraft will brake and hover in place and exit RTH if the pitch stick is pushed all the way down. The aircraft can be controlled after the pitch stick is released.

- If the aircraft reaches the altitude limit of the aircraft current location or of the Home Point while it is ascending during Preset RTH, the aircraft stops ascending and returns to the Home Point at the current altitude. Pay attention to flight safety during RTH.
  - If the Home Point is within the Altitude Zone but the aircraft is not in the Altitude Zone, when the aircraft reaches the Altitude Zone it will descend below the altitude limit, which may be lower than the set RTH altitude. Fly with caution.
  - If the OcuSync video transmission is obstructed and disconnects, considering there may be large obstacles on the RTH route, to ensure safety during RTH, the RTH route will take the previous flight path as reference. If the aircraft is only rely on 4G enhanced transmission, pay more attention to the battery status and the RTH route in the map.
  - The aircraft will exit RTH if the surrounding environment is too complex to complete RTH, even if the sensing system is working properly.
  - RTH cannot be triggered during auto landing.
- 

## Advanced RTH

When Advanced RTH is triggered, the aircraft will automatically plan the best RTH path, which will be displayed in the app and will be adjusted according to the environment. During RTH, the aircraft will adjust the flight speed automatically according to environmental factors such as the wind speed, wind direction, and obstacles.

The user can cancel RTH after gaining aircraft control in DJI FlightHub 2.

If the control signal between the remote controller and the aircraft is good, exit RTH by pressing the RTH button or the flight pause button on the remote controller. After exiting RTH, you will regain control of the aircraft.

---

-  • When the aircraft is used with the dock to perform a flight route task, it cannot take off if there is no GNSS signal. If the GNSS signal becomes weak during flight, the flight route task will be interrupted and RTH will be triggered.
- It is recommended to mark the waypoint with obstacle above as no-return point to ensure the flight safety during RTH.
- DO NOT update the Home Point after gaining control using remote controller B. Otherwise, the aircraft may not return to the dock if the Home Point is updated.

- When the lighting is insufficient and the environment is not suitable for the vision system, the aircraft cannot avoid obstacles during RTH.
  - In rainy or foggy weather, the vision system is unavailable and the RTH route may be inaccurate, which can cause flight safety risks. Avoid flying when it is rainy, smoggy, or the visibility is lower than 100 m.
- 

## Trigger Method

### The user actively triggers RTH

Advanced RTH can be initiated by clicking Return to Home in the device status window or the virtual cockpit in DJI FlightHub 2.

During flight, you can trigger RTH by pressing and holding the RTH button on the remote controller.

### Aircraft low battery

During flight, if the battery level is low and only sufficient to fly to the Home Point, a warning prompt will appear in DJI FlightHub 2. The aircraft will automatically initiate low battery RTH.

If you cancel the low battery RTH prompt and continue flying the aircraft, the aircraft will land automatically when the current battery level can only support the aircraft long enough to descend from its current altitude.

Auto landing cannot be cancelled but you can still fly the aircraft horizontally by moving the pitch stick and roll stick, and change the descent speed of the aircraft by moving the throttle stick. Fly the aircraft to a suitable place for landing as soon as possible.



- When the Intelligent Flight Battery level is too low and there is not enough power to return home, land the aircraft as soon as possible. Otherwise, the aircraft will crash after the battery power is completely depleted.
  - DO NOT keep pushing the throttle stick upward during auto landing. Otherwise, the aircraft will crash after the battery power is completely depleted.
- 

### Loss of remote control or video transmission signal

When the signal lost action is set to RTH, RTH automatically activates after the control signal is lost for more than six seconds.

When the lighting and environment conditions are suitable for the vision system, the aircraft will start RTH using Advanced RTH according to the RTH settings. The aircraft will remain in RTH even if the signal is restored.

When the lighting and environment conditions are unsuitable for the vision system, the aircraft will brake and hover, then enter Original Route RTH.

- If the RTH distance (the horizontal distance between the aircraft and the Home Point) is farther than 50 m, the aircraft adjusts its orientation and flies backward for 50 m on its original flight route before entering Preset RTH.
- If the RTH distance is farther than 5 m but less than 50 m, the aircraft adjusts its orientation and flies straight horizontally back to the home point at the current altitude.
- If the RTH distance is less than 5 m, the aircraft will fly above the dock and land.

## RTH Procedure

After Advanced RTH is triggered, the aircraft brakes and hovers in place.

- **When the environment or lighting conditions are suitable for the vision system:**
  - ♦ The aircraft will adjust its orientation to the Home Point, plan the best path according to the RTH settings and then return to the Home Point if GNSS was available when takeoff.
- **When the environment or lighting conditions are not suitable for the vision system:**
  - ♦ If the RTH distance is further than 5 m, the aircraft will return to home according to the **Preset**.
  - ♦ If the RTH distance is less than 5 m, the aircraft will fly above the dock and land.

## Terrain Data

Users can click  on the project page in DJI FlightHub 2 to enter the Map Task Area, enable **Obstacle Data**, and the obstacle data will be distributed to the dock aircraft. Based on the terrain data, the aircraft can plan an optimal flight path to bypass obstacles along the path during RTH.

When terrain data is enabled,

- if the environment or lighting conditions are suitable for the vision system, the aircraft will automatically plan an optimal flight path based on the terrain data and the data collected by the vision system. The optimal flight path will maintain a safe distance from the terrain obstacles.
- If the environment or lighting conditions are not suitable for the vision system, only the terrain data is effective. Safety risks may arise if the model data is inaccurate.



- Based on the terrain data, the aircraft will bypass the area that has weak GNSS signal to ensure aircraft positioning accuracy. If there are suspended models in

the terrain data, such as cranes, power lines, and bridges, the aircraft will try to bypass the obstacles by flying above the objects.

- ⚠ • When the aircraft is using GNSS for positioning, the positioning accuracy is relatively low, and the obstacle bypassing performance may be affected. Users should fly with caution, and pay close attention to the flight route and the camera view.

## RTH Settings

RTH settings are available for Advanced RTH. **Optimal Route Planning** can be enabled in DJI FlightHub 2 under **Live Flight Controls** before taking off. **Optimal Route Planning** can also be enabled in the **Task Plan Library** when creating a task plan.

- **Optimal:**

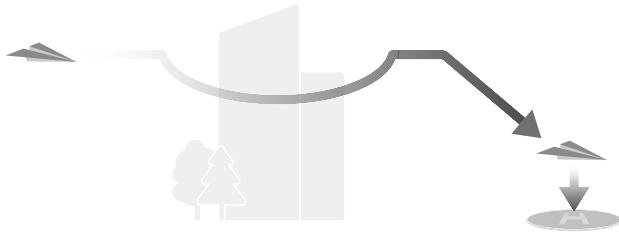

- If the lighting is sufficient and the environment is suitable for the vision system, the aircraft will automatically plan the optimal RTH path and adjust the altitude according to environmental factors, such as obstacles and transmission signals, regardless of the RTH Altitude setting. The optimal RTH path means the aircraft will travel the shortest distance possible to reduce the amount of battery power used and to increase flight time.
- If the lighting is insufficient or the environment is not suitable for the vision system, the aircraft will perform Preset RTH based on the RTH Altitude setting.
- **Preset:**



RTH Distance/Altitude		Suitable Lighting and Environment Conditions	Unsuitable Lighting and Environment Conditions
RTH distance > 50 m	Current altitude < RTH altitude	The aircraft will plan the RTH path, fly to an open area while bypassing obstacles, ascend to the RTH Altitude, and return to home using the best path.	The aircraft will ascend to the RTH altitude, and fly to the Home Point in a straight line at the RTH altitude. <sup>[1]</sup>
	Current altitude ≥ RTH altitude	The aircraft will return to home using the best path at the current altitude.	The aircraft will fly to the Home Point in a straight line at the current altitude.
RTH distance is within 5-50 m			

[1] If the forward-facing LiDAR detects an obstacle ahead, the aircraft will ascend to avoid the obstacle. It will stop climbing once the path ahead is clear and then continue to RTH. If the obstacle height exceeds the altitude limit, a prompt will appear in DJI Pilot 2 and the user will need to take control. Fly with caution.

When the aircraft is approaching the Home Point, if the current altitude is higher than the RTH altitude, the aircraft will intelligently decide whether to descend while flying forward according to the surrounding environment, lighting, the set RTH altitude, and the current altitude. When the aircraft reaches the area above the Home Point, the current altitude of the aircraft will not be lower than the set RTH altitude.

The RTH plans for different environments, RTH trigger methods, and RTH settings are as follows:

RTH Trigger Method	Suitable Lighting and Environment Conditions (The aircraft can bypass obstacles and GEO zones)	Unsuitable Lighting and Environment Conditions
The user actively triggers RTH	The aircraft will execute RTH based on the RTH setting:	Preset (The aircraft can ascend to bypass obstacles and GEO zones)
Aircraft low battery		Original route RTH, Preset RTH will be executed when the signal is restored (The aircraft can ascend to bypass obstacles and GEO zones)
Loss of remote controller signal		



## Dock Landing Detection

During RTH, dock landing detection activates once the aircraft begins to land.

The specific performance of the aircraft is as follows:

1. If dock landing detection determines the dock is suitable for landing, the aircraft will land on the dock directly.
2. If the dock is not suitable for landing (the dock cover fails to open, emergency stop button is pressed), the aircraft will fly to the alternate landing site.
3. If dock landing detection is not operational (when the dock and the aircraft are disconnected), the aircraft will descend to 5 m (9.8 ft) above the ground and hover, and will fly to the alternate landing site when the battery level is low.

- 
-  • If the alternate landing site is not set, the aircraft will hover and start descending when the battery level is too low. Make sure to set an alternate landing site during dock deployment. Otherwise, the aircraft may crash land, damaging the aircraft and the dock.
- 

## 3.10 System Shutdown

After completing a flight task, the aircraft will land on the landing pad, the dock cover will close and the dock will charge the aircraft. The media files will be automatically uploaded to the cloud before the aircraft powers off.

If the remote controller is used, push the throttle stick down and hold to stop the motors after landing. Press, then press and hold the power button to power off aircraft and the remote controller.

## 3.11 Post-Flight Inspection

1. Make sure that the aircraft has landed in the dock, and the dock covers are closed properly.
2. Make sure the media files are automatically uploaded to the cloud, and the media files can be captured properly during flight.
3. Make sure to view the warning details of the dock and aircraft in DJI FlightHub 2.
4. Check if there is any error message in DJI FlightHub 2.
5. Check if the aircraft can be powered off and charged by the dock properly.
6. Check if the dock is working normally.

Inspect the following items if the remote controller is used to take control of the aircraft manually during on-site flight tests.

1. Make sure that the aircraft is powered off.
2. Make sure to perform a visual inspection so that the aircraft, remote controller, gimbal camera, Intelligent Flight Batteries, and propellers are in good condition. Contact DJI support if any damage is noticed.
3. Make sure that the camera lens and vision system sensors are clean.
4. Check the aircraft structure, clean the dirt and dust, and replace any loose or damaged parts.
5. Make sure the aircraft is placed properly on the landing pad and the aircraft heading is consistent with the arrow mark, and the propellers are at 90° with each other.
6. Make sure that the battery port on the aircraft is clean and dry.

## 4 Emergency Procedures

### 4.1 Fire

A prompt will appear in DJI FlightHub 2 and the flight controller will reduce the power of the aircraft when the Intelligent Flight Battery temperature is too high. The battery will be locked for future use if the temperature is too high during flight and cannot be used again after landing.

Follow the instructions below if the Intelligent Flight Battery catches fire:

1. If the battery catches fire when it is being charged using a charging device, make sure that personal safety is guaranteed, power off the charging device immediately, and disconnect the battery from the charging device. If the battery catches fire when the battery is in the aircraft, make sure that personal safety is guaranteed and remove the battery from the aircraft immediately.
2. Move the flammable materials surrounding the battery to a safe distance of more than 5 m .
3. If the fire is controllable, use a large amount of sand to cover the location of the fire and pour cold water to cool the battery until there is no smoke coming out. Use fire-resistant gloves or other protective tools to avoid direct contact with the battery. Move the battery to a container with an appropriate amount of salt solution, and then fully immerse the battery in the solution. Leave the container in a cool place for more than 72 hours to fully discharge the battery and take out the battery and dispose it.
4. If the fire is uncontrollable, double check that there are no flammable materials surrounding the battery, extend the safety distance to more than 10 m, and evacuate people from the surrounding area. Wait until the battery burns out and the fire is extinguished in order to avoid any further accidents.

### 4.2 Loss of C2 Link

The aircraft will perform the signal lost action if the control signal is lost during flight. Refer to the [Loss of remote control or video transmission signal](#) section for more information.

## 4.3 Loss of Navigation Systems

When using fixed RTK positioning, the aircraft will switch to GNSS if RTK is unavailable during flight. If GNSS is also unavailable, the aircraft will switch to Attitude (ATTI) mode automatically to stabilize its attitude.

## 4.4 Control Station Failures

### Loss of Control Signal

If the control signal is lost during flight, the aircraft will perform signal lost action. Refer to the [Loss of remote control or video transmission signal](#) section for more information.

### DJI FlightHub 2 Failure

If DJI FlightHub 2 crashes during automatic operations while the control signal is normal, the C2 link between the aircraft and the control station is still in good condition, so the aircraft will continue performing the current operation until RTH is triggered by low battery level.

### Alternate Landing

If the dock is determined unsuitable for landing, alternate landing will be triggered. The aircraft will ascend to the alternate route altitude, then fly to the alternate landing site for landing. Open DJI FlightHub 2, Click **Devices > Dock** and then  to check the alternate route altitude.

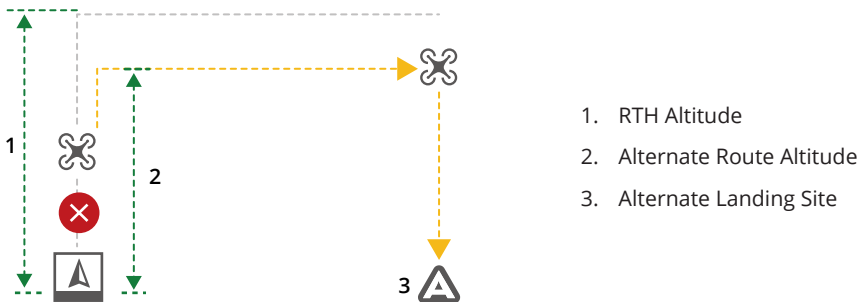

 • To ensure flight safety, make sure to set an alternate landing site and suitable alternate route altitude when configuring the dock.

## Remote Controller B

To ensure flight test safety, the remote controller can be used to take control of the aircraft manually during on-site flight tests after connecting to the aircraft as controller B.

### Connecting Controller B

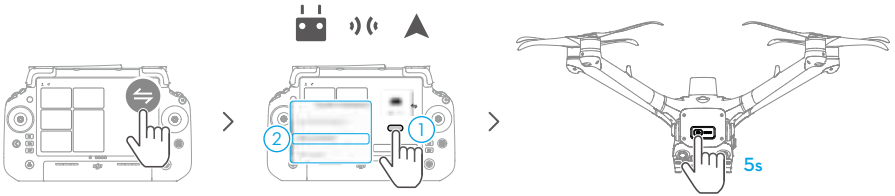

- ⚠ • Controller B is supported to be used when no relay station is deployed.
- Make sure to link the dock and the aircraft first, and then link the remote controller B and the aircraft.
- The remote controller should be purchased separately. Pay attention to flight safety when manually controlling with the remote controller.

### Gaining Control via Controller B

1. Run DJI Pilot 2 and tap **Enter Camera View** on the homepage. Users will be directed to the camera view by default after finishing the preflight check.
2. Tap  on the upper left corner to gain control.
3. Press the flight pause button on the remote controller B to interrupt the flight route and control the aircraft.

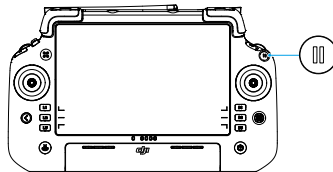

- ⚠ • DO NOT update the Home Point after gaining control. Otherwise the aircraft cannot return to the dock.
- After gaining control with remote controller B and if a flight task is initiated from the DJI FlightHub 2, DO NOT take off using the remote controller B.

## Flight Modes

The aircraft supports the following flight modes, which can be switched via the Flight Mode switch on the remote controller.

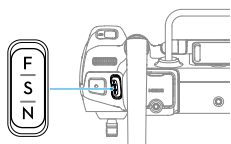

Position	Flight Mode
F	Function mode
S	Sport mode
N	Normal mode

### Normal Mode

Normal Mode is suitable for most flight scenarios. The aircraft can hover precisely, fly stably, and use Intelligent Flight Modes. If obstacle sensing is enabled, obstacles can also be avoided using the vision system.

### Sport Mode

The maximum horizontal flight speed of the aircraft will be higher when compared with Normal mode. Note that obstacle sensing is disabled in Sport Mode.

### Function Mode

Function mode can be set to T-mode (Tripod mode) in DJI Pilot 2. T-mode is based on Normal mode. The flight speed is limited to allow easier control of the aircraft.

Environmental factors such as wind can result in horizontal drift of the aircraft, which may present hazards, especially when flying in confined spaces. The aircraft will not be able to hover or brake automatically, therefore the pilot should land the aircraft as soon as possible to avoid accidents.

If the aircraft is flying in the EU, the aircraft will switch to Low Speed mode on the remote controller. Low Speed mode limits the maximum horizontal flight speed to 2.8 m/s based on Normal mode, and there is no limit for the ascent or descent speed.

-  DO NOT switch from Normal mode to other modes unless you are sufficiently familiar with the aircraft behavior under each flight mode. You must turn on Multiple Flight Modes in DJI Pilot 2 before switching from Normal mode to other modes.

-  The vision systems are disabled in Sport mode, which means the aircraft cannot sense obstacles on its route automatically. The user must stay alert to the surrounding environment and control the aircraft to avoid obstacles.
- The maximum flight speed and braking distance of the aircraft significantly increases in Sport mode. When flying in windless conditions, make sure to maintain enough braking distance to ensure flight safety.

- When the aircraft is ascending or descending in Sport mode or Normal mode in windless conditions, make sure to maintain enough vertical braking distance to ensure flight safety.
  - The responsiveness of the aircraft significantly increases in Sport mode, which means a small control stick movement on the remote control device translates into the aircraft moving a large distance. Make sure to maintain adequate maneuvering space during flight.
- 

## Emergency Stop Button

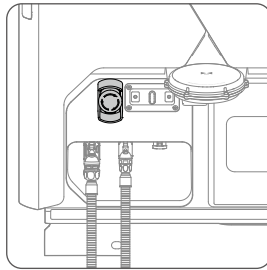

In an emergency, press the emergency stop button to stop all dock movements when operating or maintaining the dock. The status indicators blink red and yellow alternatively after pressing the emergency stop button.

If the aircraft is powered on but the motors are not running, the aircraft cannot take off after pressing the emergency stop button. If the emergency stop button is pressed when the aircraft is performing a flight task, the aircraft will fly to the alternate landing site after completing the flight task.



- Pull out or rotate the button clockwise to release the emergency stop button before performing any dock operations (e.g. dock cover control).
- 

## Other Failures

When other dock failures occur, such as when the dock has no power supply, no network connection, or when the dock cover cannot be opened, perform troubleshooting.

## 4.5 Flyaway

When the aircraft is connected to the dock, the coordinates of the aircraft will be uploaded to the cloud and can be viewed in DJI FlightHub 2.

When the aircraft is disconnected from the dock, the last recorded time and coordinates of the aircraft will be displayed in the device status window in DJI FlightHub 2. Users can click the information to center the aircraft location in the middle of the map and then right-click to create a PinPoint to help locate the aircraft during a search. The information will not be displayed after the aircraft re-connects to the dock.



## 5 Handling, Servicing and Instructions for Maintenance

### 5.1 Storage

#### Dock Storage

If the dock is not used immediately, follow the requirements as shown below for temporary storage:

- Store it in a dry, rainproof, and fireproof place with no corrosive materials.
- Protect it from erosion and damage caused by wildlife.
- Make sure to check that the outer packaging of the dock is in good condition regularly. Make sure to charge the backup battery for at least 6 hours every three months.
- If the dock is removed from storage and not used for a period of time, place it in a water-resistant bag sealed with adhesive tape and then store it in the original packaging with a desiccant.
- DO NOT tilt or invert the dock or place items on top of the box when the dock is stored in the box.
- If the installed dock is left outdoors for an extended period, make sure to remove the aircraft from the dock and store it separately. Properly package and transport the aircraft separately.

#### Aircraft Storage

When the dock is powered on and working normally, the air conditioning system can adjust the environment temperature making the environment suitable for storage. If stored separately, take out the aircraft from the dock and follow the requirements below:

- Keep the aircraft and parts clean and dry and store them in a cool dry place. Recommended storage temperature: between  $-20^{\circ}$  and  $50^{\circ}$  C ( $-4^{\circ}$  and  $122^{\circ}$  F).
- Make sure small parts are stored properly to avoid loss. Small parts, such as cables and straps are dangerous if swallowed. Keep all parts out of reach of children and animals.
- Remove the battery from the aircraft and install the gimbal protector when stored.

## Battery Storage

When the dock is powered on and working normally, the air conditioning system can adjust the environment temperature making the environment suitable for storage.

Remove the battery from the aircraft if stored separately, refer to the Safety Guidelines and follow the instructions on battery storage.

Storing power at proper levels can extend battery life. Refer to the figure below for the **Maximum Storage Days (Y)** when storing at different **Battery Level (X)**.

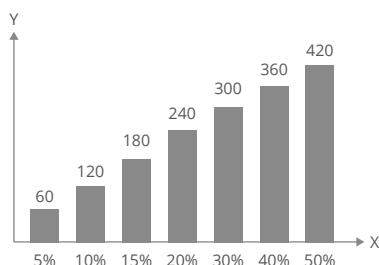

- 
- ⚠ The battery will be damaged once it exceeds the maximum storage period. The battery should no longer be used.
  - The actual maximum storage period will vary slightly due to the batteries being part of different production batches and stored in different environments.
  - The maximum storage days are theoretically calculated at room temperature. Storing the battery in high-temperature environments will significantly shorten the battery life and the storage days will be significantly reduced.
- 

## 5.2 Charging the Battery

### Charging via the Dock

The battery can be charged via the dock when it is inserted into the aircraft. Charging will begin after the battery temperature reaches the charging temperature range. In this case, the charging time will be extended.

To charge the Intelligent Flight Battery, open the DJI FlightHub 2 Project page, click > > **Action**, enable **Remote Debugging**, and then click **Charge**.



- Users can also charge the battery in the Device Maintenance page: open the DJI FlightHub 2 Project page, click **Dock** > , enable **Remote Debugging**, and then click **Charge**.
- After the dock is powered on, DO NOT place any metal objects such as rings or any electronic devices on the landing pad, or touch the landing pad surface when placing the aircraft on the landing pad to avoid burns.
  - To ensure safety, the dock cannot charge the aircraft battery when the dock cover is opened.

## Charging Mode

Charging Mode can be set as Schedule or Standby in DJI FlightHub 2. When the dock is in idle status, the battery level and the temperature inside the dock can be automatically modified to meet different scenarios.

Schedule mode is suitable for performing regular tasks such as patrol inspections. The battery will be charged and stored at approximately 60% when no task is distributed.

Standby mode is suitable for performing urgent tasks such as fire rescue. The battery will be charged and stored at approximately 95% when no task is distributed.

Switching charging modes: Open the DJI FlightHub 2 project page, click  > , and then **Action** to switch to different charging modes.

- Battery level may be low under Schedule mode. If the **Plan Timer** is selected as **Immediate**, Low Battery RTH may be triggered during the flight task.
- Maintaining a high power level in Standby mode will affect battery life. It is recommended to select Schedule mode if the scenario is not urgent.

## Using the Charging Hub

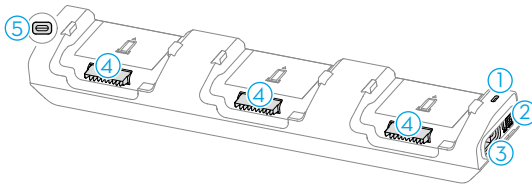

1. Status LED
2. Power Port
3. Mode Switch
4. Battery Port
5. USB-C Assistant Port

## Usage

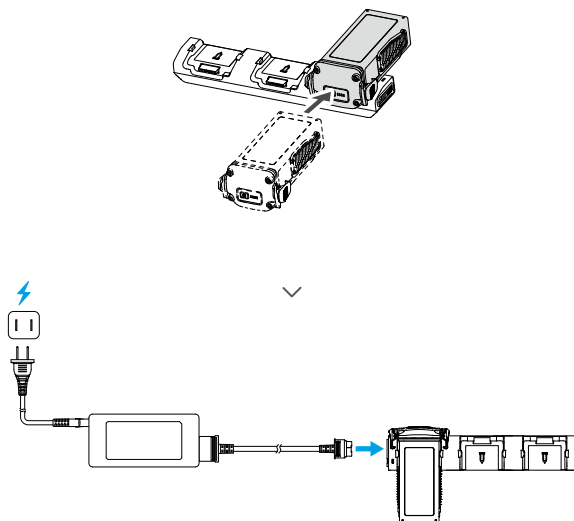

Toggle the mode switch to select a charging mode.

**100%** **Standard Mode:** Each battery is charged to 100% in sequence.

**90%** **Ready-to-Fly Mode:** Each battery is charged to 90% in sequence. This mode facilitates quick use of batteries.

The charging hub will charge the batteries based on the charging temperature and the current battery level. The battery with the shortest charging time will be charged first.

Disconnect the Intelligent Flight Battery from the charging hub when charging is complete.





### Status LED Descriptions

Blinking Pattern	Description
Solid yellow	No battery is inserted
Pulses green	Charging the battery
Solid green	Charging completed
Blinks yellow	Exceed the charging temperature range (no further operation needed, charging can continue after battery or charging hub automatically recovers)
Solid red	Unrecoverable abnormality of battery or charging hub (remove and reinsert the battery or unplug and plug in the adapter)

- ⚠ • The DJI 240W Power Adapter is required when using the charging hub to charge Intelligent Flight Batteries.
  - The charging hub is only compatible with specific model of the Intelligent Flight Battery. DO NOT use the charging hub with other battery models.
  - Place the charging hub on a flat and stable surface when in use. Make sure the device is properly insulated to prevent fire hazards.
  - DO NOT touch the metal terminals on the battery ports. Clean the metal terminals with a clean, dry cloth if there is any noticeable buildup.
- 
- 💡 • The USB-C assistant port can only be used to update the firmware of the charging hub.







## Battery Level LEDs



The table below shows the battery level during charging.

Blinking Pattern	Battery Level
	0-50%
	51-75%
	76-99%
	100%

## Battery Protection Mechanisms

The battery level LEDs can display battery protection notifications triggered by abnormal charging conditions.

LEDs	Blinking Pattern	Status
	LED2 and LED4 blink three times per second	Aircraft short circuit/overcurrent at power on
	LED2 and LED4 blink two times per second	Undervoltage at power on
	LED2 blinks twice per second	Overcurrent detected
	LED2 blinks three times per second	Short circuit detected
	LED3 blinks twice per second	Overcharge detected
	LED3 blinks three times per second	Over-voltage charger detected
	LED4 blinks twice per second	Charging temperature is too low

LEDs	Blinking Pattern	Status
	LED4 blinks three times per second	Charging temperature is too high
	All 4 LEDs blink fast	The battery is abnormal and unavailable

If any of the battery protection mechanisms are activated, unplug the charger, and plug it in again to resume charging. If the charging temperature is abnormal, wait for it to return to normal. The battery will automatically resume charging without the need to unplug and plug in the charger again.

## 5.3 Conditioning Batteries

The Intelligent Flight Battery will perform a self-evaluation and the dock will automatically maintain the battery to ensure optimal battery performance. If a warning message appears in DJI FlightHub 2, click the message to view warning details, and follow the instructions to perform battery maintenance.

When the battery life is approaching, a prompt will appear in DJI FlightHub 2. If users continue to use the battery, the dock cannot perform flight tasks when the battery life is reached.

- 
-  • The battery contains hazardous chemicals, DO NOT dispose of the battery in a regular waste disposal container. Strictly follow local laws and regulations regarding the disposal and recycling of batteries.
  - Batteries that are over-discharged, swollen, involved in a crash, come into contact with liquid, damaged, or leaky must be disposed. DO NOT use any battery in such a condition to avoid damage or injury. Contact a professional battery disposal or recycling agent for further assistance.
- 

## 5.4 Cleaning and Maintaining

Refer to the *Maintenance Manual* for more information.

## 6 Appendix

### 6.1 Firmware Update

#### Using DJI FlightHub 2

1. Power on the aircraft and the dock. Make sure the aircraft and the dock are linked, and the battery level of the aircraft is higher than 50%.
2. Open DJI FlightHub 2, and click **Devices > Dock**.
3. Click **Can Update**, and a prompt will appear in the window indicating the firmware version and updates.
4. Select the checkbox on the left to upgrade device firmware in batches.
5. Click **Update**, the firmware will be downloaded automatically.
6. The firmware of both the dock and the aircraft will be updated simultaneously. If the aircraft is not placed inside the dock, only the dock firmware will be updated.

---

 • Make sure DJI FlightHub 2 is connected to the internet during the whole update process.

---

 • The devices and battery installed on the aircraft will be updated to the latest firmware version.

- Users cannot operate the aircraft or the dock during a firmware update. The aircraft and the dock will be available after the update is complete or cancelled.

---

#### Using DJI Assistant 2 (Enterprise Series)

##### Aircraft and Control Station Firmware Update

1. Connect the DJI device to a computer separately, as the DJI Assistant 2 does not support updating multiple DJI devices at the same time.
2. Make sure the computer is connected to the internet and the DJI device is powered on.
3. Launch DJI Assistant 2 and log in with a DJI account.
4. Tap the **firmware update** on the left side of the main interface.
5. Select the firmware version and click to update. The firmware will be downloaded and updated automatically.
6. When the "Update successful" prompt appears, the update is completed, and the DJI device will restart automatically.

## Notices

---

- ⚠ • Make sure the aircraft and remote controller are fully charged before updating the firmware.
  - DO NOT remove accessories or turn off the devices during the update process.
  - The battery firmware is included in the aircraft firmware. Be sure to update all batteries.
  - During the update process, it is normal for the gimbal to go limp, the aircraft status indicators to blink, and the aircraft to reboot. Wait patiently for the update to complete.
  - Make sure to keep the aircraft away from people and animals during a firmware update, system calibration, or parameter configuration.
  - For safety, make sure you are using the latest firmware version.
  - After the firmware update is completed, the remote controller and the aircraft may become disconnected. Reconnect the devices if necessary.
- 

Visit the following link and refer to the *Release Notes* for firmware update information:

<https://enterprise.dji.com/dock-3/downloads>

## 6.2 Expansion Port

The aircraft is equipped with an E-Port to support PSDK, enabling more feature development. Visit <https://developer.dji.com> for more information about SDK development and instructions.

## Installation Requirements

- The device supports installing official accessories such as the speaker, the spotlight, and the obstacle sensing module \*. The detection range of the aircraft vision system and obstacle sensing performance of the aircraft will be limited. Fly with caution. Make sure to re-calibrate the aircraft compass after installing the speaker. Visit <https://enterprise.dji.com/dock-3/downloads> to view the accessory user guide and learn about how to use the product.
- \* When the obstacle sensing module is enabled (operating 60-64 GHz), the UAVs limit their altitude operation to the regulations established by Transport Canada (e.g. altitudes below 122 metres above ground)



- Installing payloads will shorten the flight time and reduce the aircraft wind resistance. Make sure to install the payload as needed. Refer to the accessory user guide for more information.
- Make sure to securely installed the payload and tightened all the screws. Use the included screwdriver to tighten the screws again after installation. Loose installation may affect the overall water-resistant performance or even cause the payload from falling during flight, which will seriously affect flight safety.

## Third-Party Payload Requirements

- Installing a third-party payload may affect the aircraft performance (such as video transmission, GNSS and obstacle sensing) and flight safety. It is recommended to use official payloads or the payloads in the Enterprise Ecosystem Solution Catalogue. The payload size must meet Payload Development Criteria. Visit <https://developer.dji.com> for more information.
- Make sure that the total weight of the aircraft does not exceed the maximum takeoff weight.
- The third-party payload should have a protection rating equal to or higher than that of the aircraft in order not to reduce the working stability or the service life of the aircraft. It is recommended to test the water-resistant performance with the payload installed. If water leaks into the aircraft, it will seriously affect flight safety.
- After installing the third-party payload, perform a stability test to ensure that there will be no interface disconnection, aircraft GNSS satellite search affected, video transmission performance degraded, or incorrect obstacle sensing.

## 6.3 Using Enhanced Transmission



Click the link below or scan the QR code to watch the tutorial video before first time use.



<https://enterprise.dji.com/dock-3/video>

Enhanced Transmission integrates OcuSync video transmission technology with 4G networks. If the OcuSync video transmission is obstructed, experiencing interference, or used over long distances, 4G connectivity allows you to maintain aircraft control.

The installation requirements are as shown below:

- The aircraft needs to be installed with a DJI Cellular Dongle 2. Both the dongle and nano-SIM card need to be purchased separately.
- The dock needs to be connected to a wired network or be installed with the DJI Cellular Dongle 2 to connect to a 4G wireless network.

Enhanced Transmission will consume data. If the transmission completely switches to a 4G network, a 30-minute flight consumes about 1 GB of data on the aircraft and the remote controller, respectively. This value is for reference only. Refer to the actual data usage.



- Enhanced Transmission is only supported in some countries and regions.
  - The DJI Cellular Dongle 2 and its related service are only available in some countries and regions. Comply with local laws and regulations and DJI Cellular Dongle 2 Terms of Service.
- 

## Inserting the nano-SIM Card

Open the SIM card slot cover on the dongle, insert the nano-SIM card into the slot in the same direction as shown in the figure, and close the cover.

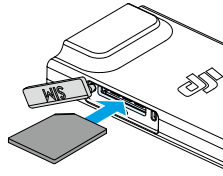

- 
- ⚠ • It is strongly recommended to purchase a nano-SIM card which supports a 4G network from official channels of the local mobile network operator.
  - DO NOT use an IoT SIM card, otherwise the video transmission quality will be seriously compromised.
  - DO NOT use a SIM card provided by the virtual mobile network operator, otherwise it may lead to an inability to connect to the Internet .
  - DO NOT cut the SIM card by yourself, otherwise the SIM card may be damaged, or the rough edges and corners may cause the SIM card to be unable to be inserted or removed properly.
  - If the SIM card is set with a password (PIN code), make sure to insert the SIM card into the smartphone and cancel the PIN code setting, otherwise it will fail to connect to the Internet.
- 
- 💡 • Open the cover and push the nano-SIM card to partially eject it.
- 



## Installing DJI Cellular Dongle 2

Refer to the Installation and Setup Manual to install the DJI Cellular Dongle 2 for the dock and the aircraft.

- 
- ⚠ • Due to high data consumption on the dock, there might be latency or other problems in the livestream if the dock only uses the 4G wireless network for video transmission. It is recommended to connect to a wired network for enhanced transmission.
- 

## Using Enhanced Transmission

When the aircraft is installed with the DJI Cellular Dongle 2, and the dock is connected to a network (wired network or wireless network), users can enable Enhanced Transmission via the following methods:

- Open the DJI FlightHub 2 Project page, click  >  to open the device status window. Make sure the aircraft is powered on. Click **Action > Remote Debugging**, and then enable or disable Enhanced Transmission.
- Make sure the aircraft is powered on. Open the DJI FlightHub 2 Devices Page, click **Dock > **. Enable Remote Debugging, and then enable or disable Enhanced Transmission.

- 
-  • Pay close attention to the video transmission signal strength after enabling Enhanced Transmission. Fly with caution.
- 

## Security Strategy

Based on safe flight considerations, Enhanced Transmission can only be enabled when the OcuSync video transmission is in effect. If the OcuSync link is disconnected during flight, it is not possible to disable Enhanced Transmission.

## 4G Network Requirements

The 4G network transmission speed is determined by the 4G signal strength of the aircraft and the remote controller at the current position and the network congestion level of the corresponding base station. The actual transmission experience is closely related to the local 4G network signal conditions. The 4G network signal conditions include both sides of the aircraft and the remote controller with various speeds. If the network signal of either the aircraft or remote controller is weak, has no signal, or is busy, the experience of 4G transmission may drop and lead to the video transmission freezing, a delayed response of the controls, loss of video transmission, or loss of controls.

Therefore, when using Enhanced Transmission:

1. Make sure to use the remote controller and aircraft in locations where the 4G signal is close to full for a better transmission experience.
2. If the OcuSync signal is disconnected, the video transmission may lag and stutter when the aircraft relies fully on a 4G signal. Fly with caution.
3. When the OcuSync signal is poor or disconnected, make sure to maintain an appropriate altitude during the flight. In open areas, try to keep the flight altitude below 120 meters for a better 4G signal.
4. For flight in the city with tall buildings, make sure to set a suitable RTH altitude (higher than the tallest building).
5. When the app prompts that the 4G signal is weak, fly with caution.

## 6.4 Troubleshooting Procedures

### 1. How to solve the gimbal drift issue during flight?

Calibrate IMU and compass in DJI Pilot 2. If the problem persists, contact DJI Support.

### 2. No function

Check if the Intelligent Flight battery and the remote controller are activated by charging. If the problems persist, contact DJI Support.

### 3. Power-on and start-up problems

Check if the battery has power. If yes, contact DJI Support if it cannot be started normally.

### 4. Firmware update issues

Follow the instructions in the user manual to update the firmware. If the firmware update fails, restart all the devices and try again. If the problem persists, contact DJI Support.

### 5. Procedures to reset to factory default

Use the DJI Pilot 2 app to reset to factory default settings.

### 6. Shutdown and power-off problems

Contact DJI Support.

### 7. How to detect careless handling or storage in unsafe conditions

Contact DJI Support.

## 6.5 Risks and Warnings

When the aircraft detects a risk after powering on, there will be a warning prompt on DJI FlightHub 2. Pay attention to the list of situations below.

- If the location is not suitable for takeoff.
- If an obstacle is detected during flight.
- If the location is not suitable for landing.
- If the compass and IMU experience interference and need to be calibrated.
- Follow the on-screen instructions when prompted.

## 6.6 Disposal



Observe the local regulations related to electronic devices when disposing of the aircraft and remote controller.

### Battery Disposal

Dispose of the batteries in specific recycling containers only after a complete discharge. DO NOT dispose of the batteries in regular trash containers. Strictly follow the local regulations regarding the disposal and recycling of batteries.

Dispose of a battery immediately if it cannot be powered on after over-discharging.

If the power button is disabled and the battery cannot be fully discharged, contact a professional battery disposal/recycling agency for further assistance.

## 6.7 C2 and C6 Certification

The aircraft model and corresponding UAS class is listed below. There are some requirements and restrictions when using the aircraft in European Economic Area (EEA, i.e. EU plus Norway, Iceland, Liechtenstein, Switzerland, and Georgia). Make sure the pilot has the necessary competency.

Please use the drone in compliance with local regulations. Any risks arising from non-compliant usage are the sole responsibility of the user.

Note that under C6 scope, the remote controller can only be used for emergency landing. Using the remote controller for emergency control and flight operations is out of C6 scope.

Model	M4D, M4TD
UAS Class	C2 C6 (When used with DJI Dock 3, Model: DOCK-03)
Maximum Take-Off Mass (MTOM)	2090 g
Sound Power Level	88 dB
Maximum Propeller Speed	6300 RPM

### Maximum Dimensions (L×W×H):

377.7×416.2×212.5 mm (without propellers)

666.6×710.3×223.2 mm (with propellers)

## MTOM Statement

The MTOM of DJI Matrice 4TD & DJI Matrice 4D (Model M4D & M4TD) is 2090 g to comply with C2 & C6 requirements.

Users must follow the instructions below to comply with the MTOM requirements for each model:

1. Make sure that when installing any external devices that the total weight of the aircraft does not exceed the maximum takeoff weight. In addition, the external device must be installed in a location so that the center of gravity is maintained within the range of the aircraft top shell to keep the aircraft stable and that the vision systems, the infrared sensing systems, and the auxiliary lights are not blocked. Ensure that the Maximum Takeoff Mass (MTOM) does not exceed the specified limit for any flight.
2. DO NOT use any non-qualified replacement parts, such as intelligent flight batteries or propellers, etc.
3. DO NOT retrofit the aircraft.

- 
-  • The prompt "Low Battery RTH" will not appear if the horizontal distance between the pilot and the aircraft is closer than 5 m.
- The auxiliary LED is set to auto when used in the EU and cannot be changed. The aircraft Front Arm LEDs are always on when used in the EU and cannot be changed.
  - Make sure to use official software for operations that require connecting to external devices, such as firmware updates and exporting media files.
- 

## List of Items, including qualified accessories

Item	Model Number	Dimensions	Weight
Propellers	1364F		
Battery	BPX230-6768-22.14	154×96×59 mm	Approx. 640 g
AL1 SpotLight <sup>[1]</sup>	AL-1	With bracket: 95×164×30 mm	With bracket: 99 g
AS1 Speaker <sup>[1]</sup>	AS-1	With bracket: 73×70×52 mm Without bracket: 73×70×47 mm	With bracket: 92.5 g Without bracket: 90 g
Obstacle Sensing Module <sup>[1]</sup>	LR-01	103.3×63.9×85.8 m	Approx. 235 g
microSD Card	N/A	8.8×12.3×0.7 mm	0.26 g
DJI Cellular Dongle 2	IG831T	43.5×23.0×7.0 mm	Approx. 11.5 g

Item	Model Number	Dimensions	Weight
FTS Module (for C6)	FTS-01	67×41×13 mm	13.9 g

[1] Not included in the original package. Please be careful not to exceed MTOM.

### List of Spare and Replacement Parts

DJI Matrice 4D Series Low-Noise Anti-Ice Propellers (Model: 1364F)

DJI Matrice 4D Series Battery (Model: BPX230-6768-22.14)

Refer to the Maintenance Manual for information on list of wearing parts.

## Remote Controller Warnings

The remote controller indicator will glow red after disconnecting from the aircraft. DJI FlightHub 2 will issue a warning prompt after disconnecting from the aircraft. The remote controller will beep and power off automatically after disconnecting from aircraft and with no operation for a long time.

- 
- ⚠️ • Avoid interference between the remote controller and other wireless equipment. Make sure to turn off the Wi-Fi on nearby mobile devices. Land the aircraft as soon as possible if there is interference.
  - Users are responsible for correctly adjusting the display brightness when using the monitor in direct sunlight during flight operation.
  - Release the control sticks or press the flight pause button if an unexpected operation occurs.
- 

## Direct Remote ID

1. Transport Method: Wi-Fi Beacon.
2. Method of uploading the UAS Operator Registration Number to the aircraft: Enter DJI Pilot 2 > **GEO Zone Map** > **UAS Remote Identification**, and then upload UAS Operator Registration Number.
3. According to applicable rules, operators shall provide the correct registration number to broadcast in flight. Please make sure you understand and comply with the rules.



## Geo Caging

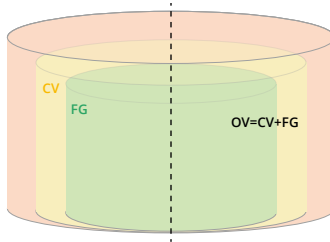

### Flight Geography (FG)

In this area, the aircraft can take off, perform flight tasks, and land. If the aircraft is approaching the FG edge, you will receive a voice alert and a warning message in .

### Contingency Volume (CV)

In this area, the aircraft cannot take off or land, and you cannot initiate automatic features such as RTH and FlyTo tasks. If the aircraft is approaching CV edge or flies into the CV, it will brake and hover. You will receive a voice alert and a warning message in . You can still control the aircraft to fly back to the FG.

### Operation Volume (OV)

OV include the FG and the CV. If the aircraft flies out of the OV, the Flight Termination System (FTS) will be automatically activated. You will receive a voice alert and a warning message in .

To ensure safe landing, the aircraft can still detect its current status and low-battery RTH, auto-landing, and landing protection are still available in the OV.

### Flight Termination System (FTS)

FTS will actively forces the aircraft to stop flying in case of emergencies. When FTS is activated, the aircraft propeller will stop and if installed, the parachute is activated.

## Using Geo Caging

1. The organization admin can open , click **My Organization** on the upper right corner, click  > **Edit**, and enable **GeoCaging**.

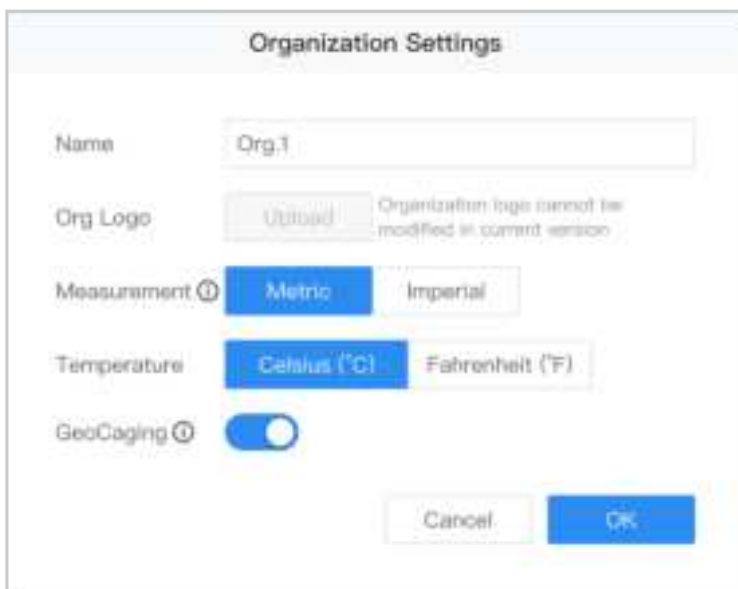

2. Open Project page, click > > **Action**, enable **Remote Debugging** > **Geo Caging**. You can modify the radius and altitude of the FG and the CV and the area will be displayed on the map.

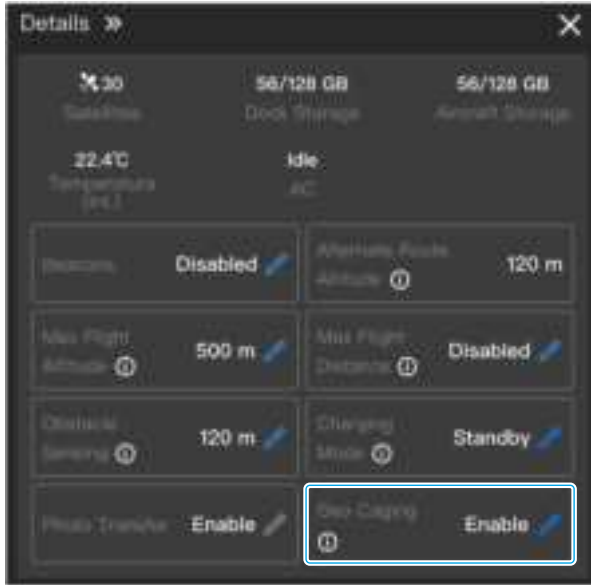







	FG	CV
Minimum Radius	100 m	FG radius + 100 m
Minimum Altitude	35 m	FG altitude + 35 m

The max configurable altitude of the GEO Caging is 1.5 km and the max configurable radius is 30 km. It is recommended to set a safe distance of at least 100 m between the FG and the CV. Refer to [Braking Distance in CV](#) for more information.

Altitude Definition: <https://fh.dji.com/user-manual/en/real-time-project-information/online-project-information.html>. The vertical altitude limit of the GEO Caging takes the height above take-off point (ATO) and only one vertical limit is available.

- ⚠ • Users can only modify the Geo Caging Settings when the aircraft is powered on and not performing any flight tasks.
  - Make sure that the FG altitude is higher than the RTH altitude of the aircraft.
  - Geo Caging does not conflict with the distance and altitude limits or the GEO Zones. The flight task will be limited if any of the restrictions is triggered.
- 
- 💡 • The accuracy of the map scale display at the bottom right corner is 100%. The following actions are available on the map:
    - View 📍 for the map orientation.

- Click  to enable the 3D map. Press and hold the Control/Ctrl key and left button of the mouse together to rotate the map.
- Click  to view GEO Zone information.
- Click  and the project point of interest will be displayed in the middle of the web page.
- Click  to view the map lab.
-  : Lock mode, the aircraft will be displayed in the center and the map view will change following the aircraft movement.
-  : Free mode, users can change the map view freely.
- Click  to display AirSense warnings.

### Display Warnings and Information

**Takeoff Warnings:** The aircraft cannot take off if the device or any task point is outside of the FG and will display a warning message.

When the Geo Caging is enabled, the device can check the running status of the Geo Caging function and monitor aircraft operation status in real time. If Geo Caging cannot function properly, will display a warning message and the aircraft cannot takeoff

### Braking Distance in CV

Considering the system response time of 0.02 s, if the aircraft flies out of the FG, the distance travelled during response time, and the horizontal and vertical braking distances are as follow:

	Conditions	Distance Travelled	Braking Distance
Worst-case (horizontal)	<ul style="list-style-type: none"> <li>• Flying perpendicular to FG</li> <li>• Flying at maximum horizontal flight speed</li> <li>• With a maximum wind speed resistance</li> <li>• Wind blowing perpendicular to FG in the flight direction</li> <li>• With a net weight</li> <li>• With a maximum takeoff weight</li> </ul>	Approx. 0.3 m	Approx. 26 m
Typical (horizontal)	<ul style="list-style-type: none"> <li>• Flying perpendicular to FG</li> <li>• Flying at average flight speed</li> <li>• With a net weight</li> <li>• Without wind</li> </ul>	Approx. 0.1 m	Approx. 20 m

	Conditions	Distance Travelled	Braking Distance
Worst-case (vertical)	<ul style="list-style-type: none"> <li>Flying at maximum ascend or descend speed</li> <li>With a maximum vertical wind speed in direction of flight</li> <li>With a net weight</li> <li>With a maximum takeoff weight</li> </ul>	Approx. 0.16 m	Approx. 4 m
Typical (vertical)	<ul style="list-style-type: none"> <li>Flying at average flight speed</li> <li>Ascending or descending at nominal speed</li> <li>With a net weight</li> <li>Without wind</li> </ul>	Approx. 0.5 m	Approx. 2 m

\* The detailed information on the above conditions can be found in <https://enterprise.dji.com/dock-3/specs>.

- The standard deviation of GNSS:  $\pm 10$  m (vertical) and  $\pm 10$  m (horizontal).
- The aircraft hovering and flight accuracy range with RTK positioning in windless or breezy conditions:  $\pm 0.1$  m (vertical) and  $\pm 0.1$  m (horizontal).
- The maximum deviation between the aircraft location displayed on DJI FlightHub 2 and the actual location: 5 m.

## Flight Termination System (FTS)

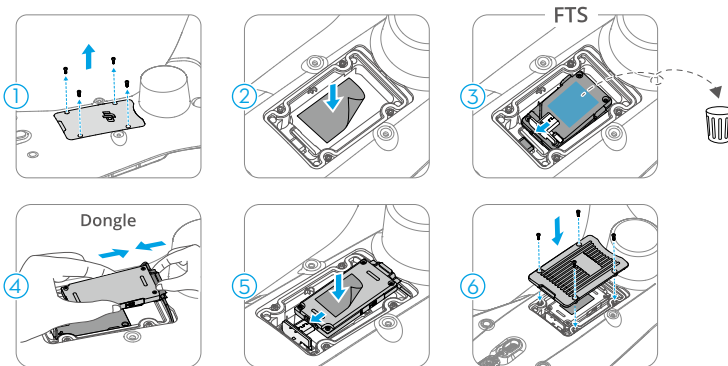

### Installation



1. Power off the aircraft. Loosen the screws and remove the compartment cover.
2. Place the thermal pad in the compartment.

3. Connect the FTS module to the USB-C connector in the compartment with the adhesive ilm facing up, and remove the adhesive ilm.
4. Connect the DJI Cellular Dongle 2 to the antennas in the compartment with the DJI logo facing down.
5. Put the dongle on the FTS module, insert the USB-C connector of the FTS module to the USB-C port of the dongle. Place the thermal pad on the dongle.
6. Install the metal cover and tighten the screws.

### Trigger Method

- FTS will be automatically triggered when Geo Caging is enabled and the aircraft flies out of the OV.
- Manually trigger FTS when the GNSS signal is weak or based on user's judgement:
  - ♦ In DJI FlightHub 2: Go to Devices page and click . Go to Aircraft Control, and click  of the FTS. Verify the device and slide **Terminate**.



Users can also scan the QR code shared on DJI FlightHub 2 with a mobile phone and verify the device to trigger FTS.

- ♦ In DJI Pilot 2: Make sure the aircraft and remote controller are linked. Enter Camera View, tap **•••** > **About** to find the FTS information. Then go the address [https://fh.dji.com/fts/index.html/#/](https://fh.dji.com/fts/index.html#/) and verify the device to trigger FTS.

## Testing Procedure

FTS testing must be done before the first flight:

1. Power on the aircraft.
2. Perform the Combination Stick Command (CSC) to start the motors. Once the motors have started spinning, release both sticks simultaneously.

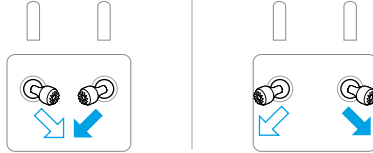

3. Manually trigger the FTS.
4. The motors stop after triggering the FTS, indicating the FTS testing is successful.

## Post Inspection

If FTS is triggered, parts inspection, cleaning, and replacement are required after the FTS procedure. Refer to the Maintenance Manual for more information.

## Risk and Warnings

The FTS Module needs to be used with the DJI Cellular Dongle 2. Make sure to operate in areas with good 4G signal. There will be a warning prompt after the FTS signal is lost for more than 120 s. The system will try to recover the signal every 500 ms after loss of signal. Check the internet connection of the dongle and try to resume internet connection.

- 
-  There is no operational distance limit between the FTS module and the aircraft. The aircraft can be controlled via the FTS module in areas with good 4G signal.
- 

## Distance Travelled

The Distances Travelled ( $D$ , measured in m) when the flight termination is activated at different Aircraft Altitude ( $A$ , measured in m):

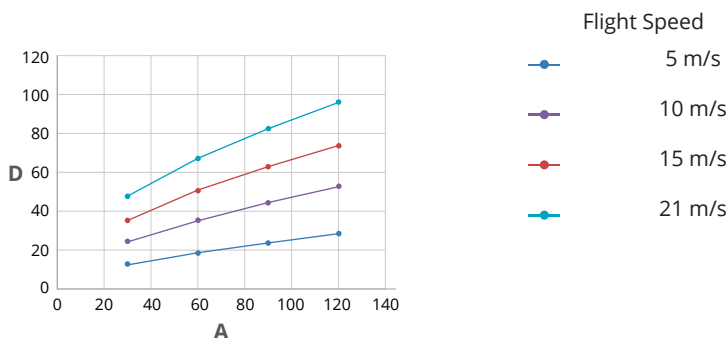

\* The distances are applicable if no parachute is installed and if the wind has no drag effect on the aircraft during the fall.

## EASA Notice

Make sure to read the Drone Information Notices document included in the package before use.

Visit the link below for more EASA notice information on traceability.

<https://www.easa.europa.eu/en/document-library/general-publications/drones-information-notices>

## Original Instructions

This manual is provided by SZ DJI Technology, Inc., and the content is subject to change.

Address: Lobby of T2, DJI Sky City, No. 53 Xianyuan Road, Xili Community, Xili Street, Nanshan District, Shenzhen, China, 518055.

## 6.8 FAR Remote ID Compliance Information

The unmanned aircraft system is equipped with a Remote ID system that meets the requirements of 14 CFR Part 89.

- The aircraft automatically initiates a pre-flight self-test (PFST) of the Remote ID system before takeoff and cannot take off if it does not pass the PFST <sup>(1)</sup>. The results of the PFST of the Remote ID system can be viewed in a DJI flight control app such as DJI Pilot 2 or in a DJI cloud platform such as DJI FlightHub 2.
- The aircraft monitors the Remote ID system functionality from pre-flight to shut down. If the Remote ID system malfunctions or has a failure, an alarm will be displayed in a



DJI flight control app such as DJI Pilot 2 or in a DJI cloud platform such as DJI FlightHub 2.

- The user shall keep the DJI flight control app running in the foreground and always allow it to obtain the location information of the remote controller when using the DJI flight control app to fly the aircraft.
- Developers who develop third-party applications based on the DJI Mobile SDK shall obtain and display the PFST results and the failure status of the Remote ID system during operation by calling specific APIs. <sup>[2]</sup>
- Developers who develop third-party platforms based on the DJI Cloud API shall obtain and display the PFST results and the failure status of the Remote ID system during operation by calling specific APIs. <sup>[3]</sup>
- You can visit the official website of FAA to learn more about aircraft registration and Remote ID requirements.

#### Footnotes

- [1] The pass criterion for PFST is that the hardware and software of the Remote ID required-data source and transmitter radio in the Remote ID system are functioning properly.
- [2] For detailed APIs information, please visit <https://developer.dji.com/mobile-sdk/>
- [3] For detailed APIs information, please visit <https://developer.dji.com/cloud-api/>

WE ARE HERE FOR YOU



Contact  
DJI SUPPORT



The terms HDMI, HDMI High-Definition Multimedia Interface, HDMI trade dress and the HDMI Logos are trademarks or registered trademarks of HDMI Licensing Administrator, Inc.

The content is subject to change without prior notice.

Download the latest version from



<https://enterprise.dji.com/dock-3/downloads>

If you have any questions about this document, contact DJI by sending a message to [DocSupport@dji.com](mailto:DocSupport@dji.com).

DJI and MATRICE are trademarks of DJI.  
Copyright © 2025 DJI All Rights Reserved.