

eeese
air care

User manual
Dehumidifier Adam

Art. 2509



Thank you for choosing this product.
Please read this instruction manual before using it.



Read the user manual before any use, refer to the corresponding section in this user manual.



Recycle unwanted materials instead of disposing of them. All appliances and packaging should be sorted and tendered at a regional recycling centre and be processed in an ecological manner.



The product conforms to the applicable European and other directives.



This unit uses a flammable refrigerant. If refrigerant leaks and comes in contact with fire or heating part, it will create harmful gas and there is risk of fire.

Table of Contents

1. Safety Instructions	72
2. Parts List	74
3. Prior to Operation	76
4. Continuous Drainage	76
5. Operation Instructions	77
6. Cleaning	80
7. Storage	81
8. Display Error Codes	82
9. Trouble Shooting	82
10. Technical Specifications	83
11. Smart Connection Operation Guide	84
12. Service	87
13. Warranty	87

1. Safety Instructions

Warning

This appliance is intended for use in a domestic environment only. Any other use is not recommended by the manufacturer and may cause fire, electrical shocks or other person injury and property damage.



Cautions



Wet hands not allowed



Warning

Power Cord

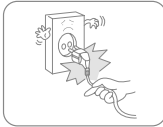

Do not pull the power cord in order to unplug the device from the socket.

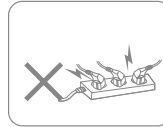

Do not use the appliance in overloaded extension cord.

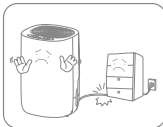

Do not put any heavy objects on the power cord in order to avoid safety hazard.

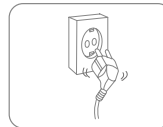

Do not use the appliance if its socket holes cannot firmly hold a plug.



Do not attempt to change the power cord, contact the authorized service centre for repair.



Do not touch the plug with wet hands in order to avoid electric shock.

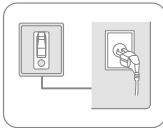

The socket has to be earthed and appropriately secured.

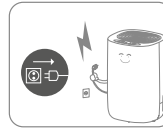

Please pull out the plug during lightning storms.

Placement



Do not put flammable and explosive objects around the appliance in order to avoid fire.

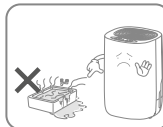

Do not use the appliance in swimming pool or similar facilities in order to avoid safety hazard.

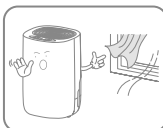

Do not use the appliance in a draughty place.



Place the appliance on a stable, flat surface.

During Use

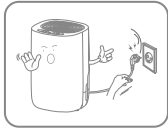

Please turn off the power and unplug the power cord before moving it.



Do not pour water into the appliance in order to avoid malfunction.



Children should be supervised to ensure that they do not place stick into the appliance.



Do not put any heavy objects on the appliance in order to avoid malfunction.



Do not push the appliance over or let the appliance suffer strong impact in order to avoid malfunction.



The appliance must not be covered when being used.



Do not put hands on the air outlet in order to avoid injury or malfunction.

2. Parts List

Components

1. Control Panel
2. Handle
3. Air Inlet Grille
4. Drainage Outlet
5. Casters
6. Air Outlet
7. Rear Cover
8. Power Cord
9. Top Cover
10. Front Cover
11. Water Tank

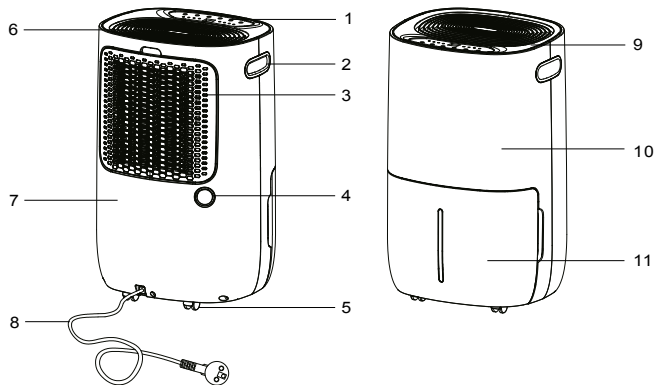

Control panel

- 12. Power button
- 13. Timer Off button
- 14. Up and Down Buttons
- 15. Fan speed button/
Child lock button
- 16. Mode button
- 17. Manual Indicator
- 18. Laundry drying Indicator
- 19. High Fan Speed Indicator
- 20. Low Fan Speed Indicator
- 21. Humidity Reading Display
- 22. Timer Indicator
- 23. Tank Full Indicator
- 24. Defrost Indicator
- 25. On/Off Indicator

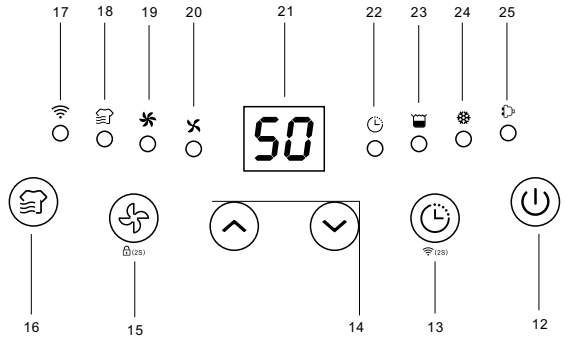

Drainage

- 26. Drainage outlet
- 27. Drainage pipe
(not included)

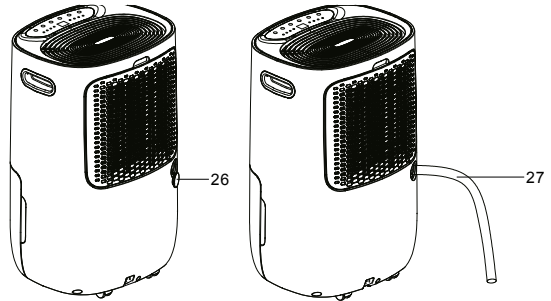

3. Prior to Operation

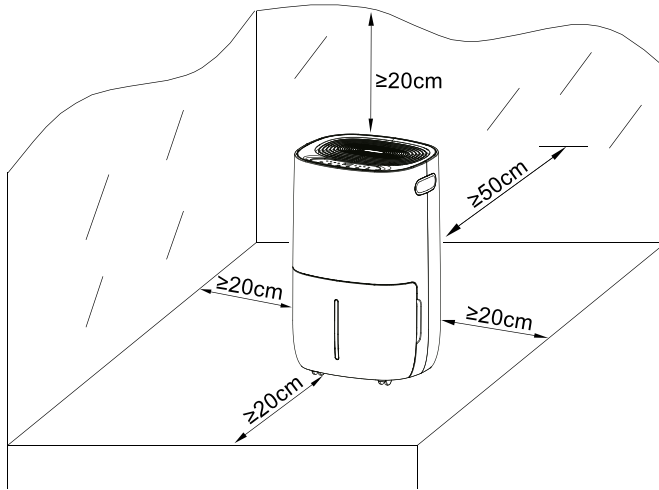

- Place the dehumidifier in an upright position on a stable, flat surface.
- Ensure the dehumidifier is at a safe distance at least 50 cm away from a wall or furniture.
- Supply power should be in correspondence with the value on the nameplate, power outlet needs to be grounded.
- Ensure the tank is correctly fitted, if the tank is full or not in place, the tank full light comes on and the dehumidifier will stop working.
- Turn on the power and run the machine as per instructions below.

4. Continuous Drainage

In general, water will be collected by tank, if you want continuous drainage, please do steps as follows:

- Remove the water tank.
- Mount a drainage hose (14mm inner diameter) to the drainage outlet.
- Put the water tank back in place.



Please always make sure the hose is going downhill, and is not blocked or kinked.

5. Operation Instructions

Switch On / Switch Off The Unit [Power button]

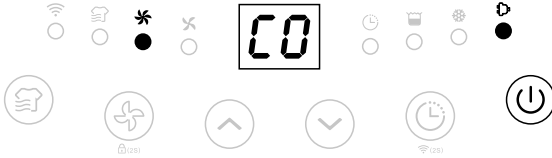

Connect to the power supply and press the power button once to turn on the unit. By default mode the unit runs on manual continuous dehumidifying with high fan speed. The on/off indicator will be on.



Press the power button to turn off the unit, it will stop working, fan will work for some seconds to blow out the hot air inside the unit.

When the machine is in standby mode, the on/off indicator will flash slowly.

Auto Shut-off Timer Function [Timer button]

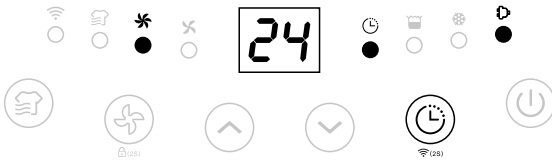

Press the timer button to select your preferred timer hour from 00-24-00 for automatic shut off setting by each press.



Auto timer off setting will be cancelled if the timer button is pressed 2 times in 3 seconds.

Auto timer off setting will be cancelled if the unit is switched off and switch on again.

Humidity Setting [Up and Down buttons]

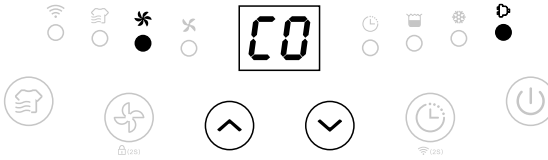

Press the up/down buttons to select your preferred humidity from CO-30%-35%-40%-45%-50%-55%-60%-65%-70%-75%-80%-CO. CO means continuous dehumidifying regardless of ambient humidity.

When the humidity in the room falls below the set value, the dehumidifier automatically turns off. The dehumidifier automatically restarts when the humidity exceeds the set value.

Fan Speed Option [Fan Speed button]

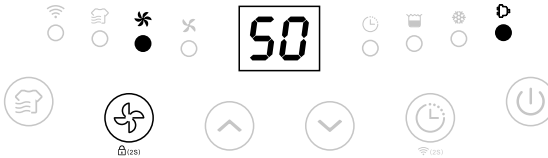

Press the fan speed button to select your preferred fan speed setting of low and high to meet the different usage requirements.



Fan speed button is invalid at Laundry drying mode and Defrost mode.

Laundry Drying Mode

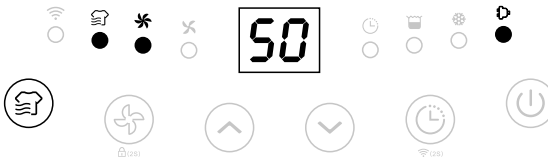

Press the mode button once to select Laundry Drying mode. The unit runs in continuous dehumidification with high fan speed for 6 hours then switch off automatically.

WiFi Function [Timer button-2 seconds]

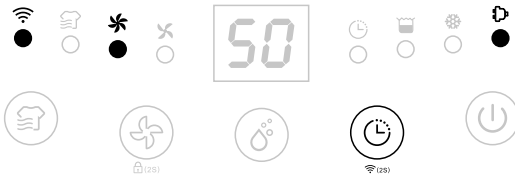

Press the Timer button for 2s to activate WiFi function and enter the distribution network mode, during the network configuration, the WiFi indicator flash quickly, after WiFi connected the indicator is on.



Detailed operation, please refer to the manual "Smart Connection Operation Guide".

Safety Childlock Function [Fan Speed button-2 seconds]

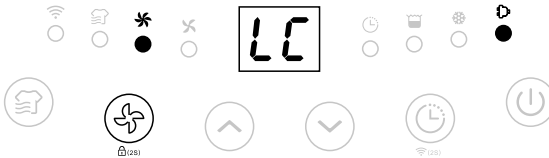

Press the Fan speed button for 2s to lock all buttons with a beeping sound, the same operation can unlock it.



Safety childlock function can be set at standby mode and working mode but can't be activated when water tank is full.

Low Temperature Defrost Indicator



When the ambient temperature is too low, the dehumidifier will enter into defrost mode, the unit runs with high fan speed without dehumidifying.

Auto Shut off with Water Tank Full Indicator

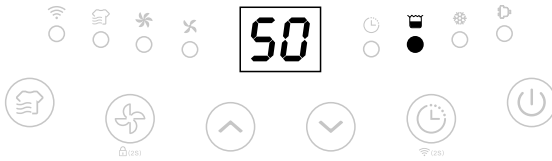

The unit will enter into standby mode when the water tank is full or when the water tank is not installed properly. After emptying the tank, or installing the water tank properly, the unit will go on to the previous mode.



Except for the power button, all other buttons are invalid.

Memory Function:

- When unplugged directly or power is cut, then reconnect to the power supply, the dehumidifier will run with the mode prior to the shutdown. The timer setting will be kept.
- Press the power button to switch off the dehumidifier, and then press the power button to switch it back on. The dehumidifier will run with the mode prior to the shutdown. The timer setting will be cancelled.
- Switch off the dehumidifier and unplug the power cord, then reconnect the power supply and switch on the dehumidifier. It will run in factory preset mode.

6. Cleaning

When used regularly, the filter may become clogged with dust and particles. Therefore the filter should be cleaned at least every two weeks. Follow these steps:

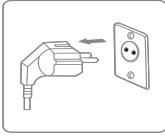
- 

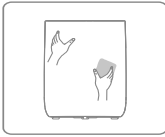
1. Switch the device off and remove the plug from the socket before cleaning.
- 

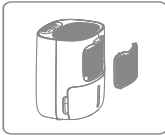
2. Clean the housing with soft, dry cloth. If the device is extremely dirty, use a mild cleaning agent. Wipe the dehumidifier with a slightly damp cloth. Never spray the device with water.
- 

3. Remove the grate, clean the filter with a vacuum cleaner or soapy water no hotter than 40°C.
- 

4. Rinse and dry the grate completely before installing back to the device.

7. Storage

If the dehumidifier will not be used for a long period of time, take the following steps:

14. Remove the plug from the socket and empty the tank, make sure the tank and the dehumidifier is completely dry. This may take a couple of days.
15. Clean the air filter.
16. Check the dehumidifier for perfect condition to ensure a safe use of it after a long period of storage.
17. Pack the device with the suitable packaging.
18. Store the dehumidifier in a dust-free location, and out of direct sunlight. Preferably covered with a sheet of plastic.

8. Display Error Codes

Please contact your local distributor if any of the error codes below appears.

Code	Error	Display	What is happening
E1	Temperature sensor error	Flash every 30 seconds	Device still dehumidifies but is in defrost mode only.
E2	Humidity sensor error	Flash every 30 seconds	Device still dehumidifies but is in continuous dehumidifying mode only.
L3	Air inlet temperature is too high >42°C	Slowly flash L3	Compressor stop working, fan works at low fan speed. 10mins later, if the temperature decrease to below 40 machine will work normally.
L4	Air inlet temperature is too low >0°C	Slowly flash L4	Compressor stop working, fan works at low fan speed. 10mins later, if the temperature increase to above 2 machine will work normally.

9. Trouble Shooting

Check the following before contacting technical support .

PROBLEM	POSSIBLE CAUSE	SOLUTION
The device does not work	The power is not connected	Insert the plug into the wall outlet
	The water tank is full	Empty the tank
	The tank has not been replaced correctly	Replace the tank
Water removal capacity is too low	Runtime is too short	Be patient and wait
	Ambient temperature or humidity is too low	It is normal that the device does not dehumidify in these conditions
The device works, but reduces the relative humidity insufficiently	The room is too big	We recommend using a dehumidifier with a greater capacity
	There is too much ventilation	Reduce ventilation (e.g. close windows and shut doors)
	The air filter is clogged	Clean the air filter
	Set humidity is higher than the ambient humidity	Set the humidity lower than ambient humidity
Dehumidifier is blowing out warm air	The dried air is passed over heating coils before it is blown into the room as part of the dehumidifying process	This is normal, a dehumidifier is not an air cooler

The display is not showing the humidity set point	The display shows the room relative humidity not the set point	Press the humidity control button once to see the target relative humidity
Water on floor	There is residual water in tank, and the device is lurched too much by moving	Be careful when moving the tank
The dehumidifier is noisy	The air filter is blocked or the device is on an uneven surface	Clean the filter or put the device on a flat surface

10. Technical Specifications

Model ADAM Art. no		2509
Recommended working area m ²		2-70
Timer		1 ~ 24 h
Power Supply		220-240V - 50Hz
Dehumidifying Capacity		20 L/day (30°C RH 80%)
		11.5 L/day (27°C RH 60%)
Power Consumption		255 W
Air Volume m ³ /h	High	145
	Low	130
Noise Level dB(A)	High	44
	Low	42
Water Tank Capacity		5 L
Operating Temperature		5~35°C
Refrigerant		R290
Compressor		Piston
Net Weight		15.2 kg
Filter		Washable
Drain Hose Diameter, mm		14
Drain hose included		No
Length of cable, cm		190
Product Size (WDH)		335 × 285 × 540 mm

The above technical data are for reference only. We reserve the right to modify them without notice.

11. Smart Connection Operation Guide

APP Binding Device

Search an APP platform for "TuyaSmart" or scan the following QR code to download the APP.



Step One

Make sure the phone is connected to the WIFI at home, and turn on the Bluetooth device, tap the upper right corner of the home page + to add device.

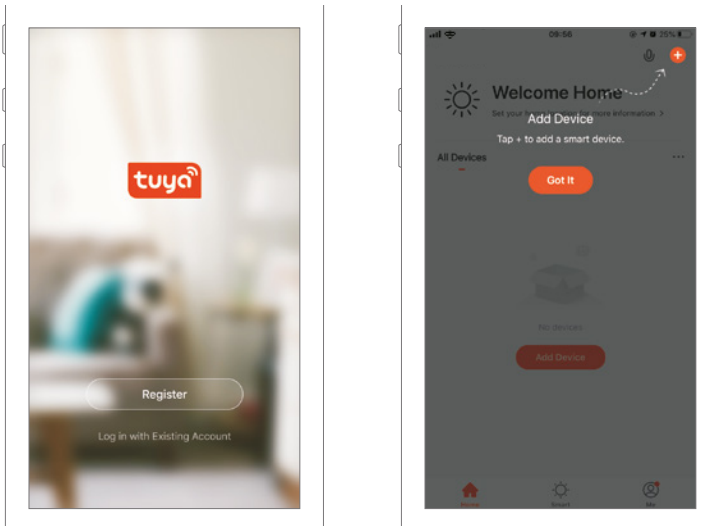

Step Two

Follow the instructions to select the device to be configured, and then enter the password for the wireless network which should be on 2.4 GHz.

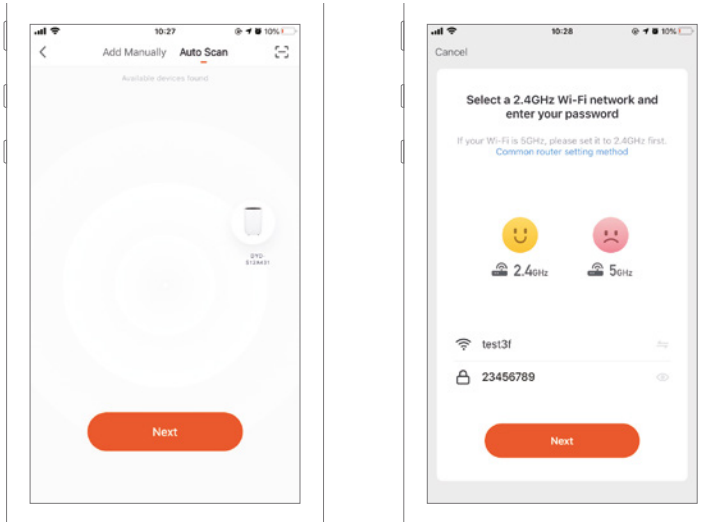

Step Three

Complete the connection to set the dehumidifier with APP.

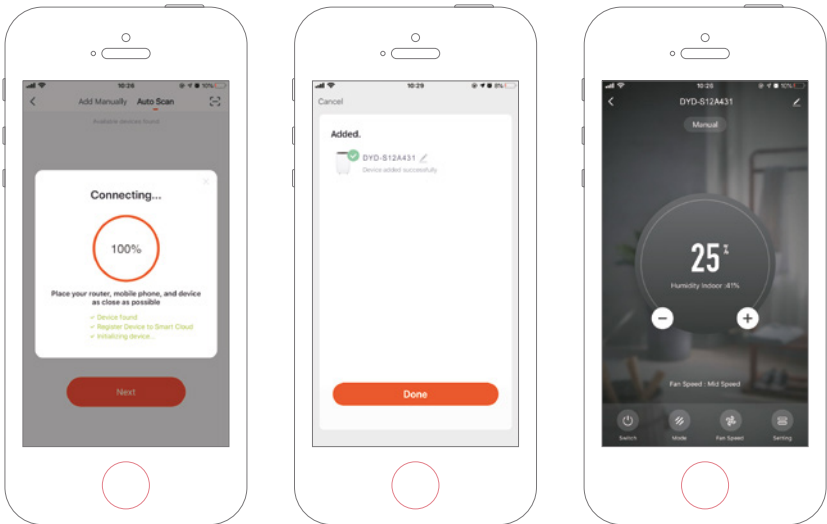

Adding Device Manually

Step One

Tap Add Device on the home page or + in the upper right corner to go to the Add Device page.

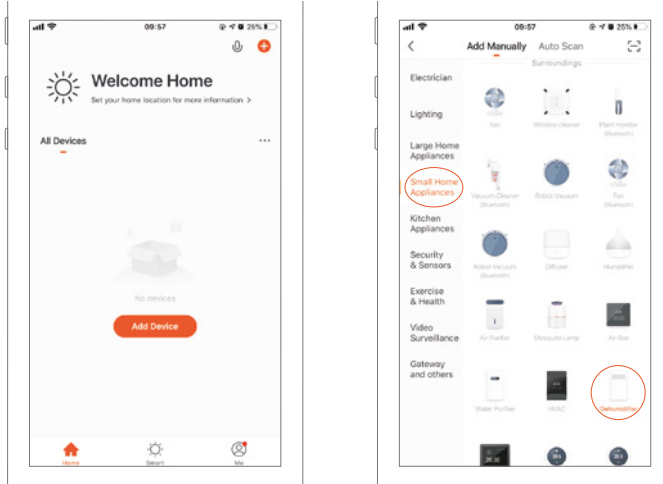

Step Two

Confirm the indicator rapidly blink and enter the WiFi password.

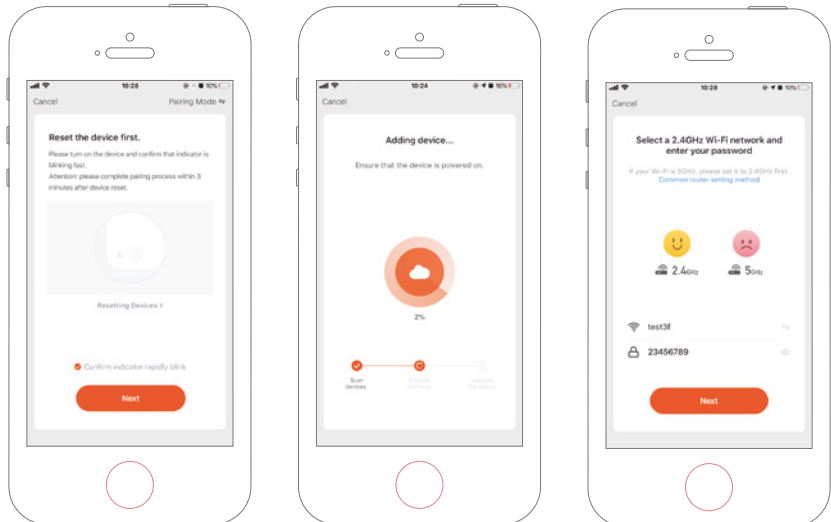

Step Three

Complete the connection to set the dehumidifier with APP.

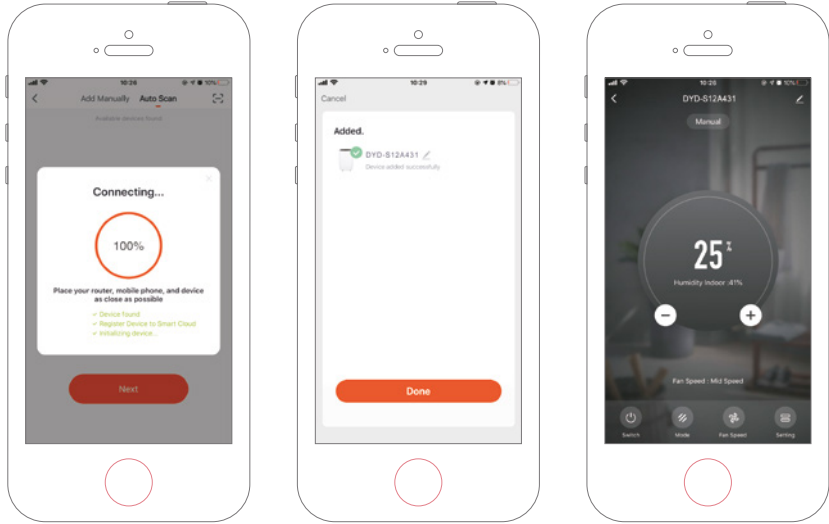

12. Service

If you need service or to make a warranty claim, you must create a case directly in our support system. Go to the website under SUPPORT.

<https://eeese-aircare.com/support>

13. Warranty

Limited warranty

We guarantee that all parts are free of defects in materials and workmanship for a period of two years from the date of purchase. The warranty covers only material or manufacturing defects that prevent the product from being able to be installed or operated in a normal way. Defective parts will be replaced or repaired.

The warranty does not cover transportation damage, any use other than what is intended, damage caused by incorrect assembly or improper use, damage caused by impact or other error, or by improper storage.

The warranty becomes void if the user modifies the product.

The warranty does not include product-related damage, property damage or general operational loss.

The manufacturer's liability cannot exceed the repair or replacement of defective parts and does not include labour costs to remove and reinstall the defective part, transportation costs to and from the service center, and all other materials necessary to carry out the repair.

This warranty does not cover failure or malfunction as a result of the following:

- Lack of proper installation, operation or maintenance of the unit in accordance with our published "User's Guide" supplied with the unit.
- The workmanship of any installation of the unit.
- Misuse, alteration, accident, fire, flood, lightning strike, rodents, insects, negligence or unforeseen events.
- Use of non-factory authorised parts or accessories in conjunction with the product.

Limitation of liability

This is the only warranty provided by the manufacturer. No one is authorised to make any other warranties on our behalf.

This warranty is in lieu of all other warranties, expressed or implied, including but not limited to any implied warranty of fitness for a particular purpose and saleability. We expressly disclaim all liability for consequential damage, accidental damage, indirect loss or loss related to a breach of the expressed or implied warranty.

This warranty gives you specific legal rights, which may vary by country.

Complaints

In the event of any warranty claim a valid purchase receipt must be presented. Read about raising a warranty-claim under the SERVICE section.

IMPORTANT!

If you need technical help – contact our customer service:

<https://eeese-aircare.com/support>

We have specialist knowledge of our products and the field in general, so you can get help quickly and easily.



Thank you for choosing this product.
Please read this instruction manual before using it.