

Instant Pot®

DUO™

MULTI-USE PRESSURE COOKER



User manual

Important safeguards

Products, parts
and accessories

Get started

Pressure cooking 101

Releasing pressure

Control panel

Pressure control features

Cooking

Care, cleaning and storage

Troubleshooting

Warranty

Contact

Register your product today at instantappliances.co.uk.

Download the Instant Pot App for 1000+ recipes at instantpot.com/app



IMPORTANT SAFEGUARDS



(Yes, we have to)

At Instant Brands™ your safety always comes first. The Instant Pot® Duo™ was designed with your safety in mind, and we mean business. Check out this Instant Pot's long list of safety mechanisms at instantpot.co.uk to see what we mean. As always, be careful when using electrical appliances and follow basic safety precautions.

- 01** READ THE GETTING STARTED GUIDE AND ALL INSTRUCTIONS, SAFEGUARDS AND WARNINGS BEFORE OPERATING THE APPLIANCE. FAILURE TO FOLLOW THESE SAFEGUARDS AND INSTRUCTIONS MAY RESULT IN INJURY AND/OR PROPERTY DAMAGE.
- 02** Using any other pressure cooker lids may cause injury and/or damage. The Instant Pot tempered glass lid, which can be purchased separately, may be used for non-pressure cooking.
- 03** Do not allow children near the pressure cooker when in use. Children should not play with the appliance. Use only the Instant Pot Duo lid with the Instant Pot Duo pressure cooker base.
- 04** Do not put the pressure cooker into a hot oven or on any heated surface.
- 05** Do not move the pressure cooker while under pressure.
- 06** Do not use the pressure cooker for any purpose other than that for which it is intended.
- 07** This appliance cooks under pressure. Scalds may result from inappropriate use of the pressure cooker. Make sure the cooker is properly closed before applying heat. Refer to the Getting Started Guide.
- 08** Never force open the pressure cooker. Do not open before making sure that its internal pressure has completely dropped. Refer to the Getting Started Guide.
- 09** Never use your pressure cooker without adding water as this would seriously damage it.
- 10** Do not fill the cooker beyond 2/3 of its capacity. When cooking foodstuffs which expand during cooking, such as rice or dehydrated vegetables, do not fill the cooker to more than 1/2 of its capacity.

WARNING

Read this manual carefully and completely and retain for future reference. Failure to adhere to safety instructions may result in serious injury or damage.

IMPORTANT SAFEGUARDS



- 11 When cooking doughy food, use caution when removing the lid to avoid food being ejected.
- 12 Use the appropriate heat source(s) according to the Getting Started Guide.
- 13 After cooking meat with a skin (such as ox tongue), which may swell under the effect of pressure, do not prick the meat while the skin is swollen as you may be scalded.
- 14 The heating element surface inside the Instant Pot base is subject to residual heat after use; do not touch.
- 15 Before each use, check that the valves are not obstructed. Refer to the Getting Started Guide.
- 16 Never use the pressure cooker in its pressurised mode for deep or shallow frying of food.
- 17 Do not tamper with any of the safety systems beyond the maintenance instructions specified in the instructions for use.
- 18 Only use Instant Pot spare parts and accessories in accordance with the relevant model. In particular, use a body and a lid from the same manufacturer indicated as being compatible.
- 19 Do not operate any appliance with a damaged lead or plug, or after the appliance malfunctions or has been damaged in any way. If the power supply lead is damaged, users should contact Customer Care for further assistance.
- 20 For domestic use only. Not intended for commercial or outdoor use.
- 21 Be aware that certain foods such as stewed apples, cranberries, pearl barley, oatmeal or other cereals, split peas, noodles, macaroni, rhubarb or spaghetti can foam, froth and clog the steam release. These foods should not be cooked under pressure cooking settings unless as directed in Instant Pot cooker recipes.

WARNING

Read this manual carefully and completely and retain for future reference.
Failure to adhere to safety instructions may result in serious injury or damage.

IMPORTANT SAFEGUARDS



- 22** This appliance should not be used by children, by individuals whose physical, sensory or mental abilities prevent safe use of the appliance, or by individuals with limited knowledge of how to use a pressure cooker. Close supervision is needed when using this appliance near these individuals.
- Spilled food can cause serious burns. A short power-supply lead is provided to reduce the hazards resulting from grabbing, entanglement and tripping.
- Keep the appliance and lead away from children.
 - Never drape the power lead over edges of tables or counters.
 - Never use below-counter power sockets, and never use with an extension lead.
- 23** Unplug your Instant Pot and let it cool before cleaning. Allow all surfaces to dry thoroughly before use.
- 24** The appliance is not intended to be operated by means of an external timer or a separate remote-control system.
- 25** Do not immerse the cooker base in water. To protect against electric shock, do not immerse the lead, power plug or cooker base in any liquid.
- 26** Always make sure the sealing ring is completely set in the groove on the inside of the sealing ring rack. Avoid spillage on the connector.

SAVE THESE INSTRUCTIONS.

Special lead set instructions

As per CE safety requirements, a short power supply lead is provided to reduce the hazards resulting from grabbing, entanglement and tripping.

This appliance has an earthed plug. To reduce the risk of electric shock, plug the power lead into an earthed and easily accessible electric socket.

WARNING





Read this manual carefully and completely and retain for future reference.
Failure to adhere to safety instructions may result in serious injury or damage.

IMPORTANT SAFEGUARDS



Product specifications

The tables below do not represent all models in the 7-in-1 Duo family.* To view a full list of sizes, colours and patterns, go to instantpot.co.uk/duo.

				
Duo mini v3	700 W	220-240V~50/60 Hz	3 Litres	3.9 kg
Duo 60 v4	1000 W	220-240V~50/60 Hz	5.7 Litres	5.44 kg
Duo 80 v3	1200 W	220-240V~50/60 Hz	8 Litres	7.16 kg

	Duo mini v3	Duo 60 v4	Duo 80 v3
	cm: 29 L x 25.5 W x 28.5 H	cm: 33.5 L x 31 W x 31.7 H	cm: 37.6 L x 33.8 W x 36.1 H

* Not all models and sizes are available in all countries.

Find your model name and serial number

Model name: Find it on the label on the back of the multicooker base, near the power lead.

Serial number: Turn the multicooker base over – you'll find this info on a sticker on the bottom.

WARNING

To avoid injury, read and understand the instructions in this user manual before attempting to use this appliance.

WARNING

Electric shock hazard. Use earthed socket only.

- DO NOT remove earthing.
- DO NOT use an adapter.
- DO NOT use an extension lead.

Failure to follow these instructions may result in electric shock and/or serious injury.

WARNING

THE FAILURE TO FOLLOW ANY OF THE IMPORTANT SAFEGUARDS AND/OR THE INSTRUCTIONS FOR SAFE USE IS A MISUSE OF YOUR APPLIANCE THAT CAN VOID YOUR WARRANTY AND CREATE THE RISK OF SERIOUS INJURY.

WARNING

Read this manual carefully and completely and retain for future reference. Failure to adhere to safety instructions may result in serious injury or damage.

Table of contents

IMPORTANT SAFEGUARDS	2
Special lead set instructions	4
Product specifications	5
Find your model name and serial number	5
Product, parts and accessories	8
Get started	10
Initial set up (It won't bite!)	10
Is anything missing or damaged?	10
Initial test run (water test)	11
Pressure cooking 101	12
Behind the magic curtain	12
Releasing pressure	13
Venting methods	13
Control panel	15
Settings	16
Status messages	18
Pressure control features (Your little bag of tricks!)	19
Pressure cooking lid	19
Steam release handle	20
Sealing ring	20
Float valve	21
Anti-block shield	21
Pressure cooking	22
Jump start magic!	23
Smart programme breakdown	24
Pressure cooking tips	26
Pressure cooking grains	28

Table of contents

Other cooking styles	29
Slow Cook	30
Sauté	31
Deglazing the inner pot (pressure cooking after sauté)	32
Yogurt	33
Using yogurt pots	34
Care, cleaning and storage	35
Removing and installing parts	36
Silicone sealing ring	36
Steam release handle	37
Anti-block shield	37
Float valve and silicone cap.....	38
Condensation collector.....	38
Troubleshooting	39
Warranty	42

Product, parts and accessories

Represents all Duo Mini, 5.7 and 8 litre models. See **Care, cleaning and storage: Removing and installing parts** to find out how everything fits together.

Top of lid

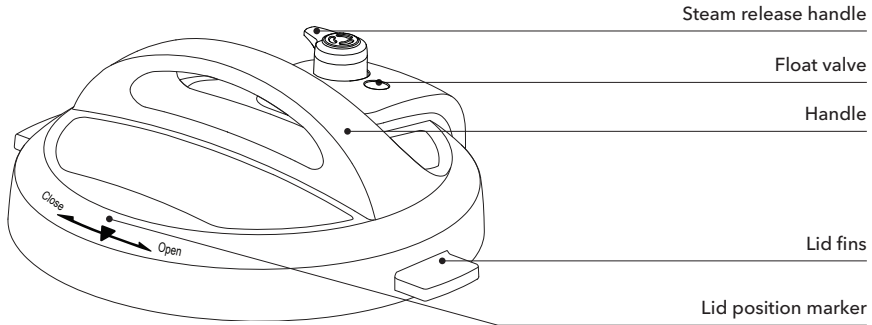

Bottom of lid

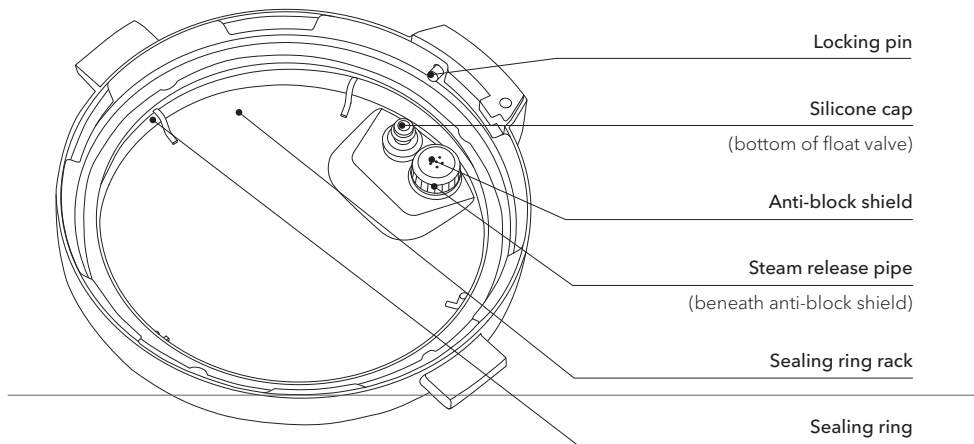

Stand the lid up in the multicooker base to keep it off your countertop! Insert the left or right lid fin into the corresponding slot in the multicooker base handles to stand it up and save some space.

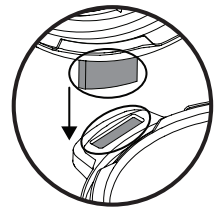

Illustrations in this document are for reference only and may differ from the actual product. Always refer to the actual product.

Product, parts and accessories

Inner pot

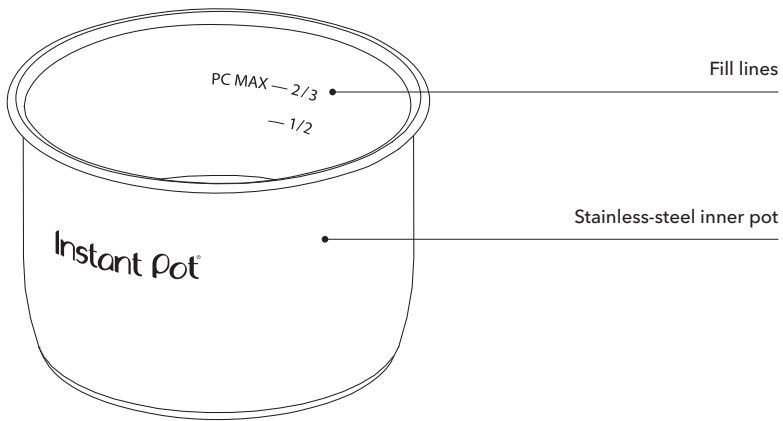

Multicooker base

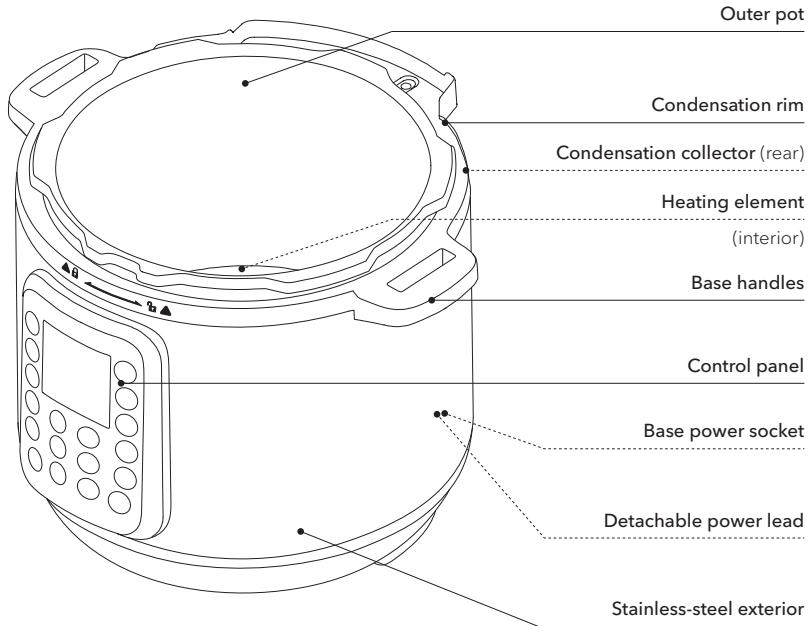

Illustrations in this document are for reference only and may differ from the actual product. Always refer to the actual product.

Get started



Initial set up (It won't bite!)

You – yes, you – can do this!



"This is my invariable advice to people: Learn how to cook – try new recipes, learn from your mistakes, be fearless, and above all have fun!"

- Julia Child

- 01** Take that Duo out of the box!
- 02** Remove all packaging material and accessories from in and around the multicooker.
 Check under the inner pot!
- 03** Wash the inner pot in a dishwasher or with hot water and washing up liquid. Rinse with warm, clear water and use a soft cloth to thoroughly dry the outside of the inner pot.
- 04** Wipe the heating element with a soft, dry cloth to make sure there are no stray packaging particles left in the multicooker base.
 Do not remove the safety warning stickers from the lid or the rating label from the back of the multicooker base.
- 05** You may be tempted to put the Duo on your hob – *but don't do it!*
Place the multicooker base on a stable, level surface, *away* from combustible material and external heat sources.

Is anything missing or damaged?

Get in touch with a Customer Care Advisor by email at support@instantpot.co.uk or by phone on **+44 (0) 3331 230051** and we'll happily make some magic happen for you!

Feeling keen?

- Check out **Product, parts and accessories** to get to know your Instant Pot's components, then read the **Pressure control features** for an in-depth look.
- While you're doing the **Initial test run (water test)**, read **Pressure cooking 101** to find out how the magic happens!

WARNING

Read the **Important safeguards** before using the appliance. Failure to read and follow those instructions for safe use may result in damage to the appliance, property damage or personal injury.

Do not place the appliance on a hob or on another appliance. Heat from an external source will damage the appliance.

Do not place anything on top of the appliance, and do not cover or block the steam release handle or anti-block shield, located on the appliance lid.

Get started

Initial test run (water test)

Do you *have* to do the water test? No – but getting to know the ins and outs of your Duo prepares you for success in the kitchen! Take a few minutes to get to know how this baby works.

Stage 1: Setting up the Duo for pressure cooking

01 Remove the inner pot from the multicooker base and add 3 cups (750 mL) of water to the inner pot, then place it back inside the multicooker base.

02 Secure the power lead to the base power socket at the back of the multicooker base. Make sure the connection is tight.

Connect the power lead to a 220–240V power source.

The display shows **OFF**.

03 Place and close the lid as described in **Pressure control features: Pressure cooking lid**.

04 Turn the steam release handle to the **Sealing** position.

Stage 2: "Cooking" (...hot water à la king, anyone?)

01 Select **Pressure Cook**.

02 Use the **- / +** buttons to adjust the cooking time to 5 minutes (**00:05**).

 Adjustments are saved when a Smart Programme starts, so the next time you use Pressure Cook, it will default to 5 minutes.

03 Press **Keep Warm** to turn the automatic Keep Warm setting off.

04 The multicooker beeps after 10 seconds and the display shows **On**.

 While the multicooker does its thing, read **Pressure cooking 101** on the next page to find out how the magic happens.

05 When the Smart Programme is complete, the display shows **End**.

Stage 3: Releasing pressure

01 Follow instructions for a Quick Release in **Releasing pressure: Venting methods**.

02 Wait for the float valve to drop, then carefully open and remove the lid as described in **Pressure control features: Pressure cooking lid**.

03 Using proper hand protection, remove the inner pot from the multicooker base, discard the water and thoroughly dry the inner pot.

That's it! You're good to go :)

CAUTION

Pressurised steam is released through the top of the steam release handle. Keep exposed skin away from the steam release handle.

DANGER

DO NOT attempt to remove the lid while the float valve is up and NEVER attempt to force the lid open. Contents are under extreme pressure. Float valve must be down before attempting to remove the lid. Failure to follow these instructions may result in serious personal injury and/or property damage.

CAUTION

The inner pot will be hot after cooking. Always use appropriate heat protection when handling a hot inner pot.

Pressure cooking 101

Pressure cooking uses steam to raise the boiling point of water above 100°C/212°F. These high temperatures allow you to cook food much faster than normal.

Behind the magic curtain

When pressure cooking, the Instant Pot goes through 3 stages.

Pre-heating

What you see	What you don't see	Tips
The display shows On .	While the multicooker pre-heats, it vaporises liquid to create steam. Once enough steam has built up, the float valve pops up and locks the lid in place.	The time it takes for the multicooker to pressurise depends on things like food and liquid temperature and volume. Frozen foods have the longest pre-heating time. For the fastest results, thaw your food before cooking it. No need to hang around during this stage – trust that IP magic!

Cooking

What you see	What you don't see	Tips
The float valve bobs up and down from all the steam, then pops up and stays flush with the lid. The display switches to the cooking countdown timer.	When it reaches the required pressure level, cooking begins. The Instant Pot automatically maintains the cooking pressure at High or Low pressure.	A higher pressure means a higher temperature. Smart Programme settings (e.g., cooking time, pressure level, etc.) can be adjusted at any time during cooking.

Releasing pressure

What you see	What you don't see	Tips
If Keep Warm is on after cooking, the timer counts up from 00:00 . If not, the multicooker goes back to standby and the display shows End . The float valve is still popped up.	Although food has finished cooking, the multicooker is still pressurised and hot, which is why the float valve is up. Releasing pressure lowers the temperature inside the multicooker, which allows you to safely remove the lid once the float valve has dropped.	See Releasing pressure for information on safe venting techniques and what they're used for. Follow your recipe instructions to choose the best venting method for your meal.  The Instant Pot cools faster if Keep Warm is turned off.

Releasing pressure

You **must** release pressure after pressure cooking before attempting to open the lid. Follow your recipe's instructions to choose a venting method, and always wait until the float valve drops into the lid before opening.

Venting methods

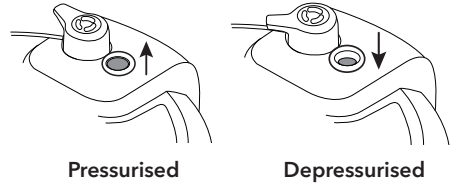

- Natural Release (NR or NPR)
- Quick Release (QR or QPR)
- Timed Natural Release



⚠ WARNING	
Steam ejected from the steam release handle is hot. DO NOT place hands, face or any exposed skin over the steam release handle when releasing pressure.	DO NOT cover the steam release handle.
⚠ DANGER	
DO NOT attempt to remove the lid while the float valve is up and NEVER attempt to force the lid open. Contents are under extreme pressure. Float valve must be down before attempting to remove the lid. Failure to follow these instructions may result in serious personal injury and/or property damage.	

Natural Release (NR or NPR)

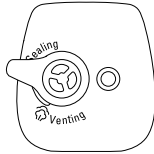
Cooking stops gradually. As the temperature within the multicooker drops, the Instant Pot depressurises naturally over time.

What to do	What to expect
<p>Once cooking is finished, leave the steam release handle in the Sealing position until all pressure is released.</p> <div style="text-align: center;">  <p>Sealing position</p> </div>	<p>Your meal continues to cook even after the Smart Programme has ended.</p> <hr/> <p> This is called “carryover cooking” or “resting”, and it’s great for large cuts of meat.</p> <p>The depressurisation time may vary based on the volume, type and temperature of food and liquid. It can take up to 40 minutes with some dishes, so plan ahead – it’s well worth the wait!</p> <p>When the pressure has been fully released, the float valve drops into the lid.</p>

Releasing pressure

NOTICE

Use NR to depressurise the multicooker after cooking high-starch foods (e.g., soups, stews, chilis, pasta, oatmeal and congee) or after cooking foods that expand when cooked (e.g., beans and grains).

Quick Release (QR or QPR)

Stops cooking quickly and prevents overcooking. Perfect for quick-cooking vegetables and delicate seafood!

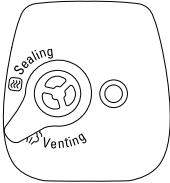
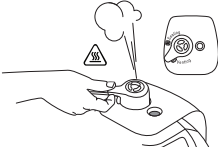
What to do	What to expect
<p>Carefully, quickly and confidently, turn the steam release handle to Venting and wait for all pressure inside the multicooker to be released.</p>  <p>Venting position</p>	<p>A jet of steam is ejected through the top of the steam release handle. This is normal!</p> <p>When the pressure has been fully released, the float valve drops into the lid.</p> 

Timed natural release

The carryover cooking continues for a specific amount of time, then stops quickly when you release the remaining pressure. Perfect for finishing rice and grains.

What to do	What to expect
<p>Leave the steam release handle in the Sealing position for a while (according to your recipe) then turn it to Venting and wait for all pressure inside the multicooker to be released.</p>	<p>A jet of steam is ejected through the top of the steam release handle.</p> <p>The temperature within the multicooker drops, so the steam release may not be as powerful as a normal QR.</p> <p> When the pressure has been fully released, the float valve drops into the lid.</p>

If there is substantial spatter while venting, turn the steam release handle back to **Sealing**. Wait a few minutes before trying to release pressure again. If spatter continues, use NR to safely release the remaining pressure.

Illustrations in this document are for reference only and may differ from the actual product. Always refer to the actual product.

⚠ CAUTION

Steam ejected from the steam release handle is hot. **DO NOT** place hands, face or any exposed skin over the steam release handle when releasing pressure.

⚠ NOTICE

Do not use QR when cooking fatty, oily, thick or high-starch foods (e.g., stews, chilis, pasta and congee) or when cooking foods that expand when cooked (e.g., beans and grains).

Control panel

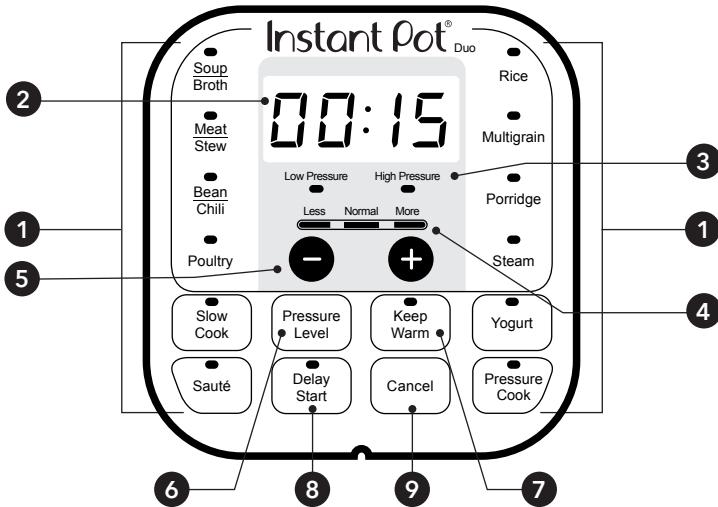



		Pressure cooking	Non-pressure cooking
1	Smart Programmes	<ul style="list-style-type: none"> • Soup/Broth • Meat/Stew • Bean/Chili • Poultry • Rice • Multigrain • Porridge • Steam • Pressure Cook 	<ul style="list-style-type: none"> • Slow Cook • Sauté • Yogurt • Keep Warm
2	Time display	Shows the time in HH:MM format. Counts up or down, depending on the Smart Programme.	
3	Pressure fields	LEDs show if the multicooker is using Low or High pressure during pressure cooking.	
4	Less / Normal / More	Pre-set cooking time or temperature levels, depending on the Smart Programme.	
5	- / + buttons	Adjust time for cooking, Delay Start and Keep Warm.	
6	Pressure level	Toggle between Low Pressure and High Pressure.	
7	Keep Warm	Turns the Keep Warm setting on or off.	
8	Delay Start	Delay the start of cooking.	
9	Cancel	Stop a Smart Programme at any time.	

Settings

Setting	Description
Turn sound on	When in standby, press and hold the + button until the display shows S On .
Turn sound off.	When in standby, press and hold the - button until the display shows SOFF .  Audible safety and error message alerts cannot be turned off.
Adjust and save custom cooking times and temperatures.	Once a Smart Programme has been selected, changes to the cooking time, temperature and pressure level are saved once the Smart Programme begins. See Cooking for details.
Reheat or warm for long periods.	Keep Warm can be used for up to a maximum of 10 hours (10:00). 01 When in standby, press Keep Warm . 02 Press Keep Warm again to cycle through Less , Normal and More warming temperature levels. 03 Use the - / + buttons to set a warming timer. 04 Keep Warm begins automatically after 10 seconds. When cooking thick or starchy foods, heat may not dissipate evenly. To ensure food safety, stir the contents of thicker dishes every 40 to 60 minutes. When Keep Warm is complete, the display shows End .

Settings

Setting	Description
<p>Set a Delay Start timer.</p>	<p>Delay Start can be set from between 10 minutes (00:10) and 24 hours (24:00).</p> <p>01 Select a Smart Programme and tweak it as needed, then press Delay Start.</p> <p> Once pressed, there is no way to go back to the Smart Programme settings. You'll have to press Cancel and start again.</p> <p>02 When the hours field flashes, use the - / + buttons to adjust the hours.</p> <p>03 Press Delay Start again to toggle to the minutes field and use the - / + buttons to adjust the minutes.</p> <p>04 The Delay Start timer starts automatically after 10 seconds.</p> <p>When Delay Start ends, the Smart Programme begins and the display shows On.</p> <p> Delay Start is not available with the Sauté or Yogurt Smart Programmes.</p>
<p>Reset an individual smart programme.</p>	<p>When in standby, press and hold one Smart Programme button until the multicooker returns to Standby and displays OFF.</p> <p>The Smart Programme's pressure level, cooking time and temperature are restored to the factory default setting.</p>
<p>Reset all smart programmes.</p>	<p>When in standby, press and hold Cancel until the multicooker beeps.</p> <p>All Smart Programme pressure levels, cooking times and temperatures are restored to the factory default setting.</p>

Status messages

OFF	The Instant Pot is in standby mode, ready for action!
Lid	May indicate that the lid is missing or is not properly secured.
On	The multicooker is pre-heating.
Auto	The Rice Smart Programme is running.
boil	The Yogurt Smart Programme is in the process of pasteurising milk (i.e., the Yogurt Smart Programme is set to More).
Hot	The inner pot has reached the perfect temperature and is ready to start cooking your food.  Only applies to Sauté.
00:00	Display shows one of the following: <ul style="list-style-type: none"> • When Delay Start is running, the multicooker counts down until the Smart Programme begins; • When a Smart Programme is running, the multicooker counts down the remaining cooking time; • When Keep Warm is running, the multicooker counts the length of time that food has been warming.
End	The Smart Programme has finished and Keep Warm is off.
Food burn	The multicooker is overheating due to insufficient liquid. See Troubleshooting for more information.

Can you see something else? See **Troubleshooting** for more information.

Pressure control features (Your little bag of tricks!)

See **Care, cleaning and storage** for installation and removal of parts.

Pressure cooking lid

What we love about it	What you should know about it
<p>The lid was designed with lid fins that fit perfectly inside the handles on the left and right sides of the multicooker base to help keep your countertop dry!</p> <p>When the Instant Pot is plugged in, it plays a little jingle when you open and close the lid.</p>	<p>The lid is removable during non-pressure cooking so you can taste-test as you go.</p> <p>When you're pressure cooking, the lid only locks into place once the multicooker is pressurised. Try not to remove the lid unnecessarily!</p>

Removing the lid

- 01** Grip the lid handle and turn it anti-clockwise to align the symbol on the lid ▼ with the symbol on the rim of the multicooker base ◀▶▲.
- 02** Lift the lid up and off the multicooker base towards your body.

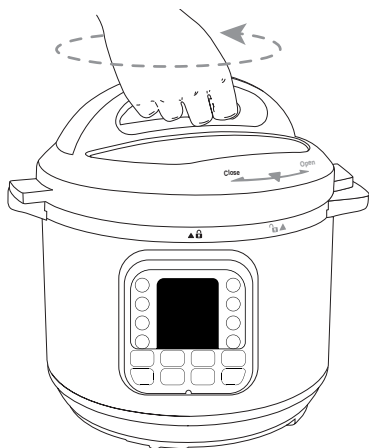

Closing the lid

- 01** Align the symbol on the lid ▼ with the symbol on the multicooker base ◀▶▲, then lower the lid onto the track.
- 02** Turn the lid clockwise until the symbol on the lid ▼ aligns with the symbol on the multicooker base ◀▶▲.

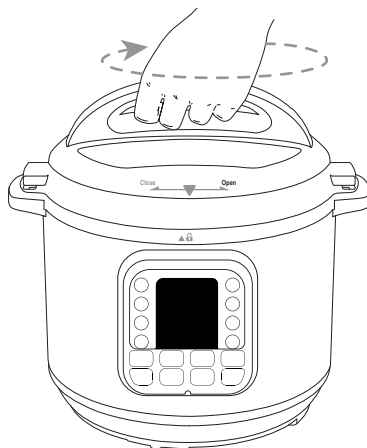

Illustrations in this document are for reference only and may differ from the actual product. Always refer to the actual product.

⚠ WARNING

Only use a compatible Instant Pot Duo lid with the Instant Pot Duo multicooker base. Using any other pressure cooker lids may cause injury and/or damage.



⚠ CAUTION

Always check the lid for damage and excessive wear prior to cooking.

Pressure control features

Steam release handle

The steam release handle controls the steam, venting it from the top of the steam release handle, or sealing it inside the Instant Pot.

What we love about it	What you should know about it
<p>It's easy to tell when the handle is in the Sealing or Venting position.</p> <div data-bbox="215 452 351 589"></div> <p data-bbox="219 594 359 614">Sealing position</p> <div data-bbox="462 452 597 589"></div> <p data-bbox="453 594 593 614">Venting position</p>	<p>The steam release handle sits loosely on the steam release pipe to pivot easily while under pressure, so it may feel a bit wobbly.</p> <p>This is normal!</p>

The steam release handle is integral to product safety and necessary for pressure cooking. It should be installed before use and cleaned regularly.

See **Releasing pressure** for safe venting methods and information on pressurisation and depressurisation.

⚠ WARNING

Do not cover or block the steam release handle in any way.

Sealing ring

When the pressure cooking lid is closed, the sealing ring creates an airtight seal between the lid and the inner pot.

The sealing ring must be installed before using the multicooker. Only one sealing ring should be installed in the lid at a time.

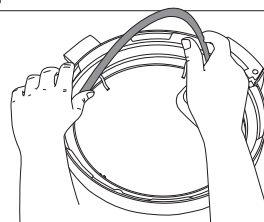

 Silicone is porous, so it absorbs strong aromas and certain flavours. Keep extra sealing rings on hand to limit the transfer of aromas and flavours between dishes.

⚠ CAUTION

Only use authorised Instant Pot sealing rings. **DO NOT** use a stretched or damaged sealing ring.

- Always check for cuts, deformation and correct installation of the sealing ring before cooking.
- Sealing rings stretch over time with normal use. The sealing ring should be replaced every 12–18 months or sooner if you notice stretching, deformation or damage.

Failure to follow these instructions may cause food to discharge, which may lead to personal injury or property damage.

Pressure control features

Float valve

The float valve is a visual indication of whether there is pressure in the multicooker (pressurised) or not (depressurised). It appears in two positions:

Pressurised

The float valve has visibly popped up and is flush with the lid.

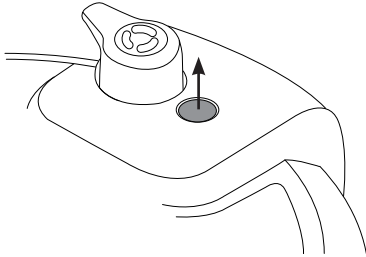

Depressurised

The float valve has dropped down into the lid.

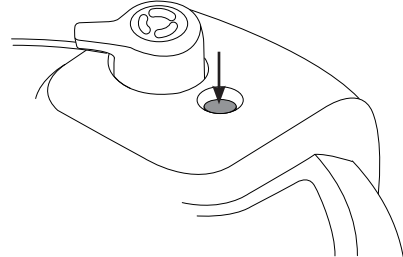

The float valve and silicone cap work together to seal in pressurised steam. These parts must be installed before use. Do not attempt to operate the Instant Pot without the float valve properly installed. **Do not touch the float valve during use.**

⚠ DANGER

DO NOT attempt to remove the lid while the float valve is up and NEVER attempt to force the lid open. Contents are under extreme pressure. Float valve must be down before attempting to remove the lid. Failure to follow these instructions may result in serious personal injury and/or property damage.

Anti-block shield

The anti-block shield prevents food particles from coming up through the steam release pipe, assisting with pressure regulation.

The anti-block shield is integral to product safety and necessary for pressure cooking.

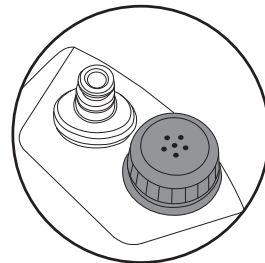

Illustrations in this document are for reference only and may differ from the actual product. Always refer to the actual product.

Pressure cooking

Whether you're a whiz in the kitchen or a complete newbie, these Smart Programmes help you get cooking at the touch of a button.

- Soup/Broth
- Meat/Stew
- Bean/Chili
- Poultry*
- Rice
- Multigrain*
- Porridge
- Steam
- Pressure Cook



*Not available on 3 Litre model.
Use Pressure Cook instead.

Using pressurised steam guarantees your dish is cooked evenly and deeply, for the delicious results you expect every time.

Pressure level	Suggested use	Notes
Low Pressure 5.8 – 7.2 psi (35–55 kPa)	Fish and seafood, soft vegetables and rice.	The pressure level controls the temperature, so a higher pressure results in a higher cooking temperature.
High Pressure 10.2 – 11.6 psi (65–85 kPa)	Eggs, meat, poultry, root vegetables, oats, beans, grains, bone broth, stew, chili.	

⚠ CAUTION

To avoid scorching or scalding injuries, be cautious when cooking with more than 60 mL of oil, oil-based sauces, condensed cream-based soups and thick sauces. Add suitable liquid to thin sauces. Avoid recipes that call for more than 60 mL of oil or fat content.

⚠ WARNING

Always cook with the inner pot in place. Food must be placed in the inner pot. **DO NOT pour food or liquid into the multicooker base.**

To avoid risk of personal injury and/or property damage, place food and liquid ingredients in the inner pot, then insert the inner pot into the multicooker base.

Do not fill inner pot higher than the **PC MAX — 2/3** (Pressure Cooking Maximum) line as indicated on the inner pot.

When cooking foods that **foam** or **froth** (e.g., stewed apples, cranberries or split peas) or **expand** (e.g., oats, rice, beans, pasta) do not fill the inner pot higher than the **— 1/2** line as indicated on the inner pot.

⚠ CAUTION

Always inspect the lid and inner pot carefully to make sure they are clean and in good working order before use.

- To avoid personal injury or damage to the appliance, replace the inner pot if it is dented, distorted or damaged.
- Use only authorised Instant Pot inner pots made for this model when cooking.

Always make sure the inner pot and heating element are clean and dry before inserting the inner pot into the multicooker base.

Failure to follow these instructions may damage the multicooker. Replace damaged parts to make sure it is safe to use.

Pressure cooking

To create steam, pressure cooking liquids should be water-based, such as broth, stock, soup or juice. If using tinned, condensed or cream-based soup, add water as directed below.

Instant pot size	Minimum liquid for pressure cooking
3 Litres	250 mL
5.7 Litres	375 mL
8 Litres	500 mL

**Unless otherwise specified by your recipe.*

Jump start magic!

Stage 1: Setting up the Duo for pressure cooking

- 01** Remove the inner pot from the multicooker base.
Add food and liquid ingredients to the inner pot, as directed by your recipe.
 Use the steam rack to keep foods out of the cooking liquid. This helps to distribute heat, prevents nutrients from leeching into the cooking liquid and stops food items from sticking to the bottom of the inner pot.
Insert the inner pot back into the multicooker base.
- 02** Secure the power lead to the base power socket at the back of the multicooker base. Make sure the connection is tight.
Connect the power lead to a 220–240V power source.
The display shows **OFF**.
- 03** Place and close the lid as described in **Pressure control features: pressure cooking lid**.
- 04** Turn the steam release handle to the **Sealing** position.

Stage 2: Pressure cooking

- 01** Select the Smart Programme you want to use.
- 02** Press the same Smart Programme button again to cycle through the pre-set time options in **Less**, **Normal** and **More**.
- 03** Use the **- / +** buttons to adjust the cooking time.
 Adjustments are saved to the Smart Programme when cooking begins.
- 04** Press **Pressure Level** to toggle between **Low Pressure** and **High Pressure**.
- 05** Leave the automatic Keep Warm setting on, or press **Keep Warm** to turn it off.
- 06** The multicooker beeps after 10 seconds and the display shows **On** as the multicooker preheats.
- 07** When the Smart Programme is complete, follow your recipe to select the appropriate venting method. See **Releasing pressure: Venting methods** for safe venting techniques.

DANGER

DO NOT attempt to remove the lid while the float valve is up and NEVER attempt to force the lid open. Contents are under extreme pressure. Float valve must be down before attempting to remove the lid. Failure to follow these instructions may result in serious personal injury and/or property damage.

Pressure cooking

Smart programme breakdown

Smart Programmes		Settings and defaults		
Soup/Broth	Pressure	Low (35-55 kPa / 5-8 psi) High (65-85 kPa / 9.4-12.3 psi)		
	Setting	Less	Normal	More
	Default cooking time (adjustable)	20 minutes (00:20)	30 minutes (00:30)	4 hours (04:00)
	Cooking time range	1 minute to 4 hours (00:01-04:00)		
Meat/Stew	Pressure	Low (35-55 kPa / 5-8 psi) High (65-85 kPa / 9.4-12.3 psi)		
	Setting	Less	Normal	More
	Default cooking time (adjustable)	20 minutes (00:20)	35 minutes (00:35)	45 minutes (00:45)
	Cooking time range	1 minute to 4 hours (00:01-04:00)		
Bean/Chili	Pressure	Low (35-55 kPa / 5-8 psi) High (65-85 kPa / 9.4-12.3 psi)		
	Setting	Less	Normal	More
	Default cooking time (adjustable)	25 minutes (00:25)	30 minutes (00:30)	40 minutes (00:40)
	Cooking time range	1 minute to 4 hours (00:01-04:00)		
Poultry*	Pressure	Low (35-55 kPa / 5-8 psi) High (65-85 kPa / 9.4-12.3 psi)		
	Setting	Less	Normal	More
	Default cooking time (adjustable)	5 minutes (00:05)	15 minutes (00:15)	30 minutes (00:30)
	Cooking time range	1 minute to 4 hours (00:01-04:00)		
Rice	Pressure	Low (35-55 kPa / 5-8 psi) High (65-85 kPa / 9.4-12.3 psi)		
	Setting	Less	Normal	More
	Default cooking time (adjustable)	8 minutes (00:08)	12 minutes (00:12)	15 minutes (00:15)
	Cooking time range	The cooking time adjusts automatically depending on the volume of rice: 8 to 15 minutes. Display shows Auto .		

Pressure cooking

Smart programme breakdown

Smart Programmes		Settings and defaults		
Multigrain*	Pressure	Low (35-55 kPa / 5-8 psi) High (65-85 kPa / 9.4-12.3 psi)		
	Setting	Less	Normal	More
	Default cooking time (adjustable)	20 minutes (00:20)	40 minutes (00:40)	1 hour (01:00) + 45 minutes soaking time
	Cooking time range	1 minute to 4 hours (00:01-04:00)		
Porridge	Pressure	Low (35-55 kPa / 5-8 psi) High (65-85 kPa / 9.4-12.3 psi)		
	Setting	Less	Normal	More
	Default cooking time (adjustable)	5 minutes (00:05)	20 minutes (00:20)	30 minutes (00:30)
	Cooking time range	1 minute to 4 hours (00:01-04:00)		
Steam	Pressure	Low (35-55 kPa / 5-8 psi) High (65-85 kPa / 9.4-12.3 psi)		
	Setting	Less	Normal	More
	Default cooking time (adjustable)	3 minutes (00:03)	10 minutes (00:10)	15 minutes (00:15)
	Cooking time range	1 minute to 4 hours (00:01-04:00)		
Pressure Cook	Pressure	Low (35-55 kPa / 5-8 psi) High (65-85 kPa / 9.4-12.3 psi)		
	Setting	Less	Normal	More
	Default cooking time (adjustable)	20 minutes (00:20)	35 minutes (00:35)	45 minutes (00:45)
	Cooking time range	1 minute to 4 hours (00:01-04:00)		

*Not available on 3 Litre models. Use Pressure Cook instead.

Pressure cooking

Pressure cooking tips

Smart Programme	Setting	What it's for	Tips
Soup/Broth	Less	Soup without meat.	Liquid remains clear due to lack of boiling motion. Always use NR to release pressure when cooking soup with a high starch content.
	Normal	Soup with meat.	
	More	Rich bone broth.	
Meat/Stew	Less	Soft texture.	Choose setting based on meat texture desired, or adjust cooking time manually. Allow meat to "rest" for 5-30 minutes, depending on size. It will retain cooking juices for tender, succulent meat.
	Normal	Very soft texture.	
	More	Fall-off-the-bone texture.	
Bean/Chili	Less	Firmer texture.	Choose setting based on desired bean texture, or adjust cooking time manually. When cooking beans or legumes, always use NR to release pressure. Make sure dry beans are completely submerged in water.
	Normal	Soft texture.	
	More	Very soft texture.	
Poultry*	Less	Soft texture.	Choose setting based on poultry texture desired or adjust cooking time manually. Allow poultry to "rest" for 5-30 minutes, depending on size. It will retain cooking juices for tender, succulent meat.
	Normal	Very soft texture.	
	More	Fall-off-the-bone texture.	

Pressure cooking

Pressure cooking tips

Smart Programme	Setting	What it's for	Tips
Rice	Less	Tender but firm to bite.	For cooking medium and long-grain white rice.
	Normal	Normal texture white rice.	Depending on the volume of rice, cooking time may range from 8-15 minutes.
	More	Softer texture white rice.	Use a 10-minute Natural Release after cooking for perfect results.
Multigrain*	Less	Brown rice, wild rice, black beans, chickpeas, etc.	Select Less or Normal based on type of grain and desired texture. More begins with 45 minutes of warm water soaking time prior to 60 minutes of pressure cooking.
	Normal	Brown rice, wild rice, mung beans, etc.	
	More	Tough grains or a mixture of grains and beans.	
Porridge	Less	Oatmeal—coarse or rolled.	Adjust time as directed in recipe. Always use NR to release pressure when cooking foods that expand.
	Normal	White rice, porridge or congee.	
	More	Rice, porridge or congee with a mixture of various grains.	

Pressure cooking

Smart Programme	Setting	What it's for	Tips
Steam	Less	Vegetables.	Use steam rack provided to elevate food from cooking liquid. Use QR to release pressure and prevent food from overcooking.
	Normal	Fish and Seafood.	
	More	Meat.	
Pressure Cook	NA	Manual programming.	Press Pressure Level to toggle between High and Low pressure. Use - / + buttons to adjust cooking time Adjust according to recipe or desired results.

* Not available on 3 Litre model. Use Pressure Cook instead.

Pressure cooking grains

Check out the **cooking timetables** for guidance or visit our **recipe site** for fun, easy-to-follow recipes with big crunch. You can also download the free **Instant Pot app** to search recipes, save favourites, make notes and more!

Rice and grain	Grain to water ratio
White or brown rice	1: 1
Quinoa	1: 3/4
Oatmeal	1: 3
Risotto	1: 2 Add additional wine to taste
Porridge	1: 10

CAUTION

Use a meat thermometer to ensure meat reaches a safe minimum internal temperature. Refer to the WHO (World Health Organization) **website** and/or review your local government's food safety recommendations for more information.

Other cooking styles

The Duo is much more than a pressure cooker. These Smart Programmes don't cook with pressure but are just as easy to use.

- Slow Cook
- Sauté
- Yogurt



Always inspect your Instant Pot pressure cooking lid, inner pot and multicooker base carefully to make sure they are clean and in good working order before use.

⚠ WARNING

Always cook with the inner pot in place. Food must be placed in the inner pot. **DO NOT pour food or liquid into the multicooker base.**

To avoid risk of personal injury and/or property damage, place food and liquid ingredients in the inner pot, then insert the inner pot into the multicooker base.

Do not fill inner pot higher than the **PC MAX** — **2/3** (Pressure Cooking Maximum) line as indicated on the inner pot.

When cooking foods that **foam or froth** (e.g., stewed apples, cranberries or split peas) or **expand** (e.g., oats, rice, beans, pasta) do not fill the inner pot higher than the — **1/2** line as indicated on the inner pot.

⚠ CAUTION

Always inspect the lid and inner pot carefully to make sure they are clean and in good working order before use.

- To avoid personal injury or damage to the appliance, replace the inner pot if it is dented, distorted or damaged.
 - Use only authorised Instant Pot inner pots made for this model when cooking.
- Always make sure the inner pot and heating element are clean and dry before inserting the inner pot into the multicooker base.

Failure to follow these instructions may damage the multicooker. Replace damaged parts to make sure it is safe to use.

Other cooking styles

Slow Cook

Slow Cook is compatible for use with any standard slow cooker recipe, so you can keep cooking your classics!

 The float valve should not rise during Slow Cook. The lid is removable throughout the cooking process for easy access. If the float valve rises, make sure the steam release handle is set to the **Venting** position. See **Pressure control features: Steam release handle**.

Setting	Suggested Use	Notes
Less	Low setting on standard slow cookers.	Less is commonly used for low and slow, all-day cooking and should be set for a minimum of 10 hours (10:00) for best results.
Normal	Medium setting on standard slow cookers.	
More	High setting on standard slow cookers.	You can use a glass lid for slow cooking if it has a venting hole.

Stage 1: Setting up the Duo for slow cooking

- 01** Remove the inner pot from the multicooker base.
Add food and liquid ingredients to the inner pot.
Insert the inner pot into the multicooker base.
- 02** Secure the power lead to the base power socket at the back of the multicooker base. Make sure the connection is tight.
Connect the power lead to a 220–240V power source.
The display shows **OFF**.
- 03** Place and close the lid as described in **Pressure control features: pressure cooking lid**, or use a glass lid with a venting hole.
- 04** Turn the steam release handle to the **Venting** position.

Stage 2: Slow cooking

- 01** Press **Slow Cook**.
- 02** Press **Slow Cook** again to cycle through the pre-set temperature options in **Less**, **Normal** and **More**.
- 03** Use the **- / +** buttons to adjust the cooking time.
 Cooking time and temperature level adjustments are saved to the Smart Programme when cooking begins.
- 04** Leave the automatic Keep Warm setting on, or press **Keep Warm** to turn it off.
- 05** After 10 seconds, cooking begins and the display timer counts down.
When cooking is complete, the display shows **End** if Keep Warm is turned off. If not, the timer begins counting from **00:00** up to 10 hours (**10:00**).

Other cooking styles

Sauté

Sauté can be used in place of a frying pan, griddle or flat-top grill.

Setting	Suggested Use	Notes
Less	Simmering, thickening and reducing liquids.	The display switching from Hot to On indicates that the multicooker is maintaining the cooking temperature. As a safety precaution, 30 minutes is the maximum cooking time.
Normal	Pan searing or sautéing.	
More	Stir-frying or browning meat.	

Stage 1: Setting up the Duo for sautéing

- 01** Insert the inner pot into the multicooker base. **Do not use a lid.**
 - 02** Secure the power lead to the base power socket at the back of the multicooker base. Make sure the connection is tight.

Connect the power lead to a 220–240V power source.
The display shows **OFF**.
 - 03** Press **Sauté**.
 - 04** Press **Sauté** again to cycle through the pre-set temperature options in **Less**, **Normal** and **More**.
 - 05** Use the **- / +** buttons to adjust the cooking time.

Cooking time and temperature level adjustments are saved to the Smart Programme when cooking begins.
-  After 10 seconds, the multicooker displays **On** to indicate that it has begun heating.

Stage 2: Sautéing

- 07** When the display switches from **On** to **Hot**, add ingredients as directed by your recipe.

 If recipe ingredients are added before the Hot message appears, it may not appear at all. This is normal!
- 08** If you finish sautéing before the timer runs out, press **Cancel**. Otherwise, when cooking is complete, the display shows **End**.

Delay Start and Automatic Keep Warm are not available on the Sauté Smart Programme.

Other cooking styles

Deglazing the inner pot (pressure cooking after sauté)

Sautéing meat and vegetables before pressure cooking is the perfect way to boost flavours, as sugars caramelize from the high heat of the Sauté Smart Programme.

When pressure cooking after using Sauté, deglaze the inner pot to make sure food items do not scorch.

To deglaze: Remove food items from the inner pot and add a thin liquid (e.g., water, broth, wine) to the hot surface. Use a wooden or silicone scraper to loosen anything that may be stuck to the bottom of the inner pot.

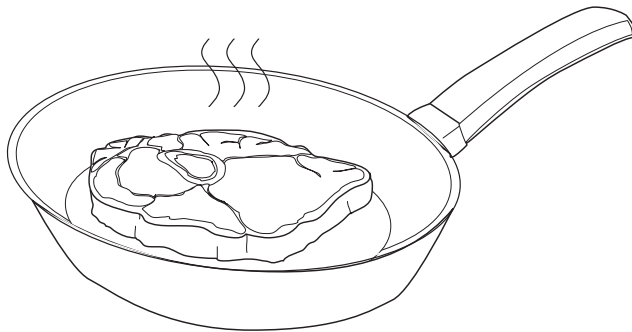

⚠ WARNING

The Sauté Smart Programme reaches high temperatures. If unmonitored, food may burn on this setting. Do not use the lid and do not leave your multicooker unattended while using Sauté.

Other cooking styles

Yogurt

Yogurt is designed to effortlessly produce delicious fermented dairy and non-dairy recipes.

Instant Pot Size	Minimum Milk Volume	Maximum Milk Volume
3 Litres	500 mL	1.9 L
5.7 Litres	1000 mL	3.8 L
8 Litres	1500 mL	5.8 L

Setting	Suggested Use	Notes
Less	For lower temperature fermentation (e.g., Jiu Niang, a sweet fermented glutinous rice dessert).	Default fermentation time is 24 hours (24:00) . Adjust fermentation time based on recipe.
Normal	Fermenting milk after culture has been added.	A longer fermentation will result in tangier yogurt. Adjust as desired up to 99 hours and 30 minutes (99:30).
More	Pasteurising milk.	Pasteurisation time is pre-set and cannot be adjusted. Display shows boiL while pasteurisation is running. For extra thick yogurt, pasteurise milk twice!

Stage 1: Pasteurise milk

- 01 Remove the inner pot from the multicooker base.
 - 02 Add unpasteurised milk to the inner pot then insert the inner pot into the multicooker base.
 - 03 Secure the power lead to the base power socket at the back of the multicooker base. Make sure the connection is tight.

Connect the power lead to a 220-240V power source.
The display shows **OFF**.
 - 04 Place and close the lid as described in **Pressure control features: pressure cooking lid**.
 - 05 Turn the steam release handle to the **Venting** position.
 - 06 Press **Yogurt**.
 - 07 Press **Yogurt** again and cycle to **More**. The display shows **boiL**.
 - 08 After 10 seconds the multicooker begins heating.
 - 09 When pasteurisation is complete, the display shows **End**.

Remove the lid and use a thermometer to check the temperature.
-  Milk must reach a minimum of 72°C for pasteurisation to occur.

Other cooking styles

Stage 2: Add starter culture

- 01** Allow pasteurised milk to cool to just below 43°C (110°F).
- 02** Add a starter culture to the milk according to package instructions.
 If using plain yogurt as a starter, make sure that it contains an **active culture**. Mix in 30 mL (2 tbsp) of yogurt per 3.7 L of milk, or follow a trusted recipe.
- 03** Place and close the lid as described in **Pressure control features: pressure cooking lid**.

Stage 3: Ferment yogurt

- 01** Press **Yogurt**.
- 02** Press **Yogurt** again and cycle to **Normal**. The display shows 8 hours (**08:00**).
- 03** Use the **- / +** buttons to adjust the fermentation time if desired.
 A longer fermentation period will give you tangier yogurt.
- 04** After 10 seconds the multicooker begins heating. The display timer counts up to the set time from **00:00**.
- 05** When fermentation is complete, the multicooker beeps and displays **End**.

 Allow the yogurt to cool, then place in your fridge for 12 to 24 hours to allow the flavours to develop!

Using yogurt pots

Yogurt pots are a convenient way to portion out yogurt servings.

- 01** After adding the starter culture to your pasteurised milk, carefully pour the milk into your yogurt pots and seal them tightly.
- 02** Clean the inner pot thoroughly and place the steam rack on the bottom of the inner pot.
- 03** Place the sealed yogurt pots on the steam rack and add water to the inner pot until the pots are half submerged.
- 04** Follow the steps in **Stage 3: Ferment Yogurt**.

Care, cleaning and storage

Clean your Duo and its parts after each use. Failure to follow these cleaning instructions may result in catastrophic failure, which may lead to property damage and/or severe personal injury.

Always unplug your multicooker and allow it to cool to room temperature before cleaning. Never use metal scouring pads, abrasive powders or harsh chemical detergents on any of the Instant Pot's parts or accessories.

Allow all surfaces to dry thoroughly before use and before storage.

Parts	Cleaning methods and instructions
Accessories <ul style="list-style-type: none"> • Steam rack 	Dishwasher safe if placed on the top rack.
Lid and parts <ul style="list-style-type: none"> • Condensation collector • Anti-block shield • Sealing ring • Steam release handle • Float valve • Silicone cap 	Dishwasher safe if placed on the top rack. Remove all the parts from the lid before cleaning. See Care, cleaning and storage: Removing and installing parts. <ul style="list-style-type: none"> • Check the condensation collector after each use and empty as needed. Do not allow food or moisture to stagnate in the condensation collector. • With steam release handle and anti-block shield removed, clean the interior of the steam release pipe to prevent clogging. • To drain water from the lid after dishwashing, take the lid handle and hold the lid vertically over a sink, then turn it 360°— like turning a steering wheel. • After cleaning, store the lid upside down on the multicooker base. • Store sealing rings in a well-ventilated area to decrease residual odour from highly-flavoured meals. To eliminate odours, add 250 mL water and 250 mL white vinegar to inner pot and run Pressure Cook for 5-10 minutes, then QR pressure.
Inner pot	Dishwasher safe. <ul style="list-style-type: none"> • Heavy hard water staining may require a vinegar dampened sponge and some scrubbing to remove. • If there is tough or burned food residue at the bottom, soak in hot water for a few hours for easy cleaning. • Make sure all exterior surfaces are dry before placing in multicooker base.
Power lead Detachable power lead	Hand wash only. Do not wash in a dishwasher. <ul style="list-style-type: none"> • Use a barely-damp cloth to wipe any particles off the lead.
Multicooker base	Hand wash only. Do not wash in a dishwasher. <ul style="list-style-type: none"> • Wipe the inside of the outer pot as well as the condensation rim with a barely damp cloth. Allow them to dry completely before inserting inner pot. • Clean multicooker base and control panel with a soft, barely damp cloth or sponge.

Some discolouration may occur after washing in a dishwasher, but this will not affect the cooker's safety or performance.

Care, cleaning and storage

⚠ WARNING

The Instant Pot multicooker base contains electrical components. To avoid fire, electrical leakage or personal injury, make sure the multicooker base stays dry.

- DO NOT immerse the multicooker base in water or other liquid, or attempt to run it through a dishwasher.
- DO NOT rinse the heating element.
- DO NOT submerge or rinse the power lead or plug.

Removing and installing parts

Silicone sealing ring

Remove the sealing ring

Grip the edge of the silicone and pull the sealing ring out from behind the circular stainless steel sealing ring rack.

With the sealing ring removed, inspect the steel rack to make sure it is secured, centred and an even height all the way around the lid. Do not attempt to repair a deformed sealing ring rack.

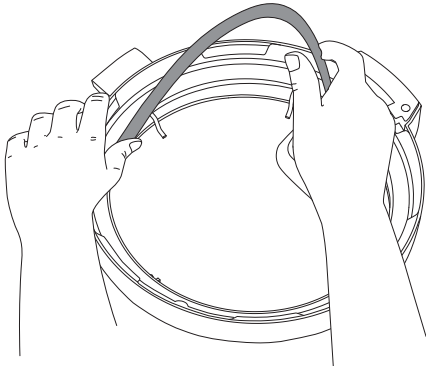

Install the sealing ring

Place the sealing ring over the sealing ring rack and press it into place. Press down firmly to prevent puckering.

When installed properly, the sealing ring is snug behind the sealing ring rack and should not fall out when the lid is turned over.

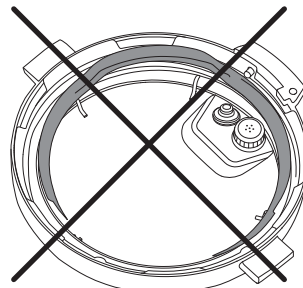
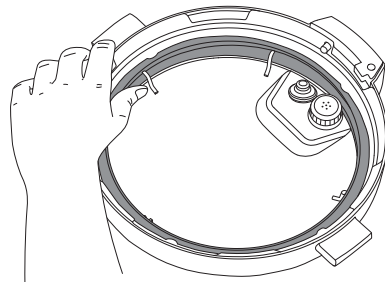

Incorrect

Illustrations in this document are for reference only and may differ from the actual product. Always refer to the actual product.

Care, cleaning and storage

Steam release handle

Remove the steam release handle

Pull the steam release handle up and off the steam release pipe.

The steam release handle must be installed before using the multicooker.

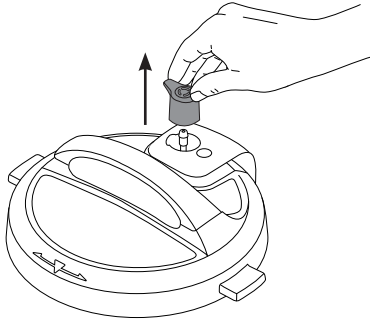

Install the steam release handle

Place the steam release handle on the steam release pipe and press down firmly.

The steam release handle sits loosely on the steam release pipe when installed properly but should remain in place when the lid is turned over.

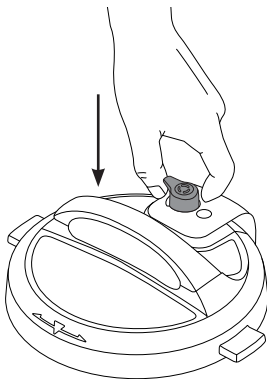

Anti-block shield

Remove the anti-block shield

Grip the lid like a steering wheel and use your thumbs to press firmly against the side of the anti-block shield (pressing towards the side of the lid and up) until it pops off the prongs underneath.

Install the anti-block shield

Place the anti-block shield over the prongs and press down until it snaps into position.

Do not attempt to operate the pressure cooker without the anti-block shield installed.

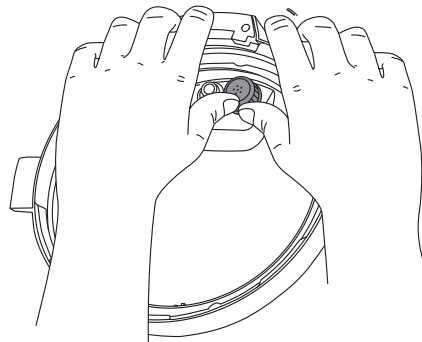

Remove

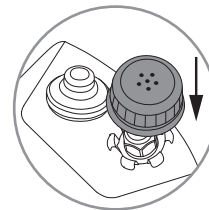

Install

Illustrations in this document are for reference only and may differ from the actual product. Always refer to the actual product.

Care, cleaning and storage

Float valve and silicone cap

Remove the float valve

Place one finger on the flat top of the float valve, then turn the lid over. Detach the silicone cap from the bottom side of the float valve. Remove the float valve from the top of the lid.

 Do not discard the float valve or silicone cap.

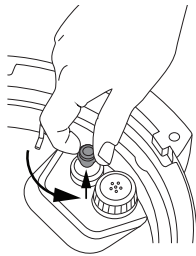

Top of lid

Install the float valve

Drop the narrow end of the float valve into the float valve hole on the top of the lid. Place one finger on the flat top of the float valve, then turn the lid over. Firmly attach the silicone cap to the bottom of the float valve.

Do not attempt to operate the pressure cooker without having the float valve and/or silicone cap properly installed in the pressure cooking lid.

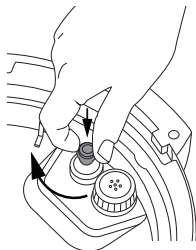

Bottom of lid

Condensation collector

The condensation collector sits at the back of the multicooker base and catches any overflow from the condensation rim.

It should be installed before cooking, then emptied and rinsed out after each use.

Remove the condensation collector

Pull the condensation collector away from the multicooker base; **do not pull down**. Note the tabs on the multicooker base and the grooves on the condensation collector.

Install the condensation collector

Align the grooves on the condensation collector over the tabs on the back of the multicooker base and slide the condensation collector into place.

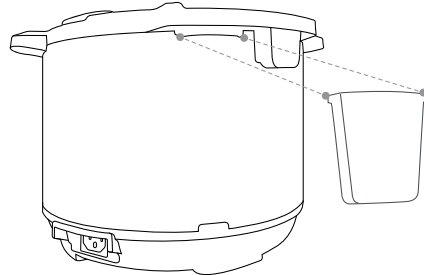

Illustrations in this document are for reference only and may differ from the actual product. Always refer to the actual product.

Troubleshooting

Register your Instant Pot today!

If your problem persists or if you have questions, get in touch with a Customer Care Advisor by email at support@instantpot.co.uk or by phone on **+44 (0) 3331 230051**.

Problem	Possible reason	Try this
Occasional clicking or light cracking sound.	The sound of power switching and the pressure board expanding when changing temperatures.	This is normal; no action needed.
	Bottom of the inner pot is wet.	Wipe exterior surfaces of the inner pot. Make sure the heating element is dry before inserting the inner pot back into the multicooker base.
Difficulty closing the lid.	Sealing ring is not properly installed.	Reposition the sealing ring. Make sure it is snug behind the sealing ring rack.
	Float valve is in the popped-up position.	Gently press the float valve downward with a long utensil.
	Contents in multicooker are still hot.	Turn the steam release handle to the Venting position, then lower the lid onto the multicooker base slowly, allowing heat to dissipate.
Difficulty opening the lid.	Pressure inside the multicooker.	Release pressure according to recipe. Only open the lid after the float valve has dropped down.
	Float valve stuck in the popped-up position due to food debris or residue.	Make sure steam is completely released by quick-releasing pressure, then press the float valve gently with a long utensil.
		Open the lid carefully, then thoroughly clean the float valve, surrounding area and lid before next use.
	⚠ DANGER Contents may be under pressure. To avoid scalding injury, DO NOT attempt to force the lid open.	
The inner pot is stuck to the lid when the multicooker is opened.	Cooling of the inner pot may create suction, causing the inner pot to adhere to the lid.	To release the vacuum, turn the steam release handle to the Venting position.
Steam gushes from the steam release handle when it is in the Sealing position.	Not enough liquid in the inner pot.	Add thin, water-based liquid to the inner pot according to its size. 3 L: 250 mL 5.7 L: 375 mL 8 L: 500 mL
	Pressure sensor control failure.	Contact Customer Care .
	Steam release handle is not seated properly.	Turn the steam release handle to the Sealing position.

Troubleshooting

Problem	Possible reason	Try this
Steam leaks from side of lid.	No sealing ring in the lid.	Fit a sealing ring.
	The sealing ring is damaged or not properly fitted.	Replace the sealing ring.
	Food debris attached to the sealing ring.	Remove the sealing ring and clean it thoroughly.
	The lid is not closed properly.	Open, then close the lid.
	The sealing ring rack is warped or off-centre.	Remove the sealing ring from the lid, then check the sealing ring rack for bends or warps. Contact Customer Care .
	The inner pot rim may be misshapen.	Check for deformation and contact Customer Care .
The float valve does not rise.	Food debris on the float valve or float valve silicone cap.	Remove the float valve from the lid and clean it thoroughly. Perform the Initial test run to check operation and record your findings. Contact Customer Care .
	Too little liquid in the inner pot.	Check for scorching on the bottom of the inner pot. Add thin, water-based liquid to the inner pot according to its size. 3 L: 250 mL 5.7 L: 375 mL 8 L: 500 mL
	Float valve silicone cap damaged or missing.	Fit or replace the float valve and/or silicone cap.
	Float valve obstructed by lid-locking mechanism.	Tap the float valve with a long utensil. If the float valve does not drop, turn the multicooker off. Contact Customer Care .
	No heat in the inner pot.	Perform the Initial test run to check operation and record your findings. Contact Customer Care .
Inner pot base may be damaged.	Perform the Initial test run to check operation and record your findings. Contact Customer Care .	
Small amount of steam leaking/hissing from the steam release handle during the cooking cycle.	Steam release handle is not in the Sealing position.	Turn the steam release handle to the Sealing position.
	Multicooker is regulating excess pressure.	This is normal; no action required.

Troubleshooting

Problem	Possible reason		Try this
The display remains blank after connecting the power lead.	Bad power connection or no power.		Inspect power lead for damage. If damage is noticed, contact Customer Care . Check socket to make sure it is powered.
	Cooker's electrical fuse has blown.		Contact Customer Care .
Error code appears on the display and the multicooker beeps continuously.	C1 C2 C6 C6H C6L	Faulty sensor.	Contact Customer Care .
	C5	Temperature is too high because the inner pot has not been placed in the multicooker base.	Press Cancel and wait for heating element to cool; make sure there are no foreign objects in multicooker base; insert or reposition inner pot in multicooker base and re-enter commands.
		Temperature is too high.	Check for scorching on bottom of inner pot. Add thin, water-based liquid to the inner pot according to its size. 3 L: 250 mL 5.7 L: 375 mL 8 L: 500 mL
	C7 or NoPr	Heat element has failed.	Contact Customer Care .
		Not enough liquid.	Add thin, water-based liquid to the inner pot according to its size. 3 L: 250 mL 5.7 L: 375 mL 8 L: 500 mL
		Steam release handle is in the Venting position.	Turn the steam release handle to the Sealing position.
	Lid	Lid is not in the correct position for the selected programme.	Open and close the lid.
Do not use a lid when using Sauté .			
Error code appears on the display and the multicooker beeps continuously.	Food burn	High temperature detected at bottom of inner pot; multicooker automatically reduces the temperature to avoid overheating.	Starch deposits at the bottom of the inner pot may have blocked heat dissipation. Turn the multicooker off, release pressure according to the recipe, and inspect the bottom of the inner pot.
	PrSE	Pressure has accumulated during a non-pressure cooking programme.	Turn the steam release handle to the Venting position.

Any other servicing must be performed by an authorised representative.

Warranty

Warranty Registration

Please visit <https://www.instantpot.co.uk/support/register-your-product/> to register your appliance. You will be asked to provide your name, your email address, the store name, date of purchase, model number and serial number (both of which are found on the appliance). This registration will enable us to keep you up-to-date with product developments and recipes, and contact you in the unlikely event of a product safety notification. By registering, you acknowledge that you have read and understood the instructions for use and warnings accompanying the appliance.

Warranty Service

- Your name, email address or phone number.
- A copy of the original purchase receipt with order number, model and serial number.
- A description of the product defect, including any photographs or video if possible.

Warranty Registration

Instant Pot / Earlyview Ltd
Unit 5 Hershaw Farm Business Park
Kitsmead Lane
Chertsey, Surrey KT16 0DN, UK

Email: support@InstantPot.co.uk

Telephone: 03331 230051

This warranty was last updated on 1 September 2019 for all products sold from [1 November 2019]. If your product comes with our older warranty version, your warranty will continue to be honoured.

Recycling

This appliance complies with the WEEE Directive 2012/19/EU on the disposal of electrical and electronic equipment (WEEE). This appliance complies with the European directive for electromagnetic compatibility (EMC) 2014/30/EU and its revisions, as well as Low Voltage Directive (LVD) 2014/35/EU and its revisions.

This marking indicates that this product should not be disposed of with other household waste throughout the EU. To prevent possible harm to the environment or human health from uncontrolled waste disposal, recycle it responsibly to promote the sustainable re-use of material sources. To return your used device, please use the return and collection systems or contact Customer Care for further recycling and WEEE information.



Warranty

Limited Warranty

Earlyview Ltd., an authorised distributor of Instant Brands, Inc., and Instant Brands Inc. (collectively the "Company") warrant this appliance to be free from defects in workmanship and material, under normal household use, for a period of one (1) year from the date of original purchase. This Limited Warranty extends only to the original purchaser and use of the appliance in the UK. This warranty does not cover appliance use outside of the UK.

Proof of original purchase date and, if requested, return of your appliance is required to obtain service under this Limited Warranty. Provided that this appliance is operated and maintained in accordance with the written instructions included with the appliance (which are also available at instantpot.co.uk), the Company will, at its sole discretion, either: (i) repair defects in materials and workmanship; or (ii) replace the appliance. In the event the appliance is replaced, the Limited Warranty on the replacement appliance will expire 12 months from the date of original consumer purchase.

The Company is not responsible for shipping costs for warranty service.

Limitation and Exclusions

Any modification or attempted modification to your appliance may interfere with the safe operation of the appliance and may result in serious injury and damage. Any modification or attempted modification to your appliance or any part thereof will void the warranty, unless such modification(s) or alteration(s) were expressly authorised by the Company.

This warranty does not cover (1) normal wear and tear; (2) damage resulting from negligent, unreasonable or misuse of the appliance, improper assembly or disassembly, use contrary to the operating instructions, failure to provide reasonable and necessary maintenance, Acts of God (such as fire, flood, hurricanes and tornadoes), or repair or alteration by anyone, unless expressly directed and authorised by the Company; and (3) repairs where your appliance is used for other than normal household use and in a manner contrary to published user or operator instructions.

To the extent permitted by applicable law, the liability of the Company, if any, for any allegedly defective appliance or part shall be limited to repair or replacement of the appliance or part thereof, and shall not exceed the purchase price of a comparable replacement appliance. Except as expressly provided herein and to the extent permitted by law, (1) the Company makes no warranties, conditions or representations, express or implied, usage, custom of trade or otherwise with respect to the appliance or parts covered by this warranty and (2) the Company shall not be responsible or liable for indirect, incidental or consequential damages arising out of or in connection with the use or performance of the appliance or damages with respect to any economic loss, loss of property, loss of revenues or profits, loss of enjoyment or use, costs of removal, installation or other consequential damages of any nature or kind.

You may have rights and remedies under applicable laws, which are in addition to any right or remedy which may be available under this limited warranty.

Instant Pot™

Instant Brands Inc.

11–300 Earl Grey Dr., Suite 383
Ottawa, Ontario K2T 1C1, Canada

Distributed by

Earlyview Ltd (Instant Brands Official Distributor)
Unit 5 Hershams Farm Business Park
Kitsmead Lane
Chertsey, Surrey KT16 0DN, UK

Register your product today

<https://www.instantpot.co.uk/support/register-your-product/>

Contact us

+44 (0) 3331 230051
support@instantpot.co.uk
instantpot.co.uk
instantpot.co.uk/instant-pot-shop

Join the Official Instant Pot Community

www.facebook.com/groups/InstantPotUKCommunity

Download Free App



 @instantpotUK

 @InstantPotUK

 @instantpotuk

Made in China

Copyright© 2021 Instant Brands™ Inc.
801-0104-91