



AQ-SFRO2

Under Sink Water Filter
SmartFlow[®]
Reverse Osmosis
Owner's Manual





Meet clean, healthy water. Your new SmartFlow® Reverse Osmosis uses both Claryum® and reverse osmosis filtration to reduce up to 99.99% of 90 contaminants*. The system's patented SmartFlow® technology is engineered to provide you with more pure water, less water waste, and longer filter life than the average RO system.

Enjoy the peace of mind that comes from knowing our award-winning filter technology is working for you.

AQ-SFRO2

Under Sink Water Filter SmartFlow® Reverse Osmosis

TABLE OF CONTENTS

Box Contents.....	1
Installation Steps.....	2-11
Care & Safeguards.....	12-14
Filter Replacements.....	15
Performance & Certifications.....	16
Troubleshooting Guide.....	17-19
Warranty.....	20
Water for Life®.....	21

**See Performance & Certifications (page 16) for specifics about contaminants reduced.*

Scan to view the
SmartFlow® Reverse
Osmosis installation video.



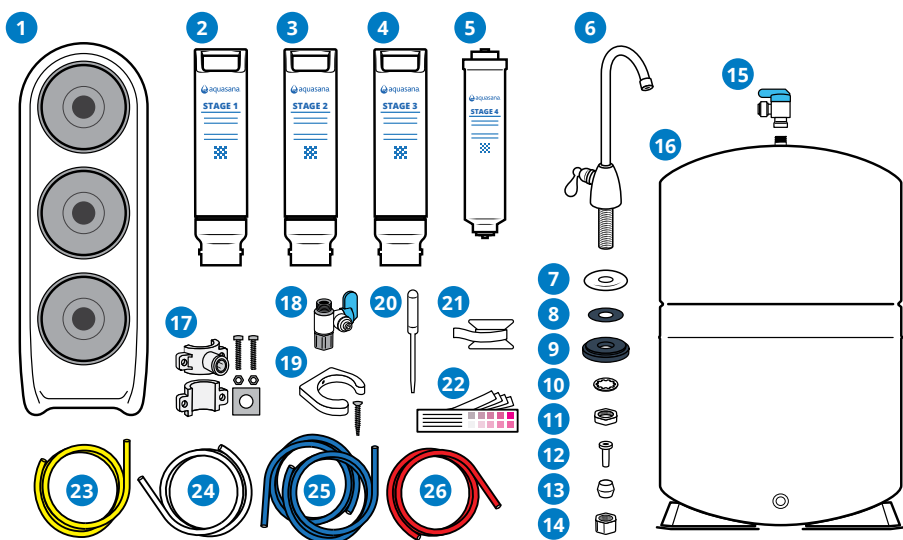

- | | |
|----------------------------------|--------------------------------|
| 1 System Manifold | 14 Chrome Nut |
| 2 Stage 1: Carbon Block | 15 Water Tank Valve |
| 3 Stage 2: SmartFlow® Membrane | 16 Water Tank and Stand |
| 4 Stage 3: Advanced Carbon Block | 17 Drain Saddle Kit |
| 5 Stage 4: Remineralizer | 18 Easy-Connect Shut-Off Valve |
| 6 Faucet | 19 Remineralizer Bracket |
| 7 Faucet Base | 20 Eye Dropper |
| 8 Rubber Washer | 21 Plumber's Tape |
| 9 Faucet Spacer | 22 Water Test Kit |
| 10 Lock Washer | 23 Yellow 1/4" Tubing |
| 11 Faucet Nut | 24 White 1/4" Tubing |
| 12 Plastic Tube Insert | 25 Blue 1/4" Tubing (2) |
| 13 Plastic Collar | 26 Red 1/4" Tubing |

NOTE: If you purchased a SmartFlow® Reverse Osmosis without a dedicated faucet, contents will not include 6 - 14.

If you received a dedicated faucet with the 1/4" blue tubing attached, parts 12 - 14 will not be included. This manual addresses this installation in step 2.

Box contents will be packaged in multiple boxes.

Before beginning installation, please ensure all parts listed are present. If any part is missing or damaged, do not attempt to install the system.

Please contact Customer Support for replacement parts at **866-662-6885**.

Tools recommended for installation

- Tape measure
- Adjustable wrench
- Pan or bucket
- Phillips head screwdriver
- Bleach
- Utility knife
- Drill with 1/4" bit
- Pencil
- Safety glasses

NOTE: We recommend using a professional if pipe cutting or drilling is required. Basic plumbing knowledge is recommended prior to installing this unit.

1 Setup

For models that include a dedicated faucet:

NOTE: This system requires an existing faucet hole at least 1/2" in diameter in the sink or countertop to install the supplied dedicated faucet. You may also replace an existing kitchen sink sprayer, soap dispenser, or use pre-existing hole on the sink or countertop.

If using a hole from a current dedicated faucet, ensure the hole is at least 1/2" in diameter.

If drilling a new hole, ensure faucet body will mount flat against surface and there is sufficient tubing between faucet body and system manifold. If drilling, we strongly recommend using a professional. Please wear safety glasses when drilling.

For model without a dedicated faucet:

NOTE: This system requires an existing faucet hole, please refer to the installation guide of the faucet purchased to determine hole size needed to drill.

This system requires tubing to be 1/4" outside diameter. If you have 3/8" outer diameter tubing, you will need to purchase quick connect adapters.

NOTE: Certain plumbing codes mandate the installation of either an air gap faucet or a backflow preventer on the drain connection when installing reverse osmosis (RO) water filtration systems. This requirement is designed to prevent cross-contamination of drain water with the drinking water supply, ensuring the system complies with health and safety standards.

Before installation, consult your local plumbing codes or a licensed plumber to determine the specific requirements in your area. Failure to comply with local codes may result in improper operation or contamination of the water supply.

- A. Unpack and unwrap box contents.
- B. Turn off COLD water supply. Turn on the cold water at the kitchen faucet to release pressure and allow water to drain from the line.
- C. Temporarily place system manifold and water tank into the under sink cabinet or desired location to ensure adequate space and proper positioning.
- D. Ensure all tubing lengths are sufficient for making connections. Do not cut tubing before following step 2.
- E. Remove system manifold and water tank from under your sink to begin installation.

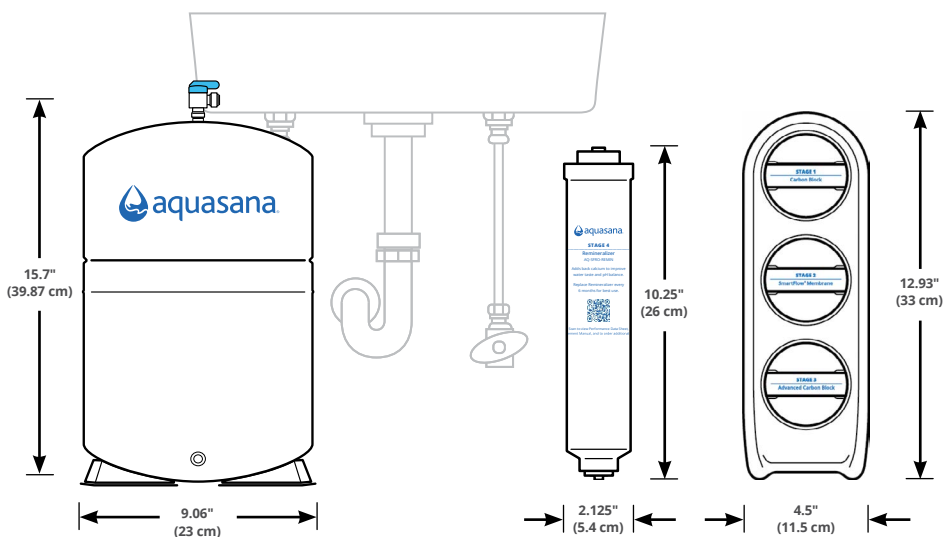

DRAWING NOT TO SCALE, SYSTEM AND TANK ENLARGED.

2 Install Dedicated Faucet

For Separate Faucet

If you purchased a separate faucet, skip step 2 (Install Dedicated Faucet) and follow the faucet manufacturer's installation manual. Once the faucet is installed, proceed to step 3 on page 4.

For Pre-Attached Tubing to Dedicated Faucet

Follow steps 2 A-E by assembling parts over tubing. Once complete, proceed to step 3.

For Non-Pre-Attached Tubing

- Unscrew the nut from the threaded faucet base. Slide the metal faucet base onto dedicated faucet, followed by the rubber washer. Insert faucet into drilled hole.
- From underneath the sink, slide faucet spacer onto dedicated faucet.
- Slide lock washer onto dedicated faucet.
- Screw the faucet nut back on to secure faucet and parts to countertop. Tighten with a wrench.

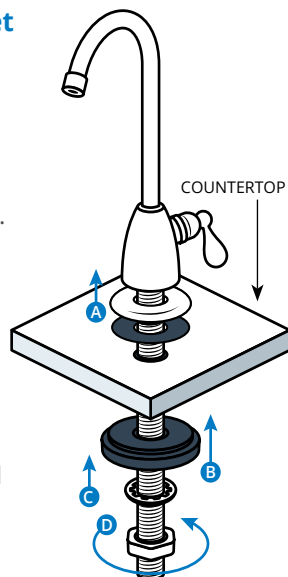

NOTE: Do not over tighten.

4 INSTALLATION STEPS

- E. Slide the chrome nut onto the 1/4" blue tubing, followed by the white plastic collar.

NOTE: If your faucet includes pre-attached tubing, use wrench to tighten the chrome nut and proceed to step 3.

- F. Press the plastic tube insert into the end of the tubing.
G. Press the tubing against the faucet base, and slide the chrome nut and plastic collar up to the threads of the faucet. Use wrench to tighten the chrome nut.

NOTE: Do not over tighten.

WARNING: Ensure all electrical appliances and outlets are turned off at circuit breaker before continuing. Please wear safety glasses when drilling.

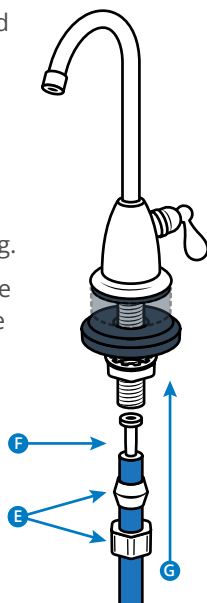

3 Install Drain Saddle

- A. Identify drain outlet location on drainpipe to install drain clamp. Do not install drain clamp on the same drainpipe as garbage disposal. Mount drain clamp on a section of vertical or horizontal drainpipe that is above the drain trap and unobstructed for drilling.
B. Using the drain connector hole as a template, drill a 1/4" hole into the drainpipe. Only drill through one side of the drainpipe.

NOTE: If the foam gasket is attached to the drain saddle, proceed to step D. If it is not attached, continue with step C.

- C. Take the connection half of the drain clamp and attach the foam gasket. Do so by removing the center hole and protective cover from the back of the foam gasket. Align the foam gasket hole with the hole on the inside of the drain clamp. The adhesive side of the foam gasket should be facing the inside of the drain clamp. Press firmly to attach.

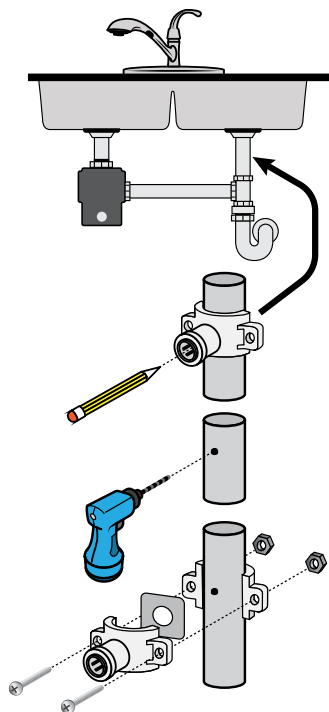

- D. Insert nuts into the other half of the drain clamp. Place both halves together around the drainpipe, aligning with the hole you drilled. Use drill bit to help align.
- E. Tighten nuts and screws to secure the drain clamp halves around the drainpipe. Tighten with screwdriver. Do not over tighten.

4 Prepare All Tubing Ends

- A. If tubing needs to be cut to length, make sure to use a sharp cutting device to achieve a square cut.
- B. Mark a line 0.625" from the end of each tube.

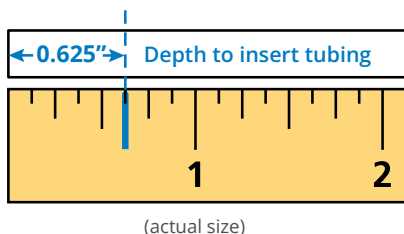

5 Install Easy-Connect Shut-Off Valve and Tubing

NOTE: Ensure cold water valve is turned off before continuing.

- A. Place a pan or bucket under cold water line to catch any excess water. With an adjustable wrench, disconnect COLD water line from the supply line at shut-off valve.

- B. Attach threaded ends of easy-connect shut-off valve to the cold water line connection on the shut-off valve. Tighten with wrench. Do not over tighten.

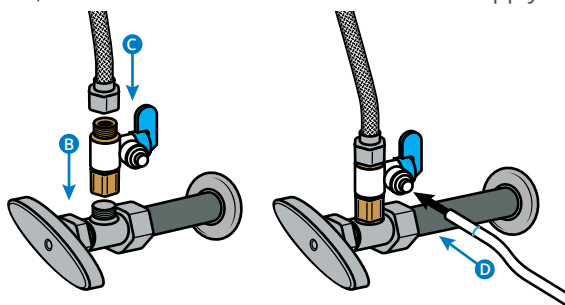

- C. Reattach the cold water line to the open easy-connect shut-off valve.

ENSURE TUBING IS INSERTED 0.625"

- D. Push white tubing into the open quick connect valve until the mark on the tubing is at or inside the opening. Ensure easy-connect shut-off valve is in the open position.

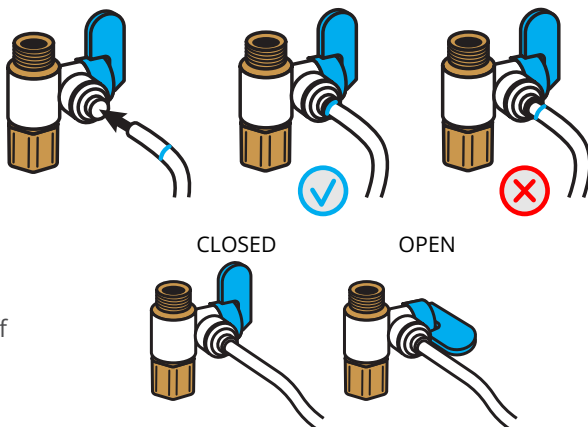

6 Install System Manifold, Water Tank Stand, and Remineralizer Bracket

- Place system manifold under the sink in a place that will be easy to access for scheduled filter changes. Do not install filter cartridges at this time.
- Using your screw driver and included screw, install the remineralizer bracket on your cabinet wall near the system manifold. Insert remineralizer cartridge with sticker text upward.
- Finally, place water tank stand near the system manifold.

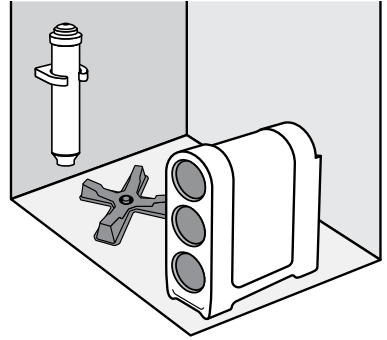

NOTE: Placement of bracket must be close to system manifold to ensure tube length needed for connection is sufficient.

7 Sanitize and Install Water Tank

- From the accessories box, find the plumber's tape roll and water tank valve.
- Wrap the plumber's tape around the threaded stainless steel connector located on top of the water tank 4-5 times.
- Screw the water tank valve onto the plumber's tape wrapped stainless steel connector.
- Hand tighten water tank valve until secure (be sure not to cross-thread or over-tighten). After you have secured with hand tightening, tighten with wrench a quarter turn to ensure secure fit. Ensure water tank valve is open, valve should be pointing towards the valve port.

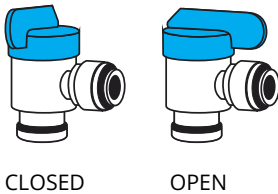

TURN TO THE RIGHT

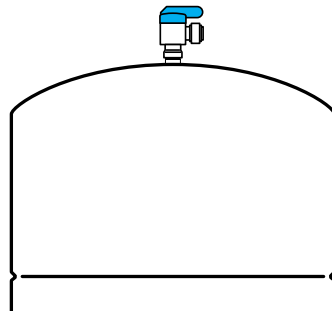

- E. Insert one end of the yellow tubing into the water tank valve. Using the included eye dropper, add 3mL bleach into the open end of the attached yellow tubing.

NOTE: Sanitation step will be completed during the pressure test and flush step of the installation.

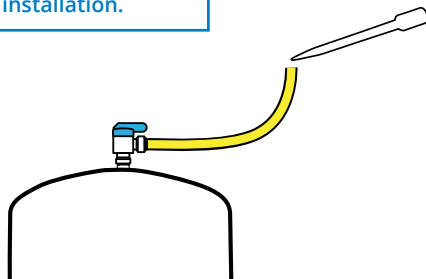

NOTE: Keep yellow tubing upright so that bleach does not spill or leak.

8 Connect Water Tank to Manifold

- A. While keeping the yellow tubing upright, place water tank on the tank stand.
- B. Connect water tank to the system manifold. Do so by connecting the other end of the yellow tubing to the yellow inlet port on the backside of the system manifold, labeled, 'TANK'.

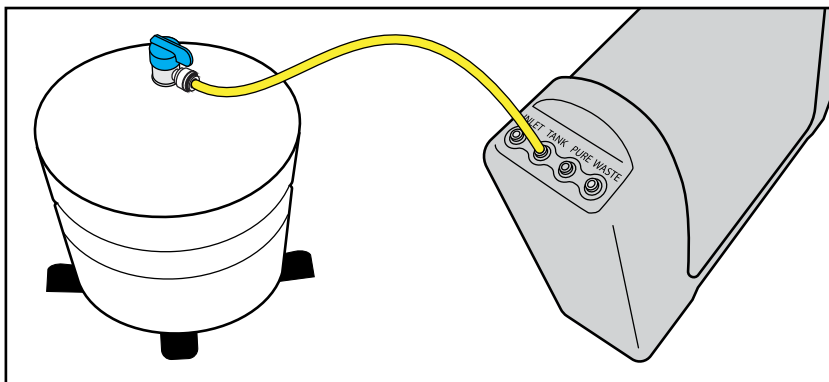

9 Connect Tubing

NOTES: Insert tubing completely until the mark on tubing is at or inside the opening. A fully connected tube can be inserted up to 0.625".

Wet end of tubing for easier insertion.

Connect tubing to system in a way that does not bend, crimp, or kink tubing as this will affect system performance. If tubing is too long, measure and cut to necessary length. If cutting the tubing due to excess length, cut the tubing straight across, not at an angle.

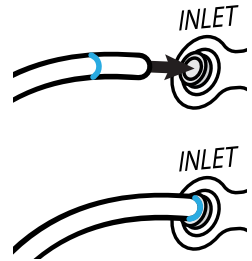

Drain, Faucet, and Remineralizer Connect

- A. Push one end of 1/4" red tubing into the drain saddle valve fitting. Push the other end into the red inlet port on the back of the system manifold, labeled 'WASTE'.

NOTE: If you are installing an air gap adapter, do so at this time. Please consult the manufacturer's Owner's Manual for installation steps.

- B. Push 1/4" blue tubing coming from faucet into the bottom end of the remineralizer port.
- C. Locate the blue tubing piece included in the installation kit and connect to the top port of the remineralizer. Connect open end of blue tubing coming from the remineralizer into the blue inlet port on the back of the system manifold labeled, 'PURE'.

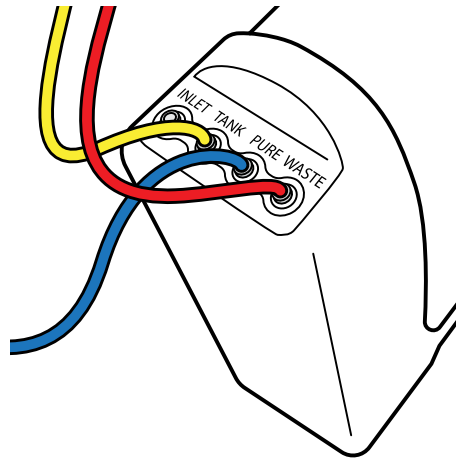

Easy-Connect Shut-Off Valve Connect

- A. Locate the white tubing, connect to the easy-connect shut-off valve, and push into the white inlet port on the back of the system manifold, labeled, 'INLET.'

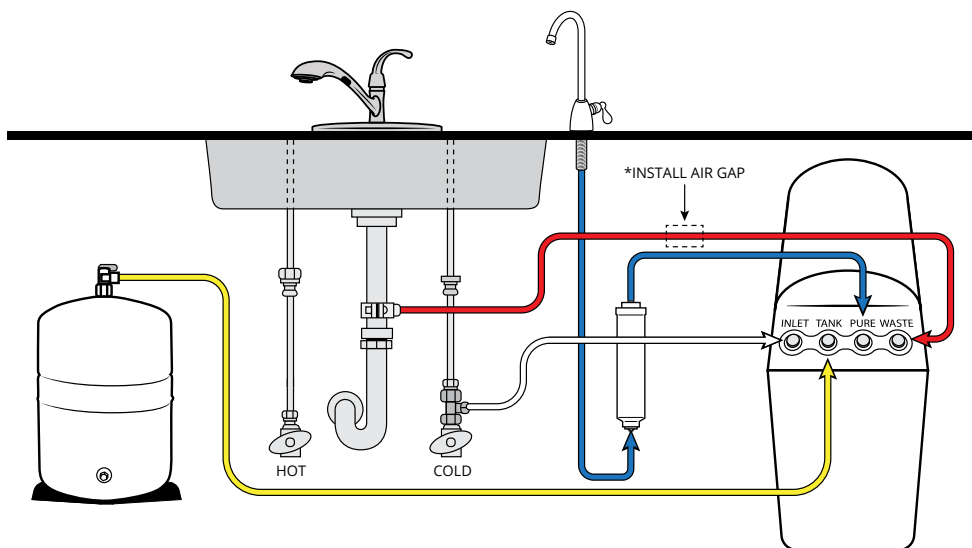

*Properly install air gap to comply with local codes. Air gap must be two pipe diameters or 1 inch (25mm), whichever is larger.

10 Insert Filter Cartridges

- A. Insert each filter cartridge into its designated location in the system manifold by turning to the right. Ensure filter cartridge handle is vertical to the system manifold before inserting. The guides on each filter will ensure proper alignment within the system manifold.

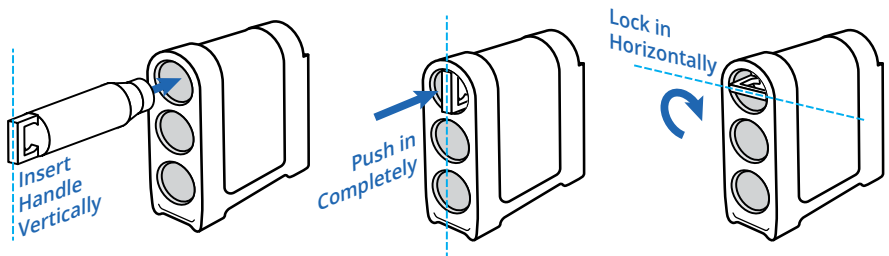

- B. Once the filter is engaged, push the filter fully in while rotating 90 degrees to the right. Continue this step for each filter.

- Top filter: Carbon Block
- Middle filter: SmartFlow® Membrane
- Bottom filter: Advanced Carbon Block

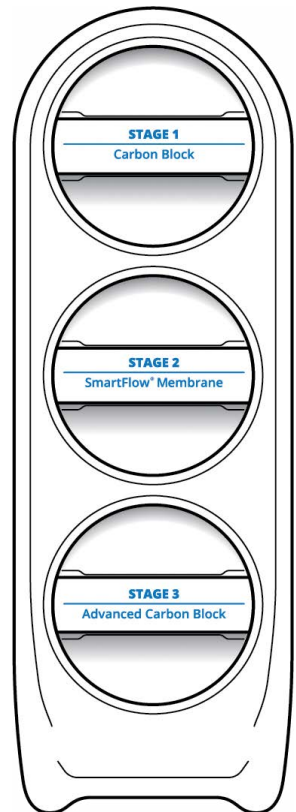

11 Pressure Test, Check for Leaks, and Flush

- A. Turn off dedicated faucet.
- B. Turn on COLD water supply valve.
- C. Turn on kitchen faucet to release air from pipes. Once water is flowing normally, turn off kitchen faucet.
- D. Within approximately two hours, the water tank will fill. Carefully inspect all connections and fittings for leaks.
- E. After ensuring all connections and fittings are secured, turn on the dedicated faucet and let water flush until the tank empties and the flow from the faucet slows to almost nothing. Close the faucet, wait two more hours for the tank to fill again, and empty the tank. Repeat this step two more times.

NOTE: Water flow rate will be slow during initial flush. A bubbling noise can be expected. Do not drink the flushed water.

- F. Once you have emptied three tanks of water, close all faucets and refill for regular use.

NOTE: After initial system flush, it will take 1-3 hours for the water tank to fill.

Care

To clean the system manifold and tank, wipe exterior with a damp cloth. Do not use any strong or abrasive cleaning agent or solvent cleaner.

NOTICE

Safeguards

- If you experience a tubing connection leak, shut off cold water, disconnect and re-set the tube.
- Do not install this system where the line pressure may exceed 80 psi. The operating pressure range for this system is between 40-80 psi.
- Install on COLD water lines only (40°F-100°F).
- It is recommended that your system be installed inside and out of direct sunlight. The system must be protected from both direct sunlight and freezing temperatures.
- System and installation shall comply with applicable state and local laws.
- Do not operate without the filters installed.
- Do not use with water that is microbiologically unsafe or of unknown water quality without adequate disinfection before or after the system.
- Systems certified for cyst reduction may be used on disinfected waters that may contain filterable cysts.
- This reverse osmosis system contains a replaceable treatment component that is critical for the effective reduction of total dissolved solids. It is recommended to periodically test this reverse osmosis system to verify it is performing properly.
- This reverse osmosis system contains a replaceable component critical to the efficiency of the system. Replacement of the reverse osmosis component should be with one of identical specifications, as defined by the manufacturer, to ensure the same efficiency and contaminant reduction performance.
- This system has been tested and certified for Nitrate/Nitrite reduction according to NSF/ANSI Standard 58. Proper maintenance is required to keep the system functioning according to specifications. It is recommended you check your water every 3-4 months. Nitrate/Nitrite test included, see test kit for sampling instructions.

AQ-SFRO2**Replacement cartridges AQ-SFRO-S1S3, AQ-SFRO-S2, and AQ-SFRO-REMIN**

Membrane TDS reduction: 89.6% minimum

Membrane TDS reduction: 96.4%+ average

Max TDS: 1000 ppm

Max water hardness @ 6.9 pH: 10 gpg (2.64 g/L)

Max chlorine in water: 3 ppm

Supply water pH limits: 4-10

Storage tank capacity: 2.5 gallons (9.46 liters)

Supply water pressure limits: 40-80 psi
(275-551 kPa)Supply water temperature limit: 40-100°F
(4-38°C)

Do not use the system on microbiologically unsafe water, or water of unknown quality without adequate disinfection before or after the system. This system is certified for cyst reduction and may be used on disinfected water that may contain filterable cysts.

Installations in The Commonwealth of Massachusetts: The Commonwealth of Massachusetts requires installation be performed by a licensed plumber and does not permit the use of saddle valves. Plumbing code 248—CMR of the Commonwealth of Massachusetts must be followed in these cases.

Specifications

Efficiency rating is the percentage of the influent water to the system that is available to the user as reverse osmosis treated water. This measurement is taken under operation conditions that approximate typical daily usage. The system's efficiency rating was verified by testing in accordance with Section 6.8 found in NSF/ANSI 58.

Recovery rating is the percentage of the influent water to the membrane portion of the system that is available to the user as reverse osmosis treated water when the system is operated without a water tank or when the water tank is bypassed. The system's recovery rating was verified by testing in accordance with Section 6.8 found in NSF/ANSI 58.

Because the performance of a reverse osmosis membrane is highly dependent upon pressure, temperature, and Total Dissolved Solids (TDS), the following should be used for comparison only.

Lower temperatures are directly proportional to slower flow rate. The reverse osmosis system should not be installed in a location susceptible to freezing. Incoming water temperature should not exceed 100°F (38°C). The more TDS in the supply water, the more filter time required. Incoming TDS should not exceed 1000 ppm. Higher water pressure enables a higher flow rate. Pressure must be at or above 40 psi for proper system operation. You may consider installing a booster pump if your pressure is below 40 psi.

Flow rate and output are determined by the following factors:

1. Incoming water temperature
2. Total dissolved solids (TDS) present in supply water
3. Incoming water pressure
4. Tank size and amount of water in the tank

This system has been tested for the treatment of water containing pentavalent arsenic (also known as As(V), As(+5), or arsenate) at concentrations of 0.05 mg/L or less. This system reduces pentavalent arsenic, but may not remove other forms of arsenic. This system is to be used on water supplies containing a detectable free chlorine residual at the system inlet or on water supplies that have been demonstrated to contain only 50 ppb (0.050 mg/L) pentavalent arsenic. Treatment with chloramine (combined chlorine) is not sufficient to ensure complete conversion of trivalent arsenic to pentavalent arsenic. Please see the Arsenic Facts section below for further information.

Arsenic Facts

Arsenic (As) is a naturally occurring contaminant found in many ground waters. Arsenic in water has no color, taste or odor. It is measured by a laboratory test. Public water utilities must have their water tested for arsenic. You can get the results from your water utility. If you have your own well, you can have the water tested. The local health department or the state environmental health agency can provide a list of certified labs. Information about arsenic in water can be found on the internet at the U.S. Environmental Protection Agency website:

epa.gov/safewater/arsenic

There are two forms of arsenic: pentavalent arsenic (As(V), As(+5), and arsenate) and trivalent arsenic (also called As(III), As(+3), and arsenite). Although both forms of arsenic are potentially harmful to human health, trivalent arsenic is considered more harmful than pentavalent arsenic. In water, arsenic may be pentavalent, trivalent, or a combination of both. Special sampling procedures are needed for a lab to determine what type and how much of each type of arsenic is in the water. Check with the

labs in your area to see if they can provide this type of service.

If you get your water from a public water utility, contact the utility to find out if free chlorine or combined chlorine is used in the water system. **The AQ-SFRO2 system is designed to reduce pentavalent arsenic only. It will not convert trivalent arsenic to pentavalent arsenic.** This System was tested in a lab. Under testing conditions, the system reduced [0.050 mg/L (ppm)] pentavalent arsenic to 0.010 mg/L (ppm) (the USEPA standard for drinking water) or less. The removal performance of pentavalent arsenic of the system may be limited due to water quality conditions (i.e. iron-containing water or other water quality conditions). Have your treated water tested for arsenic to check whether the system is working properly.

The SmartFlow® Membrane of the AQ-SFRO2 system must be replaced every 12 months to ensure the system will continue to remove pentavalent arsenic. Information regarding component identification and places to purchase replacement are listed in the manual.

Carbon Block and Advanced Carbon Block

*Replace every 6 months**

The Carbon and Advanced Carbon Blocks are replaceable activated carbon cartridges located in Stages 1 and 3. It is recommended to replace these cartridges at least every 6 months. You may need to replace more often with high water usage or high sediment levels. Timely replacement of these cartridges will protect the RO Membrane from high levels of chlorine and/or sediment. As these filters build up with sediment, you may notice slower water output.



Scan here to view the Carbon Block and Advanced Carbon Block replacement manual.

SmartFlow® Membrane

*Replace every 12 months**

The SmartFlow® Membrane is located in Stage 2. This membrane reduces the dissolved solids and organic matter. Most municipally treated water has a 7.0-7.5 pH. In this case you would need to replace your SmartFlow® Membrane every 12 months. Membrane life depends on pH and supply water hardness. Higher pH shortens membrane life by causing pin-hole leaks. When output, water quality, and production rate decrease, it is time to replace the filter.

*Filter life depends on water usage and water supply quality.



Scan here to view the SmartFlow® Membrane replacement manual.

Remineralizer

*Replace every 6 months**

The Remineralizer is located outside of the manifold. It is recommended to replace this cartridge every 6 months.



Scan here to view the Remineralizer replacement manual.

Model	Replacements	Recovery Rating
AQ-SFRO2	AQ-SFRO-S1S3 AQ-SFRO-S2 AQ-SFRO-REMIN	42.8%
Operating Temp. Range	Efficiency Rating	Daily Production
40-100° F 4-38° C	27.4%	25.7 gpd
Manufactured by: Aquasana, Inc. 4343 Hamilton Road · Groveport, OH 43125 866-662-6885		



System tested and certified by WQA to NSF/ANSI Standards 42, 53, 58, 401, and CSA B483.1 for the reduction of the claims specified on the Performance Data Sheet and at www.WQA.org. This system conforms to NSF/ANSI 53 for VOC reduction. See Performance Data Sheet for individual contaminants and reduction performance. All claims are verified and substantiated by test data.

In order to maintain the NSF/ANSI 58 certification of this product, the drain line installation must comply with the standard requirements of a vertical air gap of two pipe diameters or 25 mm (1 in), whichever is larger, or an air gap faucet that is tested and certified against NSF/ANSI 58 must be included.



For the full list of contaminants filtered, scan to view the AQ-SFRO2 Performance Data Sheet on Aquasana.com.



Issue

Resolution

Water Leak/ Drip From Tubing or Dedicated Faucet

Step 1: Turn off the cold water valve underneath the sink and depressurize the system by opening the faucet and releasing all the water.

Step 2: Ensure color-coded tubing is installed into the correct placement on the system.

Step 3: If cutting the tubing due to excess length, cut the tubing straight across, not at an angle.



Step 4: Check and make sure the tubing is fully inserted into the system manifold until tubing can no longer be pushed. A loose connection can cause a leak at the inlet/outlet.

Step 5: Once all tubing is installed and the system is re-connected, turn the water valve back on and check for leaks.

Step 6: Make sure that the cartridges are in the locked position. They should be rotated fully clockwise until the handles are horizontal (see illustration on page 18).

NOTE: If the unit is still leaking after checking the cartridges and tube connections, shut off the cold water valve to the RO unit and contact Customer Support at 866-662-6885.

If you are experiencing a leak or drip from the manifold, do not attempt to disassemble. Turn cold water valve off and contact Customer Support at 866-662-6885.

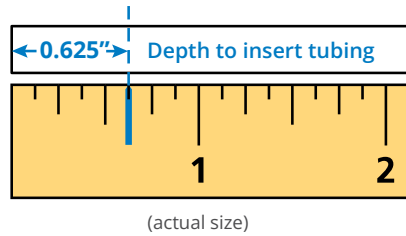

(actual size)

Water Leak/ Drip From Water Tank Valve

Step 1: Check to make sure the tubing is fully inserted into the port.

Step 2: Using a wrench, tighten the valve located on the top of the water tank.

Slow Flow

Step 1: Ensure water is flowing from the faucet. If water is flowing, close faucet and come back in 1-2 hours to re-check pressure. This will allow enough time for the tank to be filled.

Step 2: Check the feed temperature, pressure, and TDS to ensure inlet water conditions for proper operation are met.

Step 3: If it has been over six months since changing the Carbon Block and/or Advanced Carbon Block, we recommend changing these filters. We advise replacing the Carbon Block first, then the Advanced Carbon Block if the issue is not resolved.

NOTE: The best flow rate will be 0.8 GPM when the tank is completely full. The flow rate may slow as the water is depleted from the tank.

Issue

Resolution

Common Questions

How do I know I connected the tubing all the way?

The tubing must be inserted 0.625". We recommend making a mark at 0.625" from the end of the tube and then inserting the tube all the way up to that point. Since leaks may not appear immediately after installing, we recommend re-checking for leaks an hour after the tank has filled and continuing to check for leaks periodically.

Can I install the cartridges in the wrong stage?

No, the guides to help with insertion can only fit in their correct cartridge slot.

How do I know I connected the filter correctly?

The cartridge handle should be horizontal and handle labeling should be right side up.

INSERT
VERTICALLY

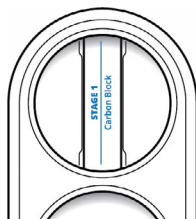

LOCK IN
HORIZONTALLY

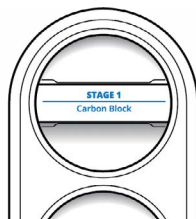
**How do I know the system is filtering my drinking water?**

The best way to know if you're drinking filtered water is to purchase a water quality test kit and a contaminant reduction test. Or, have a licensed professional test your drinking water.

Why is my water grey or black?

Carbon "fines" can be present in your water when new filters are first installed and will go away after the flushing cycle. Ensure you flushed your system for the adequate time on page 11.

Issue	Resolution
Common Questions	<p data-bbox="288 180 549 204">Why is my flow rate slow?</p> <p data-bbox="288 220 961 306">The inlet water pressure will affect your flow rate. While this system has a 0.8 gpm flow rate, if your flow rate is less than that, you can consider purchasing a booster pump.</p> <p data-bbox="288 347 942 371">Do I need to depressurize my system before replacing the filters?</p> <p data-bbox="288 380 921 591">Yes, you must depressurize the system before replacing any of the filters. Failure to release pressure can result in permanent system damage. Do so by closing the inlet tee valve and closing the water tank valve. Release the pressure by turning on the dedicated faucet until water stops flowing. Once water has stopped flowing from the dedicated faucet, turn the faucet off and proceed with filter replacement.</p> <p data-bbox="288 634 884 688">I have an existing dedicated faucet. Can I use that with this system?</p> <p data-bbox="288 704 828 729">Yes, as long as the faucet is compatible with a 1/4" tubing.</p> <p data-bbox="288 777 958 831">I have an existing air gap dedicated faucet. Can I use that with this system?</p> <p data-bbox="288 847 940 901">Yes, as long as the faucet is compatible with a 1/4" tubing. There is no need for a separate air gap adapter installed on the drain line.</p> <p data-bbox="288 951 694 976">How do I dispose of the filter cartridges?</p> <p data-bbox="288 992 916 1078">You can take the entire filter cartridge and put it in the trash. While it can't be recycled, it is designed with minimal components to help reduce waste.</p> <p data-bbox="288 1127 916 1180">When handling the filter cartridges, is it suppose to sound like something is moving around inside of the cartridge?</p> <p data-bbox="288 1196 924 1282">Yes, you may hear a noise inside of the filter cartridges, which is the carbon block media. Once the filter cartridges are installed in the manifold, you will not hear this noise.</p>



SmartFlow® Reverse Osmosis 2-Year Limited Warranty

WHO IS COVERED

AQUASANA AND ITS SUPPLIERS, (herein collectively referred to as "Manufacturer") warrants to the original owner who purchased and installed the system (hereinafter "Owner"). Registration of the product is not required to receive warranty coverage as specified in this document. If you purchased from an Aquasana-authorized reseller or dealer, proof of purchase is required.

WHAT IS COVERED

This Warranty covers defects in materials or workmanship during the limited Warranty period of your of your Aquasana Water Filtration System including sub-components purchased with original system (may or may not include faucet and fittings), except as provided below. The water filter is warranted only when it is installed, operated and maintained in accordance with the instructions accompanying the water filter found on Aquasana.com. A water filter should be installed in such a manner that, if the system or any connection thereto should leak, the resulting flow of water will not cause damage to the area in which it is installed. For detailed instructions read the manual accompanying the water filter and review drawings in the manual.

FOR HOW LONG

This Warranty runs for 12 months (365 days) from the date of purchase by a consumer (hereinafter "Warranty Period"). No Warranty coverage will be provided if the claimant is unable to provide proof of purchase from an authorized Aquasana reseller. Estimated lifespan of products is for information only and is based on usage approximations. Water conditions and use rates may limit the functional lifespan of your filter. This Limited Warranty does not extend to the full estimated life span of the system.

WHAT AQUASANA WILL DO

1. If necessary, the Manufacturer will provide a replacement that fulfills the remaining estimated lifespan/capacity of your original purchase and send it to you with installation instructions. If industry standards, product improvements or product obsolescence prohibit Manufacturer from furnishing an identical model replacement water filter under this Warranty, the Owner will be furnished with a new water filter of comparable remaining capacity and functionality; however, the Owner will be charged for the additional value of the item(s) which Manufacturer has incorporated in the replacement water filter. The Warranty period for any replacement will run for the balance of the original 365 days.
2. Component Part – If any component part proves to Manufacturer's satisfaction to be defective in material or workmanship within the Warranty period listed on the data plate label, the Manufacturer will furnish the Owner with a replacement for the defective part(s).
3. Return of Defective Water Filter and Component Parts – Manufacturer reserves the right to examine the alleged defect in the water filter or component part(s), and it will be the Owner's obligation to return the water filter and/or component part(s) to the Manufacturer at the Manufacturer's request.
 - a. When returning a water filter, it must include all component parts.
 - b. When returning component part(s), they must be individually tagged and identified with the water filter's model number, date of purchase, and date of installation.

WHAT IS NOT COVERED

1. This Warranty does not cover systems or components that were not installed in compliance with the instructions or that have been abused or operated incorrectly.
2. This Warranty does not provide routine replacement filter cartridges which must be purchased separately and replaced as indicated; replacement filter cartridges are available only when the original cartridge supplied with the system is damaged or defective when purchased. This Warranty applies only to products purchased from Aquasana or an Aquasana-authorized reseller or dealer.
3. Except when specifically prohibited by the applicable state law, the Limited Warranty stated herein is in lieu of any and all warranties, express or implied (whether written or oral), including, but not limited to, the implied warranties of merchantability and fitness for a particular purpose.
4. Except when specifically prohibited by the applicable state law, the Manufacturer shall not be liable for any incidental, consequential, special, or contingent damages or expenses,

arising, directly or indirectly, from any defect in the water filter of the use of the water filter.

5. Manufacturer shall not be liable for any incidental, consequential, special, punitive, or contingent damages or expenses, arising, directly or indirectly, from any defect in the water filter or the use of the water filter, including but not limited to water damage.
6. Manufacturer shall not be liable for any water damage arising, directly or indirectly, from any defect in the water filter or component part(s) or from its use.
7. Manufacturer shall not be liable for any damage or product failures caused by any of the following:
 - The water filter or any of its component parts have been subject to misuse, alteration, neglect or accident.
 - The water filter has not been installed in accordance with the applicable local plumbing and/or building code(s) and/or regulations or in their absence.
 - The water filter is not installed, operated and maintained in accordance with the printed Manufacturer's instructions, including if the water filter has any additional aftermarket equipment introduced into the sealed system not approved by the manufacturer.
 - The water filter is exposed to highly corrosive conditions.
 - The water filter is not continuously supplied with potable water.
 - The water filter is not operated within the factory calibrated temperature limits.
 - The water filter is installed in direct sunlight or exposed to freezing temperatures.
 - The water filter or any of its component parts fail due to sediment build-up.
 - Clogging due to purchaser's failure to replace the filter cartridges.
 - Damage caused by fire, flood or acts of God.
 - Damage caused by over-pressurization in the water line.
8. Manufacturer shall not be liable for any claims related to excessive noise, smell, or taste of water.
9. This Warranty does not cover damage caused by the use of parts that are not genuine Aquasana parts. This includes, but is not limited to replacement filters, faucets, and/or diverter valves.
10. Except when specifically prohibited by the applicable state law, the Owner, and not the Manufacturer, shall be liable for and shall pay for all charges for labor or other expenses incurred in the removal, repair or replacement of the water filter or any component part(s) claimed to be defective or any expense incurred to remedy any defect in the product. Such charges may include, but are not necessarily limited to:
 - a. All freight, shipping, handling and delivery costs of forwarding a new water filter or replacement part(s) to the owner.
 - b. All costs necessary or incidental in removing the defective water filter or component part(s) and installing a new water filter or component part(s).
 - c. Any material required to complete, and/or permits required for, installation of a new water filter or replacement part(s), and
 - d. All costs necessary or incidental in returning the defective water filter or component part(s) to a location designated by the Manufacturer.
11. This warranty provides specific legal rights and limitations, but you may have other rights under applicable state law.

HOW TO GET SERVICE

To receive service under this Warranty, you must contact Aquasana (A. O. Smith Water Treatment (North America), Inc.) at 1-866-662-6885 or support@aquasana.com within the Warranty Period to describe the problem to a customer service representative who will verify that the product is under Warranty and determine whether a part or the system will be replaced and whether you must send back the unit. You will be required to provide both proof of purchase and proper installation.

HOW STATE LAW APPLIES

This Warranty gives you specific rights and you may have other rights which vary from state to state. Some states do not allow the exclusion or limitation of incidental or consequential damages, so the above limitation or exclusion may not apply to you.



water for life®

Protect your investment and save money with Water for Life®.

Our Water for Life® program helps you protect the investment you've made in your family's health with an extended limited warranty on your new filtration system, a 15% discount on replacement filters, and free shipping.



Extended Limited Warranty

Our performance promise to you – free replacement parts when needed.*



Discounted Replacements

The only way to lock in a 15% discount on replacement filters.



Free Shipping

Replacements shipped to you right when you need them – at no extra cost.



No Contract

Free to join and cancel anytime – no long-term commitment required.

CONTACT US TO LEARN MORE



866-275-2319



waterforlife@aquasana.com

*Exclusions apply. Limited Warranty details are available at aquasana.com. Benefits are for the term of Water for Life membership.



LOVE IT?

Please let us know with a review on Aquasana or your retailer's site.



NEED HELP?

Give us a call at **866-662-6885** and tell us what's going on.