

WIDEX MOMENT™

USER INSTRUCTIONS

WIDEX mRIC CHARGE n CLEAN

WPC101 model



GB
ES
FR
IT
JP
SC
US





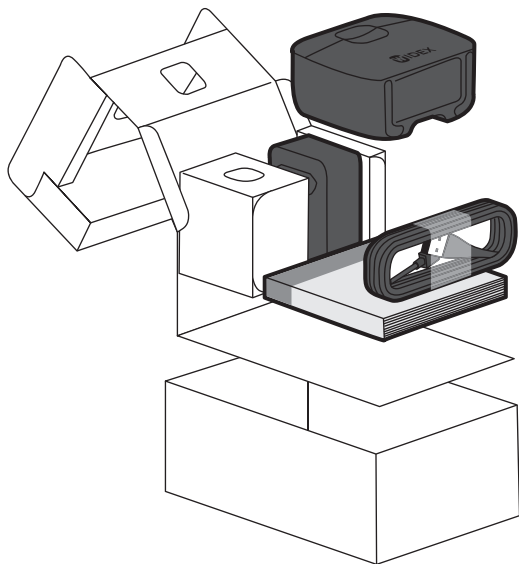



WIDEX®
HIGH DEFINITION HEARING

GB	USER INSTRUCTIONS	3
ES	INSTRUCCIONES DE USO	25
FR	MODE D'EMPLOI	46
IT	LIBRETTO D'ISTRUZIONI	68
JP	取扱説明書	89
SC	用户使用手册	111
US	USER INSTRUCTIONS	129
	FCC AND ISED STATEMENTS	148



IMPORTANT SAFETY INFORMATION

Read these pages carefully before you start using your charger.

-  Keep the charger and other small parts away from children, pets, and mentally disabled people.
-  Never expose the charger to temperatures above 60° C (140° F), to prolonged sunlight, open flames or ignition sources.
-  Place the charger upright on a flat, stable surface when charging, with adequate space around the charger. Do not cover or place near flammable substances. This also applies when using a power bank.
-  Never try to open or repair the charger yourself. Contact your hearing care professional if you experience defects.
-  Use only a Widex charger with your hearing aids. Use of a charger not recommended by WIDEX A/S may compromise the system or result in dangerous situations.
-  Never leave the charger in direct sunlight and do not immerse it in water.
-  Never insert other objects than your hearing aids in the charging wells.
-  Use only a Widex power adapter and cable with your charger.

YOUR CHARGER

Welcome

Thank you for choosing this product. Your new WIDEX MOMENT™CHARGE n CLEAN charger is intended to detect, charge and maintain your WIDEX MOMENT™MRR2D hearing aid.

Read these instructions carefully before you start using this device.

NOTE

Your charger may not look exactly like the one illustrated in this booklet. We reserve the right to make any changes we consider necessary.

The charger at a glance

The charger consists of a charging unit for each hearing aid, a maintenance compartment for the receivers and a light indicator with three indicator lights that show the charging status of the hearing aids and the status of the maintenance cycle.

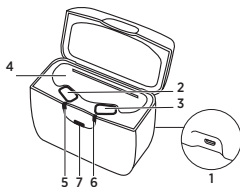

1. Micro USB port
2. Left hearing aid charging well
3. Right hearing aid charging well
4. Maintenance compartment for the receivers
5. Left hearing aid charging indicator light
6. Right hearing aid charging indicator light
7. Maintenance indicator light

Operating, storage and transport conditions

Your charger is designed for indoor use. It is sensitive to extreme conditions such as high temperatures, and it should not be operated, stored or transported in direct sunlight.

Operate the charger within the following conditions:

	Minimum	Maximum
Temperature	0° C (32° F)	35° C (95° F)
Humidity	20% rH	75% rH

Store and transport the charger within the following conditions:

	Minimum	Maximum
Temperature	-20° C (-4° F)	60° C (140° F)
Humidity	5% rH	90% rH
Atmospheric pressure	750 mbar	1060 mbar

You can find technical data sheets and additional information on your charger on <https://global.widex.com>.

OPERATING THE CHARGER

Getting ready for use

Power supply

For optimal operation, connect your charger to the mains and use only the included cable and power supply.

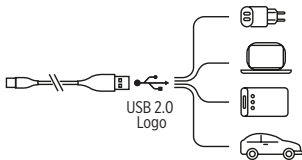

Please make sure that the USB port is USB 2.0 compatible.

Connect the cable to the charger:

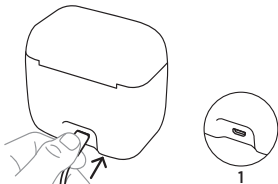

Power on

When the charger is connected to the power supply, the indicator lights **flash white 5 times** and then turn off:

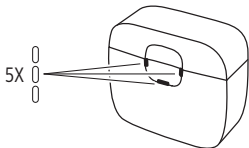

The charger is now in standby mode and ready to charge your hearing aid.

Charging the hearing aid

Gently place your hearing aids in their respective charging wells and the receivers in the maintenance compartment. The hearing aids turn off automatically. **Then close the lid.**

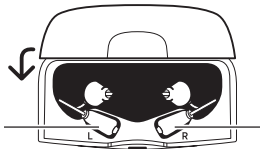

Left hearing aid

Right hearing aid

When connected to the power supply, the charger can charge two hearing aids simultaneously. Depending on the state of the hearing aids, each hearing aid can also be charged individually. If one hearing aid is fully charged and placed in the charger, it will not charge, but the other hearing aid, which is not fully charged, will be charged.

Charging your hearing aid fully will take approximately **4 hours**. If you charge your hearing aid for half an hour, you will have approximately 4 hours of use.

While charging the hearing aids, the maintenance (Ultraviolet-C treatment and drying) is carried out. The maintenance cycle takes 30 minutes.

Charging indicators

While the charger is detecting the hearing aid, the light indicator turns **solid yellow**:

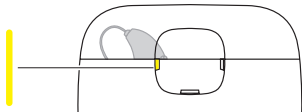

Once the charger has detected the hearing aid, the charging will begin.

The light indicator will **flash green** to indicate that the hearing aid is low on battery and less than **40% charged**:

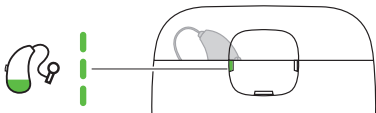

The light indicator will **glow green** to indicate that the hearing aid is more than **40% charged**:

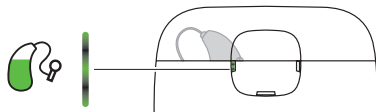

The light indicator will **turn solid green** to indicate that the hearing aid is **100% charged**:

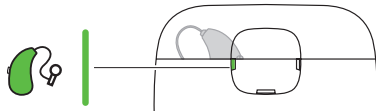

After charging

Avoid removing the hearing aids from the charging wells by pulling the earwire, as this could damage the connection between the earwire and the hearing aid. Instead, put your fingers around the hearing aid when removing it from the charger.

When you remove the hearing aid from the charger, the hearing aid turns on after a few seconds. Remember to turn it off if you are not going to use it right away.

Immediately after charging, the hearing aid may temporarily feel warm. If you are not comfortable with this, wait a few minutes for the hearing aid to reach room temperature, before putting the hearing aid on.

Maintenance

The light indicator will **flash white** to indicate that the maintenance cycle is in progress (Ultraviolet-C treatment or drying):

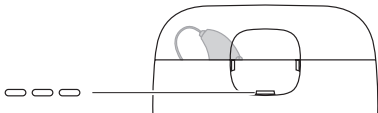

The light indicator turns **solid white** to indicate the end of the maintenance cycle:

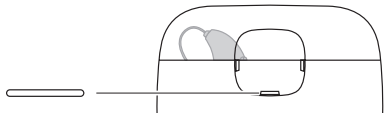

If the lid is opened during the maintenance cycle, the cycle is paused but the charging continues. The maintenance cycle will restart when the lid is closed.





Maintenance pause
(**solid yellow** light)

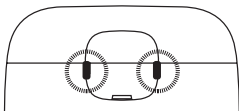

Overview of indicator lights

Charging



Indicator lights	Status
Solid yellow 	The charger is detecting the hearing aid.
Flashing green 	The hearing aid is charging. Low battery, less than 40%.
Glowing green 	The hearing aid is charging. Battery more than 40%.
Solid green 	The hearing aid is fully charged. Battery 100%.
One indicator flashing red 	An error occurred during charging and the charging has stopped. See Troubleshooting.

Indicator lights

Status

Both indicators flashing red



An error occurred during charging and the charging has stopped.
See Troubleshooting.

Flashing yellow



The temperature of the hearing aid has become too high during charging and charging is paused.
See Troubleshooting.

Maintenance

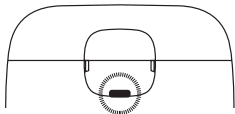

Indicator lights

Status

Flashing white



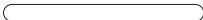

The maintenance cycle is in progress (Ultraviolet-C treatment or drying).

Solid white



The maintenance cycle is complete.

Indicator lights	Status
Solid yellow 	The maintenance cycle is paused but the charging cycle continues.
Flashing red 	An error occurred during the maintenance and the cycle has stopped. See Troubleshooting.
Flashing yellow 	The maintenance cycle is paused due to overheating (fan still running). See Troubleshooting.

Cleaning

The charger does not generally require cleaning. If necessary, carefully wipe off the charger with a soft dry cloth.

If you notice any dust in the charging well, gently blow it clean. If this is not enough, gently clean the charging well with a cotton bud.

To remove earwax from the charger, carefully wipe with a soft cloth with a bit of mild household detergent.





Never use sharp/pointy objects to clean the charger.

TROUBLESHOOTING

These pages contain advice on what to do if your charger does not work as expected.

Light indicators	Possible cause	Solution
No lights	The charger is not connected.	Make sure that the USB cable is correctly connected to the charger and a USB 2.0 compatible USB port or plug the USB cable into the wall socket using the included power adaptor.
	The hearing aid is not placed correctly in the charger.	Place the hearing aid correctly in the charger.
Right and/or left indicators flashing yellow 	The temperature of your surroundings or of the hearing aid exceeds a critical limit and the charging is paused.	The charging will continue when the temperature of your surroundings or the hearing aid has dropped. If this happens continually, find a cooler place to charge your hearing aid.

Light indicators	Possible cause	Solution
Right or left indicator flashing red 	The charger cannot recognise the hearing aid. The hearing aid has a critical error.	Remove the incompatible hearing aid. Remove the hearing aid, disconnect from the power for 10 seconds and then try again. If the charger is still flashing red, contact your hearing care professional.
Central indicator flashing red 	The maintenance cycle has a critical error.	Remove the hearing aid, disconnect from the power for 10 seconds and then try again. If the charger is still flashing red, contact your hearing care professional.
Right and left indicators flashing red 	The charger has a critical error.	Remove the hearing aid, disconnect from the power for 10 seconds and then try again. If the charger is still flashing red, contact your hearing care professional.

REGULATORY INFORMATION

Intended use

The WIDEX charger WPC101 model is to be used for charging the WIDEX MOMENT™MRR2D hearing aid.

EU directives

Directive 2014/53/EU

Hereby, WSAUD A/S declares that the WPC101 is in compliance with the essential requirements and other relevant provisions of Directive 2014/53/EU.

The WPC101 contains a radio transmitter operating at: 6.78 MHz, 13.4 dB μ A/m @ 3 m.

A copy of the Declaration of Conformity according to 2014/53/EU can be found at

<https://global.widex.com/doc>



N26346

Information regarding disposal

Do not dispose of hearing aids, hearing aid accessories and chargers with ordinary household waste.

Hearing aids, hearing aid accessories and chargers should be disposed of at sites intended for electrical waste and electronic equipment, or given to your hearing care professional for safe disposal.

For returning or shipping the devices, please contact your hearing care professional.

FCC and ISED statements

Federal Communications Commission Statement



This device complies with part 15/part 18 of the FCC Rules. Operation is subject to the following two conditions:

- (1) This device may not cause harmful interference, and
- (2) this device must accept any interference received, including interference that may cause undesired operation.

NOTE:

This equipment has been tested and found to comply with the limits for a Class B digital device, pursuant to part 15 of the FCC Rules. These limits are designed to provide reasonable protection against harmful interference in a residential installation. This equipment generates, uses and can radiate radio frequency energy and, if not installed and used in accordance with the instructions, may cause harmful interference to radio communications. However, there is no guarantee that interference will not occur in a particular installation. If this equipment does cause harmful inter-

ference to radio or television reception, which can be determined by turning the equipment off and on, the user is encouraged to try to correct the interference by one or more of the following measures:

- Reorient or relocate the receiving antenna.
- Increase the separation between the equipment and receiver.
- Connect the equipment into an outlet on a circuit different from that to which the receiver is connected.
- Consult the dealer or an experienced radio/TV technician for help.

NOTE:

This equipment complies with FCC radiation exposure limits set forth for an uncontrolled environment. This transmitter must not be co-located or operating in conjunction with any other antenna or transmitter.

Changes or modifications to the equipment not expressly approved by WSAUD A/S could void the user's authority to operate the equipment.

ISED Statement / Déclaration d'ISED

CAN RSS-216/CNR-216

CAN ICES-1/NMB-1

This device contains licence-exempt transmitter(s)/receiver(s) that comply with Innovation, Science and Economic Development Canada's licence-exempt RSS(s). Operation is subject to the following two conditions:

- (1) This device may not cause interference.

(2) This device must accept any interference, including interference that may cause undesired operation of the device.

L'émetteur/recepteur exempt de licence contenu dans le present appareil est conforme aux CNR d'Innovation, Sciences et Developpement economique Canada applicables aux appareils radio exempts de licence. L'exploitation est autorisee aux deux conditions suivantes:

(1) L'appareil ne doit pas produire de brouillage;

(2) L'appareil doit accepter tout brouillage radioelectrique subi, meme si le brouillage est susceptible d'en compromettre le fonctionnement.

ISED RADIATION EXPOSURE STATEMENT:





This equipment complies with ISED RF radiation exposure limits set forth for an uncontrolled environment. This transmitter must not be co-located or operating in conjunction with any other antenna or transmitter.





ISED EXPOSITION AUX RADIATIONS:

Cet equipement est conforme avec ISED les limites d'exposition aux rayonnements defini es pour un controle environnement. Cet emetteur ne doit pas etre co-localises ou fonctionner en conjonction avec une autre antenne ou emetteur.

SYMBOLS

Symbols commonly used by WSAUD A/S in medical device labelling (labels/IFU/etc.)

Symbol	Title/Description
	Manufacturer The product is produced by the manufacturer whose name and address are stated next to the symbol. If appropriate, the date of manufacture may also be stated.
	Catalogue number The product's catalogue (item) number.
	Consult instructions for use The user instructions contain important cautionary information (warnings/precautions) and must be read before using the product.
	Warning Text marked with a warning symbol must be read before using the product.
	WEEE mark "Not for general waste". When a product is to be discarded, it must be sent to a designated collection point for recycling and recovering to prevent the risk of harm to the environment or human health as a result of the presence of hazardous substances.

Symbol	Title/Description
	CE mark The product is in conformity with the requirements set out in European CE marking directives.
	RCM mark The product complies with electrical safety, EMC and radio spectrum regulatory requirements for products supplied to the Australian or New Zealand markets.
	FCC logo The product is compliant with relevant USA 47 CFR Rules. FCC – Federal Communications Commission.
	Medical device Indication that the device is a medical device.

INFORMACIÓN DE SEGURIDAD IMPORTANTE

Lea atentamente estas páginas antes de empezar a utilizar el cargador.



Mantenga el cargador y otras partes pequeñas fuera del alcance de niños, mascotas y personas con discapacidad mental.



Nunca exponga el cargador a temperaturas superiores a 60 °C (140 °F), a la luz solar prolongada, a llamas al descubierto o a fuentes de ignición.



A la hora de utilizar el cargador, colóquelo en posición vertical sobre una superficie plana y estable, y con espacio suficiente a su alrededor. No lo cubra ni lo coloque cerca de materiales inflamables. Siga lo indicado también al usar una batería externa.



Nunca intente desmontarlo ni repararlo usted mismo. Póngase en contacto con su audioprotesista si el dispositivo presenta defectos.



Utilice solo un cargador Widex para sus audífonos. El uso de un cargador no recomendado por WIDEX A/S, puede poner en riesgo el sistema o dar lugar a situaciones peligrosas.



Nunca deje el cargador bajo la luz solar directa y nunca lo sumerja en agua.



Nunca introduzca otros objetos que no sean los audífonos en los orificios de carga.



Use solo un cable y adaptador de alimentación Widex con su cargador.

SU CARGADOR

Bienvenido

Gracias por elegir este producto. Su nuevo cargador WIDEX MOMENT™ CHARGE n CLEAN está diseñado para detectar, cargar y mantener su modelo de audífono WIDEX MOMENT™ MRR2D.

Lea atentamente estas instrucciones antes de empezar a utilizar el dispositivo.

NOTA

Es posible que el cargador no sea exactamente igual al que se muestra en este folleto. Nos reservamos el derecho de hacer los cambios que consideremos necesarios.

Características principales del cargador

El cargador consta de una unidad de carga para cada audífono, un compartimiento de mantenimiento para los auriculares y un indicador de luz con tres luces indicadoras que muestran el estado de carga de los audífonos y el estado del ciclo de mantenimiento.

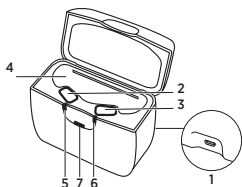

1. Puerto micro USB
2. Orificio de carga para audífono izquierdo
3. Orificio de carga para audífono derecho
4. Compartimiento de mantenimiento para los auriculares
5. Luz indicadora de carga para audífono izquierdo
6. Luz indicadora de carga para audífono derecho
7. Luz indicadora de mantenimiento

Condiciones de funcionamiento, almacenamiento y transporte

Su cargador está diseñado para su uso en interiores. Es sensible a condiciones extremas, como las altas temperaturas, y no se debe utilizar, almacenar ni transportar bajo la luz solar directa.

Utilice el cargador en las siguientes condiciones:

	Mínima	Máxima
Temperatura	0° C (32° F)	35° C (95° F)
Humedad	20 % de HR	75 % de HR

Guarde y transporte el cargador en las siguientes condiciones:

	Mínima	Máxima
Temperatura	-20 °C (-4 °F)	60 °C (140 °F)
Humedad	5 % de HR	90 % de HR
Presión atmosférica	750 mbar	1060 mbar

Puede encontrar fichas técnicas e información adicional sobre el cargador en <https://global.widex.com>.

FUNCIONAMIENTO DEL CARGADOR

Preparación para su uso

Alimentación

Para lograr un funcionamiento óptimo, conecte el cargador a la red eléctrica y use solo el cable suministrado.

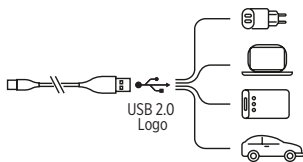

Asegúrese de que el puerto USB admite USB 2.0.

Conecte el cable al cargador:

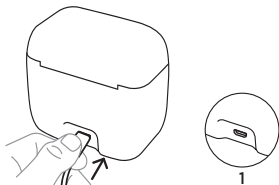

Encendido

Cuando el cargador está conectado a la fuente de alimentación, las luces indicadoras **parpadean en blanco cinco veces** y luego se apagan:

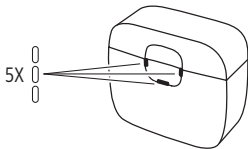

El cargador ya está en modo de reposo y listo para cargar el audífono.

Cómo cargar el audífono

Con cuidado, coloque cada audífono en su orificio de carga correspondiente y los auriculares en el compartimiento de mantenimiento. Los audífonos se apagarán automáticamente. **A continuación, cierre la tapa.**

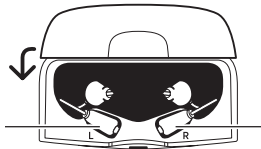

Audífono iz-
quierdo

Audífono derecho

Al conectarlo a la fuente de alimentación, el cargador puede cargar ambos audífonos al mismo tiempo. Además, cada audífono se puede cargar por separado, según el estado de carga de cada uno de ellos. Es decir, si coloca en el cargador un audífono completamente cargado, no se cargará. Sin embargo, si el otro audífono ya no tiene batería, sí se cargará.

El audífono tarda unas **4 horas** en cargarse por completo. Si carga el audífono media hora, tendrá aproximadamente cuatro horas de uso.

Mientras se cargan los audífonos, se lleva a cabo el mantenimiento (secado y tratamiento ultravioleta-C). El ciclo de mantenimiento tarda media hora en completarse.

Indicadores de carga

Mientras el cargador detecta el audífono, el indicador de luz se vuelve **amarillo fijo**:

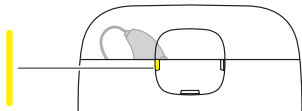

Una vez que el cargador haya detectado el audífono, comenzará a cargarlo.

El indicador de luz **parpadeará en verde** para indicar que el audífono tiene poca batería y con menos de un **40 % de carga**:

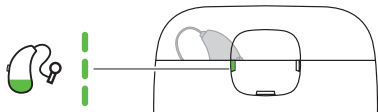

El indicador de luz **se iluminará en verde** para indicar que el audífono tiene más de un **40 % de carga**:

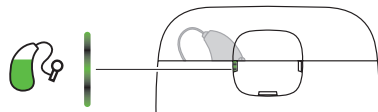

El indicador de luz **se volverá verde fijo** para indicar que el audífono tiene un **100 % de carga**:

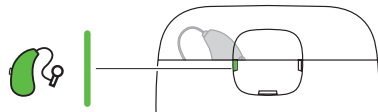

Después de la carga

Evite retirar los audífonos de los orificios de carga tirando del tubo earwire, ya que se podría dañar la conexión entre el audífono y dicho tubo. Lo correcto es colocar los dedos alrededor del audífono al retirarlo del cargador.

Cuando retire el audífono del cargador, el audífono se encenderá después de unos segundos. Recuerde apagarlo en caso de no utilizarlo de inmediato.

Inmediatamente después de la carga, quizá note que el audífono está caliente unos minutos. Si no se siente cómodo poniéndoselo así, espere un poco, hasta que el audífono alcance la temperatura ambiente.

Mantenimiento

El indicador de luz **parpadeará en blanco** para indicar que el ciclo de mantenimiento está en curso (secado o tratamiento ultravioleta-C):

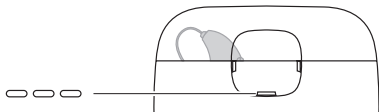

El indicador de luz pasa a mostrar una luz **blanca fija** para señalar que el ciclo de mantenimiento ha finalizado:

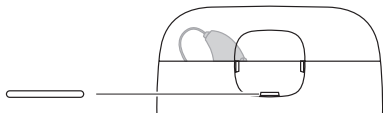

Si abre la tapa durante el ciclo de mantenimiento, el ciclo se detiene pero la carga continúa. El ciclo de mantenimiento se reiniciará al cerrar la tapa.





Mantenimiento en
pausa (luz **amarilla
fija**)

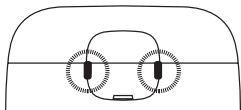

Descripción general de las luces del indicador

Carga

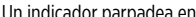

Luces indicadores	Estado
Amarillo fijo 	El cargador detecta el audífono.
Verde parpadeante 	El audífono se está cargando. Batería baja, menos del 40 %.
Verde encendido 	El audífono se está cargando. Batería con carga superior al 40 %.
Verde fijo 	El audífono está completamente cargado. Batería con carga completa.
Un indicador parpadea en rojo 	Se ha producido un error durante la carga y esta se ha detenido. Ver resolución de problemas.

Luces indicadoras

Estado

Ambos indicadores parpadean en rojo



Se ha producido un error durante la carga y esta se ha detenido.
Ver resolución de problemas.

Amarillo parpadeante



La temperatura del audífono ha aumentado demasiado durante la carga y esta se ha interrumpido.
Ver resolución de problemas.

Mantenimiento

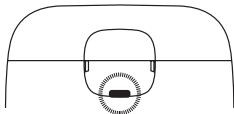

Luces indicadoras

Estado

Blanco parpadeante



El ciclo de mantenimiento está en curso (secado o tratamiento ultravioleta-C).

Blanco fijo



Se ha completado el ciclo de mantenimiento.

Luces indicadoras

Estado

Amarillo fijo



Se ha detenido el ciclo de mantenimiento, pero la carga continúa.

Rojo parpadeante



Se ha producido un error durante el mantenimiento y el ciclo se ha detenido.
Ver resolución de problemas.

Amarillo parpadeante



El ciclo de mantenimiento se ha detenido debido a un sobrecalentamiento (el ventilador sigue funcionando).
Ver resolución de problemas.

Limpieza

Por lo general, el cargador no necesita limpieza. Si es necesario, límpielo cuidadosamente con un paño suave y seco.

Si observa polvo en el orificio de carga, soplelo con suavidad. Si esto no es suficiente, limpie cuidadosamente el orificio de carga con un bastoncillo de algodón.

Para quitar el cerumen del cargador, límpielo con cuidado usando un paño suave y un poco de detergente doméstico que no sea agresivo.





Nunca utilice objetos afilados ni puntiagudos para limpiar el cargador.

RESOLUCIÓN DE PROBLEMAS

Estas páginas contienen consejos sobre qué hacer si el cargador no funciona como se espera.

Indicadores de luz	Posible causa	Solución
No hay luz	El cargador no está conectado.	Asegúrese de que el cable USB está correctamente conectado al cargador y de que el puerto USB admita USB 2.0 o conecte el cable USB a la toma de corriente usando el adaptador de cable incluido.
	El audífono no está bien colocado en el cargador.	Coloque el audífono correctamente en el cargador.
El indicador izquierdo/ derecho, o ambos, parpadea(n) en amarillo 	La temperatura del entorno o del audífono supera un límite crítico y se interrumpe la carga.	La carga continuará cuando la temperatura del entorno o del audífono haya disminuido. Si esto sucede frecuentemente, busque un lugar más fresco para cargar el audífono.

Indicadores de luz	Posible causa	Solución
El indicador derecho o el izquierdo parpadea en rojo 	El cargador no puede reconocer el audífono. El audífono presenta un error crítico.	Retire el audífono incompatible. Retire el audífono, desconéctelo diez segundos de la fuente de alimentación y vuelva a intentarlo. Si el cargador sigue parpadeando en rojo, póngase en contacto con su audioprotesista.
El indicador del centro parpadeando en rojo 	El ciclo de mantenimiento presenta un error crítico.	Retire el audífono, desconéctelo diez segundos de la fuente de alimentación y vuelva a intentarlo. Si el cargador sigue parpadeando en rojo, póngase en contacto con su audioprotesista.

Indicadores de luz	Posible causa	Solución
El indicador derecho y el izquierdo parpadeando en rojo 	El cargador presenta un error crítico.	Retire el audífono, desconéctelo diez segundos de la fuente de alimentación y vuelva a intentarlo. Si el cargador sigue parpadeando en rojo, póngase en contacto con su audioprotesista .

INFORMACIÓN REGLAMENTARIA

Uso previsto

El modelo WPC101 del cargador Widex se debe utilizar para cargar el audífono WIDEX MOMENT™MRR2D.

Directivas de la Unión Europea

Directiva 2014/53/UE

Por medio de la presente, WSAUD A/S declara que el modelo WPC101 cumple los requisitos esenciales y otras disposiciones aplicables de la Directiva 2014/53/UE.

El modelo WPC101 tiene integrado un transmisor de radio que funciona a: 6,78 MHz, 13,4 dB μ A/m a 3 m.

Puede consultar una copia de la Declaración de conformidad según la Directiva 2014/53/UE en:

<https://global.widex.com/doc>



N26346

Información sobre cómo desechar el dispositivo





No deseche los audífonos, los accesorios de audífonos ni los cargadores con los residuos domésticos.

Los audífonos, los accesorios de audífonos y los cargadores deben desecharse en sitios aptos para residuos de aparatos eléctricos y electrónicos, o deben entregarse a un profesional de la audición para su eliminación segura.

Si desea devolver o enviar los dispositivos, póngase en contacto con su profesional de la audición.

SÍMBOLOS

Estos son los símbolos utilizados habitualmente por WSAUD A/S para el etiquetado de los productos sanitarios (etiquetas, instrucciones de uso, etc.)

Símbolo	Denominación/Descripción
	Fabricante El producto pertenece al fabricante cuyo nombre y dirección aparecen junto al símbolo. Si procede, también se indica la fecha de fabricación.
	Número de catálogo El número de catálogo (artículo) del producto.
	Consulte las instrucciones de uso Las instrucciones de uso incluyen información preventiva importante (advertencias y precauciones) y deben leerse antes de usar el producto.
	Advertencia Antes de usar el producto, se debe leer todo el texto marcado con un símbolo de advertencia.
	Marca WEEE “No tire el dispositivo a la basura”. A la hora de desechar un producto, se debe enviar a un punto de recogida específico para su reciclaje y recuperación a fin de evitar el riesgo de dañar el medioambiente o la salud humana debido a la presencia de sustancias peligrosas.

Símbolo	Denominación/Descripción
	<p>Marca CE El producto cumple con los requisitos establecidos en las directivas europeas de marcado CE.</p>
	<p>Marca RCM El producto cumple con los requisitos normativos de seguridad eléctrica, compatibilidad electromagnética y bandas de frecuencia para productos suministrados a los mercados de Australia y Nueva Zelanda.</p>
	<p>Logotipo de FCC El producto cumple con las normas pertinentes del CFR, título 47, de Estados Unidos. Comisión Federal de Telecomunicaciones (FCC).</p>
	<p>Producto sanitario Indicación de que el dispositivo es un producto sanitario.</p>

INFORMATIONS DE SÉCURITÉ IMPORTANTES

Veillez lire attentivement ces pages avant de commencer à utiliser votre chargeur.



Conservez le chargeur et les autres petits composants hors de portée des enfants, des animaux domestiques et des personnes handicapées mentales.



N'exposez jamais le chargeur à des températures supérieures à 60° C (140° F), au soleil pendant une période prolongée, à des flammes nues ou à d'autres sources d'inflammation.



Placez le chargeur à la verticale sur une surface plane et stable pendant le chargement en veillant à ce qu'il y ait suffisamment d'espace autour du chargeur. Ne le recouvrez pas et ne le placez pas près de substances inflammables. Cela vaut également lors de l'utilisation d'un Power bank.



N'essayez jamais d'ouvrir ou de réparer vous-même le chargeur. Contactez votre audioprothésiste si vous constatez des anomalies.



Utilisez uniquement un chargeur Widex avec vos aides auditives. L'utilisation d'un chargeur non recommandé par WIDEX A/S pourrait compromettre le système ou provoquer des situations dangereuses.



Ne laissez jamais le chargeur en plein soleil et ne l'immergez pas dans l'eau.



Ne mettez jamais d'autres objets que vos aides auditives dans les socles de recharge.



Utilisez uniquement un adaptateur et câble Widex avec votre chargeur.

VOTRE CHARGEUR

Bienvenue

Merci d'avoir choisi ce produit. Votre nouveau chargeur WIDEX MOMENT™ Le chargeur CHARGE n CLEANest destiné à détecter, recharger et entretenir votre modèle d'aide auditive WIDEX MOMENT™ MRR2D.

Lisez attentivement ces instructions avant de commencer à utiliser cet appareil.

REMARQUE

Votre chargeur n'est peut-être pas exactement identique à celui représenté dans ce mode d'emploi. Nous nous réservons le droit d'apporter toutes modifications que nous jugerons nécessaires.

Le chargeur en bref

Le chargeur se compose d'une unité de chargement pour chaque aide auditive, d'un compartiment d'entretien pour les écouteurs et d'un indicateur lumineux avec trois voyants qui indiquent l'état de charge des aides auditives et le statut du cycle d'entretien.

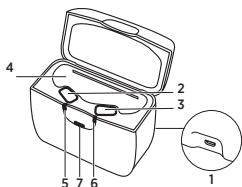

1. Micro port USB
2. L'aide auditive gauche se recharge bien
3. L'aide auditive droite se recharge bien
4. Compartiment d'entretien pour les écouteurs
5. Voyant indiquant que l'aide auditive gauche est en charge
6. Voyant indiquant que l'aide auditive droite est en charge
7. Voyant indiquant l'entretien

Conditions de fonctionnement, de stockage et de transport

Votre chargeur est conçu pour être utilisé à l'intérieur. Il est sensible aux conditions extrêmes, telles que les températures élevées, et ne devrait pas être utilisé, stocké ou transporté en plein soleil.

Utilisez le chargeur selon les conditions suivantes :

	Minimum	Maximum
Température	0° C (32° F)	35° C (95° F)
Humidité	20 % HR	75 % HR

Stockez et transportez le chargeur selon les conditions suivantes :

	Minimum	Maximum
Température	-20° C (-4° F)	60° C (140° F)
Humidité	5 % HR	90 % HR
Pression atmosphérique	750 mbar	1060 mbar

Vous trouverez des fiches techniques et davantage d'informations sur votre chargeur sur <https://global.widex.com>.

UTILISATION DU CHARGEUR

Se préparer à l'utiliser

Bloc d'alimentation

Pour un fonctionnement optimal, connectez votre chargeur sur secteur et utilisez uniquement le câble et le bloc d'alimentation inclus.

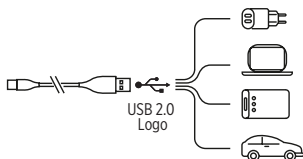

Veillez vous assurer que le port USB est compatible avec USB 2.0.

Connectez le câble au chargeur :

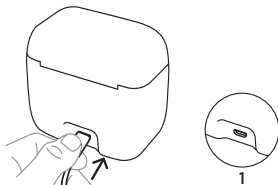

Marche

Lorsque le chargeur est connecté au bloc d'alimentation, les voyants lumineux **clignotent d'une lumière blanche 5 fois** puis s'éteignent :

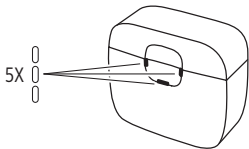

Le chargeur est alors en mode veille et prêt à recharger votre aide auditive.

Chargement de l'aide auditive

Placez précautionneusement vos aides auditives dans leurs socles de recharge respectifs et les écouteurs dans le compartiment d'entretien. Les aides auditives s'éteignent automatiquement. **Puis fermez le couvercle.**

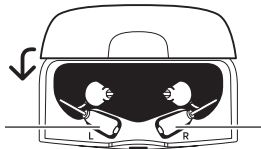

Aide auditive
gauche

Aide auditive droite

Lorsque vous êtes connecté au bloc d'alimentation, le chargeur peut charger deux aides auditives simultanément. Selon l'état de chargement des aides auditives, chaque aide auditive peut également être rechargée séparément. Si une aide auditive est entièrement chargée et placée dans le chargeur, elle ne se rechargera pas, mais l'autre aide auditive, qui n'est pas totalement chargée, sera rechargée.

Le chargement complet de votre aide auditive prendra environ **4 heures**. Si vous rechargez votre aide auditive pendant une demi-heure, vous pourrez l'utiliser pendant environ 4 heures.

L'entretien (traitement par ultraviolets-C et séchage) a lieu pendant le chargement des aides auditives. Le cycle d'entretien prend 30 minutes.

Voyants de recharge

Pendant que le chargeur détecte l'aide auditive, le voyant est **jaune constant** :

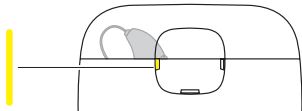

Le chargement débutera lorsque le chargeur aura détecté l'aide auditive.

Le voyant **clignotera d'une lumière verte** pour indiquer que le niveau de la pile de l'aide auditive est faible et inférieur à **40 %** :

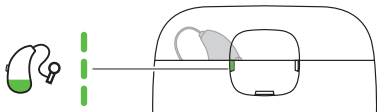

Le voyant **s'allumera d'une lumière verte** pour indiquer que le niveau de la pile de l'aide auditive est supérieur à **40 %** :

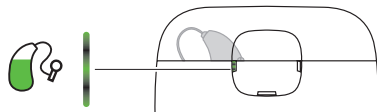

Le voyant **s'allumera d'une lumière verte constante** pour indiquer que le niveau de la pile de l'aide auditive est à **100 %** :

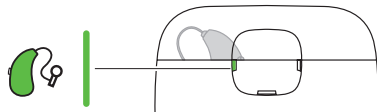

Après le chargement

Évitez de retirer les aides auditives des socles du chargeur en tirant sur le fil fin (earwire), car cela pourrait endommager la connexion entre le fil et l'aide auditive. Il est recommandé de prendre l'aide auditive entre vos doigts pour la retirer du chargeur.

Lorsque vous retirez l'aide auditive du chargeur, l'aide auditive s'allume après quelques secondes. N'oubliez pas de l'éteindre si vous n'avez pas l'intention de l'utiliser immédiatement.

Immédiatement après le chargement, il se peut que l'aide auditive soit temporairement chaude. Si vous trouvez que cela n'est pas agréable, attendez quelques minutes, afin que l'aide auditive retrouve une température ambiante avant de l'installer sur votre oreille.

L'entretien

Le voyant **clignote blanc** pour indiquer que le cycle d'entretien est en cours (traitement par ultraviolets-C ou séchage) :

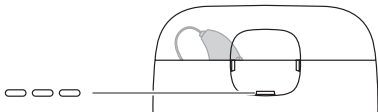

Le voyant est **blanc constant** pour indiquer la fin du cycle d'entretien :

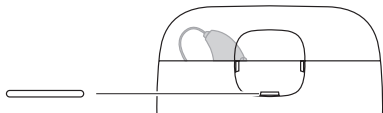

Si vous ouvrez le couvercle pendant le cycle d'entretien, le cycle est mis en pause, mais le chargement continue. Le cycle d'entretien redémarrera lorsque le couvercle sera fermé.





Mise en pause de
l'entretien (voyant
jaune constant)

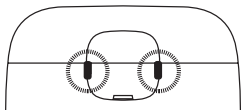

Vue d'ensemble des voyants

Chargement



Voyants	État
Jaune constant 	Le chargeur est en train de détecter l'aide auditive.
Vert clignotant 	L'aide auditive est en charge. Pile faible, niveau inférieur à 40 %.
Vert/rouge 	L'aide auditive est en charge. Niveau de la pile supérieur à 40 %.
Vert constant 	L'aide auditive est entièrement chargée. Pile 100 %.
Un voyant rouge clignotant 	Une erreur s'est produite lors du chargement et le chargement a été interrompu. Voir Dépannage.

Voyants

Les deux voyants sont rouges clignotants



État

Une erreur s'est produite lors du chargement et le chargement a été interrompu.

Voir Dépannage.

Jaune clignotant



La température de l'aide auditive est trop montée pendant le chargement et le chargement a été interrompu.

Voir Dépannage.

L'entretien

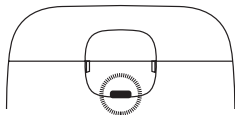

Voyants

Blanc clignotant

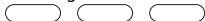

État

Le cycle d'entretien est en cours (traitement par ultraviolets-C ou séchage).

Blanc constant



Le cycle d'entretien est terminé.

Voyants

État

Jaune constant



Le cycle d'entretien est en pause mais le cycle de chargement continue.

Rouge clignotant



Une erreur est survenue pendant l'entretien et le cycle s'est arrêté. Voir Dépannage.

Jaune clignotant



Le cycle d'entretien est en pause en raison d'une surchauffe (ventilateur encore en cours de fonctionnement). Voir Dépannage.

Nettoyage

Le chargeur ne requiert généralement pas de nettoyage. Le cas échéant, essuyez soigneusement le chargeur avec un chiffon doux et sec.

Si vous remarquez de la poussière dans le socle du chargeur, faites-la disparaître en soufflant doucement. Si cela ne suffit pas, nettoyez délicatement le socle du chargeur avec un coton-tige.

Pour éliminer le cérumen du chargeur, essuyez-le soigneusement avec un chiffon doux imbibé d'un peu de détergent ménager doux.







N'utilisez jamais d'objets pointus/coupants pour nettoyer le chargeur.

DÉPANNAGE

Ces pages vous informent sur ce que vous pouvez faire si votre chargeur ne fonctionne pas comme prévu.

Voyants lumineux	Cause possible	Solution
Pas de voyants	Le chargeur n'est pas connecté.	Assurez-vous que le câble USB est correctement connecté au chargeur et à un port USB compatible avec USB 2.0 ou branchez le câble USB dans une prise murale en utilisant l'adaptateur électrique inclus.
	L'aide auditive n'est pas correctement positionnée dans le chargeur.	Placez correctement l'aide auditive dans le chargeur.

Voyants lumineux	Cause possible	Solution
Les voyants droit et/ou gauche clignotent d'une lumière jaune 	La température de la pièce ou de l'aide auditive dépasse une limite critique et le chargement a été interrompu.	Le chargement reprendra lorsque la température de la pièce ou de l'aide auditive aura chuté. Si cela se produit régulièrement, trouvez un endroit plus frais pour recharger votre aide auditive.
Le voyant droit ou gauche clignote rouge 	Le chargeur ne reconnaît pas l'aide auditive. L'aide auditive présente une erreur critique.	Enlevez l'aide auditive incompatible. Retirez l'aide auditive, déconnectez le chargeur de la source électrique pendant 10 secondes, puis réessayez. Si le chargeur continue à clignoter d'une lumière rouge, contactez votre audioprothésiste.

Voyants lumineux	Cause possible	Solution
Le voyant central clignoterouge 	Le cycle d'entretien présente une erreur critique.	Retirez l'aide auditive, déconnectez le chargeur de la source électrique pendant 10 secondes, puis réessayez. Si le chargeur continue à clignoter d'une lumière rouge, contactez votre votre audioprothésiste.
Les voyants droit et gauche clignote rouge 	Le chargeur présente une erreur critique.	Retirez l'aide auditive, déconnectez le chargeur de la source électrique pendant 10 secondes, puis réessayez. Si le chargeur continue à clignoter d'une lumière rouge, contactez votre votre audioprothésiste.

INFORMATIONS RÉGLEMENTAIRES

Usage auquel cet appareil est destiné

Vous devez utiliser le chargeur modèle WPC101 de Widex pour le chargement de l'aide auditive l'aide auditive WIDEX MOMENT™MRR2D.

Directives UE

Directive 2014/53/UE

Par la présente, WSAUD A/S déclare que l'appareil WPC101 est conforme aux exigences essentielles et autres dispositions pertinentes de la Directive 2014/53/UE.

Le WPC101 comprend un émetteur radio fonctionnant à : 6,78 MHz, 13,4 dB μ A/m à 3 m.

Une copie de la Déclaration de conformité à la Directive 2014/53/UE peut être consultée sur

<https://global.widex.com/doc>



N26346

Informations concernant l'élimination

Ne mettez pas les aides auditives, accessoires d'aides auditives et chargeurs au rebut avec les ordures ménagères.

Les aides auditives, accessoires d'aides auditives et chargeurs doivent être mis au rebut dans des endroits prévus pour des déchets d'équipements électriques et électroniques ou bien remis à votre audioprothésiste pour une mise au rebut en toute sécurité.

Pour le retour ou l'envoi des appareils, veuillez contacter votre audioprothésiste.

SYMBOLES

Symboles communément utilisés par WSAUD A/S pour l'étiquetage des dispositifs médicaux (étiquettes/Mode d'emploi/etc.)

Symbole

Titre/Description



Fabricant

Le produit est fabriqué par le fabricant dont le nom et l'adresse sont indiqués à côté du symbole. Si besoin, la date de fabrication peut également être indiquée.



Référence du produit

Référence du produit (article).



Veillez consulter le mode d'emploi

Le mode d'emploi comprend des informations importantes (avertissements/précautions). Il est impératif de le lire attentivement avant d'utiliser le produit.







Avertissement

Lisez attentivement le texte marqué d'un symbole d'avertissement avant d'utiliser le produit.











Marque DEEE

« Ne pas jeter avec les déchets ordinaires ». Lorsque vous devez jeter un produit, il doit être rapporté à un point de collecte agréé pour ce recyclage et cette destruction afin d'éviter les risques de pollution environnementale ou de nuisance à la santé humaine par la présence de substances dangereuses.

Symbole	Titre/Description
	<p>Marquage CE Le produit est conforme aux exigences fixées par les directives européennes de marquage CE.</p>
	<p>Marque RCM Le produit est conforme aux normes de sécurité électrique, à la CEM et aux exigences réglementaires en matière de spectre des radiofréquences pour les produits vendus sur les marchés australien ou néo-zélandais.</p>
	<p>Logo FCC Le produit est conforme aux règlements américains 47 CFR. FCC - Commission Fédérale des Communications</p>
	<p>Dispositif médical Indication que l'aide auditive est un dispositif médical.</p>

INFORMAZIONI IMPORTANTI SULLA SICUREZZA

Leggere attentamente queste pagine prima di iniziare a utilizzare il caricabatterie.

-  Tenere il caricatore e altri componenti di piccole dimensioni lontano da bambini, animali domestici e persone con disabilità mentali.
-  Non esporre mai il caricatore a temperature superiori a 60 °C (140 °F), alla luce solare prolungata, a fiamme libere o alle sorgenti di ignizione.
-  Collocare il caricatore in posizione verticale su una superficie piana e stabile durante la ricarica, con spazio sufficiente intorno al caricatore. Non coprire e non collocare vicino a sostanze infiammabili. Questo vale anche quando si utilizza un accumulatore di carica.
-  Non tentare mai di aprire o riparare il caricabatterie da soli. In caso di difetti, contattare il proprio audioprotesista.
-  Utilizzare solo un caricatore Widex con gli apparecchi acustici. L'uso di un caricatore non raccomandato da WIDEX A/S può compromettere il sistema o causare situazioni pericolose.
-  Non lasciare mai il caricabatterie esposto alla luce diretta del sole e non immergerlo in acqua.
-  Non inserire mai oggetti diversi dagli apparecchi acustici nei vani di ricarica.
-  Utilizzare solo un alimentatore e cavo Widex con il caricatore.

IL CARICATORE

Benvenuto

Grazie per aver scelto questo prodotto. Il nuovo caricatore WIDEX MOMENT™CHARGE n CLEAN ha lo scopo di rilevare e caricare l'apparecchio acustico WIDEX MOMENT™MRR2D.

Leggere con attenzione queste istruzioni prima di iniziare a utilizzare il dispositivo.

NOTA

Il caricabatterie potrebbe non avere esattamente l'aspetto illustrato in questo opuscolo. Ci riserviamo il diritto di apportare tutte le modifiche necessarie.

Panoramica del caricatore

Il caricatore è costituito da un'unità di carica per ciascun apparecchio acustico, un vano di manutenzione per i ricevitori e un indicatore luminoso con tre spie che mostrano lo stato di carica degli apparecchi acustici e lo stato del ciclo di manutenzione.

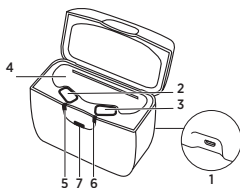

1. Porta Micro USB
2. Alloggiamento per la ricarica dell'apparecchio acustico sinistro
3. Alloggiamento per la ricarica dell'apparecchio acustico destro
4. Vano di manutenzione per i ricevitori
5. Spia di ricarica dell'apparecchio acustico sinistro
6. Spia di ricarica dell'apparecchio acustico destro
7. Spia di manutenzione

Condizioni di utilizzo, conservazione e trasporto

Il caricabatterie è progettato per l'uso in interni. È sensibile a condizioni estreme come le alte temperature e non deve essere azionato, conservato o trasportato alla luce diretta del sole.

Utilizzare il caricabatterie nelle seguenti condizioni:

	Minima	Massima
Temperatura	0 °C (32 °F)	35 °C (95 °F)
Umidità	20% UR	75% UR

Conservare e trasportare il caricatore nelle seguenti condizioni:

	Minima	Massima
Temperatura	-20 °C (4 °F)	60 °C (140 °F)
Umidità	5% UR	90% UR
Pressione atmosferica	750 mBar	1060 mBar

È possibile trovare le schede dei dati tecnici e informazioni aggiuntive sugli apparecchi acustici alla pagina <https://global.widex.com>.

UTILIZZO DEL CARICATORE

Preparazione all'uso

Alimentazione

Per un funzionamento ottimale, collegare il caricatore alla rete elettrica e usare solo l'alimentatore e il cavo in dotazione.

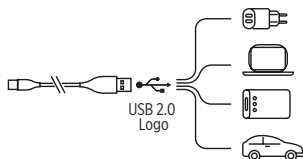

Verificare che la porta USB sia compatibile con USB 2.0.

Collegare il cavo al caricatore:

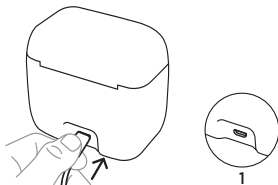

Accensione

Quando il caricatore è collegato all'alimentatore, le spie **lampeggiano in bianco 5 volte** e poi si spengono:

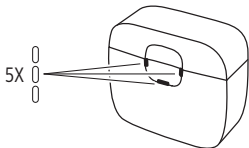

Il caricatore è ora in modalità standby e pronto a ricaricare l'apparecchio acustico.

Ricarica dell'apparecchio acustico

Collocare delicatamente gli apparecchi acustici nei rispettivi alloggiamenti di ricarica e i ricevitori nel vano di manutenzione. Gli apparecchi acustici si spengono automaticamente. **Quindi chiudere il coperchio.**

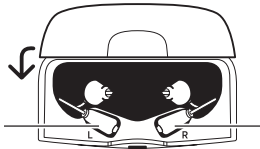

Apparecchio
acustico sinistro

Apparecchio acustico
destro

Quando è connesso all'alimentatore, il caricatore può caricare due apparecchi acustici contemporaneamente. Ciascun apparecchio acustico può essere caricato individualmente, a seconda del suo stato di carica. Se un apparecchio acustico è completamente carico e posto nel caricatore, non si ricaricherà, ma l'altro apparecchio acustico, non completamente carico, si ricaricherà.

La ricarica completa dell'apparecchio acustico richiederà circa **4 ore**. Ricaricando l'apparecchio acustico per mezz'ora, si avranno circa 4 ore di utilizzo.

Quando si ricaricano gli apparecchi acustici, viene eseguita la manutenzione (trattamento a ultravioletti C e asciugatura). Il ciclo di manutenzione impiega 30 minuti.

Spie di ricarica

Mentre il caricabatterie rileva l'apparecchio acustico, la spia **si accende fissa in giallo**:

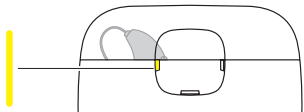

Una volta che il caricabatterie ha rilevato l'apparecchio acustico, inizierà la ricarica.

La spia **lampeggia in verde** per indicare che le batterie dell'apparecchio acustico sono a **meno del 40% della carica**:

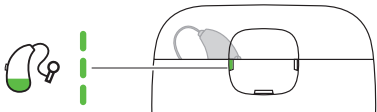

La spia **si accende in verde** per indicare che l'apparecchio acustico è a più del **40% di carica**:

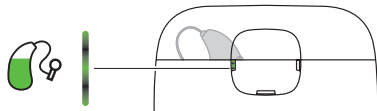

La spia si **accende fissa in verde** per indicare che l'apparecchio acustico è al **100% di carica**:

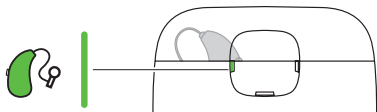

Dopo la ricarica

Non rimuovere gli apparecchi acustici dai vani di ricarica tirando il filo auricolare, in quanto ciò potrebbe danneggiare il collegamento tra il filo auricolare e l'apparecchio acustico. Collocare invece le dita intorno all'apparecchio acustico per rimuoverlo dal caricatore.

Quando si rimuove dal caricatore l'apparecchio acustico, questo si accende dopo alcuni secondi. Ricordarsi di spegnerlo se non si ha intenzione di usarlo subito.

Immediatamente dopo la ricarica, l'apparecchio acustico può restare temporaneamente caldo. Se questo causa fastidio, prima di indossare l'apparecchio acustico, attendere qualche minuto perché raggiunga la temperatura ambiente.

Manutenzione

La spia **lampeggia in bianco** per indicare che il ciclo di manutenzione è in corso (trattamento con ultravioletti C o asciugatura):

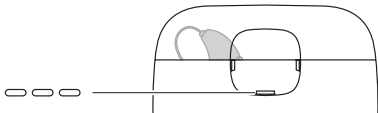

La spia **si accende in bianco fisso** per indicare che il ciclo di manutenzione è terminato:

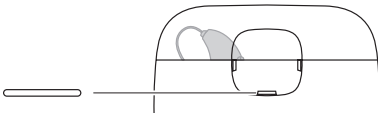

Se viene aperto il coperchio durante il ciclo di manutenzione, il ciclo viene messo in pausa ma la ricarica prosegue. Il ciclo di manutenzione ricomincerà quando viene chiuso il coperchio.

Pausa della manutenzione (luce **gialla** fissa)





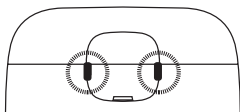

Panoramica delle spie

Ricarica



Spie	Stato
Giallo fisso 	Il caricatore sta rilevando l'apparecchio acustico.



Spie	Stato
Verde lampeggiante 	L'apparecchio acustico si sta ricaricando. Batteria scarica, inferiore al 40%.
Verde 	L'apparecchio acustico si sta ricaricando. Batteria superiore al 40%.
Verde fisso 	L'apparecchio acustico è completamente carico. Batteria al 100%.
Una spia rossa lampeggiante 	Si è verificato un errore durante la ricarica, che è stata arrestata. Consultare la sezione Risoluzione dei problemi.
Entrambe le spie lampeggiano in rosso 	Si è verificato un errore durante la ricarica, che è stata arrestata. Consultare la sezione Risoluzione dei problemi.

Spie

Giallo lampeggiante



Stato

La temperatura dell'apparecchio acustico è diventata troppo elevata durante la ricarica, che è stata sospesa.

Consultare la sezione Risoluzione dei problemi.

Manutenzione

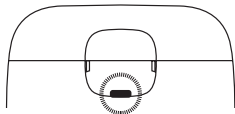

Spie

Bianco lampeggiante



Stato

Il ciclo di manutenzione è in corso (trattamento a ultravioletti C o asciugatura).

Bianco fisso



Il ciclo di manutenzione è completato.

Giallo fisso



Il ciclo di manutenzione è in pausa ma il ciclo di ricarica continua.

Spie

Rosso lampeggiante



Stato

Si è verificato un errore durante la manutenzione e il ciclo è stato arrestato.
Consultare la sezione Risoluzione dei problemi.

Giallo lampeggiante

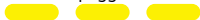

Il ciclo di manutenzione è sospeso per surriscaldamento (ventola ancora in funzione).
Consultare la sezione Risoluzione dei problemi.

Pulizia

Il caricabatterie in genere non richiede pulizia. Se necessario, pulire con cura il caricabatterie con un panno morbido asciutto.

Se si nota polvere nel vano di ricarica, soffiare delicatamente per pulirlo. Se questo non è sufficiente, pulire delicatamente il vano di ricarica con un batuffolo di cotone.

Per rimuovere il cerume dal caricabatterie, pulire con cura con un panno morbido leggermente imbevuto di detergente domestico non aggressivo.







Non utilizzare mai oggetti affilati/appuntiti per pulire il caricabatterie.

RISOLUZIONE DEI PROBLEMI

Queste pagine contengono consigli su cosa fare se il caricabatterie non funziona come previsto.

Spie	Possibile causa	Soluzione
Non si accendono	Il caricatore non è connesso.	Verificare che il cavo USB sia connesso correttamente al caricatore e a una porta USB compatibile con USB 2.0 oppure connettere il cavo USB alla presa a muro utilizzando l'adattatore di alimentazione incluso.
	L'apparecchio acustico non è inserito correttamente nel caricatore.	Collocare l'apparecchio acustico correttamente nel caricatore.

Spie	Possibile causa	Soluzione
Spia destra e/o sinistra in giallo lampeggiante 	La temperatura dell'ambiente circostante o dell'apparecchio acustico ha superato un limite critico e la ricarica è stata sospesa.	La ricarica continuerà quando la temperatura dell'ambiente circostante o dell'apparecchio acustico scenderà. Se questo avviene continuamente, trovare un luogo più fresco per ricaricare l'apparecchio acustico.
Spia destra o sinistra rossa lampeggiante 	Il caricatore non riconosce l'apparecchio acustico. L'apparecchio acustico ha riscontrato un errore critico.	Rimuovere l'apparecchio acustico incompatibile. Rimuovere l'apparecchio acustico, disconnettere l'alimentazione per 10 secondi e riprovare. Se il caricatore lampeggia ancora in rosso, contattare il proprio audioprotesista.

Spie	Possibile causa	Soluzione
La spia centrale lampeggia in rosso 	Il ciclo di manutenzione ha riscontrato un errore critico.	Rimuovere l'apparecchio acustico, disconnettere l'alimentazione per 10 secondi e riprovare. Se il caricatore lampeggia ancora in rosso, contattare il proprio audioprotesista.
Le spie destra e sinistra lampeggiano in rosso 	Il caricatore ha riscontrato un errore critico.	Rimuovere l'apparecchio acustico, disconnettere l'alimentazione per 10 secondi e riprovare. Se il caricatore lampeggia ancora in rosso, contattare il proprio audioprotesista.

INFORMAZIONI SULLE NORMATIVE

Usò previsto

Il caricabatterie modello Widex WPC101 è progettato per la ricarica dell'apparecchio acustico WIDEX MOMENT™MRR2D.

Direttive UE

Direttiva 2014/53/UE

Con la presente, WSAUD A/S dichiara che il presente WPC101 è conforme ai requisiti essenziali e alle altre disposizioni contenute nella Direttiva 2014/53/UE.

Il modello WPC101 contiene un trasmettitore radio che opera a: 6,78 MHz, 13,4 dB μ A/m a 3 m.

Copia della Dichiarazione di Conformità secondo 2014/53/UE è consultabile su

<https://global.widex.com/doc>



N26346

Informazioni relative allo smaltimento

Non smaltire apparecchi acustici, accessori di apparecchi acustici e cariche batterie insieme ai rifiuti domestici comuni.

Gli apparecchi acustici, gli accessori per apparecchi acustici e i caricabatterie devono essere smaltiti in siti destinati ad apparecchiature elettriche ed elettroniche o consegnati all'audioprotesista per uno smaltimento in condizioni di sicurezza.

Per la restituzione o la spedizione dei dispositivi, contattare l'audioprotesista.

SIMBOLI

Simboli utilizzati solitamente da WSAUD A/S per l'etichettatura dei suoi dispositivi medici (etichette, istruzioni per l'uso, ecc.)

Simbolo **Titolo/Descrizione:**



Produttore

Il prodotto è fabbricato dal produttore, il cui nome e indirizzo sono riportati accanto al simbolo. Se applicabile, può essere indicata anche la data di fabbricazione.



Codice catalogo

Codice del prodotto (articolo) in catalogo.



Consultare le istruzioni d'uso

Le istruzioni contengono importanti informazioni per la sicurezza (avvertenze/precauzioni) e devono essere lette prima di utilizzare il prodotto.



Avvertenza

I testi contrassegnati da questo simbolo di avvertenza devono essere letti prima di utilizzare il prodotto.



Contrassegno RAEE

"Non per rifiuti generici". Quando il prodotto è da eliminare va conferito a un punto di raccolta appositamente preposto per il riciclaggio e il recupero dei materiali, al fine di prevenire il rischio di danni per l'ambiente o la salute umana derivanti dalla presenza di sostanze pericolose.

Simbolo	Titolo/Descrizione:
	<p>Marchio CE Il prodotto è conforme ai requisiti stabiliti dalle direttive europee per il marchio CE.</p>
	<p>Marchio RCM Il prodotto è conforme ai requisiti normativi sulla sicurezza elettrica, di compatibilità elettromagnetica e sullo spettro radio per i prodotti forniti sui mercati australiano o neozelandese.</p>
	<p>Logo FCC Il prodotto è conforme alle pertinenti norme art. 47 CFR degli Stati Uniti. FCC – Federal Communications Commission.</p>
	<p>Dispositivo medico Indicazione che il dispositivo è un dispositivo medico.</p>

安全に関する重要な情報

充電器の使用を開始する前にこれらのページをよくお読みください。

 充電器およびその他の小さい部品は、お子様、ペット、精神に障がいのある方から離れた場所で使用、保管してください。

 充電器を 60° C (140° F) を超える温度、長時間の日光、裸火、または発火源にさらさないでください。

 充電する際には充電器を平らで安定した面に垂直に置き、充電器の周りには十分なスペースを確保してください。充電器を覆ったり、可燃性物質の近くに置いたりしないでください。この注意事項はパワーバンクをご使用の際にも適用されます。

 充電器は決してご自分で分解または修理しようとししないでください。不具合が生じた場合は販売店にご相談ください。

 補聴器には Widex 充電器のみを使用してください。WIDEX A/S が推奨しない充電器を使用した場合、装置に影響を与えたり、危険な状況が発生する可能性があります。

 充電器は直射日光が当たる場所に置かないでください。また水に浸けないでください。

 充電スロットには補聴器以外の物を挿入しないでください。

 充電器には Widex 電源アダプターとケーブルのみを使用してください。

充電器

ようこそ

本製品をお選びいただきありがとうございます。新しい WIDEX MOMENT™CHARGE n CLEAN 充電器は、WIDEX MOMENT™MRR2D の補聴器の検出、充電、メンテナンスを行います。

本装置の使用を開始する前に本書の指示をよくお読みください。

付記

お使いの充電器は、本書に示されている充電器とは外観が異なる場合があります。また当社は、必要と思われる変更を行う権利を有します。

充電器の概要

充電器は、各補聴器の充電ユニット、レシーバーのメンテナンスコンパートメント、ライトインジケータで構成されます。3つのインジケータライトは、補聴器の充電およびメンテナンスサイクルのステータスを示します。

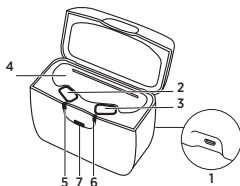

1. マイクロ USB ポート
2. 左耳の補聴器の充電スロット
3. 右耳の補聴器の充電スロット
4. レシーバーのメンテナンスコンパートメント
5. 左耳の補聴器の充電インジケータライト
6. 右耳の補聴器の充電インジケータライト
7. メンテナンスインジケータライト

使用、保管、輸送の条件

この充電器は屋内での使用を意図しています。高温などの過酷な条件による影響を受けやすくなっています。また、直射日光の当たる場所で使用、保管、または輸送しないでください。

充電器は以下の条件の範囲内で使用してください。

	最低	最高
温度	0° C (32° F)	35° C (95° F)
湿度	相対湿度 20%	相対湿度 75%

充電器は以下の条件の範囲内で保管および輸送してください。

	最低	最高
温度	-20° C (-4° F)	60° C (140° F)
湿度	相対湿度 5%	相対湿度 90%
気圧	750 hPa	1060 hPa

充電器の技術データシートと追加情報は <https://global.widex.com> でご覧いただけます。

充電器の使用

使用の準備

電源装置

最適な動作のため、充電器を主電源につなぎ、付属のケーブルと電源装置のみを使用してください。

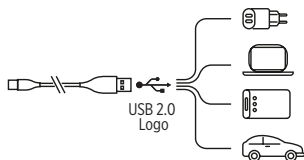

USB ポートが USB 2.0 対応ポートであることを確認してください。

ケーブルを充電器に接続します。

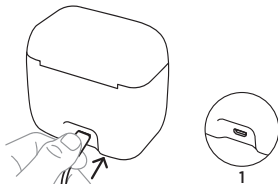

電源オン

充電器を電源に接続すると、インジケータライトが**白で5回点滅**してから消えます。

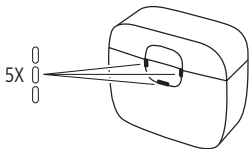

充電器はスタンバイモードになり、補聴器を充電する準備ができました。

補聴器の充電

補聴器をそれぞれの充電スロットにそっと置き、レシーバーをメンテナンスコンパートメントに入れます。補聴器は自動的にオフになります。**オフになったらカバーを閉じます。**

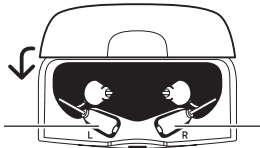

左耳の補聴器

右耳の補聴器

電源装置に接続すると、充電器は両方の補聴器を同時に充電することができます。補聴器の充電状態に応じて、それぞれの補聴器は個別に充電される場合もあります。片方の補聴器が完全に充電されている場合、充電器に入れても充電されませんが、充電されていないもう片方の補聴器は充電されます。

補聴器を完全に充電するには約**4時間**かかります。補聴器を30分間充電した場合、約4時間使用できます。

補聴器を充電中、メンテナンス（紫外線-C処理と乾燥）が実行されます。メンテナンスサイクルの所要時間は30分です。

充電インジケータ

充電器が補聴器を検出中、ライトインジケータは**黄色で点灯**します。

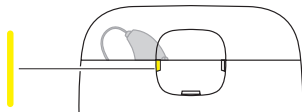

充電器が補聴器を検出すると充電が開始されます。

補聴器のバッテリー残量が少なく、**充電量が40%未満**の場合には、ライトインジケータは**緑で点滅**します。

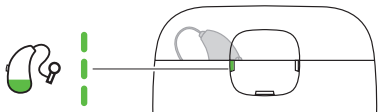

補聴器が**40%以上充電**されると、ライトインジケータは**緑で光り**ます。

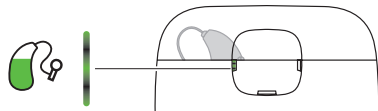

補聴器が**100%充電**されると、ライトインジケータは**緑で点灯**します。

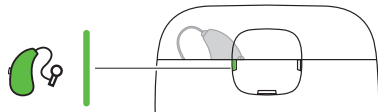

充電後

イヤークイヤーと補聴器の間の接続部が破損する可能性があります。そのため、イヤークイヤーを引っ張って充電スロットから補聴器を取り外さないでください。補聴器を充電器から取り出すときは補聴器を指でしっかり持ってください。

補聴器を充電器から取り出すと、数秒後に補聴器がオンになります。すぐに使用しない場合は補聴器の電源をオフにしてください。

充電直後は、補聴器が一時的に温かくなることがあります。これがご心配な場合は、補聴器を装着する前に補聴器が室温になるまで数分お待ちください。

メンテナンス

ライトインジケータが**白で点滅**している場合、メンテナンスサイクル（紫外線-C 処理または乾燥）が実行中であることを示します。

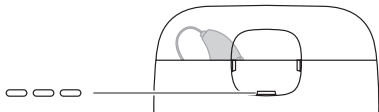

ライトインジケータが**白で点灯**すると、メンテナンスが終了したことを示します。

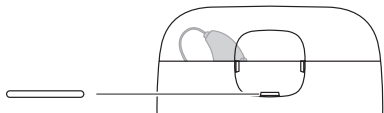

メンテナンスサイクル中にカバーを開けると、サイクルは一時停止しますが、充電は継続します。カバーを閉じると、メンテナンスサイクルは再開します。

メンテナンス一
時停止 (**黄色で
点灯**)



インジケータライトの概要

充電

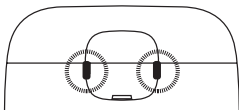

インジケータライト

ステータス

黄色で点灯



充電器が補聴器を検出中です。

緑で点滅



補聴器は充電中です。
低バッテリー、40%未満。

緑でぼんやりと点灯



補聴器は充電中です。
バッテリーは40%以上充電
されています。

緑で点灯



補聴器は完全に充電されて
います。
バッテリー 100%。

インジケータライト

いずれかのインジケータが
赤で点滅



ステータス

充電中にエラーが発生し、点滅している側の補聴器の充電が停止しています。トラブルシューティングを参照してください。

左右両方のインジケータが
赤で点滅



充電中にエラーが発生し、点滅している側の補聴器の充電が停止しています。トラブルシューティングを参照してください。

黄色で点滅

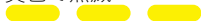

充電中に補聴器が高温になりすぎたため、充電が一時停止しています。トラブルシューティングを参照してください。

メンテナンス

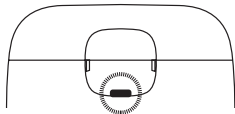

インジケータライト

ステータス

白で点滅



メンテナンスサイクルを実行中です(紫外線-C 処理または乾燥)。

白で点灯



メンテナンスサイクルが終了しました。

黄色で点灯

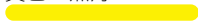

メンテナンスサイクルは一時停止しましたが、充電サイクルは実行中です。

赤で点滅



メンテナンス中にエラーが発生し、サイクルが停止しました。
トラブルシューティングを参照してください。

インジケータライト

黄色で点滅



ステータス

メンテナンスサイクルは過熱のため一時停止していません（ファンはまだ稼働しています）。
トラブルシューティングを参照してください。

お手入れ

充電器は通常お手入れの必要はありません。必要に応じて、柔らかい乾いた布で充電器を慎重に拭いてください。

充電スロットにほこりが付いている場合は軽く吹き飛ばしてください。これでほこりが取れない場合は、綿棒を使い、充電スロットを注意深く清掃してください。

充電器から耳垢を取り除くには、家庭用中性洗剤を少し含ませた柔らかい布で慎重に拭いてください。



充電器のお手入れには先の尖ったものを使用しないでください。

トラブルシューティング

以降のページには、充電器が正常に機能しない場合の対処方法が記載されています。

ライトインジケータ	考えられる原因	解決策
-----------	---------	-----

ライトが点灯しない	充電器が接続されていません。	USB ケーブルが充電器と USB 2.0 対応の USB ポートに正しく接続されていること、もしくは USB ケーブルが同梱の電源アダプターを使用してコンセントに差し込まれていることを確認してください。
-----------	----------------	--

補聴器が充電器に正しく置かれていません。	補聴器を充電器に正しく置いてください。
----------------------	---------------------

ライトインジケータ

考えられる原因

解決策

左右どちらか/
両方の
インジケータが
黄色で点滅



周囲温度または補聴器の温度が臨界値を超えているため、充電を一時停止しています。

周囲温度または補聴器の温度が下がると充電が再開されます。

これが繰り返り発生する場合は、温度の低い場所で補聴器を充電してください。

左右どちらかの
インジケータが
赤で点滅



充電器が補聴器を認識できません。

互換性のない補聴器を取り出してください。

補聴器に重大なエラーが発生しています。

補聴器を取り外し、電源を10秒間切断してからもう一度お試しください。
この操作を行っても、充電器が赤で点滅し続ける場合は

販売店にご相談ください。

ライトインジケータが考えられる原因

解決策

中央のインジケータが
赤で点滅点滅



メンテナンスサイクルで重大なエラーが発生しています。

補聴器を取り外し、電源を 10 秒間切断してからもう一度お試しください。
この操作を行っても、充電器が赤で点滅し続ける場合は 販売店にご相談ください

左右両方のインジケータが
赤で点滅 点滅



充電器に重大なエラーが発生しています。

補聴器を取り外し、電源を 10 秒間切断してからもう一度お試しください。
この操作を行っても、充電器が赤で点滅し続ける場合は 販売店にお問い合わせください。

規制情報

用途

Widex 充電器 WPC101 モデルは、WIDEX MOMENT™ MRR2D 補聴器を充電することを目的とした製品です。

EU 指令

指令 2014/53/EU

ここに、WSAUD A/S は、WPC101 が指令 2014/53/EU の基本要件および関連規定に準拠していることを宣言します。

WPC101 には、以下の条件で動作する無線送信機が搭載されています：6.78 MHz, 13.4 dBμA/m @ 3 m

2014/53/EU に従う適合宣言書のコピーを以下に掲載します。

<https://global.widex.com/doc>



N26346

廃棄に関する情報

補聴器、アクセサリ、充電器は通常の家ごみと一緒に捨てないでください。

補聴器、アクセサリ、充電器は、地区の定める電気・電化製品の処分方法に従って処分するか、購入元に安全な処分を依頼してください。

本装置の返品または発送については販売店にお問い合わせください。

記号

医療機器の表示（ラベルや取扱説明書など）で WSAUD A/S
によって共通して使用される記号

記号 タイトル/説明



製造元

製品は、名称および住所が記号の横に記載されたメーカーにより製造されています。該当する場合、製造日も記載される場合があります。



カタログ番号

製品のカタログ（品目）番号。



取扱説明書を参照

取扱説明書には安全に関する重要なお知らせ（警告/注意）が記載されていますので、製品のご使用前に必ずお読みください。



警告

警告記号を伴う事項は、製品のご使用前に必ずお読みください。











WEEE マーク

「一般廃棄物ではありません」製品の廃棄については、危険物質による環境や人の健康を害するリスクを防ぐため、指定されたリサイクル・回収場所に廃棄してください。

記号	タイトル/説明
	<p>CE マーク 製品は、CE マークに関する欧州指令によって定められた要件に適合しています。</p>
	<p>RCM マーク 製品は、オーストラリアとニュージーランド市場に供給される製品に対する電気安全性、EMC、無線スペクトル規制要件に準拠しています。</p>
	<p>FCC ロゴ 製品は、関連する USA47CFR 規則に準拠しています。 FCC - 米国連邦通信委員会</p>
	<p>医療機器 本機器が医療機器であることを示します。</p>

重要安全信息

在开始使用充电器之前，请仔细阅读以下内容。

-  确保充电器及其他小部件远离儿童、宠物和心智不健全人士。
-  切勿将充电器暴露在 60° C (140° F) 以上的高温下，避免长时间暴晒，远离明火或火源。
-  充电时，请将充电器直立放置在平坦、稳定的表面上，并在充电器周围留出足够的空间。切勿覆盖或在周围放置易燃物体。上述注意事项在使用行动电源时也同样适用。
-  切勿尝试自行打开或维修充电器。如遭遇故障，请联系您的听力保健专家。
-  仅使用 Widex 充电器为您的助听器充电。使用非 WIDEX A/S 推荐的充电器可能会损坏系统或导致危险。
-  切勿将充电器置于阳光直射的位置，也不要将其浸入水中。
-  切勿将除助听器之外的其他物体插入充电口。
-  仅使用 Widex 电源充电器和线缆与您的充电器搭配使用。

您的充电器

欢迎

感谢您选择本产品。您的新的 WIDEX MOMENT™CHARGE n CLEAN 充电器用于检测、充电和维护您的 WIDEX MOMENT™ MRR2D 助听器。

开始使用本设备前，请仔细阅读以下说明。

注意

您的充电器可能与本手册的图示不完全一致。我们保留对手册作出任何必要更改的权利。

充电器一览图

充电器由以下部件组成：各个助听器的充电单元、受话器的维护仓以及带有三个指示灯的指示器，指示灯用于显示助听器的充电状态以及维护周期的状态。

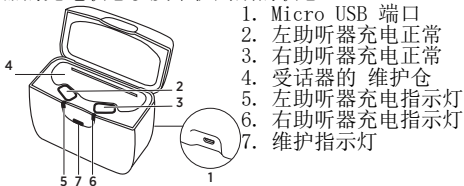

使用、存放和运输条件

您的充电器专为在室内使用而设计。它对高温等极端条件非常敏感，请勿在阳光直射下使用、存放或运输。

充电器的使用条件：

	最低	最高
温度	0° C (32° F)	35° C (95° F)
湿度	20% rH	75% rH

充电器的存放和运输条件：

	最低	最高
温度	-20° C (-4° F)	60° C (140° F)
湿度	5% rH	90% rH
气压	750 mbar	1060 mbar

您可在 <https://global.widex.com> 找到关于充电器的技术数据表和更多信息。

为充电器充电

准备使用

电源

为了达到最佳操作效果，请将充电器连接到主电源上，并仅使用附带的电缆和电源。

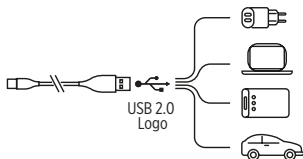

请确保 USB 端口兼容
USB 2.0。

将电缆连接到充电器：

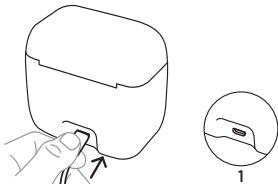

打开电源

充电器连接到电源时，指示灯白色闪烁 5 次，随后熄灭。

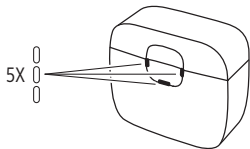

充电器现在处于待机模式，已经准备好为您的助听器充电。

为助听器充电

轻轻地将助听器置于各自的充电口中，并将受话器置入维护仓。助听器会自动关闭。然后关闭盖子。

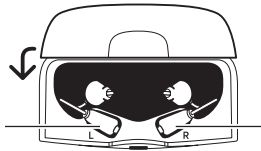

左耳助听器

右耳助听器

连接到电源后，充电器可以同时为两只助听器充电。根据助听器的状态，也可以单独为每只助听器充电。如果一只助听器已充满电并放在充电器中，则助听器不会充电，但如果另一只听器未充电，该助听器就会充电。

助听器充满电大约需要 **4 小时**。助听器充电半小时，大概可以使用 4 个小时。

为助听器充电的同时，同时还要进行维护（紫外线-C 处理和干燥）。维护周期为 30 分钟。

充电指示器

充电器检测助听器时，指示灯会呈**黄色常亮**：

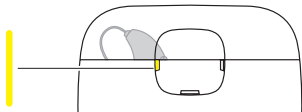

充电器检测到助听器后，将开始充电。

助听器电量低，剩余电量不到 40% 时，指示灯将呈绿色闪烁：

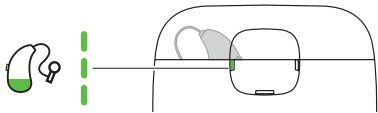

助听器剩余电量超过 40% 时，指示灯将呈荧光绿色：

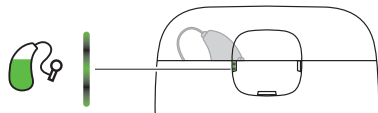

助听器充电 100% 后，指示灯将呈绿色常亮：

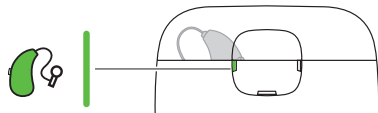

充电后

请勿通过拉动导声管从充电口中取出助听器，因为这可能会损坏导声管和助听器之间的连接。您应该用手指捏住助听器，将其取出充电器。

将助听器取出充电器后，助听器会在几秒钟后打开。如果您不打算立即使用，请记得关闭。

刚充完电时，助听器的温度可能有些高。如果您感到不适，请稍等几分钟，让助听器恢复到室温，然后再佩戴使用。

维护

指示灯**白色闪烁**，表示正在维护（紫外线-C 处理或干燥）：

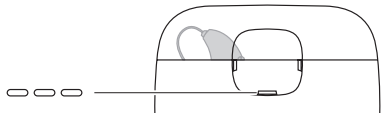

指示灯变为**白色常亮**，表示维护结束：

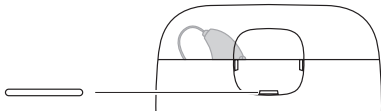

如果在维护期间打开盖子，则暂停维护，但仍会继续充电。
关闭盖子后，将重新开始维护。

暂停维护（黄灯常亮）

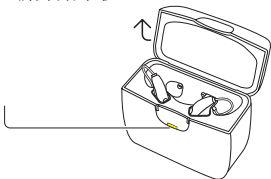

指示灯概述

充电

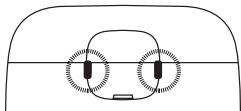

指示灯

黄色常亮







绿色闪烁



状态

充电器正在检测助听器。

助听器正在充电。
电量低，不到 40%。

指示灯	状态
荧光绿 	助听器正在充电。 电量高于 40%。
绿色常亮 	助听器已充满电。 电池 100%。
一个指示灯红色闪烁 	充电时出现错误，已停止充电。 请参见故障排除。
两个指示灯红色闪烁 	充电时出现错误，已停止充电。 请参见故障排除。
黄色闪烁 	充电时助听器温度过高，已暂停充电。 请参见故障排除。

维护

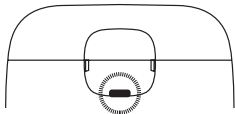

指示灯

状态

白色闪烁



正在维护（紫外线-C 处理或干燥）。

白色常亮



完成维护

黄色常亮



暂停维护，但仍继续充电。

红色闪烁



维护期间发生错误，并且已停止维护循环。
请参见故障排除。

黄色闪烁



由于过热（风扇仍在运行），已暂停维护。
请参见故障排除。

清洁

充电器通常不需要清洁。如有需要，请使用柔软的干布小心擦拭充电器。

如果您看到充电口中有任何灰尘，请轻吹干净。如果这还不够，请使用棉签小心清洁充电口。



要清洁充电器中的耳垢，请用软布蘸取少量的温和家用洗涤剂小心擦拭。





切勿使用锋利/尖端物体清洁充电器。

故障排除

以下页面介绍了针对充电器无法正常工作的建议。

指示灯	可能的原因	解决方案
指示灯不亮	充电器未连接。	请确保 USB 电缆已正确连接至充电器以及兼容 USB 2.0 的 USB 端口，或者使用随附的电源适配器将 USB 电缆插入墙壁插座。
	助听器未正确放入充电器内。	将助听器正确放入充电器中。
右和/或左 指示器黄色闪烁 	环境温度或助听器温度超过临界温度，已暂停充电。	在环境温度或助听器温度回落后，充电会继续进行。如果持续出现此问题，请换到温度较低的环境中为您的助听器充电。
右或左指示器红色闪烁 	充电器无法识别助听器。	取出不兼容的助听器。

指示灯	可能的原因	解决方案
	助听器出现严重错误。	取下助听器，断开电源 10 秒，然后重试。 如果充电器仍然呈红色闪烁，请联系您的听力保健专家。
中央指示器 红色闪烁 	维护周期出现严重错误。	取下助听器，断开电源 10 秒，然后重试。 如果充电器仍然呈红色闪烁，请联系您的听力保健专家。
右和左指示器 红色闪烁 	充电器出现严重错误。	取下助听器，断开电源 10 秒，然后重试。 如果充电器仍然呈红色闪烁，请联系您的听力保健专家。

法规信息

设计用途

Widex 充电器 WPC101 型号用于为 WIDEX MOMENT™ MRR2D 助听器充电。

欧盟指令

欧盟指令 2014/53/EU

WSAUD A/S 特此声明，WPC101 符合欧盟指令 2014/53/EU 的基本要求和相关规定。

WPC101 包含一个无线电发射器，工作参数为：6.78 MHz，13.4 dBμA/m @ 3 m。

根据指令 2014/53/EU 出具的符合标准声明发布在以下网站：

<https://global.widex.com/doc>



N26346

废弃物处置信息

请勿将助听器、助听器配件和充电器与普通的生活垃圾一起处置。



助听器、助听器配件和充电器应在专门处置废弃电气和电子设备的地方予以处置，或者交由您的听力保健专家进行安全处置。

如需退回或运送设备，请联系您的听力保健专家。

符号

WSAUD A/S 在医疗器械标签（标签/IFU 等）中常用的符号

符号	标题/说明
	制造商 本产品的制造商名称和地址说明列在符号旁。在适当的情况下，可能也会列出生产日期。
	目录编号 产品的目录（项目）编号。
	参阅使用说明 使用说明中包含重要的警示信息（警告/注意事项），在使用产品前请务必阅读。
	警告 在使用产品前，请务必阅读带有警告符号的文字。
	WEEE 标志 “非普通废弃物”。丢弃本产品时，必须将其送往指定的收集点回收利用，防止因有害物质而破坏环境或影响人类健康的风险。
	CE 标志 本产品符合欧盟 CE 标志指令中规定的要求。
	RCM 标志 本产品符合电气安全、EMC 和无线频谱监管要求，可在澳大利亚或新西兰市场销售。

符号	标题/说明
	FCC 标志 本产品符合相关 USA 47 CFR 规定。 FCC - 联邦通信委员会。
	医疗器械 指示该设备是医疗器械。

IMPORTANT SAFETY INFORMATION

Read these pages carefully before you start using your charger.



Keep the charger and other small parts away from children, pets, and mentally disabled people.



Never expose the charger to temperatures above 60° C (140° F), to prolonged sunlight, open flames or ignition sources.



Place the charger upright on a flat, stable surface when charging, with adequate space around the charger. Do not cover or place near flammable substances. This also applies when using a power bank.



Never try to open or repair the charger yourself. Contact your hearing care professional if you experience defects.



Use only a Widex charger with your hearing aids. Use of a charger not recommended by WIDEX A/S may compromise the system or result in dangerous situations.



Never leave the charger in direct sunlight and do not immerse it in water.



Never insert other objects than your hearing aids in the charging wells.



Use only a Widex power adapter and cable with your charger.

YOUR CHARGER

Welcome

Thank you for choosing this product. Your new WIDEX MOMENT™CHARGE n CLEAN charger is intended to detect, charge and maintain your WIDEX MOMENT™MRR2D hearing aid.

Read these instructions carefully before you start using this device.

NOTE

Your charger may not look exactly like the one illustrated in this booklet. We reserve the right to make any changes we consider necessary.

The charger at a glance

The charger consists of a charging unit for each hearing aid, a maintenance compartment for the receivers and a light indicator with three indicator lights that show the charging status of the hearing aids and the status of the maintenance cycle.

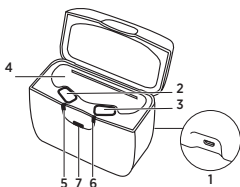

1. Micro USB port
2. Left hearing aid charging well
3. Right hearing aid charging well
4. Maintenance compartment for the receivers
5. Left hearing aid charging indicator light
6. Right hearing aid charging indicator light
7. Maintenance indicator light

Operating, storage and transport conditions

Your charger is designed for indoor use. It is sensitive to extreme conditions such as high temperatures, and it should not be operated, stored or transported in direct sunlight.

Operate the charger within the following conditions:

	Minimum	Maximum
Temperature	0° C (32° F)	35° C (95° F)
Humidity	20% rH	75% rH

Store and transport the charger within the following conditions:

	Minimum	Maximum
Temperature	-20° C (-4° F)	60° C (140° F)
Humidity	5% rH	90% rH
Atmospheric pressure	750 mbar	1060 mbar

You can find technical data sheets and additional information on your charger on <https://global.widex.com>.

OPERATING THE CHARGER

Getting ready for use

Power supply

For optimal operation, connect your charger to the mains and use only the included cable and power supply.

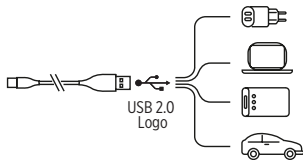

Please make sure that the USB port is USB 2.0 compatible.

Connect the cable to the charger:

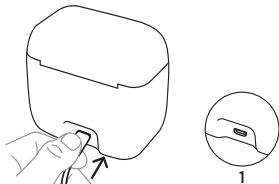

Power on

When the charger is connected to the power supply, the indicator lights **flash white 5 times** and then turn off:

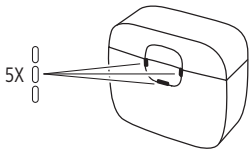

The charger is now in standby mode and ready to charge your hearing aid.

Charging the hearing aid

Gently place your hearing aids in their respective charging wells and the receivers in the maintenance compartment. The hearing aids turn off automatically. **Then close the lid.**

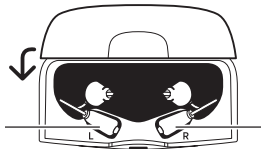

Left hearing aid

Right hearing aid

When connected to the power supply, the charger can charge two hearing aids simultaneously. Depending on the state of the hearing aids, each hearing aid can also be charged individually. If one hearing aid is fully charged and placed in the charger, it will not charge, but the other hearing aid, which is not fully charged, will be charged.

Charging your hearing aid fully will take approximately **4 hours**. If you charge your hearing aid for half an hour, you will have approximately 4 hours of use.

While charging the hearing aids, the maintenance (Ultraviolet-C treatment and drying) is carried out. The maintenance cycle takes 30 minutes.

Charging indicators

While the charger is detecting the hearing aid, the light indicator turns **solid yellow**:

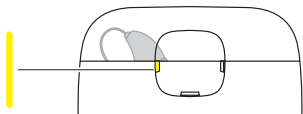

Once the charger has detected the hearing aid, the charging will begin.

The light indicator will **flash green** to indicate that the hearing aid is low on battery and less than **40% charged**:

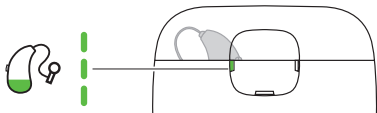

The light indicator will **glow green** to indicate that the hearing aid is more than **40% charged**:

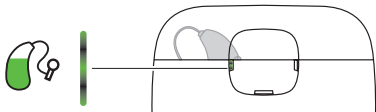

The light indicator will **turn solid green** to indicate that the hearing aid is **100% charged**:

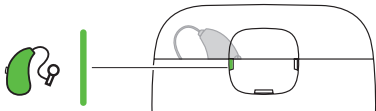

After charging

Avoid removing the hearing aids from the charging wells by pulling the earwire, as this could damage the connection between the earwire and the hearing aid. Instead, put your fingers around the hearing aid when removing it from the charger.

When you remove the hearing aid from the charger, the hearing aid turns on after a few seconds. Remember to turn it off if you are not going to use it right away.

Immediately after charging, the hearing aid may temporarily feel warm. If you are not comfortable with this, wait a few minutes for the hearing aid to reach room temperature, before putting the hearing aid on.

Maintenance

The light indicator will **flash white** to indicate that the maintenance cycle is in progress (Ultraviolet-C treatment or drying):

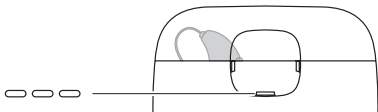

The light indicator turns **solid white** to indicate the end of the maintenance cycle:

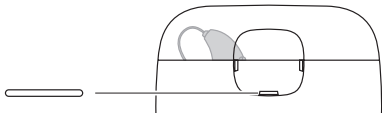

If the lid is opened during the maintenance cycle, the cycle is paused but the charging continues. The maintenance cycle will restart when the lid is closed.





Maintenance pause
(**solid yellow** light)

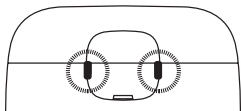

Overview of indicator lights

Charging



Indicator lights	Status
Solid yellow 	The charger is detecting the hearing aid.
Flashing green 	The hearing aid is charging. Low battery, less than 40%.
Glowing green 	The hearing aid is charging. Battery more than 40%.
Solid green 	The hearing aid is fully charged. Battery 100%.
One indicator flashing red 	An error occurred during charging and the charging has stopped. See Troubleshooting.

Indicator lights

Status

Both indicators flashing red



An error occurred during charging and the charging has stopped.
See Troubleshooting.

Flashing yellow



The temperature of the hearing aid has become too high during charging and charging is paused.
See Troubleshooting.

Maintenance

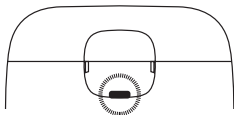

Indicator lights

Status

Flashing white





The maintenance cycle is in progress (Ultraviolet-C treatment or drying).

Solid white



The maintenance cycle is complete.

Indicator lights	Status
Solid yellow 	The maintenance cycle is paused but the charging cycle continues.
Flashing red 	An error occurred during the maintenance and the cycle has stopped. See Troubleshooting.
Flashing yellow 	The maintenance cycle is paused due to overheating (fan still running). See Troubleshooting.

Cleaning

The charger does not generally require cleaning. If necessary, carefully wipe off the charger with a soft dry cloth.

If you notice any dust in the charging well, gently blow it clean. If this is not enough, gently clean the charging well with a cotton bud.

To remove earwax from the charger, carefully wipe with a soft cloth with a bit of mild household detergent.





Never use sharp/pointy objects to clean the charger.

TROUBLESHOOTING

These pages contain advice on what to do if your charger does not work as expected.

Light indicators	Possible cause	Solution
No lights	The charger is not connected.	Make sure that the USB cable is correctly connected to the charger and a USB 2.0 compatible USB port or plug the USB cable into the wall socket using the included power adaptor.
	The hearing aid is not placed correctly in the charger.	Place the hearing aid correctly in the charger.
Right and/or left indicators flashing yellow 	The temperature of your surroundings or of the hearing aid exceeds a critical limit and the charging is paused.	The charging will continue when the temperature of your surroundings or the hearing aid has dropped. If this happens continually, find a cooler place to charge your hearing aid.

Light indicators	Possible cause	Solution
Right or left indicator flashing red 	The charger cannot recognise the hearing aid. The hearing aid has a critical error.	Remove the incompatible hearing aid. Remove the hearing aid, disconnect from the power for 10 seconds and then try again. If the charger is still flashing red, contact your hearing care professional.
Central indicator flashing red 	The maintenance cycle has a critical error.	Remove the hearing aid, disconnect from the power for 10 seconds and then try again. If the charger is still flashing red, contact your hearing care professional.
Right and left indicators flashing red 	The charger has a critical error.	Remove the hearing aid, disconnect from the power for 10 seconds and then try again. If the charger is still flashing red, contact your hearing care professional.

REGULATORY INFORMATION

Intended use

The Widex charger WPC101 model is to be used for charging the WIDEX MOMENT™MRR2D hearing aid.

EU directives

Directive 2014/53/EU

Hereby, WSAUD A/S declares that the WPC101 is in compliance with the essential requirements and other relevant provisions of Directive 2014/53/EU.

The WPC101 contains a radio transmitter operating at: 6.78 MHz, 13.4 dB μ A/m @ 3 m.

A copy of the Declaration of Conformity according to 2014/53/EU can be found at

<https://global.widex.com/doc>



N26346

Information regarding disposal

Do not dispose of hearing aids, hearing aid accessories and chargers with ordinary household waste.

Hearing aids, hearing aid accessories and chargers should be disposed of at sites intended for electrical waste and electronic equipment, or given to your hearing care professional for safe disposal.

For returning or shipping the devices, please contact your hearing care professional.

Wireless radio transmission





Electromagnetic emissions/immunity standards





The product complies with the following EMC/EMI standards:

Standard	Test type	Note
47 CFR Part 15, Subpart B	RF emissions	US FCC requirements for unintentional radiators
47 CFR Part 18	RF emissions	US FCC requirements for Industrial, Scientific and Medical Equipment
IEC 60601-1-2	General EMC including RF emissions, RF immunity, ESD	Medical Electrical Equipment, Electro-magnetic compatibility

SYMBOLS

Symbols commonly used by WSAUD A/S in medical device labelling (labels/IFU/etc.)

Symbol	Title/Description
	Manufacturer The product is produced by the manufacturer whose name and address are stated next to the symbol. If appropriate, the date of manufacture may also be stated.
	Catalogue number The product's catalogue (item) number.
	Consult instructions for use The user instructions contain important cautionary information (warnings/precautions) and must be read before using the product.
	Warning Text marked with a warning symbol must be read before using the product.
	WEEE mark "Not for general waste". When a product is to be discarded, it must be sent to a designated collection point for recycling and recovering to prevent the risk of harm to the environment or human health as a result of the presence of hazardous substances.

Symbol	Title/Description
	CE mark The product is in conformity with the requirements set out in European CE marking directives.
	RCM mark The product complies with electrical safety, EMC and radio spectrum regulatory requirements for products supplied to the Australian or New Zealand markets.
	FCC logo The product is compliant with relevant USA 47 CFR Rules. FCC – Federal Communications Commission.
	Medical device Indication that the device is a medical device.

FCC AND ISED STATEMENTS

Federal Communications Commission Statement



This device complies with part 15/part 18 of the FCC Rules. Operation is subject to the following two conditions:

- (1) This device may not cause harmful interference, and
- (2) this device must accept any interference received, including interference that may cause undesired operation.

NOTE:

This equipment has been tested and found to comply with the limits for a Class B digital device, pursuant to part 15 of the FCC Rules. These limits are designed to provide reasonable protection against harmful interference in a residential installation. This equipment generates, uses and can radiate radio frequency energy and, if not installed and used in accordance with the instructions, may cause harmful interference to radio communications. However, there is no guarantee that interference will not occur in a particular installation. If this equipment does cause harmful interference to radio or television reception, which can be determined by turning the equipment off and on, the user is encouraged to try to correct the interference by one or more of the following measures:

- Reorient or relocate the receiving antenna.
- Increase the separation between the equipment and receiver.

- Connect the equipment into an outlet on a circuit different from that to which the receiver is connected.
- Consult the dealer or an experienced radio/TV technician for help.

NOTE:

This equipment complies with FCC radiation exposure limits set forth for an uncontrolled environment. This transmitter must not be co-located or operating in conjunction with any other antenna or transmitter.

Changes or modifications to the equipment not expressly approved by WSAUD A/S could void the user's authority to operate the equipment.

ISED Statement / Déclaration d'ISED

CAN RSS-216/CNR-216

CAN ICES-1/NMB-1

This device contains licence-exempt transmitter(s)/receiver(s) that comply with Innovation, Science and Economic Development Canada's licence-exempt RSS(s). Operation is subject to the following two conditions:

- (1) This device may not cause interference.
- (2) This device must accept any interference, including interference that may cause undesired operation of the device.

L'émetteur/recepteur exempt de licence contenu dans le present appareil est conforme aux CNR d'Innovation, Sciences et Developpement economique Canada applicables aux appareils radio exempts de licence. L'exploitation est autorisee aux deux conditions suivantes:

(1) L'appareil ne doit pas produire de brouillage;

(2) L'appareil doit accepter tout brouillage radioelectrique subi, meme si le brouillage est susceptible d'en compromettre le fonctionnement.

ISED RADIATION EXPOSURE STATEMENT:

This equipment complies with ISED RF radiation exposure limits set forth for an uncontrolled environment. This transmitter must not be co-located or operating in conjunction with any other antenna or transmitter.

ISED EXPOSITION AUX RADIATIONS:

Cet equipement est conforme avec ISED les limites d'exposition aux rayonnements defini es pour un controle environnement. Cet emetteur ne doit pas etre co-localises ou fonctionner en conjonction avec une autre antenne ou emetteur.

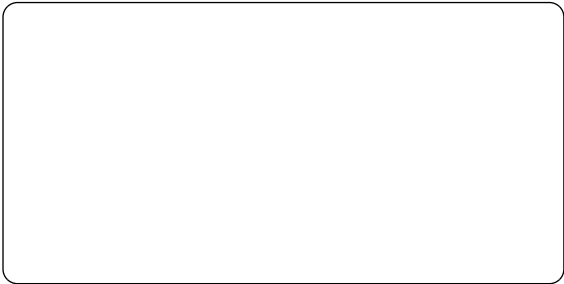

WSAUD A/S

Nymoellevej 6, DK-3540 Lyngby, Denmark
<https://global.widex.com>



Manual no.:
9 514 0595 094 01
Issue:
2021-01



9 514 0595 094 01

