



Quick Start

Pin Moisture Meter with Bluetooth®

Model MR55







Quick Start

INTRODUCTION

The latest versions of the detailed User Manual and Quick Start, with translations, are located on the <http://support.flir.com> web site (download tab). Please read these documents carefully before use.

QUICK STEPS

1. Ensure that two fresh 1.5V 'AA' batteries are installed in the meter's rear compartment.
2. Long press the Power button  to switch the meter ON. The meter automatically switches OFF after 20 minutes (APO).
3. Short press the  button to select a material group 1~11 (see Measurement Considerations section).
4. Remove the protective cap and firmly insert the test pins into the material under test.
5. Read the moisture level in % on the meter's large display digits.
6. Read the ambient temperature or relative humidity on the smaller digits. Long press the  button to select °F, °C, or RH display.
7. Long press the  button to switch the meter's backlight ON/OFF. Short press the  button to switch the meter's worklight ON/OFF.
8. To freeze/unfreeze a displayed measurement, short press the **HOLD** button.
9. To transmit a held reading, refer to the Bluetooth section below.
10. Replace the protective cap after each and use caution when the sharp pins are exposed.
11. Verify calibration using the test points in the protective cap as described in the User Manual.

METER DESCRIPTION

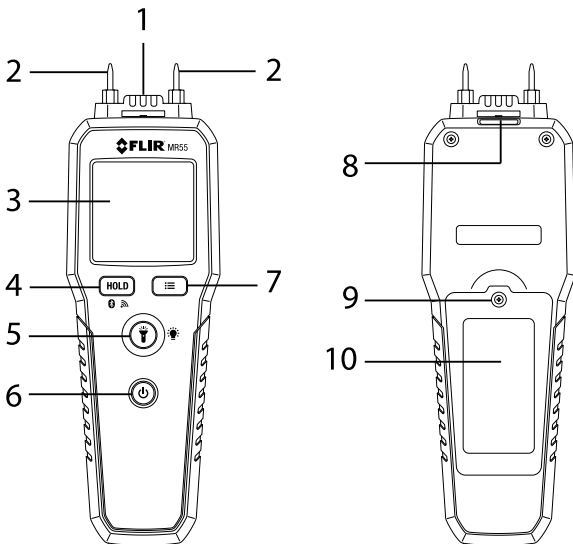





1. Temperature / RH sensors
2. Electrode pins
3. Backlit LCD
4. Data Hold / Transmit button
5. Worklight / Backlight button
6. Power ON-OFF button
7. Material group select and Temperature/RH button
8. Worklight
9. Battery compartment lock
10. Battery compartment

Note: Protective pin cap not pictured.

Note: QR code on back of meter provides website link to material group information for wood and building materials.

FUNCTION BUTTONS

| | |
|---|---|
|  | Long press to power the meter ON/OFF |
| HOLD | Short press to freeze/unfreeze displayed readings (readings must be held before they can be transmitted via Bluetooth) |
|  | Long press to transmit held reading to remotely connected device using Bluetooth |
|  | Short press to switch worklight ON/OFF |
|  | Long press to switch display backlight ON/OFF |
|  | Short press to select a material group number (1~11) Long press to select ambient temperature or relative humidity display on lower left of screen |

DISPLAY DESCRIPTION

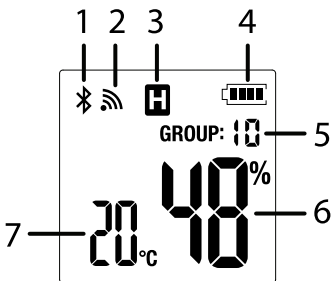

1. Bluetooth icon appears when meter is paired with remote device
2. Transmission icon appears for 3 seconds while transmitting
3. Data Hold freezes displayed reading
4. Battery status
5. Material Group Number. Refer to User Manual for reference tables
6. Moisture reading
7. Ambient temperature or Relative Humidity display

MEASUREMENT CONSIDERATIONS

- Moisture Measurement ranges:



| | |
|-------------------------------|----------|
| Wood | 7 to 99% |
| Building materials (Group 10) | 1 to 99% |
| Building materials (Group 11) | 1 to 35% |

- Moisture readings are automatically temperature compensated
- When testing wood, always insert the pins perpendicular to the wood's fiber structure
- Take a number of readings in several locations for the best representation of the moisture present
- Material Groups 1~8 are for timber; Group 9 is for plywood and oriented strand board (OSB); Group 10 is for brick, cement screed, and concrete; Group 11 is for cement mortar, anhydrite screed, lime mortar, and plaster. Download the User Manual at <http://support.flir.com> for complete details.

BLUETOOTH COMMUNICATION

When connected to a remote device running the FLIR Tools™ mobile app, the MR55 (using the METERLiNK® protocol) can send readings for display on the remote device. When connected to a compatible FLIR camera that supports BLE (Bluetooth Low Energy), the MR55 can send meter readings for display on the camera. Download the FLIR Tools mobile app from the Google Play™ Store, the Apple App store, or from here:

<https://www.flir.com/products/flir-tools-app/>

- When successful communication between the meter and a remote device or FLIR camera is established, the Bluetooth icon  appears on the MR55 display.
- Refer to the FLIR Tools help utility (in the mobile app) for detailed information regarding FLIR Tools.
- To transmit a displayed reading, first short press the MR55 **HOLD** button to freeze the reading (the 'H' icon appears) and then long press the  button to transmit.
- The transmission icon  appears for 3 seconds during the transmission of the moisture reading, material group number, and temperature/humidity readings. Date/time stamp can be taken from the remote device at the time of transfer.
- To unfreeze the displayed reading, short press the **HOLD** button again (the 'H' icon will switch OFF).

Customer Support

| | |
|--|---|
| Customer Support Telephone List: | https://support.flir.com/contact |
| Repair, Calibration, and Technical Support | https://support.flir.com |

Three-Year Limited Warranty

This product is protected by FLIR's 3-Year Limited Warranty. Visit www.flir.com/testwarranty to read the 3-Year Limited Warranty document.



Quick Start

Website

<http://www.flir.com>

Customer support

<http://support.flir.com>

Copyright

© 2021, FLIR Systems, Inc. All rights reserved worldwide.

Disclaimer

Specifications subject to change without further notice. Models and accessories subject to regional market considerations. License procedures may apply. Products described herein may be subject to US Export Regulations. Please refer to exportquestions@flir.com with any questions.

Publ. No.: NAS100098
Release: AB
Commit: 80702
Head: 80849
Language: en-US
Modified: 2021-11-02
Formatted: 2021-11-11