

VHF/UHF  
 ULTRA-COMPACT DUAL-BAND TRANSCEIVER  
 WITH WIDE BAND COVERAGE

# VX-3R

## Technical Supplement

©2007 VERTEX STANDARD CO., LTD. EH028M90A

**VERTEX STANDARD CO., LTD.**  
 4-8-8 Nakameguro, Meguro-Ku, Tokyo 153-8644, Japan

**VERTEX STANDARD**  
 US Headquarters  
 10900 Walker Street, Cypress, CA 90630, U.S.A.

**YAESU EUROPE B.V.**  
 P.O. Box 75525, 1118 ZN Schiphol, The Netherlands

**YAESU UK LTD.**  
 Unit 12, Sun Valley Business Park, Winnall Close  
 Winchester, Hampshire, SO23 0LB, U.K.

**VERTEX STANDARD HK LTD.**  
 Unit 5, 20/F., Seaview Centre, 139-141 Hoi Bun Road,  
 Kwun Tong, Kowloon, Hong Kong

**VERTEX STANDARD (AUSTRALIA) PTY., LTD.**  
 Normanby Business Park, Unit 14/45 Normanby Road  
 Notting Hill 3168, Victoria, Australia

**Downloaded by  
 RadioAmateur.EU**



### Introduction

This manual provides the technical information necessary for servicing the VX-3R Ultra-Compact Dual-Band Transceiver.

Servicing this equipment requires expertise in handling surface-mount chip components. Attempts by non-qualified persons to service this equipment may result in permanent damage not covered by the warranty, and may be illegal in some countries.

Two PCB layout diagrams provided for each double-sided board in this transceiver. Each side of the board is referred to by the type of the majority of components installed on that side ("Side A" or "Side B"). In most cases one side has only chip components, and the other has either a mixture of both chip and leaded components (trimmers, coils, electrolytic capacitors, ICs, etc.), or leaded components only.

While we believe the information in this manual to be correct, VERTEX STANDARD assumes no liability for damage that may occur as a result of typographical or other errors that may be present. Your cooperation in pointing out any inconsistencies in the technical information would be appreciated.

### Important Note

This transceiver was assembled using Pb (lead) free solder, based on the RoHS specification. Only lead-free solder (Alloy Composition: Sn-3.0Ag-0.5Cu) should be used for repairs performed on this apparatus. The solder stated above utilizes the alloy composition required for compliance with the lead-free specification, and any solder with the above alloy composition may be used.

### Contents

<b>Specification .....</b>	<b>2</b>
<b>Exploded View &amp; Miscellaneous Parts.....</b>	<b>4</b>
<b>Block Diagram .....</b>	<b>5</b>
<b>Circuit Description .....</b>	<b>7</b>
<b>Alignment.....</b>	<b>9</b>
<b>Board Unit (Schematics, Layouts &amp; Parts)</b>	
MAIN Unit .....	15
Filter Unit .....	31
SW Unit.....	35
VCO Unit .....	39

# Specifications

## General

<b>Frequency Ranges:</b> (USA Version)	RX 0.5-1.8 MHz (AM Broadcast) 1.8-30 MHz (SW Band) 30-76 MHz (50 MHz HAM) 76-108 MHz (FM) 108-137 MHz (Air Band) 137-174 MHz (144 MHz HAM) 174-222 MHz (VHF TV) 222-420 MHz (ACT1) 420-470 MHz (430 MHz HAM) 470-800(729) MHz (UHF TV) (757-774) MHz (UHF TV) 800-999 MHz (GEN2; USA Cellular Blocked)
	TX 144-146(148) MHz 430-440(450) MHz
<b>Channel Steps:</b>	5/9/8.33/10/12.5/15/20/25/50/100 kHz
<b>Frequency Stability:</b>	±5 ppm (-10 °C to +60 °C)
<b>Repeater Shift:</b>	±600 kHz (144 MHz) ±1.6/5.0/7.6 MHz (430 MHz)
<b>Emission Type:</b>	F2D, F3E, F2A
<b>Antenna Impedance:</b>	50 W
<b>Supply Voltage:</b>	Nominal: 3.7 V DC, Negative Ground Operating: 3.7 ~ 7.0 V, Negative Ground (EXT DC Jack) 5.0 ~ 7.0 V, Negative Ground (EXT DC Jack w/Charging)
<b>Current Consumption:</b>	120 mA (Receive) 60 mA (Standby, Saver Off) 30 mA (Standby, Saver On, Save Ratio 1:2) 50 mA (Radio Band Receive) 100 µA (Auto Power Off) 1.3 A (1.5 W Tx, 144 MHz) 3.7 V DC 1.6 A (3 W Tx, 144 MHz) 6 V DC 1.2 A (1 W Tx, 430 MHz) 3.7 V DC 1.8 A (2 W Tx, 430 MHz) 6 V DC
<b>Operating Temperature:</b>	-20 °C to +60 °C
<b>Case Size (W x H x D):</b>	1.9" x 3.2" x 0.9" (47 x 81 x 23 mm) (W/O knob & antenna)
<b>Weight:</b>	4.6 oz (130 g) With FNB-82LI & antenna

## Transmitter

<b>RF Power Output:</b>	1.5 W (@ 4.5 V AA x 3 or 3.7 V FNB-82LI 144 MHz) 3 W (@ 6 V or EXT DC 144 MHz) 1 W (@4.5 V AA x 3 or 3.7 V FNB-82LI 430 MHz) 2 W (@ 6 V or EXT DC 430 MHz) Low 0.1 W (@ 4.5 V AA x 3 or 3.7 V FNB-82LI) Low 0.3 W (@ 6 V or EXT DC)
<b>Modulation Type:</b>	Variable Reactance F2D, F3E, F2A
<b>Maximum Deviation:</b>	±5 kHz (F2D, F3E)
<b>Spurious Emission:</b>	At least 60 dB below (HIGH) At least 50 dB below (LOW or less than 1 W)
<b>Microphone Impedance:</b>	2 kΩ

Downloaded by  
RadioAmateur.EU

## Receiver

<b>Circuit Type:</b>	AM, NFM: Double-Conversion Superheterodyne WFM: Triple-Conversion Superheterodyne AM Radio/FM Radio: Single-Conversion Superheterodyne
<b>Intermediate Frequencies:</b>	1st: 47.25 MHz (AM, NFM) 1st: 45.8 MHz (WFM) 1st: 130 kHz (AM Radio/FM Radio) 2nd: 450 kHz (AM, NFM) 2nd: 10.7 MHz (WFM) 3rd: 1 MHz (WFM)
<b>Sensitivity:</b>	3 $\mu$ V for 10 dB SN (0.5-1.8 MHz, AM Radio) 3 $\mu$ V for 10 dB SN (1.8-30 MHz, AM) 0.35 $\mu$ V TYP for 12 dB SINAD (30-54 MHz, NFM) 1 $\mu$ V TYP for 12 dB SINAD (54-76 MHz, NFM) 3 $\mu$ V TYP for 12 dB SINAD (76-108 MHz, FM Radio) 1.5 $\mu$ V TYP for 10 dB SN (108-137 MHz, AM) 0.2 $\mu$ V for 12 dB SINAD (137-140 MHz, NFM) 0.16 $\mu$ V for 12 dB SINAD (140-150 MHz, NFM) 0.2 $\mu$ V for 12 dB SINAD (150-174 MHz, NFM) 1 $\mu$ V TYP for 12 dB SINAD (174-225 MHz, NFM) 0.5 $\mu$ V for 12 dB SINAD (300-350 MHz, NFM) 0.2 $\mu$ V for 12 dB SINAD (350-400 MHz, NFM) 0.18 $\mu$ V for 12 dB SINAD (400-470 MHz, NFM) 1.5 $\mu$ V for 12 dB SINAD (470-540 MHz, WFM) 3 $\mu$ V TYP for 12 dB SINAD (540-800 MHz, WFM) 1.5 $\mu$ V TYP for 12 dB SINAD (800-999 MHz, NFM) USA Version Cellular Blocked
<b>Selectivity:</b>	NFM, AM: 12 kHz/35 kHz (-6 dB /-60 dB) WFM : 200 kHz / 300 kHz (-6 dB/-20 dB)
<b>AF Output:</b>	50 mW @ 8 $\Omega$ for 10 % THD (@ 3.7 V) 100 mW @8 W for 10 % THD (@ 6 V)

*Specifications are subject to change without notice, and are guaranteed within the 144 and 430 MHz amateur bands only. Frequency ranges will vary according to transceiver version; check with your dealer.*

# Exploded View & Miscellaneous Parts

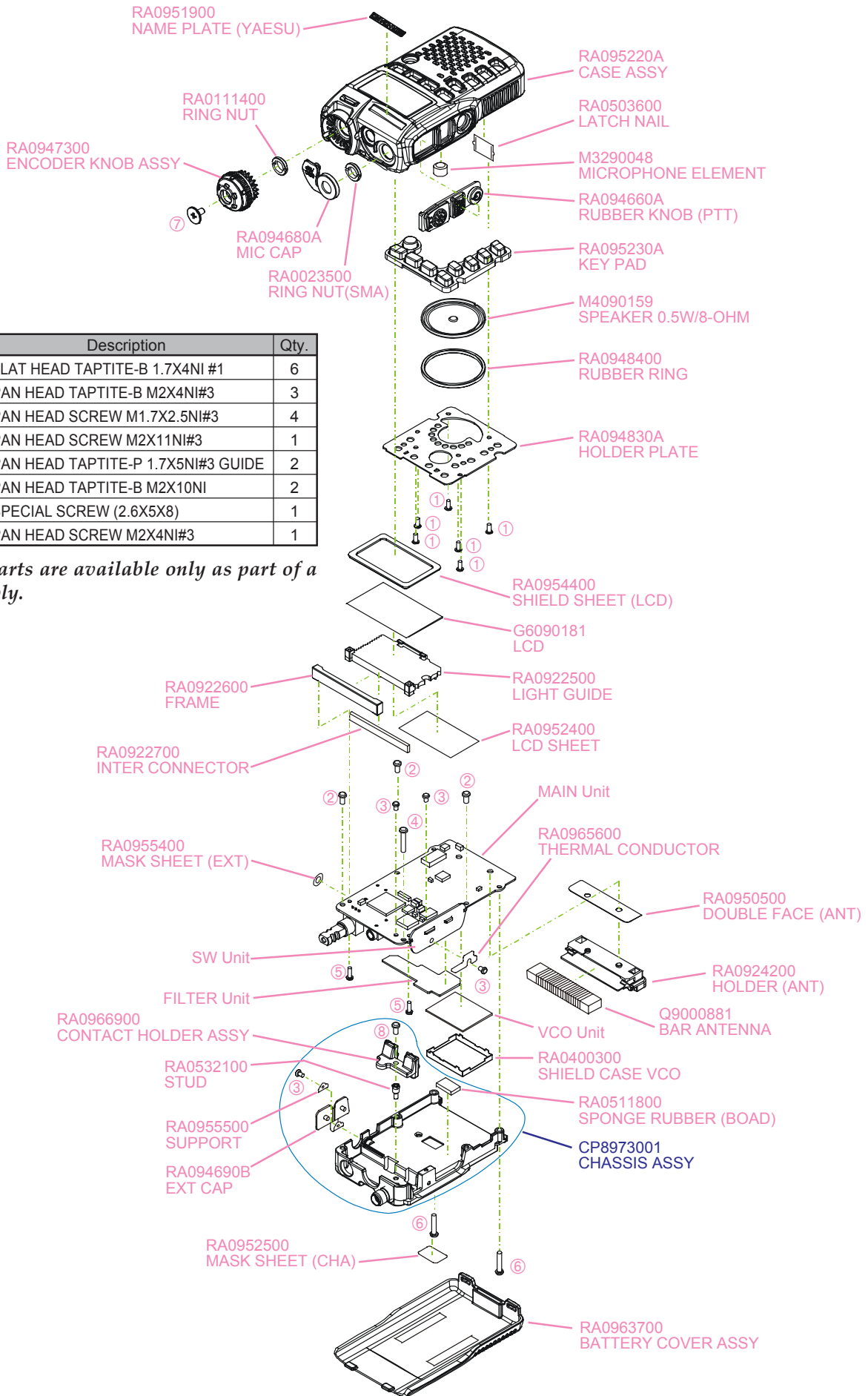

No.	VXSTD P/N	Description	Qty.
①	U9900220	FLAT HEAD TAPTITE-B 1.7X4NI #1	6
②	U9900068	PAN HEAD TAPTITE-B M2X4NI#3	3
③	U07125302	PAN HEAD SCREW M1.7X2.5NI#3	4
④	U9900156	PAN HEAD SCREW M2X11NI#3	1
⑤	U9900044	PAN HEAD TAPTITE-P 1.7X5NI#3 GUIDE	2
⑥	U44110002	PAN HEAD TAPTITE-B M2X10NI	2
⑦	RA0918600	SPECIAL SCREW (2.6X5X8)	1
⑧	U07240302	PAN HEAD SCREW M2X4NI#3	1

Non-designated parts are available only as part of a designated assembly.

# Block Diagram

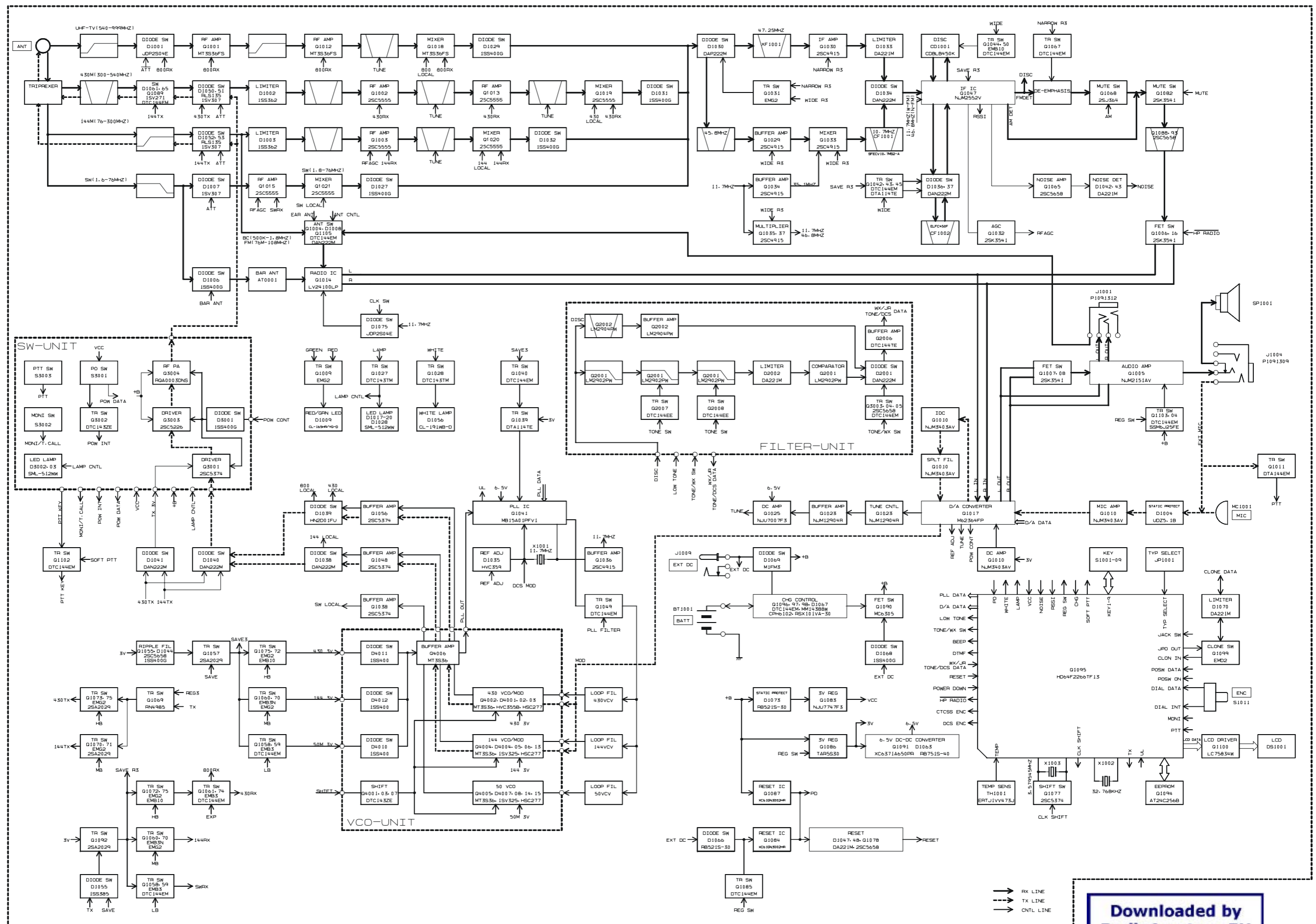

*Note*

# Circuit Description

The VX-3R consists of a MAIN-UNIT, a FILTER-UNIT, a SW-UNIT, and a VCO-UNIT. The MAIN-UNIT contains the receiver front end, PLL IC, power and switching circuits, the CPU, audio ICs, and the power circuitry for the LCD, the IF, and audio ICs and the VCO-UNIT for transmit and receive local signal oscillation.

## Receiver Signal Flow

The VX-3R includes four receiver front ends, each optimized for a particular frequency range and mode combination.

### (1) Triplexer

Received 145 MHz signals, after passing through a low-pass filter to the VHF T/R switch circuit composed of diode switch **D1052 (RLS135)** and **D1053 (1SV307)**.

Received 430 MHz signals, after passing through a low-pass filter to the UHF T/R switch circuit composed of diode switch **D1050 (RLS135)** and **D1051 (1SV307)**.

### (2) VHF Bands Reception

Received signals between 140 and 150 MHz pass through the Triplexer circuit, low-pass filter/high-pass filter circuit, VHF T/R switch circuit and protector diode **D1003 (1SS362)** before additional filtering by a band-pass filter prior to application to RF amplifier **Q1003 (2SC5555)**. The amplified RF signal is pass through the band-pass filter to first mixer **Q1020 (2SC5555)**. Meanwhile, VHF output from the VCO-UNIT is amplified by **Q1048 (2SC5374)** and applied through diode T/R switch **D1038 (DAM222M)** to mixer **Q1020 (2SC5555)** as the first local signal.

The 47.25 MHz intermediate frequency product of the mixer is delivered to the IF circuit.

The TUNE voltage from the CPU is amplified by DC amplifier **Q1025 (NJU7007F3)** and applied to varactors **D1011 (1SV325)**, **D1012 (1SV325)**, **D1013 (HVC369B)**, **D1014 (1SV325)**, **D1015 (1SV325)**, **D1016 (HVC369B)**, **D1025 (1SV325)**, and **D1026 (1SV325)** in the variable frequency band-pass filters. By changing the electrostatic capacitance of the varactors, optimum filter characteristics are provided for each specific operating frequency.

### (3) UHF Bands Reception

Received signals between 430 and 450 MHz pass through the Triplexer circuit, low-pass filter/high-pass filter circuit, UHF T/R switch circuit and protector diode **D1002 (1SS326)** before additional filtering by a band-pass filter prior to application to RF amplifier **Q1002 (2SC5555)**. The amplified RF signal is pass through the band-pass filter, RF amplifier **Q1013 (2SC5555)** and band-pass filter to first mixer **Q1019 (2SC5555)**. Meanwhile, UHF output from the VCO-UNIT is amplified by **Q1056 (2SC5374)** and applied through diode T/R switch **D1039 (DAM222M)** to mixer **Q1019 (2SC5555)** as the first local signal.

The 47.25 MHz intermediate frequency product of the mixer is delivered to the IF circuit.

The TUNE voltage from the CPU is amplified by DC amplifier **Q1025 (NJU7007F3)** and applied to varactors **D1005**, **D1010**, **D1023**, and **D1024** (all **HVC358B**) in the variable frequency band-pass filters. By changing the electrostatic capacitance of the varactors, optimum filter characteristics are provided for each specific operating frequency.

### (4) 47.25-MHz First Intermediate Frequency

The 47.25 MHz first intermediate frequency from first mixers is delivered from the first mixer to IF circuit. On the MAIN-UNIT, the IF for AM and FM-narrow signals is passed through diode switch **D1030 (DAP222M)** and 47.25 MHz monolithic crystal filter (MCF) XF1001 to narrow IF amplifier **Q1030 (2SC4915)** for input to IF IC **Q1047 (NJM2552V)** after amplitude limiting by **D1033 (DA221M)**.

Meanwhile, a portion of the output of 11.7 MHz crystal X1001 is multiplied fourfold by **Q1035** and **Q1037** (both **2SC4915**) to provide the 46.8 MHz second local signal, applied to the Narrow IF IC. Within the IC, this signal is mixed with the 47.25 MHz first intermediate frequency signal to produce the 450 kHz second intermediate frequency.

This second IF is filtered by ceramic filter CF1002 and amplified by the limiting amplifier within the Narrow IF IC before quadrature detection by ceramic discriminator CD1001.

Demodulated audio is output from pin 11 of the Narrow IF IC through narrow mute analog switch **Q1068 (2SJ364)**.

The resulting audio is amplified by AF amplifier **Q1005 (NJM2151AV)**, and output through MIC/EAR jack J1004 to internal speaker SP1001 or an external earphone.

## Transmitter Signal Flow

### (1) 145 MHz Band Transmit/Receive Switching

Closing PTT switch S3003 on the SW-UNIT pulls the base of **Q1011 (DTA144EM)** low, causing the collector to go high. This signal is input to pin 44 (PTT) of CPU **Q1095 (HD64F2266TF13V)**, allowing the CPU to recognize that the PTT switch has been pushed. When the CPU detects closure of the PTT switch, pin 70 (TX/RX) goes high. This control signal switches **Q1069 (RN4985)** to produce the TX control signal that activates **Q1071 (2SA2029)**. At the same time, PLL division data is input to PLL IC **Q1041 (MB15A01PFV1)** from the CPU, to disable the receiver power saver. Also, switching **Q1070 (EMG2)** to disable the receiver circuits. Then causing the red side of BUSY/TX lamp **D1009 (CL-165HR/YG)** to light.

# Circuit Description

## (2) Modulation

Voice signal input from either built-in microphone MC1001 on MAIN-UNIT or external jack J1004 on the MAIN-UNIT is pre-emphasized by C1056 and R1033, and processed by microphone amplifier **Q1010 (NJM3403AV)**, IDC (instantaneous deviation control) circuit **Q1010 (NJM3403AV)** to prevent over-modulation, and active low-pass filter **Q1010 (NJM3403AV)**.

During CTCSS operation, the voice signal is mixed with the TONE ENC subaudible tone signal from pin 43 of the CPU and delivered to the VCO. During DTMF operation, the DTMF tones from pin 55 of the CPU are input to the IDC stage.

## (3) 145 MHz Band Transmission

Modulating audio passes through deviation setting D/A converter **Q1017 (M62364FP)** to VHF MOD of the VCO-UNIT mounted on the MAIN-UNIT. This signal is applied to varactor **D4005 (HSC277TRF)** in the tank circuit of VHF VCO **Q4004 (MT3S36FS)**, which oscillates at the desired VHF transmitting frequency. The modulated VCO signal is buffered by amplifier **Q4006 (MT3S36FS)** and **Q1048 (2SC5374)** and delivered through VHF T/R diode switch **D1038** to the MAIN-UNIT. The modulated low-level VHF transmit signal from the VCO is passed through diode switch **D1040 (DAN222M)** to amplifier **Q3001 (2SC5374)**. The modulated VHF transmit signal from the VCO is amplified by **Q3001 (2SC5374)** and RF power amplifier **Q3003 (2SC5226)** up to 0.3 or 3 W (depending on the power source). The RF output passes through TX diode switch **D1052 (RLS135)**. RF output is passed by T/R switch and low-pass filter to suppress harmonics and spurious products before output to the antenna at the antenna terminal.

## (4) 435 MHz Band Transmission

Modulating audio passes through deviation setting D/A converter **Q1017 (M62364FP)** to UHF MOD of the VCO-UNIT mounted on the MAIN-UNIT. This signal is applied to varactor **D4002 (HSC277TRF)** in the tank circuit of UHF VCO **Q4002 (MT3S36FS)**, which oscillates at the desired UHF transmitting frequency. The modulated VCO signal is buffered by amplifier **Q4006 (MT3S36FS)** and **Q1056 (2SC5374)** and delivered through UHF T/R diode switch **D1039 (DAN222M)** to the MAIN-UNIT. The modulated low-level UHF transmit signal from the VCO is passed through diode switch **D1040 (DAN222M)** to amplifier **Q3004 (RQA0003DNS)**. The modulated UHF transmit signal from the VCO is amplified by **Q3001 (2SC5374)** and RF power amplifier **Q3003 (2SC5226)** up to 0.3 or 2 W (depending on the power source). The RF output passes through TX diode switch **D1050 (RLS135)**. RF output is passed by T/R switch and low-pass filter to suppress harmonics and spurious products before output to the antenna at the antenna terminal.

## PLL Frequency Synthesizer

PLL IC **Q1041 (MB15A01PFV1)** on the MAIN-UNIT consists of a data shift register, reference frequency divider, phase comparator, charge pump, intermittent operation circuit, and band selector switch. Serial PLL data from the CPU is converted into parallel data by the shift register in the PLL IC and is latched into the comparative frequency divider and reference frequency divider to set a frequency dividing ratio for each. An 11.7 MHz reference signal produced by X1001 is input to REF pin 1 of the PLL IC. The internal reference frequency divider divides the 11.7 MHz reference by 2,050 (or 1,640) to obtain a reference frequency of 5 kHz (or 6.25 kHz), which is applied to the phase comparator. Meanwhile, a sample of the output of VHF VCO **Q4004** or UHF VCO **Q4002** on the VCO-UNIT, buffered by **Q4006**, is input to the PLL IC, where it is frequency-divided by the internal comparative frequency divider to produce a comparative frequency also applied to the phase comparator. The phase comparator compares the phase between the reference frequency and comparative frequency to output a pulse corresponding to the phase difference between them. This pulse is input to the charge pump, and the output from the charge pump passes through a loop filter composed of R1280, R1281, C1185, R1169 and either R1171, C1187, R1174 and C1190 for VHF, or R1170, C1186, R1173 and C1189 for UHF, which convert the pulse into a corresponding smoothed varactor control voltage (VCV). The VCV is applied to varactor **D4004** and **D4013** (both **1SV325**) in the VHF VCO tank circuit, or to varactor **D4001 (HVC355B)** in the UHF VCO tank circuit, to eliminate phase difference between the reference frequency and comparative frequency, and so locking the VCO oscillation frequency to the reference crystal. The VCO frequency is determined by the frequency-dividing ratio sent from the CPU to the PLL IC. During receiver power save operation, the PLL circuit operates intermittently to reduce current consumption, for which the intermittent operation control circuit reduces the lock-up time.



## Introduction

The VX-3R is carefully aligned at the factory for the specified performance across the amateur band. Realignment should therefore not be necessary except in the event of a component failure. Only an authorized VERTEX STANDARD representative should perform all component replacement and service, or the warranty policy may be void. The following procedures cover adjustments that are not normally required once the transceiver has left the factory. However, if damage occurs and some parts are subsequently replaced, realignment may be required. If a sudden problem occurs during normal operation, it is likely due to component failure; realignment should not be done until after the faulty component has been replaced. We recommend that servicing be performed only by authorized VERTEX STANDARD service technicians who are experienced with the circuitry and fully equipped for repair and alignment. If a fault is suspected, contact the dealer from whom the transceiver was purchased for instructions regarding repair. Authorized VERTEX STANDARD service technicians realign all circuits and make complete performance checks to ensure compliance with factory specifications after replacing any faulty components. Those who do undertake any of the following alignments are cautioned to proceed at their own risk. Problems caused by unauthorized attempts at realignment are not covered by the warranty policy. In addition, VERTEX STANDARD reserves the right to change circuits and alignment procedures in the interest of improved performance, without notifying owners.

Under no circumstances should any alignment be attempted unless the normal function and operation of the transceiver is clearly understood, the cause of the malfunction has been clearly pinpointed, any faulty components are replaced, and realignment is determined to be absolutely necessary.

The following test equipment (and familiarity with its use) is necessary for complete realignment. Correction of problems caused by misalignment resulting from use of improper test equipment is not covered under the warranty policy. While most steps do not require all of the equipment listed, the interactions of some adjustments may require that additional adjustments be performed. Do not attempt to perform only a single step unless it is clearly isolated electrically from all other steps. Have all test equipment ready before beginning and, follow all of the steps in a section in the order presented.

## Required Test Equipment

- RF Signal Generator with calibrated output level at 500 MHz
- Deviation Meter (linear detector)
- In-line Wattmeter with 5% accuracy at 500 MHz
- 50-ohm, 10-W RF Dummy Load
- 8-ohm AF Dummy Load
- Regulated DC Power Supply adjustable from 3 to 15 VDC, 3A
- Frequency Counter: 0.2-ppm accuracy at 500 MHz
- AF Signal Generator
- AC Voltmeter
- DC Voltmeter: high impedance
- UHF Sampling Coupler
- SINAD Meter

## Alignment Preparation & Precautions

A 10 W RF dummy load and in-line wattmeter must be connected to the main antenna jack in all procedures that call for transmission, alignment is not possible with an antenna. After completing one step, read the next step to see if the same test equipment is required. If not, remove the test equipment (except dummy load and wattmeter, if connected) before proceeding.

Correct alignment requires that the ambient temperature of the transceiver be the same as that of the test equipment, and that the temperature be held constant between 68 ~ 86 °F (20 ~ 30 °C). When the transceiver is brought into the shop from hot or cold air, it should be allowed some time to come to room temperature before alignment. Whenever possible, alignments should be made with oscillator shields and circuit boards firmly affixed in place. The test equipment must be thoroughly warmed up before beginning.

*Note: Signal levels in dB referred to in the alignment procedure are based on 0 dB $\mu$ =0.5  $\mu$ V (closed circuit).*

## Test Setup

Set up the test equipment as shown below for transceiver alignment, and apply 4.4 V DC power to the transceiver. Refer to the drawings for Alignment Points.

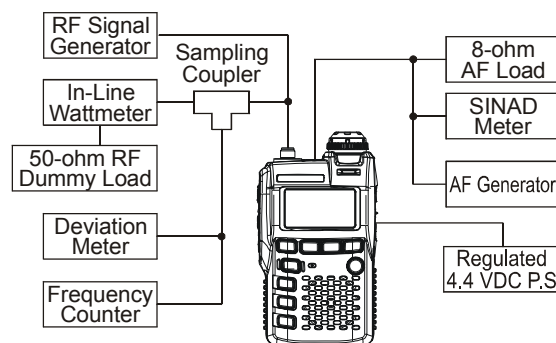

Alignment Setup

# Alignment

## Internal System Alignment Routine

This uses a programmed routine in the transceiver, which simplifies many previously complex discrete component settings and adjustments with digitally controlled settings via front panel buttons and LCD indications.

To enter the alignment mode:

- Program the alignment password "AH028M" into the CW ID memory via the Set Mode Item 19: CW ID. (See the box below for programming the alignment password.)
- Turn off the transceiver.
- Press and hold in the [TXPO] button while powering the radio on to enter the alignment mode.
- In the alignment mode, each adjustment item is shown on the LCD in the Memory Channel Number display slot, and is selected by rotating the DIAL knob.

To exit the alignment mode:

- Press the [HM/RV] button.
- Clear the alignment password from the CW ID memory, and program the user's CW ID, if needed.

**Warning!:** Do not change the alignment items which are not described in the adjustment procedures.

### Programming the Alignment Password

1. Press and hold in the [TXPO] key for one second to enter the Set mode.
2. Rotate the DIAL knob to select Set Mode Item 19: CW ID.  
Note: Do not forget to pull the DIAL knob to rotate the DIAL knob.
3. Press the [TXPO] key momentarily to enable adjustment of this Set Mode Item.
4. Rotate the DIAL knob to set this Item to "ON".
5. Press the [V/M] key momentarily to display any previously stored callsign.  
Note the previously stored call sign, so you can re-enter it later.
6. Press and hold the [HM/RV] key for 2 seconds to clear any previous callsign.
7. Rotate the DIAL knob to select the "A", then press the [V/M] key momentarily to save the "A" and move on to the next character.
8. Repeat the previous step to complete the alignment password "AH028M".
9. Press the [TXPO] key momentarily, then press the PTT switch to save the settings and exit to normal operation.

## PLL Reference Frequency Adjustment (REF)

- Rotate the DIAL knob to select the alignment item "rEF".
- Press the [V/M] key.
- Press the PTT switch, then rotate the DIAL knob so that the Frequency Counter reading is 440.000 MHz  $\pm$ 200 Hz.
- Press the [V/M] key again.

## 430 MHz band

### RX Tune Adjustment

- Connect the RF Signal Generator to the ANT jack, and then set the output level to -10 dB $\mu$ V at the 435.100 MHz (with 1 kHz tone @  $\pm$ 3.5 kHz deviation).
- Connect the SINAD meter to the MIC/SP jack
- Rotate the DIAL knob one click counter-clockwise to select the alignment item "tUn".
- Press the [V/M] key.
- Rotate the DIAL knob for minimum deflection of the SINAD meter.
- Press the [V/M] key again.

### Squelch Threshold Adjustment

- Connect the RF Signal Generator to the ANT jack, and then set the output level to -12 dB $\mu$ V at the 435.100 MHz (with 1 kHz tone @  $\pm$ 3.5 kHz deviation).
- Rotate the DIAL knob three clicks clockwise to select the alignment item "tHL".
- Press the [V/M] key.
- Press the [FW] key twice, and then press the [V/M] key again.

### Squelch Tight Adjustment

- Connect the RF Signal Generator to the ANT jack, and then set the output level to -5 dB $\mu$  at the 435.100 MHz (with 1 kHz tone @  $\pm$ 3.5 kHz deviation).
- Rotate the DIAL knob one click clockwise to select the alignment item "tIg".
- Press the [V/M] key.
- Press the [FW] key twice, and then press the [V/M] key again.

### NFM S-Meter S-1 Adjustment

- Connect the RF Signal Generator to the ANT jack, and then set the output level to -7 dB $\mu$ V at the 435.100 MHz (with 1 kHz tone @  $\pm$ 3.5 kHz deviation).
- Rotate the DIAL knob one click clockwise to select the alignment item "S1".
- Press the [V/M] key.
- Press the [FW] key twice, and then press the [V/M] key again.

## NFM S-Meter Full Scale Adjustment

- Connect the RF Signal Generator to the ANT jack, and then set the output level to +20 dB $\mu$ V at the 435.100 MHz (with 1 kHz tone @  $\pm 3.5$  kHz deviation).
- Rotate the DIAL knob one click clockwise to select the alignment item "S9".
- Press the [V/M] key.
- Press the [FW] key twice, and then press the [V/M] key again.

## WFM S-Meter S-1 Adjustment

- Connect the RF Signal Generator to the ANT jack, and then set the output level to 0 dB $\mu$ V at the 435.100 MHz (with 1 kHz tone @  $\pm 20$  kHz deviation).
- Rotate the DIAL knob one click clockwise to select the alignment item "S1".
- Press the [V/M] key.
- Press the [FW] key twice, and then press the [V/M] key again.

## WFM S-Meter Full Scale Adjustment

- Connect the RF Signal Generator to the ANT jack, and then set the output level to +20 dB $\mu$ V at the 435.100 MHz (with 1 kHz tone @  $\pm 20$  kHz deviation).
- Rotate the DIAL knob one click clockwise to select the alignment item "S9".
- Press the [V/M] key.
- Press the [FW] key twice, and then press the [V/M] key again.

## High TX Power Adjustment

- Connect the 50-Ohm Dummy Load and Wattmeter to the ANT jack.
- Increase the DC power supply voltage to 6.0 V.
- Rotate the DIAL knob one click clockwise to select the alignment item "HHP".
- Press the [V/M] key.
- Press the PTT switch, then rotate the DIAL knob so that the Wattmeter reading is 2.0 W  $\pm 0.1$  W.
- Reduce the DC power supply voltage to 4.4 V.
- Rotate the DIAL knob one click clockwise to select the alignment item "HP".
- Press the [V/M] key.
- Press the PTT switch, then rotate the DIAL knob so that the Wattmeter reading is 1.0 W  $\pm 0.1$  W.
- Press the [V/M] key again.

## Low TX Power Adjustment

- Connect the 50-Ohm Dummy Load and Wattmeter to the ANT jack.
- Rotate the DIAL knob one click clockwise to select the alignment item "LP".
- Press the [V/M] key.
- Press the PTT switch, then rotate the DIAL knob so that the Wattmeter reading is 0.1 W  $\pm 0.05$  W.
- Press the [V/M] key again.

## MAX Deviation Adjustment

- Connect the 50-Ohm Dummy Load, Wattmeter, and Deviation Meter to the ANT jack.
- Connect the AF Generator to the MIC/SP jack, and then set the output level to 50 mV at 1 kHz.
- Rotate the DIAL knob one click clockwise to select the alignment item "dEV".
- Press the [V/M] key.
- Press the PTT switch, then rotate the DIAL knob so that the Deviation meter reading is 4.2 kHz  $\pm 0.1$  kHz.
- Press the [V/M] key again.

## CTCSS Tone Deviation Adjustment

- Connect the 50-Ohm Dummy Load, Wattmeter, and Deviation Meter to the ANT jack.
- Rotate the DIAL knob one click clockwise to select the alignment item "100".
- Press the [V/M] key.
- Press the PTT switch, then rotate the DIAL knob so that the Deviation meter reading is 0.65 kHz  $\pm 0.05$  kHz.
- Press the [V/M] key again.

## DCS Deviation Adjustment

- Connect the 50-Ohm Dummy Load, Wattmeter, and Deviation Meter to the ANT jack.
- Rotate the DIAL knob one click clockwise to select the alignment item "dCS".
- Press the [V/M] key.  
Press the PTT switch, then rotate the DIAL knob so that the Deviation meter reading is 0.65 kHz  $\pm 0.05$  kHz.
- Press the [V/M] key again.

# Alignment

## 50 MHz band

Press the [**BAND**] button to switch the alignment band to 50 MHz Band.

### Squelch Threshold Adjustment

- Connect the RF Signal Generator to the ANT jack, and then set the output level to -4 dB $\mu$ V at the 52.100 MHz (with 1 kHz tone @  $\pm$ 3.5 kHz deviation).
- Rotate the DIAL knob one click clockwise to select the alignment item "tHL".
- Press the [**V/M**] key.
- Press the [**FW**] key twice, and then press the [**V/M**] key again.

### Squelch Tight Adjustment

- Connect the RF Signal Generator to the ANT jack, and then set the output level to +3 dB $\mu$ V at the 52.100 MHz (with 1 kHz tone @  $\pm$ 3.5 kHz deviation).
- Rotate the DIAL knob one click clockwise to select the alignment item "tIg".
- Press the [**V/M**] key.
- Press the [**FW**] key twice, and then press the [**V/M**] key again.

### NFM S-Meter S-1 Adjustment

- Connect the RF Signal Generator to the ANT jack, and then set the output level to 0 dB $\mu$ V at the 52.100 MHz (with 1 kHz tone @  $\pm$ 3.5 kHz deviation).
- Rotate the DIAL knob one click clockwise to select the alignment item "S1".
- Press the [**V/M**] key.
- Press the [**FW**] key twice, and then press the [**V/M**] key again.

### NFM S-Meter Full Scale Adjustment

- Connect the RF Signal Generator to the ANT jack, and then set the output level to +20 dB $\mu$ V at the 52.100 MHz (with 1 kHz tone @  $\pm$ 3.5 kHz deviation).
- Rotate the DIAL knob one click clockwise to select the alignment item "S9".
- Press the [**V/M**] key.
- Press the [**FW**] key twice, and then press the [**V/M**] key again.

### WFM S-Meter S-1 Adjustment

- Connect the RF Signal Generator to the ANT jack, and then set the output level to +8 dB $\mu$ V at the 52.100 MHz (with 1 kHz tone @  $\pm$ 20 kHz deviation).
- Rotate the DIAL knob one click clockwise to select the alignment item "S1".
- Press the [**V/M**] key.
- Press the [**FW**] key twice, and then press the [**V/M**] key again.

### WFM S-Meter Full Scale Adjustment

- Connect the RF Signal Generator to the ANT jack, and then set the output level to +25 dB $\mu$ V at the 52.100 MHz (with 1 kHz tone @  $\pm$ 20 kHz deviation).
- Rotate the DIAL knob one click clockwise to select the alignment item "S9".
- Press the [**V/M**] key.
- Press the [**FW**] key twice, and then press the [**V/M**] key again.

## **144 MHz Band**

Press the [**BAND**] button to switch the alignment band to 144 MHz Band.

### RX Tune Adjustment

- Connect the RF Signal Generator to the ANT jack, and then set the output level to -10 dB $\mu$ V at the 145.100 MHz (with 1 kHz tone @  $\pm$ 3.5 kHz deviation).
- Connect the SINAD meter to the MIC/SP jack
- Rotate the DIAL knob clockwise until the alignment item "tUn" appears.
- Press the [**V/M**] key.
- Rotate the DIAL knob for minimum deflection of the SINAD meter.
- Press the [**V/M**] key again.

### Squelch Threshold Adjustment

- Connect the RF Signal Generator to the ANT jack, and then set the output level to -12 dB $\mu$ V at the 145.100 MHz (with 1 kHz tone @  $\pm$ 3.5 kHz deviation).
- Rotate the DIAL knob counter-clockwise until the alignment item "tHL" appears
- Press the [**V/M**] key.
- Press the [**F/W**] key twice, and then press the [**V/M**] key again.

### Squelch Tight Adjustment

- Connect the RF Signal Generator to the ANT jack, and then set the output level to -5 dB $\mu$ V at the 145.100 MHz (with 1 kHz tone @  $\pm$ 3.5 kHz deviation).
- Rotate the DIAL knob one click clockwise to select the alignment item "tIg".
- Press the [**V/M**] key.
- Press the [**F/W**] key twice, and then press the [**V/M**] key again.

### NFM S-Meter S-1 Adjustment

- Connect the RF Signal Generator to the ANT jack, and then set the output level to -7 dB $\mu$ V at the 145.100 MHz (with 1 kHz tone @  $\pm$ 3.5 kHz deviation).
- Rotate the DIAL knob one click clockwise to select the alignment item "S1".
- Press the [**V/M**] key.
- Press the [**F/W**] key twice, and then press the [**V/M**] key again.

### NFM S-Meter Full Scale Adjustment

- Connect the RF Signal Generator to the ANT jack, and then set the output level to +20 dB $\mu$ V at the 145.100 MHz (with 1 kHz tone @  $\pm$ 3.5 kHz deviation).
- Rotate the DIAL knob one click clockwise to select the alignment item "S9".
- Press the [**V/M**] key.
- Press the [**F/W**] key twice, and then press the [**V/M**] key again.

### WFM S-Meter S-1 Adjustment

- Connect the RF Signal Generator to the ANT jack, and then set the output level to 0 dB $\mu$ V at the 145.100 MHz (with 1 kHz tone @  $\pm$ 20 kHz deviation).
- Rotate the DIAL knob one click clockwise to select the alignment item "S1".
- Press the [**V/M**] key.
- Press the [**F/W**] key twice, and then press the [**V/M**] key again.

### WFM S-Meter Full Scale Adjustment

- Connect the RF Signal Generator to the ANT jack, and then set the output level to +20 dB $\mu$ V at the 145.100 MHz (with 1 kHz tone @  $\pm$ 20 kHz deviation).
- Rotate the DIAL knob one click clockwise to select the alignment item "S9".
- Press the [**V/M**] key.
- Press the [**F/W**] key twice, and then press the [**V/M**] key again.

### High TX Power Adjustment

- Connect the 50-Ohm Dummy Load and Wattmeter to the ANT jack.
- Increase the DC power supply voltage to 6.0 V
- Rotate the DIAL knob one click clockwise to select the alignment item "HHP".
- Press the [**V/M**] key.
- Press the PTT switch, then rotate the DIAL knob so that the Wattmeter reading is 2.9 W  $\pm$ 0.1 W.
- Reduce the DC power supply voltage to 4.4 V
- Rotate the DIAL knob one click clockwise to select the alignment item "HP".
- Press the [**V/M**] key.
- Press the PTT switch, then rotate the DIAL knob so that the Wattmeter reading is 1.5 W  $\pm$ 0.1 W.
- Press the [**V/M**] key again.

# Alignment

## Low TX Power Adjustment

- Connect the 50-Ohm Dummy Load and Wattmeter to the ANT jack.
- Rotate the DIAL knob one click clockwise to select the alignment item "LP".
- Press the [V/M] key.
- Press the PTT switch, then rotate the DIAL knob so that the Wattmeter reading is  $0.1\text{ W} \pm 0.05\text{ W}$ .
- Press the [V/M] key again.

## MAX Deviation Adjustment

- Connect the 50-Ohm Dummy Load, Wattmeter, and Deviation Meter to the ANT jack.
- Connect the AF Generator to the MIC/SP jack, and then set the output level to 50 mV at 1 kHz.
- Rotate the DIAL knob one click clockwise to select the alignment item "dEV".
- Press the [V/M] key.
- Press the PTT switch, then rotate the DIAL knob so that the Deviation meter reading is  $4.2\text{ kHz} \pm 0.1\text{ kHz}$ .
- Press the [V/M] key again.

## CTCSS Tone Deviation Adjustment

- Connect the 50-Ohm Dummy Load, Wattmeter, and Deviation Meter to the ANT jack.
- Rotate the DIAL knob one click clockwise to select the alignment item "100".
- Press the [V/M] key.
- Press the PTT switch, then rotate the DIAL knob so that the Deviation meter reading is  $0.65\text{ kHz} \pm 0.05\text{ kHz}$ .
- Press the [V/M] key again.

## DCS Deviation Adjustment

- Connect the 50-Ohm Dummy Load, Wattmeter, and Deviation Meter to the ANT jack.
- Rotate the DIAL knob one click clockwise to select the alignment item "dCS".
- Press the [V/M] key.
- Press the PTT switch, then rotate the DIAL knob so that the Deviation meter reading is  $0.65\text{ kHz} \pm 0.05\text{ kHz}$ .
- Press the [V/M] key again.

This completes the internal alignment routine for all bands. To save all settings and exit, press the [HM/RV] button.

# MAIN Unit Circuit Diagram

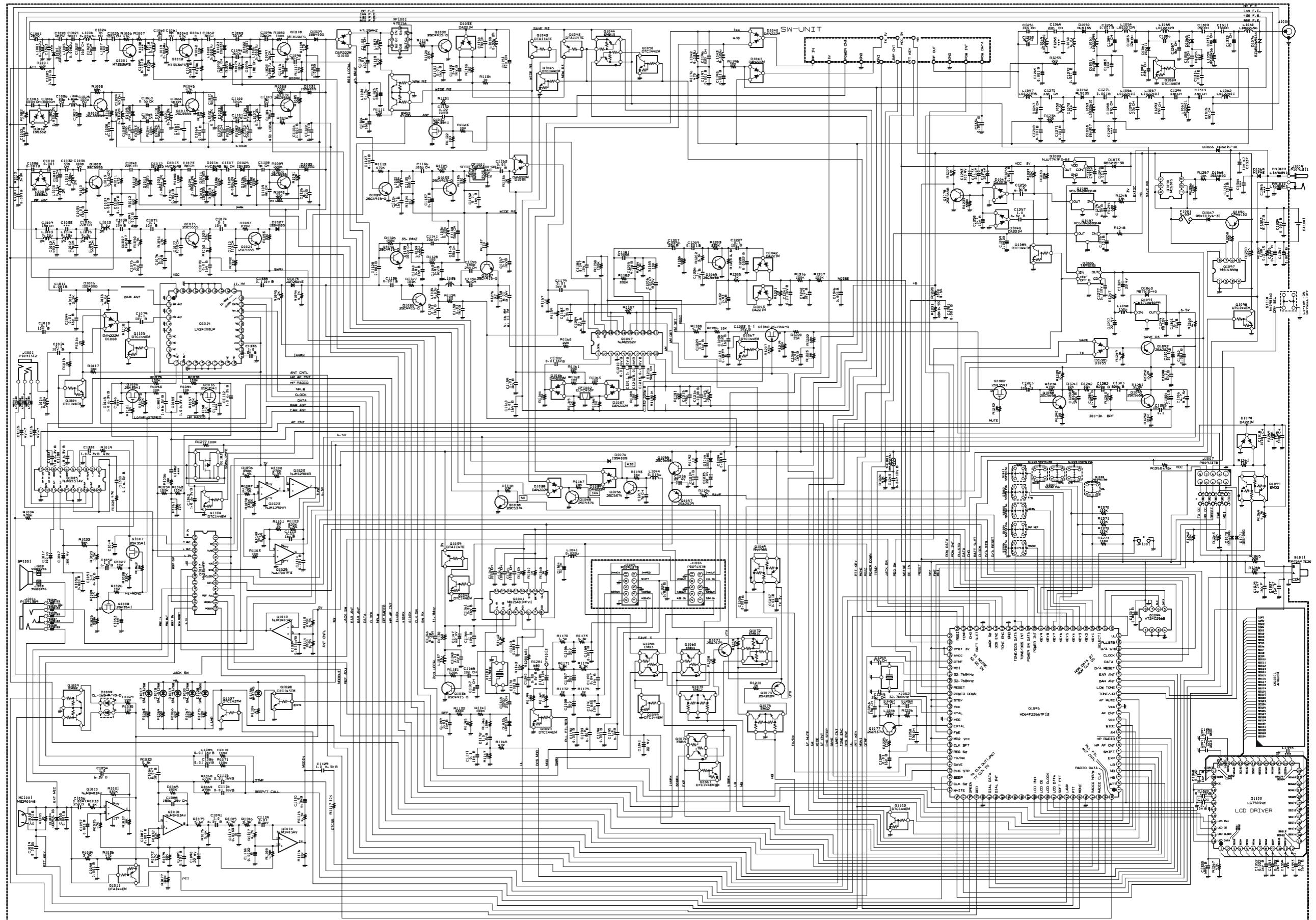

Downloaded by  
RadioAmateur.EU

## *MAIN Unit*

*Note*



# MAIN Unit

## Parts Layout (Side A)

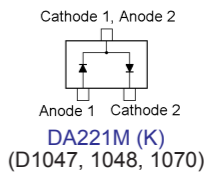
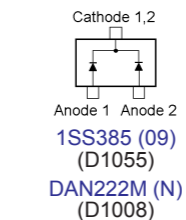
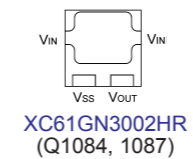
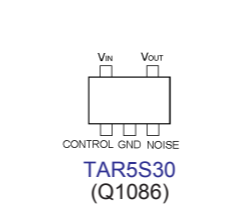
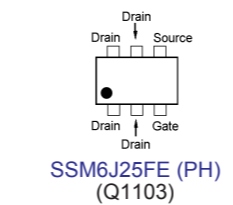
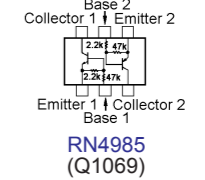
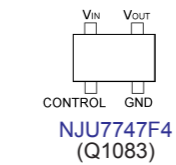
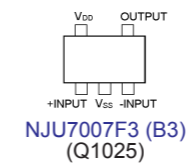
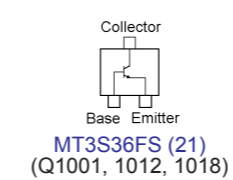
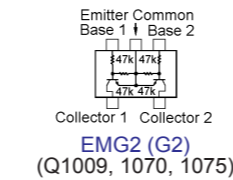
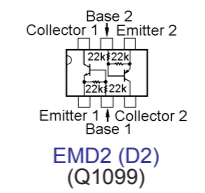
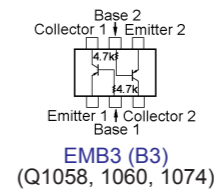
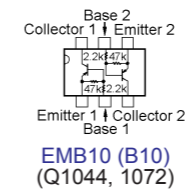
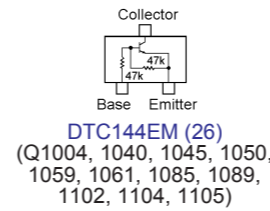
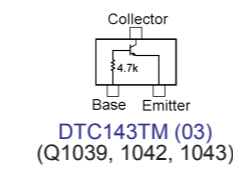
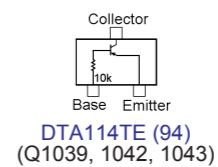
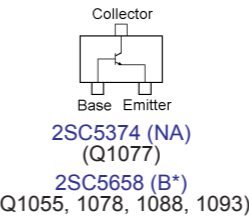
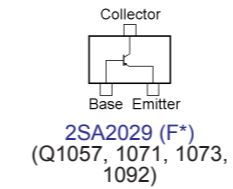
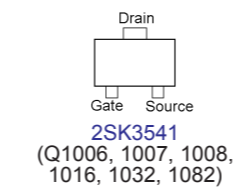
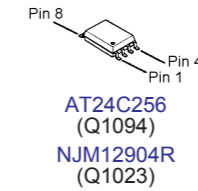
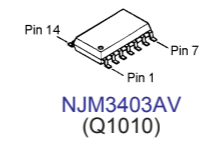
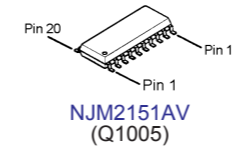
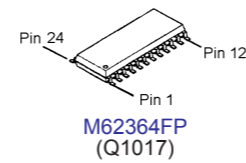
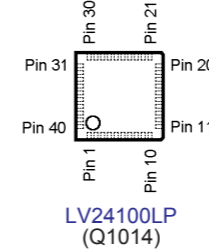
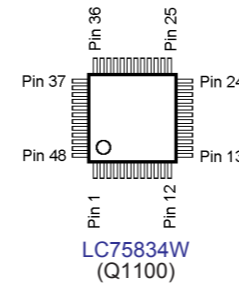
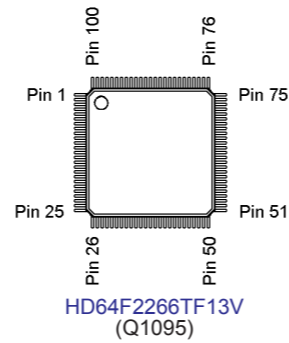
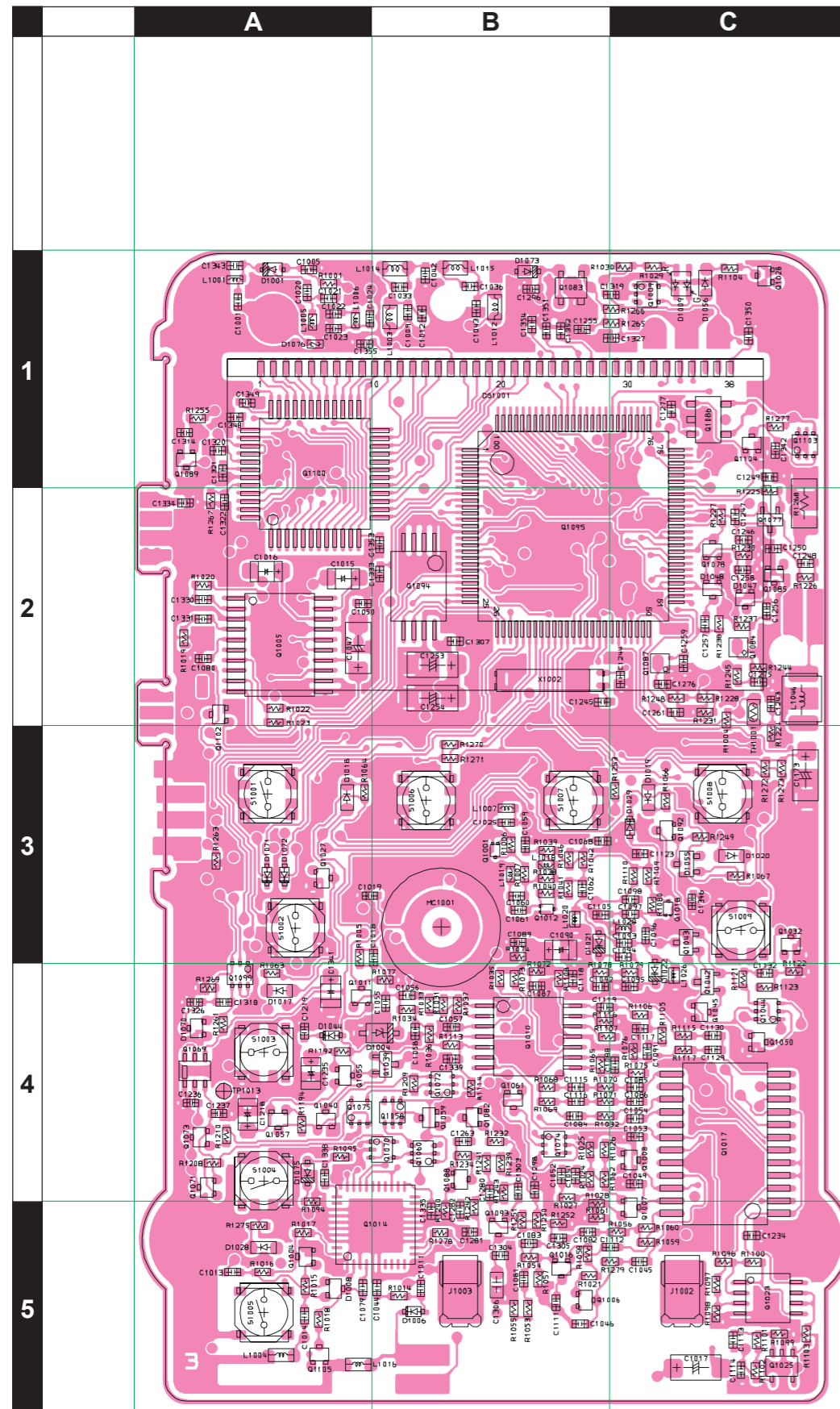

# MAIN Unit

## Parts Layout (Side B)

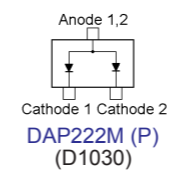
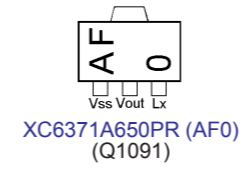
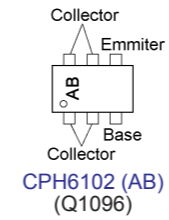
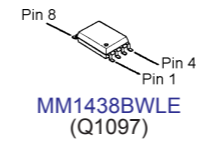
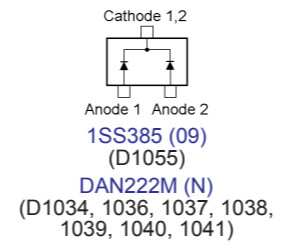
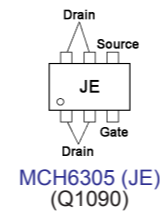
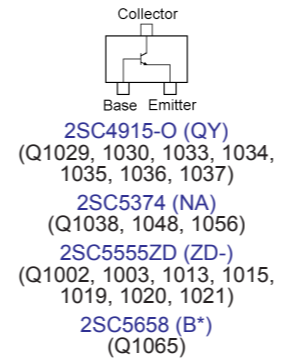
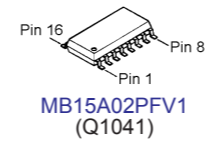
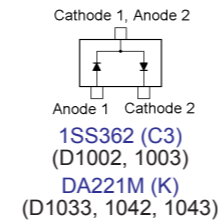
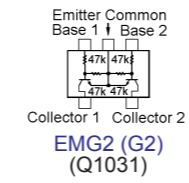
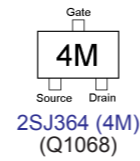
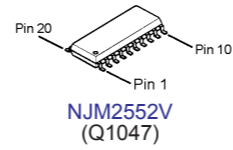

Downloaded by  
**RadioAmateur.EU**

# Main Unit

## Parts List

REF	DESCRIPTION	VALUE	V/W	TOL.	MFR'S DESIG	VXSTD P/N	VERS.	LOT	SIDE	LAY ADR
P.C.B. with Components (W/ SW Unit, VCO Unit)						CP8966001	DST:USA	TYP:A2U		
						CP8966003	DST:EXP	TYP:A1		
						CP8966004	DST:EXP	TYP:A2		
						CP8966005	DST:EXP	TYP:A3		
						CP8966006	DST:EU	TYP:B1		
						CP8966007	DST:EU	TYP:B2		
						CP8966008	DST:EXP	TYP:B3		
						CP8966009	DST:EU	TYP:C1		
						CP8966010	DST:EU	TYP:C2		
						CP8966011	DST:EXP	TYP:C3		
						CP8966012	DST:EU	TYP:D1		
						CP8966013	DST:EU	TYP:D2		
						CP8966014	DST:AUS	TYP:H1		
						CP8966015	DST:AUS	TYP:H2		
Printed Circuit Board						FR0158600		1-		
C 1001	CHIP CAP.	2pF	50V	CK	UMK105CK020CW-F	K22178250		1-	A	A1
C 1002	CHIP CAP.	0.001uF	50V	B	UMK105B102KW-F	K22178829		1-	B	c3
C 1003	CHIP CAP.	100pF	50V	CH	UMK105CH101JW-F	K22178282		1-	B	c2
C 1004	CHIP CAP.	100pF	50V	CH	UMK105CH101JW-F	K22178282		1-	B	c2
C 1005	CHIP CAP.	0.001uF	50V	B	GRM155B11H102KA01D	K22178809		1-	A	A1
C 1006	CHIP CAP.	33pF	50V	CH	UMK105CH330JW-F	K22178270		1-	B	c3
C 1007	CHIP CAP.	0.001uF	50V	B	UMK105B102KW-F	K22178829		1-	B	c2
C 1008	CHIP CAP.	0.001uF	50V	B	UMK105B102KW-F	K22178829		1-	B	c2
C 1009	CHIP CAP.	15pF	50V	CH	UMK105CH150JW-F	K22178262		1-	A	B1
C 1010	CHIP CAP.	0.001uF	50V	B	UMK105B102KW-F	K22178829		1-	B	c2
C 1011	CHIP CAP.	0.001uF	50V	B	UMK105B102KW-F	K22178829		1-	A	B5
C 1012	CHIP CAP.	68pF	50V	CH	UMK105CH680JW-F	K22178278		1-	A	B1
C 1013	CHIP CAP.	0.1uF	10V	B	GRM155B11A104KA01D	K22108802		1-	A	A5
C 1014	CHIP CAP.	0.1uF	10V	B	GRM155B11A104KA01D	K22108802		1-	A	A5
C 1015	CHIP TA.CAP.	47uF	4V		TEESVP0G476M8R	K78060050		1-	A	A2
C 1016	CHIP TA.CAP.	47uF	4V		TEESVP0G476M8R	K78060050		1-	A	A2
C 1017	CHIP TA.CAP.	100uF	4V		TEESVA0G107M8R	K78060051		1-	A	C5
C 1018	CHIP CAP.	0.001uF	50V	B	UMK105B102KW-F	K22178829		1-	A	A3
C 1019	CHIP CAP.	0.001uF	50V	B	UMK105B102KW-F	K22178829		1-	A	A3
C 1020	CHIP CAP.	2pF	50V	CK	GRM1554C1H2R0CZ01D	K22178204		1-	A	A1
C 1021	CHIP CAP.	5pF	50V	CH	UMK105CH050CW-F	K22178253		1-	A	A1
C 1022	CHIP CAP.	10pF	50V	CH	UMK105CH100DW-F	K22178258		1-	A	A1
C 1023	CHIP CAP.	12pF	50V	CH	GRM1552C1H120JZ01D	K22178214		1-	A	A1
C 1024	CHIP CAP.	7pF	50V	CH	UMK105CH070DW-F	K22178255		1-	A	A1
C 1025	CHIP CAP.	100pF	50V	CH	UMK105CH101JW-F	K22178282		1-	A	B3
C 1026	CHIP CAP.	100pF	50V	CH	UMK105CH101JW-F	K22178282		1-	B	c3
C 1028	CHIP CAP.	0.001uF	50V	B	UMK105B102KW-F	K22178829		1-	B	c3
C 1029	CHIP CAP.	4pF	50V	CH	UMK105CH040CW-F	K22178252		1-	B	c3
C 1030	CHIP CAP.	220pF	25V	CH	GRM36CH221J25PT	K22148203		1-	B	c3
C 1031	CHIP CAP.	68pF	50V	CH	UMK105CH680JW-F	K22178278		1-	B	c2
C 1032	CHIP CAP.	33pF	50V	CH	UMK105CH330JW-F	K22178270		1-	B	c2
C 1034	CHIP CAP.	100pF	50V	CH	UMK105CH101JW-F	K22178282		1-	B	c3
C 1035	CHIP CAP.	0.01uF	16V	B	GRM36B103K16PT	K22128804		1-	B	c2
C 1036	CHIP CAP.	22pF	50V	CH	UMK105CH220JW-F	K22178266		1-	A	B1
C 1037	CHIP CAP.	0.001uF	50V	B	UMK105B102KW-F	K22178829		1-	B	c3
C 1038	CHIP CAP.	0.1uF	10V	B	GRM155B11A104KA01D	K22108802		1-	B	c3
C 1039	CHIP CAP.	0.1uF	10V	B	GRM155B11A104KA01D	K22108802		1-	B	c3
C 1040	CHIP CAP.	22pF	50V	CH	UMK105CH220JW-F	K22178266		1-	B	b3
C 1041	CHIP CAP.	0.001uF	50V	B	UMK105B102KW-F	K22178829		1-	B	b3
C 1042	CHIP CAP.	47pF	50V	CH	UMK105CH470JW-F	K22178274		1-	A	B1
C 1043	CHIP CAP.	56pF	50V	CH	UMK105CH560JW-F	K22178276		1-	A	B1
C 1044	CHIP CAP.	0.01uF	16V	B	GRM36B103K16PT	K22128804		1-	A	A5
C 1045	CHIP CAP.	1uF	6.3V	B	GRM155B30J105KE18D	K22088803		1-	A	B5
C 1046	CHIP CAP.	0.001uF	50V	B	UMK105B102KW-F	K22178829		1-	A	B5
C 1047	CHIP TA.CAP.	100uF	4V		TEESVA0G107M8R	K78060051		1-	A	A2
C 1051	CHIP CAP.	1uF	6.3V	B	GRM155B30J105KE18D	K22088803		1-	A	B4
C 1052	CHIP CAP.	1uF	6.3V	B	GRM155B30J105KE18D	K22088803		1-	A	B4
C 1054	CHIP CAP.	1uF	6.3V	B	GRM155B30J105KE18D	K22088803		1-	A	B4
C 1055	CHIP CAP.	0.001uF	50V	B	UMK105B102KW-F	K22178829		1-	A	A4
C 1056	CHIP CAP.	0.0047uF	25V	B	TMK105B472KW-F	K22148831		1-	A	B4
C 1057	CHIP CAP.	0.001uF	50V	B	UMK105B102KW-F	K22178829		1-	A	B4
C 1058	CHIP CAP.	0.001uF	50V	B	UMK105B102KW-F	K22178829		1-	A	B4
C 1059	CHIP CAP.	0.001uF	50V	B	GRM155B11H102KA01D	K22178809		1-	A	B3
C 1060	CHIP CAP.	3pF	50V	CJ	UMK105CJ030CW-F	K22178251		1-	A	B3
C 1061	CHIP CAP.	8pF	50V	CH	GRM1552C1H8R0DZ01D	K22178210		1-	A	B3
C 1062	CHIP CAP.	3pF	50V	CJ	UMK105CJ030CW-F	K22178251		1-	A	B3
C 1063	CHIP CAP.	0.5pF	50V	CK	UMK105CK0R5CW-F	K22178247		1-	B	c3
C 1064	CHIP CAP.	2pF	50V	CK	UMK105CK020CW-F	K22178250		1-	B	c3

# Main Unit

## Parts List

REF	DESCRIPTION	VALUE	V/W	TOL.	MFR'S DESIG	VXSTD P/N	VERS.	LOT	SIDE	LAY ADR
C 1065	CHIP CAP.	56pF	50V	CH	UMK105CH560JW-F	K22178276		1-	B	c3
C 1066	CHIP CAP.	4pF	50V	CH	UMK105CH040CW-F	K22178252		1-	B	c3
C 1067	CHIP CAP.	0.001uF	50V	B	UMK105B102KW-F	K22178829		1-	B	b3
C 1068	CHIP CAP.	0.001uF	50V	B	GRM155B11H102KA01D	K22178809		1-	A	B3
C 1069	CHIP CAP.	0.001uF	50V	B	UMK105B102KW-F	K22178829		1-	B	c3
C 1070	CHIP CAP.	4pF	50V	CH	UMK105CH040CW-F	K22178252		1-	B	b3
C 1071	CHIP CAP.	0.1uF	10V	B	GRM155B11A104KA01D	K22108802		1-	B	c3
C 1072	CHIP CAP.	0.001uF	50V	B	UMK105B102KW-F	K22178829		1-	B	b3
C 1073	CHIP CAP.	8pF	50V	CH	UMK105CH080DW-F	K22178256		1-	B	b3
C 1074	CHIP CAP.	0.1uF	10V	B	GRM155B11A104KA01D	K22108802		1-	B	b3
C 1075	CHIP CAP.	0.01uF	16V	B	GRM36B103K16PT	K22128804		1-	B	c3
C 1076	CHIP CAP.	0.01uF	16V	B	GRM36B103K16PT	K22128804		1-	B	b3
C 1077	CHIP CAP.	100pF	50V	CH	UMK105CH101JW-F	K22178282		1-	B	b3
C 1078	CHIP CAP.	0.01uF	16V	B	GRM36B103K16PT	K22128804		1-	B	b3
C 1079	CHIP CAP.	0.1uF	10V	B	GRM155B11A104KA01D	K22108802		1-	A	A5
C 1080	CHIP CAP.	1uF	6.3V	B	GRM155B30J105KE18D	K22088803		1-	A	A2
C 1084	CHIP CAP.	0.1uF	10V	B	GRM155B11A104KA01D	K22108802		1-	A	B4
C 1085	CHIP CAP.	0.01uF	16V	B	GRM36B103K16PT	K22128804		1-	A	B4
C 1086	CHIP CAP.	0.01uF	16V	B	GRM36B103K16PT	K22128804		1-	A	B4
C 1087	CHIP CAP.	0.001uF	50V	B	UMK105B102KW-F	K22178829		1-	A	B4
C 1088	CHIP CAP.	180pF	25V	CH	TMK105CH181JW-F	K22148244		1-	A	B4
C 1089	CHIP CAP.	0.001uF	50V	B	UMK105B102KW-F	K22178829		1-	A	B3
C 1090	CHIP TA.CAP.	22uF	4V		TESVSP0G226M-8R	K78060047		1-	A	B3
C 1091	CHIP CAP.	1uF	6.3V	B	GRM155B30J105KE18D	K22088803		1-	A	C4
C 1092	CHIP CAP.	18pF	50V	CH	UMK105CH180JW-F	K22178264		1-	A	B4
C 1093	CHIP CAP.	1pF	50V	CK	UMK105CK010CW-F	K22178248		1-	A	B3
C 1094	CHIP CAP.	2pF	50V	CK	GRM1554C1H2R0CZ01D	K22178204		1-	A	B3
C 1095	CHIP CAP.	18pF	50V	CH	UMK105CH180JW-F	K22178264		1-	A	B4
C 1096	CHIP CAP.	12pF	50V	CH	GRM1552C1H120JZ01D	K22178214		1-	A	C3
C 1097	CHIP CAP.	2pF	50V	CK	GRM1554C1H2R0CZ01D	K22178204		1-	A	B3
C 1098	CHIP CAP.	3pF	50V	CJ	UMK105CJ030CW-F	K22178251		1-	A	B3
C 1099	CHIP CAP.	56pF	50V	CH	UMK105CH560JW-F	K22178276		1-	B	b3
C 1100	CHIP CAP.	1pF	50V	CK	UMK105CK010CW-F	K22178248		1-	B	b3
C 1101	CHIP CAP.	2pF	50V	CK	UMK105CK020CW-F	K22178250		1-	B	b3
C 1102	CHIP CAP.	56pF	50V	CH	UMK105CH560JW-F	K22178276		1-	B	b3
C 1103	CHIP CAP.	3pF	50V	CJ	UMK105CJ030CW-F	K22178251		1-	B	b3
C 1104	CHIP CAP.	3pF	50V	CJ	UMK105CJ030CW-F	K22178251		1-	B	b3
C 1105	CHIP CAP.	5pF	50V	CH	UMK105CH050CW-F	K22178253		1-	A	B3
C 1106	CHIP CAP.	0.001uF	50V	B	UMK105B102KW-F	K22178829		1-	B	b3
C 1107	CHIP CAP.	8pF	50V	CH	UMK105CH080DW-F	K22178256		1-	B	b2
C 1108	CHIP CAP.	9pF	50V	CH	UMK105CH090DW-F	K22178257		1-	B	b3
C 1109	CHIP CAP.	2pF	50V	CK	UMK105CK020CW-F	K22178250		1	B	b3
C 1109	CHIP CAP.	1pF	50V	CK	GRM1554C1H1R0BZ01D	K22178287		2-	B	b3
C 1110	CHIP CAP.	10pF	50V	CH	UMK105CH100DW-F	K22178258		1	B	b3
C 1110	CHIP CAP.	1pF	50V	CK	GRM1554C1H1R0BZ01D	K22178287		2-	B	b3
C 1111	CHIP CAP.	0.001uF	50V	B	UMK105B102KW-F	K22178829		1-	A	B5
C 1112	CHIP CAP.	1uF	6.3V	B	GRM155B30J105KE18D	K22088803		1-	A	B5
C 1113	CHIP CAP.	0.01uF	16V	B	GRM36B103K16PT	K22128804		1-	A	C5
C 1114	CHIP CAP.	0.001uF	50V	B	UMK105B102KW-F	K22178829		1-	A	C5
C 1115	CHIP CAP.	0.01uF	16V	B	GRM36B103K16PT	K22128804		1-	A	B4
C 1116	CHIP CAP.	0.01uF	16V	B	GRM36B103K16PT	K22128804		1-	A	B4
C 1117	CHIP CAP.	0.0033uF	50V	B	GRM155B11H332KA01D	K22178815		1-	A	B4
C 1118	CHIP CAP.	0.0033uF	50V	B	UMK105B332KW-F	K22178835		1-	A	B4
C 1119	CHIP CAP.	0.01uF	16V	B	GRM36B103K16PT	K22128804		1-	A	B4
C 1120	CHIP CAP.	33pF	50V	CH	UMK105CH330JW-F	K22178270		1-	B	a3
C 1121	CHIP CAP.	0.01uF	16V	B	GRM36B103K16PT	K22128804		1-	B	a3
C 1122	CHIP CAP.	0.1uF	10V	B	GRM155B11A104KA01D	K22108802		1-	B	b3
C 1123	CHIP CAP.	0.001uF	50V	B	GRM155B11H102KA01D	K22178809		1-	A	B3
C 1124	CHIP CAP.	0.01uF	16V	B	GRM36B103K16PT	K22128804		1-	B	a3
C 1125	CHIP CAP.	68pF	50V	CH	UMK105CH680JW-F	K22178278		1-	B	b3
C 1126	CHIP CAP.	0.1uF	10V	B	GRM155B11A104KA01D	K22108802		1-	B	b2
C 1127	CHIP CAP.	0.001uF	50V	B	UMK105B102KW-F	K22178829		1-	B	a3
C 1128	CHIP CAP.	0.001uF	50V	B	UMK105B102KW-F	K22178829		1-	B	c5
C 1129	CHIP CAP.	1uF	6.3V	B	GRM155B30J105KE18D	K22088803		1-	A	C4
C 1130	CHIP CAP.	1uF	6.3V	B	GRM155B30J105KE18D	K22088803		1-	A	C4
C 1131	CHIP CAP.	0.01uF	16V	B	GRM36B103K16PT	K22128804		1-	B	a3
C 1132	CHIP CAP.	0.22uF	10V	B	GRM155B31A224KE18D	K22108808		1-	A	C4
C 1133	CHIP CAP.	0.01uF	16V	B	GRM36B103K16PT	K22128804		1-	B	a4
C 1134	CHIP CAP.	0.01uF	16V	B	GRM36B103K16PT	K22128804		1-	B	a2
C 1135	CHIP CAP.	22pF	50V	CH	UMK105CH220JW-F	K22178266		1-	B	a2
C 1136	CHIP CAP.	100pF	50V	CH	UMK105CH101JW-F	K22178282		1-	B	a3
C 1137	CHIP CAP.	0.001uF	50V	B	UMK105B102KW-F	K22178829		1-	B	a3
C 1138	CHIP CAP.	0.001uF	50V	B	UMK105B102KW-F	K22178829		1-	B	c5

# Main Unit

## Parts List

REF	DESCRIPTION	VALUE	V/W	TOL.	MFR'S DESIG	VXSTD P/N	VERS.	LOT	SIDE	LAY ADR
C 1139	CHIP CAP.	100pF	50V	CH	UMK105CH101JW-F	K22178282		1-	B	b4
C 1140	CHIP CAP.	0.01uF	16V	B	GRM36B103K16PT	K22128804		1-	B	b4
C 1141	CHIP CAP.	10pF	50V	CH	UMK105CH100DW-F	K22178258		1-	B	b4
C 1142	CHIP CAP.	0.01uF	16V	B	GRM36B103K16PT	K22128804		1-	B	b5
C 1143	CHIP CAP.	0.01uF	16V	B	GRM36B103K16PT	K22128804		1-	B	b4
C 1144	CHIP CAP.	56pF	50V	CH	UMK105CH560JW-F	K22178276		1-	B	b4
C 1145	CHIP CAP.	33pF	50V	CH	UMK105CH330JW-F	K22178270		1-	B	b4
C 1146	CHIP CAP.	470pF	25V	B	TMK105B471K-F	K22148816		1-	B	c5
C 1147	CHIP TA.CAP.	22uF	4V		TESVSP0G226M-8R	K78060047		1-	B	c4
C 1148	CHIP CAP.	0.01uF	16V	B	GRM36B103K16PT	K22128804		1-	B	c4
C 1149	CHIP CAP.	0.01uF	16V	B	GRM36B103K16PT	K22128804		1-	B	c4
C 1150	CHIP CAP.	15pF	50V	CH	UMK105CH150JW-F	K22178262		1-	B	a3
C 1151	CHIP CAP.	10pF	50V	CH	UMK105CH100DW-F	K22178258		1-	B	a3
C 1152	CHIP CAP.	0.01uF	16V	B	GRM36B103K16PT	K22128804		1-	B	a2
C 1153	CHIP CAP.	0.01uF	16V	B	GRM36B103K16PT	K22128804		1-	B	a3
C 1154	CHIP CAP.	0.01uF	16V	B	GRM36B103K16PT	K22128804		1-	B	b5
C 1155	CHIP CAP.	180pF	25V	CH	GRM36CH181J25PT	K22148201		1-	B	b5
C 1156	CHIP CAP.	5pF	50V	CH	UMK105CH050CW-F	K22178253		1-	B	b5
C 1157	CHIP CAP.	0.01uF	16V	B	GRM36B103K16PT	K22128804		1-	B	b4
C 1158	CHIP CAP.	0.01uF	16V	B	GRM36B103K16PT	K22128804		1-	B	b5
C 1159	CHIP CAP.	0.01uF	16V	B	GRM36B103K16PT	K22128804		1-	B	a5
C 1160	CHIP CAP.	0.01uF	16V	B	GRM36B103K16PT	K22128804		1-	B	a4
C 1161	CHIP CAP.	0.01uF	16V	B	GRM36B103K16PT	K22128804		1-	B	c3
C 1162	CHIP CAP.	100pF	50V	CH	UMK105CH101JW-F	K22178282		1-	B	c4
C 1163	CHIP CAP.	100pF	50V	CH	UMK105CH101JW-F	K22178282		1-	B	c4
C 1164	CHIP CAP.	100pF	50V	CH	UMK105CH101JW-F	K22178282		1-	B	b4
C 1165	CHIP CAP.	10pF	50V	CH	UMK105CH100DW-F	K22178258		1-	B	c4
C 1166	CHIP CAP.	0.1uF	10V	B	GRM155B11A104KA01D	K22108802		1-	B	c4
C 1167	CHIP CAP.	18pF	50V	CH	UMK105CH180JW-F	K22178264		1-	B	c4
C 1168	CHIP CAP.	220pF	25V	CH	GRM36CH221J25PT	K22148203		1-	B	c4
C 1169	CHIP CAP.	0.001uF	50V	B	UMK105B102KW-F	K22178829		1-	B	c4
C 1170	CHIP CAP.	0.001uF	50V	B	UMK105B102KW-F	K22178829		1-	B	c3
C 1171	CHIP CAP.	0.1uF	10V	B	GRM155B11A104KA01D	K22108802		1-	B	b4
C 1172	CHIP CAP.	1uF	6.3V	B	GRM155B30J105KE18D	K22088803		1-	B	c4
C 1173	CHIP TA.CAP.	100uF	4V		TEESVA0G107M8R	K78060051		1-	A	C3
C 1179	CHIP CAP.	0.01uF	16V	B	GRM36B103K16PT	K22128804		1-	B	a4
C 1180	CHIP CAP.	0.047uF	10V	B	GRM155B11A473KA01D	K22108801		1-	B	a4
C 1181	CHIP CAP.	470pF	50V	B	UMK105B471KW-F	K22178825		1-	B	b4
C 1182	CHIP CAP.	0.01uF	16V	B	GRM36B103K16PT	K22128804		1-	B	a4
C 1183	CHIP CAP.	4.7uF	6.3V	B	JMK107BJ475MA-T	K22084803		1-	B	a4
C 1184	CHIP CAP.	7pF	50V	CH	UMK105CH070DW-F	K22178255		1-	B	b4
C 1185	CHIP TA.CAP.	4.7uF	6.3V		TESVSP0J475M-8R	K78080053		1-	B	c4
C 1186	CHIP TA.CAP.	0.1uF	20V		SKF-1D104M-RP	K78130049		1-	B	c4
C 1187	CHIP TA.CAP.	0.1uF	20V		SKF-1D104M-RP	K78130049		1-	B	c4
C 1188	CHIP TA.CAP.	0.1uF	20V		SKF-1D104M-RP	K78130049		1-	B	c4
C 1189	CHIP CAP.	0.001uF	50V	B	UMK105B102KW-F	K22178829		1-	B	c4
C 1190	CHIP CAP.	0.047uF	10V	B	GRM155B11A473KA01D	K22108801		1-	B	c3
C 1191	CHIP CAP.	0.033uF	10V	B	GRM155B11A333KA01D	K22108803		1-	B	c5
C 1192	CHIP CAP.	0.001uF	50V	B	UMK105B102KW-F	K22178829		1-	B	c4
C 1193	CHIP CAP.	1uF	6.3V	B	GRM155B30J105KE18D	K22088803		1-	B	c4
C 1194	CHIP CAP.	0.001uF	50V	B	UMK105B102KW-F	K22178829		1-	B	c4
C 1195	CHIP CAP.	1uF	6.3V	B	GRM155B30J105KE18D	K22088803		1-	B	c4
C 1197	CHIP CAP.	0.001uF	50V	B	UMK105B102KW-F	K22178829		1-	B	c3
C 1198	CHIP CAP.	0.001uF	50V	B	UMK105B102KW-F	K22178829		1-	B	c3
C 1204	CHIP CAP.	4.7uF	6.3V	B	JMK107BJ475MA-T	K22084803		1-	B	a4
C 1205	CHIP CAP.	470pF	50V	B	UMK105B471KW-F	K22178825		1-	B	b4
C 1206	CHIP CAP.	0.0047uF	25V	B	GRM36B472K25PT	K22148830		1-	B	b4
C 1207	CHIP CAP.	0.0056uF	25V	B	GRM155B11E562KA01D	K22148802		1-	B	b4
C 1209	CHIP CAP.	0.001uF	50V	B	UMK105B102KW-F	K22178829		1-	B	b4
C 1210	CHIP CAP.	0.01uF	16V	B	GRM36B103K16PT	K22128804		1-	B	a4
C 1211	CHIP CAP.	0.1uF	10V	B	GRM155B11A104KA01D	K22108802		1-	B	a4
C 1212	CHIP CAP.	0.01uF	16V	B	GRM36B103K16PT	K22128804		1-	B	a4
C 1213	CHIP CAP.	0.1uF	10V	B	GRM155B11A104KA01D	K22108802		1-	B	b4
C 1214	CHIP CAP.	56pF	50V	CH	UMK105CH560JW-F	K22178276		1-	B	b4
C 1215	CHIP CAP.	470pF	50V	B	UMK105B471KW-F	K22178825		1-	B	b5
C 1216	CHIP CAP.	0.0018uF	50V	B	UMK105B182KW-F	K22178832		1-	B	b5
C 1217	CHIP CAP.	7pF	50V	CH	UMK105CH070DW-F	K22178255		1-	B	b3
C 1218	CHIP TA.CAP.	22uF	4V		TESVSP0G226M-8R	K78060047		1-	A	A4
C 1219	CHIP CAP.	0.001uF	50V	B	UMK105B102KW-F	K22178829		1-	A	A4
C 1220	CHIP CAP.	0.001uF	50V	B	UMK105B102KW-F	K22178829		1-	B	c4
C 1226	CHIP CAP.	0.1uF	10V	B	GRM155B11A104KA01D	K22108802		1-	B	b3
C 1227	CHIP CAP.	0.1uF	10V	B	GRM155B11A104KA01D	K22108802		1-	B	a3
C 1228	CHIP CAP.	0.0022uF	50V	B	UMK105B222KW-F	K22178833		1-	B	a3

# Main Unit

## Parts List

REF	DESCRIPTION	VALUE	V/W	TOL.	MFR'S DESIG	VXSTD P/N	VERS.	LOT	SIDE	LAY ADR
C 1229	CHIP CAP.	0.01uF	16V	B	GRM36B103K16PT	K22128804		1-	B	b4
C 1230	CHIP CAP.	0.022uF	16V	B	EMK105B223KW-F	K22128813		1-	B	b4
C 1231	CHIP CAP.	0.0039uF	50V	B	UMK105B392KW-F	K22178836		1-	B	b4
C 1232	CHIP CAP.	0.01uF	16V	B	GRM36B103K16PT	K22128804		1-	B	a4
C 1233	CHIP CAP.	0.1uF	10V	B	GRM155B11A104KA01D	K22108802		1-	B	b4
C 1234	CHIP CAP.	0.001uF	50V	B	UMK105B102KW-F	K22178829		1-	A	C5
C 1235	CHIP TA.CAP.	22uF	4V		TESVSP0G226M-8R	K78060047		1-	A	A4
C 1236	CHIP CAP.	0.001uF	50V	B	UMK105B102KW-F	K22178829		1-	A	A4
C 1237	CHIP CAP.	0.001uF	50V	B	UMK105B102KW-F	K22178829		1-	A	A4
C 1240	CHIP CAP.	0.01uF	16V	B	GRM36B103K16PT	K22128804		1-	B	b4
C 1241	CHIP CAP.	0.01uF	16V	B	GRM36B103K16PT	K22128804		1-	B	a3
C 1242	CHIP CAP.	0.047uF	10V	B	GRM155B11A473KA01D	K22108801		1-	B	a3
C 1243	CHIP CAP.	0.047uF	10V	B	GRM155B11A473KA01D	K22108801		1-	A	C2
C 1244	CHIP CAP.	15pF	50V	CH	GRM1552C1H150JZ01D	K22178216		1-	A	B2
C 1245	CHIP CAP.	15pF	50V	CH	GRM1552C1H150JZ01D	K22178216		1-	A	B2
C 1246	CHIP CAP.	15pF	50V	CH	GRM1552C1H150JZ01D	K22178216		1-	A	C2
C 1247	CHIP CAP.	5pF	50V	CH	UMK105CH050CW-F	K22178253		1-	A	C2
C 1248	CHIP CAP.	6pF	50V	CH	UMK105CH060DW-F	K22178254		1-	A	C2
C 1249	CHIP CAP.	0.01uF	16V	B	GRM36B103K16PT	K22128804		1-	A	C1
C 1250	CHIP CAP.	15pF	50V	CH	GRM1552C1H150JZ01D	K22178216		1-	A	C2
C 1251	CHIP CAP.	10pF	50V	CH	UMK105CH100DW-F	K22178258		1	B	c2
C 1251	CHIP CAP.	9pF	50V	CH	UMK105CH090DW-F	K22178257	AUSTRALIA	2-	B	c2
C 1251	CHIP CAP.	10pF	50V	CH	UMK105CH100DW-F	K22178258	EUROPE	2-	B	c2
C 1251	CHIP CAP.	9pF	50V	CH	UMK105CH090DW-F	K22178257	EXPORT	2-	B	c2
C 1251	CHIP CAP.	9pF	50V	CH	UMK105CH090DW-F	K22178257	USA	2-	B	c2
C 1252	CHIP CAP.	10pF	50V	CH	UMK105CH100DW-F	K22178258		1-	B	c2
C 1253	CHIP TA.CAP.	100uF	4V		TEESVA0G107M8R	K78060051		1-	A	B2
C 1254	CHIP TA.CAP.	100uF	4V		TEESVA0G107M8R	K78060051		1-	A	B2
C 1255	CHIP CAP.	0.001uF	50V	B	UMK105B102KW-F	K22178829		1-	A	B1
C 1256	CHIP CAP.	1uF	6.3V	B	GRM155B30J105KE18D	K22088803		1-	A	C2
C 1257	CHIP CAP.	1uF	6.3V	B	GRM155B30J105KE18D	K22088803		1-	A	C2
C 1259	CHIP CAP.	0.001uF	50V	B	UMK105B102KW-F	K22178829		1-	A	C2
C 1261	CHIP CAP.	0.001uF	50V	B	UMK105B102KW-F	K22178829		1-	A	C2
C 1263	CHIP CAP.	0.1uF	10V	B	GRM155B11A104KA01D	K22108802		1-	A	B4
C 1264	CHIP CAP.	18pF	50V	CH	UMK105CH180JW-F	K22178264		1-	B	c2
C 1266	CHIP CAP.	0.001uF	50V	B	UMK105B102KW-F	K22178829		1-	B	c2
C 1267	CHIP CAP.	56pF	50V	CH	GRM1552C1H560JD01D	K22178230		1	B	c2
C 1267	CHIP CAP.	51pF	50V	CH	GRM1552C1H510JZ01D	K22178229		2-	B	c2
C 1268	CHIP CAP.	0.001uF	50V	B	UMK105B102KW-F	K22178829		1-	B	c3
C 1269	CHIP CAP.	0.001uF	50V	B	UMK105B102KW-F	K22178829		1-	B	c2
C 1270	CHIP CAP.	33pF	50V	CH	UMK105CH330JW-F	K22178270		1	B	c2
C 1270	CHIP CAP.	47pF	50V	CH	UMK105CH470JW-F	K22178274		2-	B	c2
C 1271	CHIP CAP.	0.001uF	50V	B	UMK105B102KW-F	K22178829		1-	B	c2
C 1274	CHIP CAP.	0.001uF	50V	B	UMK105B102KW-F	K22178829		1-	B	c2
C 1275	CHIP CAP.	1uF	6.3V	B	GRM155B30J105KE18D	K22088803		1-	A	C2
C 1276	CHIP CAP.	0.001uF	50V	B	UMK105B102KW-F	K22178829		1-	A	C2
C 1277	CHIP CAP.	0.1uF	10V	B	GRM155B11A104KA01D	K22108802		1-	A	C1
C 1280	CHIP CAP.	0.0068uF	25V	B	GRM155B11E682KA01D	K22148803		1-	A	B4
C 1281	CHIP CAP.	0.001uF	50V	B	UMK105B102KW-F	K22178829		1-	A	B5
C 1282	CHIP CAP.	820pF	50V	B	GRM155B11H821KA01D	K22178808		1-	A	B5
C 1284	CHIP CAP.	5pF	50V	CH	UMK105CH050CW-F	K22178253		1	B	c2
C 1284	CHIP CAP.	7pF	50V	CH	UMK105CH070DW-F	K22178255		2-	B	c2
C 1285	CHIP CAP.	12pF	50V	CH	UMK105CH120JW-F	K22178260		1-	B	c1
C 1287	CHIP CAP.	8pF	50V	CH	UMK105CH080DW-F	K22178256		1-	B	c1
C 1288	CHIP CAP.	27pF	50V	CH	UMK105CH270JW-F	K22178268		1-	B	c2
C 1290	CHIP CAP.	27pF	50V	CH	UMK105CH270JW-F	K22178268		1-	B	b2
C 1292	CHIP CAP.	39pF	50V	CH	UMK105CH390JW-F	K22178272		1-	B	c1
C 1293	CHIP CAP.	15pF	50V	CH	UMK105CH150JW-F	K22178262		1-	B	c1
C 1294	CHIP CAP.	33pF	50V	CH	UMK105CH330JW-F	K22178270		1-	B	c1
C 1296	CHIP CAP.	0.001uF	50V	B	UMK105B102KW-F	K22178829		1-	A	B1
C 1297	CHIP TA.CAP.	22uF	4V		TESVSP0G226M-8R	K78060047		1-	B	b2
C 1298	CHIP CAP.	0.01uF	16V	B	GRM36B103K16PT	K22128804		1-	A	B4
C 1299	CHIP TA.CAP.	33uF	10V		TEMSVB21A336M-8R	K78100047		1-	B	b2
C 1300	CHIP TA.CAP.	10uF	10V		TEESVP1A106M8R	K78100074		1-	B	c4
C 1301	CHIP CAP.	0.1uF	10V	B	GRM155B11A104KA01D	K22108802		1-	B	b2
C 1302	CHIP CAP.	0.001uF	50V	B	UMK105B102KW-F	K22178829		1-	B	b2
C 1303	CHIP CAP.	820pF	50V	B	GRM155B11H821KA01D	K22178808		1-	A	B4
C 1304	CHIP CAP.	0.001uF	50V	B	UMK105B102KW-F	K22178829		1-	A	B5
C 1306	CHIP CAP.	4.7uF	6.3V	B	JMK107BJ475MA-T	K22084803		1-	A	B5
C 1307	CHIP CAP.	0.001uF	50V	B	UMK105B102KW-F	K22178829		1-	A	B2
C 1308	CHIP CAP.	68pF	50V	CH	UMK105CH680JW-F	K22178278		1-	B	c1
C 1309	CHIP CAP.	15pF	50V	CH	UMK105CH150JW-F	K22178262		1-	B	c1
C 1310	CHIP CAP.	18pF	50V	CH	UMK105CH180JW-F	K22178264		1-	B	c1

# Main Unit

## Parts List

REF	DESCRIPTION	VALUE	V/W	TOL.	MFR'S DESIG	VXSTD P/N	VERS.	LOT	SIDE	LAY ADR
C 1311	CHIP CAP.	15pF	50V	CH	UMK105CH150JW-F	K22178262		1-	B	c1
C 1312	CHIP CAP.	7pF	50V	CH	UMK105CH070DW-F	K22178255		1-	B	c1
C 1313	CHIP CAP.	33pF	50V	CH	UMK105CH330JW-F	K22178270		1-	B	c1
C 1314	CHIP CAP.	0.001uF	50V	B	UMK105B102KW-F	K22178829		1-	A	A1
C 1315	CHIP CAP.	8pF	50V	CH	UMK105CH080DW-F	K22178256		1-	B	c1
C 1316	CHIP CAP.	0.001uF	50V	B	UMK105B102KW-F	K22178829		1-	B	b1
C 1318	CHIP CAP.	100pF	50V	CH	GRM1552C1H101JD01D	K22178236		1-	A	A4
C 1319	CHIP CAP.	0.047uF	16V	F	GRM155F11C473ZA01D	K22129004		1-	A	B1
C 1320	CHIP CAP.	0.1uF	10V	B	GRM155B11A104KA01D	K22108802		1-	A	A1
C 1321	CHIP CAP.	0.1uF	10V	B	GRM155B11A104KA01D	K22108802		1-	A	A1
C 1322	CHIP CAP.	680pF	50V	B	UMK105B681KW-F	K22178827		1-	A	A2
C 1323	CHIP CAP.	0.001uF	50V	B	UMK105B102KW-F	K22178829		1-	B	b1
C 1324	CHIP CAP.	0.001uF	50V	B	UMK105B102KW-F	K22178829		1-	B	b1
C 1325	CHIP CAP.	0.001uF	50V	B	UMK105B102KW-F	K22178829		1-	B	a2
C 1326	CHIP CAP.	100pF	50V	CH	GRM1552C1H101JD01D	K22178236		1-	A	A4
C 1327	CHIP CAP.	0.047uF	16V	F	GRM155F11C473ZA01D	K22129004		1-	A	B1
C 1329	CHIP TA.CAP.	22uF	4V		TESVSP0G226M-8R	K78060047		1-	B	a1
C 1330	CHIP CAP.	1uF	6.3V	B	GRM155B30J105KE18D	K22088803		1-	A	A2
C 1331	CHIP CAP.	1uF	6.3V	B	GRM155B30J105KE18D	K22088803		1-	A	A2
C 1332	CHIP CAP.	220pF	50V	B	UMK105B221KW-F	K22178821		1-	B	a4
C 1333	CHIP CAP.	1uF	6.3V	B	GRM155B30J105KE18D	K22088803		1-	A	A2
C 1334	CHIP CAP.	0.001uF	50V	B	UMK105B102KW-F	K22178829		1-	A	A2
C 1335	CHIP CAP.	1uF	6.3V	B	GRM155B30J105KE18D	K22088803		1-	A	B5
C 1336	AL.ELECTRO.CAP.	47uF	10V		RV5-10V470M	K48100011		1-	B	b1
C 1337	AL.ELECTRO.CAP.	47uF	10V		RV5-10V470M	K48100011		1-	B	b1
C 1338	CHIP CAP.	0.1uF	10V	B	GRM155B11A104KA01D	K22108802		1-	A	A4
C 1339	CHIP CAP.	1uF	6.3V	B	GRM155B30J105KE18D	K22088803		1-	A	B4
C 1340	CHIP CAP.	0.33uF	6.3V	B	GRM155B10J334KE18D	K22088801		1-	B	c4
C 1341	CHIP TA.CAP.	22uF	4V		TESVSP0G226M-8R	K78060047		1-	A	A4
C 1342	CHIP CAP.	1uF	6.3V	B	GRM155B30J105KE18D	K22088803		1-	A	C1
C 1346	CHIP CAP.	0.001uF	50V	B	UMK105B102KW-F	K22178829		1-	A	C3
C 1347	CHIP CAP.	0.001uF	50V	B	UMK105B102KW-F	K22178829		1-	B	c2
C 1348	CHIP CAP.	0.01uF	25V	B	GRM155B11E103KA01D	K22148834		1-	A	A1
C 1349	CHIP CAP.	0.01uF	25V	B	GRM155B11E103KA01D	K22148834		1-	A	A1
C 1350	CHIP CAP.	0.01uF	25V	B	GRM155B11E103KA01D	K22148834		1-	A	C1
C 1351	CHIP CAP.	0.01uF	25V	B	GRM155B11E103KA01D	K22148834		1-	A	B1
C 1352	CHIP CAP.	0.01uF	25V	B	GRM155B11E103KA01D	K22148834		1-	A	B1
C 1353	CHIP CAP.	0.01uF	25V	B	GRM155B11E103KA01D	K22148834		1-	A	A2
C 1356	CHIP CAP.	1uF	6.3V	B	GRM188B10J105KA01D	K22084801		1-		
C 1356	CHIP CAP.	1uF	6.3V	B	GRM155B30J105KE18D	K22088803		4-		
C 1357	CHIP CAP.	0.001uF	50V	B	GRM188B11H102KA01D	K22174809		1-		
C 1357	CHIP CAP.	0.001uF	50V	B	UMK105B102KW-F	K22178829		4-		
C 1358	CHIP CAP.	0.1uF	16V	B	GRM188B11C104KA01D	K22124805		1-		
C 1358	CHIP CAP.	0.1uF	10V	B	GRM155B11A104KA01D	K22108802		4-		
C 1360	CHIP CAP.	0.001uF	50V	B	UMK105B102KW-F	K22178829		1-		
CD1001	CERAMIC DISC				CDBLB450KCAY07-B0	H7900930		1-		
CF1001	CERAMIC FILTER				SFECF10M7GA00-R0	H3900577		1-	B	a3
CF1002	CERAMIC FILTER				ELFC450F	H3900552		1-	B	a4
D 1001	DIODE				JDP2S04E(TAPE)	G2071180		1-	A	A1
D 1002	DIODE				1SS362(TE85R.F)	G2070268		1-	B	c2
D 1003	DIODE				1SS362(TE85R.F)	G2070268		1-	B	c2
D 1004	DIODE				UDZS TE-17 5.1B	G2070908		1-	A	A4
D 1005	DIODE				HVC358B TRF-E	G2070590		1-	B	c3
D 1006	DIODE				1SS400G T2R	G2070934		1-	A	B5
D 1007	DIODE				1SV307(TPH3.F)	G2070638		1-	B	c3
D 1007	DIODE				JDP2S04E(TAPE)	G2071180		4-	B	c3
D 1008	DIODE				DAN222M T2L	G2070936		1-	A	A5
D 1009	LED				CL-165HR/YG-D-T	G2070860		1-	A	C1
D 1010	DIODE				HVC358B TRF-E	G2070590		1-	B	c3
D 1011	DIODE				1SV325(TPH3.F)	G2070848		1-	B	b2
D 1012	DIODE				1SV325(TPH3.F)	G2070848		1-	B	b3
D 1013	DIODE				HVC369B TRF-E	G2070872		1-	B	b3
D 1014	DIODE				1SV325(TPH3.F)	G2070848		1-	B	b3
D 1015	DIODE				1SV325(TPH3.F)	G2070848		1-	B	b2
D 1016	DIODE				HVC369B TRF-E	G2070872		1-	B	b2
D 1017	LED				SML-512WWT86	G2071104		1-	A	A4
D 1018	LED				SML-512WWT86	G2071104		1-	A	A3
D 1019	LED				SML-512WWT86	G2071104		1-	A	C3
D 1020	LED				SML-512WWT86	G2071104		1-	A	C3
D 1021	DIODE				1SV331(TPH3.F)	G2071044		1-	A	B3
D 1022	DIODE				1SV331(TPH3.F)	G2071044		1-	A	C4
D 1023	DIODE				HVC358B TRF-E	G2070590		1-	B	b3
D 1024	DIODE				HVC358B TRF-E	G2070590		1-	B	b3

# Main Unit

## Parts List

REF	DESCRIPTION	VALUE	V/W	TOL.	MFR'S DESIG	VXSTD P/N	VERS.	LOT	SIDE	LAY ADR
D 1025	DIODE				1SV325(TPH3.F)	G2070848		1-	B	b2
D 1026	DIODE				1SV325(TPH3.F)	G2070848		1-	B	b2
D 1027	DIODE				1SS400G T2R	G2070934		1-	B	b3
D 1028	LED				SML-512WWT86	G2071104		1-	A	A5
D 1029	DIODE				1SS400G T2R	G2070934		1-	A	B3
D 1030	DIODE				DAP222M T2L	G2070938		1-	B	a3
D 1031	DIODE				1SS400G T2R	G2070934		1-	B	b3
D 1032	DIODE				1SS400G T2R	G2070934		1-	B	b3
D 1033	DIODE				DA221M T2L	G2070940		1-	B	a4
D 1034	DIODE				DAN222M T2L	G2070936		1-	B	a3
D 1035	DIODE				HVC359 TRF-E	G2070708		1-	B	c4
D 1036	DIODE				DAN222M T2L	G2070936		1-	B	a4
D 1037	DIODE				DAN222M T2L	G2070936		1-	B	a4
D 1038	DIODE				DAN222M T2L	G2070936		1-	B	b4
D 1039	DIODE				DAN222M T2L	G2070936		1-	B	c3
D 1040	DIODE				DAN222M T2L	G2070936		1-	B	c3
D 1041	DIODE				DAN222M T2L	G2070936		1-	B	c3
D 1042	DIODE				DA221M T2L	G2070940		1-	B	a3
D 1043	DIODE				DA221M T2L	G2070940		1-	B	a3
D 1044	DIODE				1SS400G T2R	G2070934		1-	A	A4
D 1047	DIODE				DA221M T2L	G2070940		1-	A	C2
D 1048	DIODE				DA221M T2L	G2070940		1-	A	C2
D 1050	DIODE				RLS135 TE-11	G2070128		1-	B	c2
D 1051	DIODE				1SV307(TPH3.F)	G2070638		1-	B	c2
D 1052	DIODE				RLS135 TE-11	G2070128		1-	B	c2
D 1053	DIODE				1SV307(TPH3.F)	G2070638		1-	B	c2
D 1055	DIODE				1SS385(TE85L.F)	G2070880		1-	A	C3
D 1056	LED				WH104S(TAPE)	G2071174		1-	A	C1
D 1061	DIODE				1SV271(TPH3.F)	G2070476		1-	B	c1
D 1063	DIODE				RB751S-40TE61	G2070850		1-	B	b2
D 1065	DIODE				1SV307(TPH3.F)	G2070638		1-	B	c1
D 1066	DIODE				RB521S-30 TE61	G2070642		1-	B	b2
D 1067	DIODE				RSX101VA-30TR	G2070984		1-	B	b2
D 1068	DIODE				1SS400G T2R	G2070934		1-	B	b1
D 1069	DIODE				M1FM3-5063	G2071090		1-	B	b2
D 1070	DIODE				DA221M T2L	G2070940		1-	A	A4
D 1071	DIODE				1SS400G T2R	G2070934		1-	A	A3
D 1072	DIODE				1SS400G T2R	G2070934		1-	A	A3
D 1073	DIODE				RB521S-30 TE61	G2070642		1-	A	B1
D 1074	DIODE				1SS400G T2R	G2070934		1-	B	c3
D 1075	DIODE				JDP2S04E(TAPE)	G2071180		1-	A	A4
D 1076	SURGE ABSORBER				EZAEG3A50AV	Q9000867		1	A	A1
D 1076	SURGE ABSORBER				EZAEG2A50AX	Q9000868		2-	A	A1
D 1077	DIODE				1SS400 TE61	G2070634		1-		
D 1077	DIODE				1SS400G T2R	G2070934		4-		
DS1001	LCD				912-641A-1373(VER A)	G6090181		1-	A	B2
F 1001	CHIP FUSE	0.63A			FCC10 631ABPA	Q0000114		1-	B	b2
FB1001	FERRITE BEADS				BLM15BD102SN1D	L9190133		1-	B	a2
FB1002	FERRITE BEADS				BLM15BD102SN1D	L9190133		1-	B	b2
FB1003	FERRITE BEADS				BLM15BD102SN1D	L9190133		1-	B	a1
FB1004	FERRITE BEADS				BLM15BD102SN1D	L9190133		1-	B	b1
FB1005	FERRITE BEADS				BLM15BD102SN1D	L9190133		1-	B	c1
FB1006	FERRITE BEADS				BLM15BD102SN1D	L9190133		1-	B	b1
FB1007	FERRITE BEADS				BLM15BD102SN1D	L9190133		1-	B	b1
FB1008	FERRITE BEADS				BLM15BD102SN1D	L9190133		1-	B	c1
FB1009	CHIP COIL				BLM21PG300SN1D	L1690840		1-	B	b2
FB1010	CHIP COIL				BLM21PG300SN1D	L1690840		1-	B	a2
J 1001	CONNECTOR				MJC-041-B1Z-3.5T	P1091312		1-	B	a1
J 1002	SHIELD FINGER				1674954-1	S5000255		1-	A	C5
J 1003	SHIELD FINGER				1674954-1	S5000255		1-	A	B5
J 1004	CONNECTOR				MJC-046-C1-3.5-T	P1091309		1-	B	b1
J 1005	CONNECTOR				AXK6F10345YP	P0091378		1-	B	c4
J 1006	CONNECTOR				AXK6F10345YP	P0091378		1-	B	b4
J 1007	CONNECTOR				AXK6F10345YP	P0091378		1-	B	c3
J 1009	CONNECTOR				MJC-051-A1-1-T	P1091311		1-	B	a2
L 1001	M.RFC	0.0082uH			TFL0510-8N2	L1690810		1-	A	A1
L 1002	M.RFC	0.033uH		2%	C1608CB-33NG	L1691038		1-	B	c3
L 1003	M.RFC	0.12uH		2%	C1608CB-R12G	L1691100		1-	A	A1
L 1004	M.RFC	0.68uH			LK1608 R68K-T	L1690416		1-	A	A5
L 1005	M.RFC	0.0082uH			TFL0510-8N2	L1690810		1-	A	A1
L 1006	M.RFC	0.0047uH			TFL0510-4N7	L1690807		1-	A	A1
L 1008	M.RFC	0.0068uH		5%	C1608CB-6N8J	L1691093		1-	B	c3
L 1009	M.RFC	0.01uH		2%	C1608CB-10NG	L1691032		1-	B	c3



# Main Unit

## Parts List

REF	DESCRIPTION	VALUE	V/W	TOL.	MFR'S DESIG	VXSTD P/N	VERS.	LOT	SIDE	LAY ADR
L 1010	M.RFC	0.15uH		2%	C1608CB-R15G	L1691101		1-	B	b2
L 1011	M.RFC	0.056uH		2%	C1608CB-56NG	L1691041		1-	B	b2
L 1012	M.RFC	0.1uH		2%	C1608CB-R10G	L1691045		1-	A	B1
L 1013	M.RFC	0.15uH		2%	C1608CB-R15G	L1691101		1-	B	c3
L 1014	M.RFC	0.18uH		2%	C1608CB-R18G	L1691102		1-	A	A1
L 1015	M.RFC	0.1uH		2%	C1608CB-R10G	L1691045		1-	A	B1
L 1016	M.RFC	4.7uH			LK1608 4R7K-T	L1690688		1-	A	A5
L 1018	M.RFC	0.01uH			TFL0510-10N	L1690811		1-	A	B3
L 1019	M.RFC	0.0068uH			TFL0510-6N8	L1690809		1-	A	B3
L 1020	M.RFC	0.0027uH			C1005C-2N7K	L1691338		1-	A	B3
L 1021	M.RFC	0.01uH		2%	C1608CB-10NG	L1691032		1-	B	c3
L 1022	M.RFC	0.01uH		2%	C1608CB-10NG	L1691032		1-	B	b3
L 1023	M.RFC	0.082uH		2%	C1608CB-82NG	L1691044		1-	B	b2
L 1024	M.RFC	0.082uH		2%	C1608CB-82NG	L1691044		1-	B	b3
L 1026	M.RFC	0.0027uH			C1005C-2N7K	L1691338		1-	A	C4
L 1027	M.RFC	0.01uH		2%	C1608CB-10NG	L1691032		1-	B	b3
L 1028	M.RFC	0.0047uH			TFL0510-4N7	L1690807		1-	A	B3
L 1029	M.RFC	0.082uH		2%	C1608CB-82NG	L1691044		1-	B	b2
L 1030	M.RFC	0.15uH			LK1608 R15K-T	L1690409		1-	B	a3
L 1031	M.RFC	0.39uH			LK1608 R39K-T	L1690413		1-	B	a3
L 1032	M.RFC	0.33uH			LK1608 R33K-T	L1690412		1-	B	a2
L 1033	M.RFC	0.22uH			LK1608 R22K-T	L1690410		1-	B	c4
L 1034	M.RFC	0.47uH			LK1608 R47K-T	L1690414		1-	B	b5
L 1035	M.RFC	1uH			LK1608 1R0K-T	L1690687		1-	B	b4
L 1036	M.RFC	0.22uH			LK1608 R22K-T	L1690410		1-	B	b4
L 1037	M.RFC	33uH			LK1608 330M-T	L1690690		1-	B	c4
L 1038	M.RFC	0.33uH		2%	C1608CB-R33G	L1691106		1-	B	a4
L 1041	M.RFC	0.022uH			TFL0510-22N	L1690815		1-	B	b4
L 1043	M.RFC	0.022uH			TFL0510-22N	L1690815		1-	B	c3
L 1044	M.RFC	0.015uH			TFL0510-15N	L1690813		1-	B	b3
L 1045	M.RFC	10uH		2%	KQ1008TE100G	L1691216		1-	B	b5
L 1046	M.RFC	150uH			FLC32T-151J	L1690229		1-	A	C2
L 1047	COIL				E2 0.28-1.0-4.5T-R	L0022395		1-	B	c2
L 1049	COIL				E2 0.4-1.3-2T-L	L0022580		1-	B	c2
L 1050	M.RFC	4.7uH			LK1608 4R7K-T	L1690688		1-	B	c2
L 1051	COIL				E2 0.28-1.0-4.5T-R	L0022395		1-	B	c2
L 1052	M.RFC	4.7uH			LK1608 4R7K-T	L1690688		1-	B	c2
L 1053	COIL				E2 0.25-1.9-5.5T-R	L0022610		1-	B	c2
L 1054	COIL				E2 0.35-1.4-3.5T-L-B	L0022729		1-	B	c2
L 1055	COIL				E2 0.35-1.4-3.5T-L-B	L0022729		1-	B	c1
L 1056	COIL				E2 0.25-1.9-6.5T-L	L0022401		1-	B	c2
L 1057	COIL				E2 0.25-1.9-6.5T-L	L0022401		1-	B	c2
L 1058	M.RFC	150uH			FLC32P-T-151K	L1690661		1-	B	b2
L 1059	COIL				E2 0.35-1.6-4T-L	L0022456		1-	B	c1
L 1060	COIL				E2 0.35-1.6-4T-L	L0022456		1-	B	c1
L 1061	COIL				E2 0.25-1.9-6.5T-L	L0022401		1-	B	c1
L 1062	COIL				E2 0.25-1.9-6.5T-L	L0022401		1-	B	c1
MC1001	MICROPHONE ELEMENT				OB-22S44-C1033MG	M3290048		1-	A	B3
Q 1001	TRANSISTOR				MT3S36FS(TE85L.F)	G3070377		1-	A	B3
Q 1002	TRANSISTOR				2SC5555ZD-TR	G3355557		1-	B	c3
Q 1003	TRANSISTOR				2SC5555ZD-TR	G3355557		1-	B	b2
Q 1004	TRANSISTOR				DTC144EM T2L	G3070309		1-	A	A5
Q 1005	IC				NJM2151AV(TAPE)	G1094420		1-	A	A2
Q 1006	FET				2SK3541 T2L	G3835417		1-	A	B5
Q 1007	FET				2SK3541 T2L	G3835417		1-	A	B5
Q 1008	FET				2SK3541 T2L	G3835417		1-	A	B4
Q 1009	TRANSISTOR				EMG2 T2R	G3070304		1-	A	C1
Q 1010	IC				NJM3403AV-TE1	G1092215		1-	A	B4
Q 1011	TRANSISTOR				DTA144EM T2L	G3070310		1-	A	A4
Q 1012	TRANSISTOR				MT3S36FS(TE85L.F)	G3070377		1-	A	B3
Q 1013	TRANSISTOR				2SC5555ZD-TR	G3355557		1-	B	c3
Q 1014	IC				LV24100LP-TLM-E	G1094371		1-	A	A5
Q 1015	TRANSISTOR				2SC5555ZD-TR	G3355557		1-	B	b3
Q 1016	FET				2SK3541 T2L	G3835417		1-	A	B5
Q 1017	IC				M62364FP 600D	G1093033		1-	A	C4
Q 1018	TRANSISTOR				MT3S36FS(TE85L.F)	G3070377		1-	A	C3
Q 1019	TRANSISTOR				2SC5555ZD-TR	G3355557		1-	B	b3
Q 1020	TRANSISTOR				2SC5555ZD-TR	G3355557		1-	B	b3
Q 1021	TRANSISTOR				2SC5555ZD-TR	G3355557		1-	B	b3
Q 1023	IC				NJM12904R-TE1	G1093337		1-	A	C5
Q 1025	IC				NJU7007F3-TE1	G1093617		1-	A	C5
Q 1027	TRANSISTOR				DTC143TM-T2L	G3070372		1-	A	A3
Q 1028	TRANSISTOR				DTC143TM-T2L	G3070372		1-	A	C1

# Main Unit

## Parts List

REF	DESCRIPTION	VALUE	V/W	TOL.	MFR'S DESIG	VXSTD P/N	VERS.	LOT	SIDE	LAY ADR
Q 1029	TRANSISTOR				2SC4915-O(TE85L.F)	G3349158O		1-	B	a2
Q 1030	TRANSISTOR				2SC4915-O(TE85L.F)	G3349158O		1-	B	a3
Q 1031	TRANSISTOR				EMG2 T2R	G3070304		1-	B	a3
Q 1032	FET				2SK3541 T2L	G3835417		1-	A	C3
Q 1033	TRANSISTOR				2SC4915-O(TE85L.F)	G3349158O		1-	B	a3
Q 1034	TRANSISTOR				2SC4915-O(TE85L.F)	G3349158O		1-	B	c4
Q 1035	TRANSISTOR				2SC4915-O(TE85L.F)	G3349158O		1-	B	b5
Q 1036	TRANSISTOR				2SC4915-O(TE85L.F)	G3349158O		1-	B	c5
Q 1037	TRANSISTOR				2SC4915-O(TE85L.F)	G3349158O		1-	B	b4
Q 1038	TRANSISTOR				2SC5374-TL	G3353748		1-	B	b4
Q 1039	TRANSISTOR				DTA114TE TL	G3070264		1-	A	A4
Q 1040	TRANSISTOR				DTC144EM T2L	G3070309		1-	A	A4
Q 1041	IC				MB15A01PFV1-G-BND-EFE1	G1092545		1-	B	b4
Q 1042	TRANSISTOR				DTA114TE TL	G3070264		1-	A	C4
Q 1043	TRANSISTOR				DTA114TE TL	G3070264		1-	A	C3
Q 1044	TRANSISTOR				EMB10 T2R	G3070302		1-	A	C4
Q 1045	TRANSISTOR				DTC144EM T2L	G3070309		1-	A	C4
Q 1047	IC				NJM2552V-TE1	G1094382		1-	B	a4
Q 1048	TRANSISTOR				2SC5374-TL	G3353748		1-	B	b4
Q 1049	TRANSISTOR				DTC144EM T2L	G3070309		1-	B	c4
Q 1050	TRANSISTOR				DTC144EM T2L	G3070309		1-	A	C4
Q 1055	TRANSISTOR				2SC5658 T2L Q/R	G3356588		1-	A	A4
Q 1056	TRANSISTOR				2SC5374-TL	G3353748		1-	B	b3
Q 1057	TRANSISTOR				2SA2029 T2L Q/R	G3120298		1-	A	A4
Q 1058	TRANSISTOR				EMB3 T2R	G3070303		1-	A	A4
Q 1059	TRANSISTOR				DTC144EM T2L	G3070309		1-	A	B4
Q 1060	TRANSISTOR				EMB3 T2R	G3070303		1-	A	B4
Q 1061	TRANSISTOR				DTC144EM T2L	G3070309		1-	A	B4
Q 1065	TRANSISTOR				2SC5658 T2L Q/R	G3356588		1-	B	b3
Q 1067	TRANSISTOR				DTC144EM T2L	G3070309		1-	B	b4
Q 1068	FET				2SJ364-P(TX)	G3703648P		1-	B	b4
Q 1069	TRANSISTOR				RN4985(TE85L.F)	G3070333		1-	A	A4
Q 1070	TRANSISTOR				EMG2 T2R	G3070304		1-	A	A4
Q 1071	TRANSISTOR				2SA2029 T2L Q/R	G3120298		1-	A	A4
Q 1072	TRANSISTOR				EMB10 T2R	G3070302		1-	A	B4
Q 1073	TRANSISTOR				2SA2029 T2L Q/R	G3120298		1-	A	A4
Q 1074	TRANSISTOR				EMB3 T2R	G3070303		1-	A	B4
Q 1075	TRANSISTOR				EMG2 T2R	G3070304		1-	A	A4
Q 1077	TRANSISTOR				2SC5374-TL	G3353748		1-	A	C2
Q 1078	TRANSISTOR				2SC5658 T2L Q/R	G3356588		1-	A	C2
Q 1082	FET				2SK3541 T2L	G3835417		1-	A	B4
Q 1083	IC				NJU7747F4-03-TE1	G1094425		1-	A	B1
Q 1084	IC				XC61GN3002HR	G1094470		1-	A	C2
Q 1085	TRANSISTOR				DTC144EM T2L	G3070309		1-	A	C2
Q 1086	IC				TAR5S30(TE85L.F)	G1093570		1-	A	C1
Q 1087	IC				XC61GN3002HR	G1094470		1-	A	C2
Q 1088	TRANSISTOR				2SC5658 T2L Q/R	G3356588		1-	A	B4
Q 1089	TRANSISTOR				DTC144EM T2L	G3070309		1-	A	A1
Q 1090	FET				MCH6305-TL	G3070301		1-	B	b2
Q 1091	IC				XC6371A650PR	G1094017		1-	B	b2
Q 1092	TRANSISTOR				2SA2029 T2L Q/R	G3120298		1-	A	C3
Q 1093	TRANSISTOR				2SC5658 T2L Q/R	G3356588		1-	A	B5
Q 1094	IC				AT24C256B-10TU-1.8	G1094384		1-	A	B2
Q 1095	IC				HD64F2266TF13V(FLASH)	G1093813		1-	A	B2
Q 1096	TRANSISTOR				CPH6102-TL	G3070223		1-	B	b2
Q 1097	IC				MM1438BWLE	G1093814		1-	B	b2
Q 1098	TRANSISTOR				DTC144EM T2L	G3070309		1-	B	b2
Q 1099	TRANSISTOR				EMD2 T2R	G3070312		1-	A	A4
Q 1100	IC				LC75834W	G1093288		1-	A	A1
Q 1102	TRANSISTOR				DTC144EM T2L	G3070309		1-	A	A2
Q 1103	FET				SSM6J25FE(TAPE)	G3070379		1-	A	C1
Q 1104	TRANSISTOR				DTC144EM T2L	G3070309		1-	A	C1
Q 1105	TRANSISTOR				DTC144EM T2L	G3070309		1-	A	A5
R 1001	CHIP RES.	220	1/16W	5%	RMC1/16S 221JTH	J24189017		1-	A	A1
R 1002	CHIP RES.	4.7k	1/16W	5%	RMC1/16S 472JTH	J24189033		1-	B	c2
R 1003	CHIP RES.	3.3k	1/16W	5%	RMC1/16S 332JTH	J24189031		1-	B	c2
R 1004	CHIP RES.	470k	1/16W	5%	RMC1/16S 474JTH	J24189057		1-	A	C2
R 1005	CHIP RES.	1k	1/16W	5%	RMC1/16S 102JTH	J24189025		1-	A	A3
R 1006	CHIP RES.	47k	1/16W	5%	RMC1/16S 473JTH	J24189045		1-	A	B3
R 1007	CHIP RES.	0	1/16W	5%	RMC1/16S JPTH	J24189070		1-	A	B3
R 1008	CHIP RES.	68k	1/16W	5%	RMC1/16S 683JTH	J24189047		1-	B	c3
R 1009	CHIP RES.	220	1/16W	5%	RMC1/16S 221JTH	J24189017		1-	B	c3
R 1010	CHIP RES.	47k	1/16W	5%	RMC1/16S 473JTH	J24189045		1-	B	c3

# Main Unit

## Parts List

REF	DESCRIPTION	VALUE	V/W	TOL.	MFR'S DESIG	VXSTD P/N	VERS.	LOT	SIDE	LAY ADR
R 1011	CHIP RES.	470	1/16W	5%	RMC1/16S 471JTH	J24189021		1-	B	b3
R 1012	CHIP RES.	220	1/16W	5%	RMC1/16S 221JTH	J24189017		1-	B	b3
R 1013	CHIP RES.	100k	1/16W	5%	RMC1/16S 104JTH	J24189049		1-	B	b3
R 1014	CHIP RES.	2.2k	1/16W	5%	RMC1/16S 222JTH	J24189029		1-	A	A5
R 1015	CHIP RES.	1k	1/16W	5%	RMC1/16S 102JTH	J24189025		1-	A	A5
R 1016	CHIP RES.	1k	1/16W	5%	RMC1/16S 102JTH	J24189025		1-	A	A5
R 1017	CHIP RES.	10k	1/16W	5%	RMC1/16S 103JTH	J24189037		1-	A	A5
R 1017	CHIP RES.	2.2k	1/16W	5%	RMC1/16S 222JTH	J24189029		2-	A	A5
R 1018	CHIP RES.	1k	1/16W	5%	RMC1/16S 102JTH	J24189025		1-	A	A5
R 1019	CHIP RES.	47k	1/16W	5%	RMC1/16S 473JTH	J24189045		1-	A	A2
R 1020	CHIP RES.	47k	1/16W	5%	RMC1/16S 473JTH	J24189045		1-	A	A2
R 1021	CHIP RES.	10k	1/16W	5%	RMC1/16S 103JTH	J24189037		1-	A	B5
R 1022	CHIP RES.	39k	1/16W	5%	RMC1/16S 393JTH	J24189044		1-	A	A2
R 1023	CHIP RES.	560	1/16W	5%	RMC1/16S 561JTH	J24189022		1-	A	A2
R 1024	CHIP RES.	10k	1/16W	5%	RMC1/16S 103JTH	J24189037		1-	A	B4
R 1025	CHIP RES.	330k	1/16W	5%	RMC1/16S 334JTH	J24189055		1-	A	B4
R 1026	CHIP RES.	10k	1/16W	5%	RMC1/16S 103JTH	J24189037		1-	A	B4
R 1027	CHIP RES.	10k	1/16W	5%	RMC1/16S 103JTH	J24189037		1-	A	B4
R 1028	CHIP RES.	330k	1/16W	5%	RMC1/16S 334JTH	J24189055		1-	A	B4
R 1029	CHIP RES.	220	1/16W	5%	RMC1/16S 221JTH	J24189017		1-	A	C1
R 1030	CHIP RES.	100	1/16W	5%	RMC1/16S 101JTH	J24189013		1-	A	B1
R 1031	CHIP RES.	330k	1/16W	5%	RMC1/16S 334JTH	J24189055		1-	A	B4
R 1032	CHIP RES.	3.3k	1/16W	5%	RMC1/16S 332JTH	J24189031		1-	A	B4
R 1033	CHIP RES.	5.6k	1/16W	5%	RMC1/16S 562JTH	J24189034		1-	A	B4
R 1034	CHIP RES.	2.2k	1/16W	5%	RMC1/16S 222JTH	J24189029		1-	A	B4
R 1035	CHIP RES.	47k	1/16W	5%	RMC1/16S 473JTH	J24189045		1-	A	B4
R 1036	CHIP RES.	470	1/16W	5%	RMC1/16S 471JTH	J24189021		1-	A	B4
R 1037	CHIP RES.	10k	1/16W	5%	RMC1/16S 103JTH	J24189037		1-	A	B4
R 1039	CHIP RES.	47	1/16W	5%	RMC1/16S 470JTH	J24189009		1-	A	B3
R 1040	CHIP RES.	47k	1/16W	5%	RMC1/16S 473JTH	J24189045		1-	A	B3
R 1041	CHIP RES.	0	1/16W	5%	RMC1/16S JPTH	J24189070		1-	A	B3
R 1042	CHIP RES.	100	1/16W	5%	RMC1/16S 101JTH	J24189013		1-	A	B3
R 1043	CHIP RES.	100k	1/16W	5%	RMC1/16S 104JTH	J24189049		1-	B	c3
R 1044	CHIP RES.	100k	1/16W	5%	RMC1/16S 104JTH	J24189049		1-	B	c3
R 1045	CHIP RES.	47k	1/16W	5%	RMC1/16S 473JTH	J24189045		1-	B	c3
R 1046	CHIP RES.	0	1/16W	5%	RMC1/16S JPTH	J24189070		1-	A	B3
R 1047	CHIP RES.	100	1/16W	5%	RMC1/16S 101JTH	J24189013		1-	B	b3
R 1048	CHIP RES.	100k	1/16W	5%	RMC1/16S 104JTH	J24189049		1-	B	b3
R 1049	CHIP RES.	100k	1/16W	5%	RMC1/16S 104JTH	J24189049		1-	B	b2
R 1050	CHIP RES.	1.5k	1/16W	5%	RMC1/16S 152JTH	J24189027		1-	B	c3
R 1051	CHIP RES.	47k	1/16W	5%	RMC1/16S 473JTH	J24189045		1-	B	b3
R 1052	CHIP RES.	220	1/16W	5%	RMC1/16S 221JTH	J24189017		1-	B	b3
R 1053	CHIP RES.	10k	1/16W	5%	RMC1/16S 103JTH	J24189037		1-	A	B5
R 1054	CHIP RES.	10k	1/16W	5%	RMC1/16S 103JTH	J24189037		1-	A	B5
R 1055	CHIP RES.	330k	1/16W	5%	RMC1/16S 334JTH	J24189055		1-	A	B5
R 1056	CHIP RES.	10k	1/16W	5%	RMC1/16S 103JTH	J24189037		1-	A	B5
R 1057	CHIP RES.	330k	1/16W	5%	RMC1/16S 334JTH	J24189055		1-	A	B5
R 1058	CHIP RES.	10k	1/16W	5%	RMC1/16S 103JTH	J24189037		1-	A	B5
R 1059	CHIP RES.	100k	1/16W	5%	RMC1/16S 104JTH	J24189049		1-	A	C5
R 1060	CHIP RES.	100k	1/16W	5%	RMC1/16S 104JTH	J24189049		1-	A	C5
R 1061	CHIP RES.	10k	1/16W	5%	RMC1/16S 103JTH	J24189037		1-	A	B5
R 1062	CHIP RES.	10k	1/16W	5%	RMC1/16S 103JTH	J24189037		1-	A	B4
R 1063	CHIP RES.	220	1/16W	5%	RMC1/16S 221JTH	J24189017		1-	A	A4
R 1064	CHIP RES.	220	1/16W	5%	RMC1/16S 221JTH	J24189017		1-	A	A3
R 1065	CHIP RES.	180k	1/16W	5%	RMC1/16S 184JTH	J24189052		1-	A	B4
R 1066	CHIP RES.	220	1/16W	5%	RMC1/16S 221JTH	J24189017		1-	A	C3
R 1067	CHIP RES.	220	1/16W	5%	RMC1/16S 221JTH	J24189017		1-	A	C3
R 1068	CHIP RES.	270k	1/16W	5%	RMC1/16S 274JTH	J24189054		1	A	B4
R 1068	CHIP RES.	330k	1/16W	5%	RMC1/16S 334JTH	J24189055		2-	A	B4
R 1069	CHIP RES.	270k	1/16W	5%	RMC1/16S 274JTH	J24189054		1-	A	B4
R 1070	CHIP RES.	100k	1/16W	5%	RMC1/16S 104JTH	J24189049		1-	A	B4
R 1071	CHIP RES.	100k	1/16W	5%	RMC1/16S 104JTH	J24189049		1-	A	B4
R 1072	CHIP RES.	47k	1/16W	5%	RMC1/16S 473JTH	J24189045		1-	A	B4
R 1073	CHIP RES.	47k	1/16W	5%	RMC1/16S 473JTH	J24189045		1-	A	B4
R 1074	CHIP RES.	33k	1/16W	5%	RMC1/16S 333JTH	J24189043		1-	A	B3
R 1075	CHIP RES.	5.6k	1/16W	5%	RMC1/16S 562JTH	J24189034		1-	A	B4
R 1076	CHIP RES.	5.6k	1/16W	5%	RMC1/16S 562JTH	J24189034		1-	A	B4
R 1077	CHIP RES.	100k	1/16W	5%	RMC1/16S 104JTH	J24189049		1-	A	A4
R 1078	CHIP RES.	100k	1/16W	5%	RMC1/16S 104JTH	J24189049		1-	A	B4
R 1079	CHIP RES.	100k	1/16W	5%	RMC1/16S 104JTH	J24189049		1-	A	B4
R 1080	CHIP RES.	100k	1/16W	5%	RMC1/16S 104JTH	J24189049		1-	A	C3
R 1081	CHIP RES.	100k	1/16W	5%	RMC1/16S 104JTH	J24189049		1-	B	b3
R 1082	CHIP RES.	100k	1/16W	5%	RMC1/16S 104JTH	J24189049		1-	B	b3

# Main Unit

## Parts List

REF	DESCRIPTION	VALUE	V/W	TOL.	MFR'S DESIG	VXSTD P/N	VERS.	LOT	SIDE	LAY ADR
R 1083	CHIP RES.	100k	1/16W	5%	RMC1/16S 104JTH	J24189049		1-	B	b3
R 1084	CHIP RES.	47	1/16W	5%	RMC1/16S 470JTH	J24189009		1-	B	b3
R 1085	CHIP RES.	220	1/16W	5%	RMC1/16S 221JTH	J24189017		1-	B	b3
R 1086	CHIP RES.	100k	1/16W	5%	RMC1/16S 104JTH	J24189049		1-	B	b2
R 1087	CHIP RES.	270k	1/16W	5%	RMC1/16S 274JTH	J24189054		1-	B	b3
R 1088	CHIP RES.	100k	1/16W	5%	RMC1/16S 104JTH	J24189049		1-	B	b3
R 1089	CHIP RES.	220k	1/16W	5%	RMC1/16S 224JTH	J24189053		1-	B	b3
R 1090	CHIP RES.	220	1/16W	5%	RMC1/16S 221JTH	J24189017		1	B	b3
R 1090	CHIP RES.	330	1/16W	5%	RMC1/16S 331JTH	J24189019		2-	B	b3
R 1091	CHIP RES.	220	1/16W	5%	RMC1/16S 221JTH	J24189017		1-	B	b2
R 1092	CHIP RES.	330	1/16W	5%	RMC1/16S 331JTH	J24189019		1-	B	b3
R 1093	CHIP RES.	330	1/16W	5%	RMC1/16S 331JTH	J24189019		1-	B	b3
R 1094	CHIP RES.	4.7k	1/16W	5%	RMC1/16S 472JTH	J24189033		1-	A	A4
R 1095	CHIP RES.	2.2k	1/16W	5%	RMC1/16S 222JTH	J24189029		1-	A	A4
R 1096	CHIP RES.	390k	1/16W	0.5%	MCR01MZPD3903	J24189331		1-	A	C5
R 1097	CHIP RES.	470k	1/16W	0.5%	MCR01MZPD4703	J24189332		1-	A	C5
R 1098	CHIP RES.	330k	1/16W	0.5%	MCR01MZPD3303	J24189330		1-	A	C5
R 1099	CHIP RES.	560k	1/16W	0.5%	MCR01MZPD5603	J24189335		1-	A	C5
R 1100	CHIP RES.	270k	1/16W	0.5%	MCR01MZPD2703	J24189329		1-	A	C5
R 1101	CHIP RES.	1M	1/16W	1%	MCR01MZSF1004	J24189333		1-	A	C5
R 1102	CHIP RES.	820k	1/16W	0.5%	MCR01MZPD8203	J24189336		1-	A	C5
R 1103	CHIP RES.	10k	1/16W	5%	RMC1/16S 103JTH	J24189037		1-	A	C5
R 1104	CHIP RES.	47	1/16W	5%	RMC1/16S 470JTH	J24189009		1-	A	C1
R 1105	CHIP RES.	4.7k	1/16W	5%	RMC1/16S 472JTH	J24189033		1-	A	C4
R 1106	CHIP RES.	2.2k	1/16W	5%	RMC1/16S 222JTH	J24189029		1-	A	B4
R 1107	CHIP RES.	4.7k	1/16W	5%	RMC1/16S 472JTH	J24189033		1-	A	B4
R 1108	CHIP RES.	470k	1/16W	5%	RMC1/16S 474JTH	J24189057		1-	A	B4
R 1109	CHIP RES.	470	1/16W	5%	RMC1/16S 471JTH	J24189021		1-	A	C3
R 1110	CHIP RES.	470	1/16W	5%	RMC1/16S 471JTH	J24189021		1-	A	B3
R 1111	CHIP RES.	470	1/16W	5%	RMC1/16S 471JTH	J24189021		1-	B	a3
R 1112	CHIP RES.	470k	1/16W	5%	RMC1/16S 474JTH	J24189057		1-	B	a3
R 1113	CHIP RES.	270k	1/16W	0.5%	MCR01MZPD2703	J24189329		1-	A	B4
R 1114	CHIP RES.	100k	1/16W	0.5%	RR0510R-104-D	J24189167		1-	A	B4
R 1115	CHIP RES.	4.7k	1/16W	5%	RMC1/16S 472JTH	J24189033		1-	A	C4
R 1116	CHIP RES.	10k	1/16W	5%	RMC1/16S 103JTH	J24189037		1-	A	B4
R 1117	CHIP RES.	10k	1/16W	5%	RMC1/16S 103JTH	J24189037		1-	A	C4
R 1118	CHIP RES.	470	1/16W	5%	RMC1/16S 471JTH	J24189021		1-	B	a3
R 1119	CHIP RES.	470	1/16W	5%	RMC1/16S 471JTH	J24189021		1-	B	a3
R 1120	CHIP RES.	100k	1/16W	5%	RMC1/16S 104JTH	J24189049		1-	B	a3
R 1121	CHIP RES.	1k	1/16W	5%	RMC1/16S 102JTH	J24189025		1-	A	C4
R 1123	CHIP RES.	10k	1/16W	5%	RMC1/16S 103JTH	J24189037		1-	A	C4
R 1124	CHIP RES.	100	1/16W	5%	RMC1/16S 101JTH	J24189013		1-	B	a2
R 1125	CHIP RES.	470k	1/16W	5%	RMC1/16S 474JTH	J24189057		1-	B	a3
R 1126	CHIP RES.	150k	1/16W	5%	RMC1/16S 154JTH	J24189051		1-	B	c5
R 1127	CHIP RES.	100k	1/16W	5%	RMC1/16S 104JTH	J24189049		1-	B	b5
R 1128	CHIP RES.	100	1/16W	5%	RMC1/16S 101JTH	J24189013		1-	B	b4
R 1129	CHIP RES.	100	1/16W	5%	RMC1/16S 101JTH	J24189013		1-	B	b5
R 1130	CHIP RES.	560	1/16W	5%	RMC1/16S 561JTH	J24189022		1-	B	c4
R 1131	CHIP RES.	120k	1/16W	5%	RMC1/16S 124JTH	J24189050		1-	B	c4
R 1132	CHIP RES.	330k	1/16W	5%	RMC1/16S 334JTH	J24189055		1-	B	c4
R 1133	CHIP RES.	100	1/16W	5%	RMC1/16S 101JTH	J24189013		1-	B	a4
R 1134	CHIP RES.	1k	1/16W	5%	RMC1/16S 102JTH	J24189025		1-	B	a4
R 1135	CHIP RES.	330	1/16W	5%	RMC1/16S 331JTH	J24189019		1-	B	a2
R 1136	CHIP RES.	1k	1/16W	5%	RMC1/16S 102JTH	J24189025		1-	B	a3
R 1137	CHIP RES.	10k	1/16W	5%	RMC1/16S 103JTH	J24189037		1-	B	b4
R 1138	CHIP RES.	33k	1/16W	5%	RMC1/16S 333JTH	J24189043		1-	B	b3
R 1139	CHIP RES.	1k	1/16W	5%	RMC1/16S 102JTH	J24189025		1-	B	b4
R 1140	CHIP RES.	1k	1/16W	5%	RMC1/16S 102JTH	J24189025		1-	B	b4
R 1141	CHIP RES.	100k	1/16W	5%	RMC1/16S 104JTH	J24189049		1-	B	c4
R 1142	CHIP RES.	3.3k	1/16W	5%	RMC1/16S 332JTH	J24189031		1-	B	c4
R 1143	CHIP RES.	10k	1/16W	5%	RMC1/16S 103JTH	J24189037		1-	B	c4
R 1144	CHIP RES.	680	1/16W	5%	RMC1/16S 681JTH	J24189023		1-	B	c4
R 1145	CHIP RES.	1M	1/16W	5%	RMC1/16S 105JTH	J24189061		1-	B	c4
R 1146	CHIP RES.	100k	1/16W	5%	RMC1/16S 104JTH	J24189049		1-	B	c4
R 1147	CHIP RES.	10k	1/16W	5%	RMC1/16S 103JTH	J24189037		1-	B	b4
R 1148	CHIP RES.	47k	1/16W	5%	RMC1/16S 473JTH	J24189045		1-	B	b4
R 1157	CHIP RES.	1k	1/16W	5%	RMC1/16S 102JTH	J24189025		1-	B	a4
R 1158	CHIP RES.	100k	1/16W	5%	RMC1/16S 104JTH	J24189049		1-	B	a4
R 1159	CHIP RES.	0	1/16W	5%	RMC1/16S JPTH	J24189070		1-	B	a4
R 1160	CHIP RES.	220	1/16W	5%	RMC1/16S 221JTH	J24189017		1-	B	a4
R 1161	CHIP RES.	22k	1/16W	5%	RMC1/16S 223JTH	J24189041		1-	B	a5
R 1162	CHIP RES.	100	1/16W	5%	RMC1/16S 101JTH	J24189013		1-	B	a5
R 1163	CHIP RES.	100	1/16W	5%	RMC1/16S 101JTH	J24189013		1-	B	a5

# Main Unit

## Parts List

REF	DESCRIPTION	VALUE	V/W	TOL.	MFR'S DESIG	VXSTD P/N	VERS.	LOT	SIDE	LAY ADR
R 1164	CHIP RES.	10k	1/16W	5%	RMC1/16S 103JTH	J24189037		1-	B	a5
R 1165	CHIP RES.	10k	1/16W	5%	RMC1/16S 103JTH	J24189037		1-	B	a4
R 1166	CHIP RES.	10k	1/16W	5%	RMC1/16S 103JTH	J24189037		1-	B	a4
R 1167	CHIP RES.	18k	1/16W	5%	RMC1/16S 183JTH	J24189040		1-	B	b3
R 1168	CHIP RES.	1k	1/16W	5%	RMC1/16S 102JTH	J24189025		1-	B	b4
R 1169	CHIP RES.	1.2k	1/16W	5%	RMC1/16S 122JTH	J24189026		1-	B	c4
R 1170	CHIP RES.	1.5k	1/16W	5%	RMC1/16S 152JTH	J24189027		1-	B	c4
R 1171	CHIP RES.	1.8k	1/16W	5%	RMC1/16S 182JTH	J24189028		1-	B	c4
R 1172	CHIP RES.	1k	1/16W	5%	RMC1/16S 102JTH	J24189025		1-	B	c4
R 1173	CHIP RES.	3.3k	1/16W	5%	RMC1/16S 332JTH	J24189031		1-	B	c4
R 1174	CHIP RES.	2.2k	1/16W	5%	RMC1/16S 222JTH	J24189029		1-	B	c4
R 1175	CHIP RES.	1k	1/16W	5%	RMC1/16S 102JTH	J24189025		1-	B	c5
R 1176	CHIP RES.	0	1/16W	5%	RMC1/16S JPTH	J24189070		1-	B	c3
R 1183	CHIP RES.	330k	1/16W	5%	RMC1/16S 334JTH	J24189055		1-	B	b4
R 1184	CHIP RES.	3.3k	1/16W	5%	RMC1/16S 332JTH	J24189031		1-	B	b3
R 1185	CHIP RES.	10k	1/16W	5%	RMC1/16S 103JTH	J24189037		1-	B	b4
R 1186	CHIP RES.	680	1/16W	5%	RMC1/16S 681JTH	J24189023		1-	B	a4
R 1187	CHIP RES.	22k	1/16W	5%	RMC1/16S 223JTH	J24189041		1-	B	a4
R 1188	CHIP RES.	4.7k	1/16W	5%	RMC1/16S 472JTH	J24189033		1-	B	b4
R 1189	CHIP RES.	10k	1/16W	5%	RMC1/16S 103JTH	J24189037		1-	B	a5
R 1190	CHIP RES.	1k	1/16W	5%	RMC1/16S 102JTH	J24189025		1-	B	a4
R 1191	CHIP RES.	220	1/16W	5%	RMC1/16S 221JTH	J24189017		1-	B	b5
R 1192	CHIP RES.	1k	1/16W	5%	RMC1/16S 102JTH	J24189025		1-	A	A4
R 1193	CHIP RES.	10k	1/16W	5%	RMC1/16S 103JTH	J24189037		1-	B	b3
R 1194	CHIP RES.	4.7k	1/16W	5%	RMC1/16S 472JTH	J24189033		1-	A	A4
R 1195	CHIP RES.	100	1/16W	5%	RMC1/16S 101JTH	J24189013		1-	B	c3
R 1202	CHIP RES.	3.3k	1/16W	5%	RMC1/16S 332JTH	J24189031		1-	B	b3
R 1203	CHIP RES.	330k	1/16W	5%	RMC1/16S 334JTH	J24189055		1-	B	b3
R 1204	CHIP RES.	3.3k	1/16W	5%	RMC1/16S 332JTH	J24189031		1-	B	a4
R 1205	CHIP RES.	1k	1/16W	5%	RMC1/16S 102JTH	J24189025		1-	B	a3
R 1206	CHIP RES.	10k	1/16W	5%	RMC1/16S 103JTH	J24189037		1-	B	b4
R 1207	CHIP RES.	330k	1/16W	5%	RMC1/16S 334JTH	J24189055		1-	B	b4
R 1208	CHIP RES.	1k	1/16W	5%	RMC1/16S 102JTH	J24189025		1-	A	A4
R 1209	CHIP RES.	10k	1/16W	5%	RMC1/16S 103JTH	J24189037		1-	A	B4
R 1210	CHIP RES.	1k	1/16W	5%	RMC1/16S 102JTH	J24189025		1-	A	A4
R 1216	CHIP RES.	100k	1/16W	5%	RMC1/16S 104JTH	J24189049		1-	B	a3
R 1217	CHIP RES.	100k	1/16W	5%	RMC1/16S 104JTH	J24189049		1-	B	a3
R 1219	CHIP RES.	330k	1/16W	5%	RMC1/16S 334JTH	J24189055		1-	B	b4
R 1220	CHIP RES.	15k	1/16W	5%	RMC1/16S 153JTH	J24189039		1-	B	b4
R 1221	CHIP RES.	180k	1/16W	5%	RMC1/16S 184JTH	J24189052		1-	B	a3
R 1222	CHIP RES.	100k	1/16W	5%	RMC1/16S 104JTH	J24189049		1-	B	b4
R 1223	CHIP RES.	10k	1/16W	5%	RMC1/16S 103JTH	J24189037		1-	B	b4
R 1224	CHIP RES.	47k	1/16W	5%	RMC1/16S 473JTH	J24189045		1-	A	C3
R 1225	CHIP RES.	100k	1/16W	5%	RMC1/16S 104JTH	J24189049		1-	A	C2
R 1226	CHIP RES.	1M	1/16W	5%	RMC1/16S 105JTH	J24189061		1-	A	C2
R 1227	CHIP RES.	47k	1/16W	5%	RMC1/16S 473JTH	J24189045		1-	A	C2
R 1228	CHIP RES.	330k	1/16W	0.5%	MCR01MZPD3303	J24189330		1-	A	C2
R 1230	CHIP RES.	330k	1/16W	5%	RMC1/16S 334JTH	J24189055		1-	A	C2
R 1231	CHIP RES.	68k	1/16W	0.5%	RR0510R-683-D	J24189163		1-	A	C2
R 1232	CHIP RES.	10k	1/16W	5%	RMC1/16S 103JTH	J24189037		1-	A	B4
R 1234	CHIP RES.	470k	1/16W	5%	RMC1/16S 474JTH	J24189057		1-	A	B4
R 1235	CHIP RES.	220	1/16W	5%	RMC1/16S 221JTH	J24189017		1-	B	c2
R 1236	CHIP RES.	220	1/16W	5%	RMC1/16S 221JTH	J24189017		1-	B	c2
R 1237	CHIP RES.	22k	1/16W	5%	RMC1/16S 223JTH	J24189041		1-	A	C2
R 1238	CHIP RES.	22k	1/16W	5%	RMC1/16S 223JTH	J24189041		1-	A	C2
R 1239	CHIP RES.	2.7k	1/16W	5%	RMC1/16S 272JTH	J24189030		1-	A	B4
R 1240	CHIP RES.	100	1/16W	5%	RMC1/16S 101JTH	J24189013		1-	A	B5
R 1241	CHIP RES.	10k	1/16W	5%	RMC1/16S 103JTH	J24189037		1-	A	B4
R 1242	CHIP RES.	33k	1/16W	5%	RMC1/16S 333JTH	J24189043		1-	A	B5
R 1243	CHIP RES.	150k	1/16W	5%	RMC1/16S 154JTH	J24189051		1-	A	B4
R 1244	CHIP RES.	68k	1/16W	5%	RMC1/16S 683JTH	J24189047		1-	A	C2
R 1245	CHIP RES.	33k	1/16W	5%	RMC1/16S 333JTH	J24189043		1-	A	C2
R 1247	CHIP RES.	22	1/16W	5%	RMC1/16S 220JTH	J24189005		1-	B	b2
R 1248	CHIP RES.	0	1/16W	5%	RMC1/16S JPTH	J24189070		1-	A	C2
R 1249	CHIP RES.	4.7k	1/16W	5%	RMC1/16S 472JTH	J24189033		1-	A	C3
R 1250	CHIP RES.	1.5k	1/16W	5%	RMC1/16S 152JTH	J24189027		1-	A	B5
R 1251	CHIP RES.	2.2M	1/16W	5%	RMC1/16S 225JTH	J24189065		1-	A	B5
R 1252	CHIP RES.	100k	1/16W	5%	RMC1/16S 104JTH	J24189049		1-	A	B5
R 1253	CHIP RES.	470k	1/16W	5%	RMC1/16S 474JTH	J24189057		1-	A	B3
R 1254	CHIP RES.	0	1/16W	5%	RMC1/16S JPTH	J24189070	VER.USA A2	1-		
R 1254	CHIP RES.	0	1/16W	5%	RMC1/16S JPTH	J24189070	VER. A1	1-		
R 1254	CHIP RES.	0	1/16W	5%	RMC1/16S JPTH	J24189070	VER. A2	1-		
R 1254	CHIP RES.	0	1/16W	5%	RMC1/16S JPTH	J24189070	VER. B1	1-		

# Main Unit

## Parts List

REF	DESCRIPTION	VALUE	V/W	TOL.	MFR'S DESIG	VXSTD P/N	VERS.	LOT	SIDE	LAY ADR
R 1254	CHIP RES.	0	1/16W	5%	RMC1/16S JPTH	J24189070	VER. B2	1-		
R 1254	CHIP RES.	0	1/16W	5%	RMC1/16S JPTH	J24189070	VER. C1	1-		
R 1254	CHIP RES.	0	1/16W	5%	RMC1/16S JPTH	J24189070	VER. C2	1-		
R 1254	CHIP RES.	0	1/16W	5%	RMC1/16S JPTH	J24189070	VER. D1	1-		
R 1254	CHIP RES.	0	1/16W	5%	RMC1/16S JPTH	J24189070	VER. D2	1-		
R 1254	CHIP RES.	0	1/16W	5%	RMC1/16S JPTH	J24189070	VER. H1	1-		
R 1254	CHIP RES.	0	1/16W	5%	RMC1/16S JPTH	J24189070	VER. H2	1-		
R 1255	CHIP RES.	100	1/16W	5%	RMC1/16S 101JTH	J24189013		1-	A	A1
R 1256	CHIP RES.	100k	1/16W	5%	RMC1/16S 104JTH	J24189049		1-	B	b2
R 1257	CHIP RES.	0	1/16W	5%	RMC1/16S JPTH	J24189070		1-	B	b2
R 1258	CHIP RES.	150	1/16W	5%	RMC1/16S 151JTH	J24189015		1-	B	b2
R 1259	CHIP RES.	100k	1/16W	5%	RMC1/16S 104JTH	J24189049		1-	B	b2
R 1260	CHIP RES.	4.7	1/16W	5%	RMC1/16S 4R7JTH	J24189066		1-	B	b2
R 1261	CHIP RES.	100	1/16W	5%	RMC1/16S 101JTH	J24189013		1-	A	A4
R 1262	CHIP RES.	22k	1/16W	5%	RMC1/16S 223JTH	J24189041		1-	B	c3
R 1263	CHIP RES.	22k	1/16W	5%	RMC1/16S 223JTH	J24189041		1-	A	A3
R 1264	CHIP RES.	4.7k	1/16W	5%	RMC1/16S 472JTH	J24189033		1-	B	c3
R 1265	CHIP RES.	22k	1/16W	5%	RMC1/16S 223JTH	J24189041		1-	A	B1
R 1266	CHIP RES.	22k	1/16W	5%	RMC1/16S 223JTH	J24189041		1-	A	B1
R 1267	CHIP RES.	47k	1/16W	5%	RMC1/16S 473JTH	J24189045		1-	A	A2
R 1268	CHIP RES.	0.2	1/2W	1%	RLC32-R200FTP	J24279031		1-	A	C2
R 1269	CHIP RES.	100k	1/16W	5%	RMC1/16S 104JTH	J24189049		1-	A	A4
R 1270	CHIP RES.	100k	1/16W	5%	RMC1/16S 104JTH	J24189049		1-	A	B3
R 1271	CHIP RES.	100k	1/16W	5%	RMC1/16S 104JTH	J24189049		1-	A	B3
R 1272	CHIP RES.	100k	1/16W	5%	RMC1/16S 104JTH	J24189049		1-	A	C3
R 1273	CHIP RES.	100k	1/16W	5%	RMC1/16S 104JTH	J24189049		1-	A	C3
R 1275	CHIP RES.	220	1/16W	5%	RMC1/16S 221JTH	J24189017		1-	A	A5
R 1276	CHIP RES.	47	1/16W	5%	RMC1/16S 470JTH	J24189009		1-	B	b4
R 1277	CHIP RES.	100k	1/16W	5%	RMC1/16S 104JTH	J24189049		1-	A	C1
R 1278	CHIP RES.	18k	1/16W	5%	RMC1/16S 183JTH	J24189040		1-	A	B5
R 1279	CHIP RES.	18k	1/16W	5%	RMC1/16S 183JTH	J24189040		1-	A	B5
R 1280	CHIP RES.	680	1/16W	5%	RMC1/16S 681JTH	J24189023		1-	B	c4
R 1281	CHIP RES.	680	1/16W	5%	RMC1/16S 681JTH	J24189023		1-	B	c4
R 1282	CHIP RES.	1k	1/16W	5%	RMC1/16S 102JTH	J24189025		1-		
R 1283	CHIP RES.	0	1/16W	5%	RMC1/16 000JATP	J24185000		1-3		
R 1284	CHIP RES.	0	1/16W	5%	RMC1/16S JPTH	J24189070		1-		
R 1285	CHIP RES.	0	1/16W	5%	RMC1/16S JPTH	J24189070		1-		
R 1286	CHIP RES.	0	1/16W	5%	RMC1/16S JPTH	J24189070		1-		
R 1287	CHIP RES.	3.3k	1/16W	5%	RMC1/16 332JATP	J24185332		1-		
R 1287	CHIP RES.	3.3k	1/16W	5%	RMC1/16S 332JTH	J24189031		4-		
R 1288	CHIP RES.	100	1/16W	5%	RMC1/16 101JATP	J24185101		1-		
R 1288	CHIP RES.	100	1/16W	5%	RMC1/16S 101JTH	J24189013		4-		
R 1289	CHIP RES.	100	1/16W	5%	RMC1/16S 101JTH	J24189013		1-		
S 1001	TACT SWITCH				SKRWAAEE010	N5090156		1-	A	A3
S 1002	TACT SWITCH				SKRWAAEE010	N5090156		1-	A	A3
S 1003	TACT SWITCH				SKRWAAEE010	N5090156		1-	A	A4
S 1004	TACT SWITCH				SKRWAAEE010	N5090156		1-	A	A4
S 1005	TACT SWITCH				SKRWAAEE010	N5090156		1-	A	A5
S 1006	TACT SWITCH				SKRWAAEE010	N5090156		1-	A	B3
S 1007	TACT SWITCH				SKRWAAEE010	N5090156		1-	A	B3
S 1008	TACT SWITCH				SKRWAAEE010	N5090156		1-	A	C3
S 1009	TACT SWITCH				SKRWAAEE010	N5090156		1-	A	C3
S 1010	DETECTION SWITCH				SPPW811203	N4090160		1-	B	b3
S 1011	ROTARY ENCODER				TP70N00E20 RY-8401	Q9000880		1-	B	a1
TH1001	THERMISTOR				ERTJ1VV473J	G9090122		1-	A	C2
X 1001	XTAL XV00117	11.7MHz			11.7MHZ	H0103330A		1-	B	c4
X 1002	XTAL SSP-T7-F	32.768kHz			32.768KHZ	H0103327		1-	A	B2
X 1003	XTAL AT-38	3.579545MHz			3.579545MHZ	H0103292		1-		
XF1001	XTAL FILTER				47S15A 47.25MHZ	H1102411		1-	B	a3

Downloaded by  
RadioAmateur.EU

# Filter Unit

## Circuit Diagram

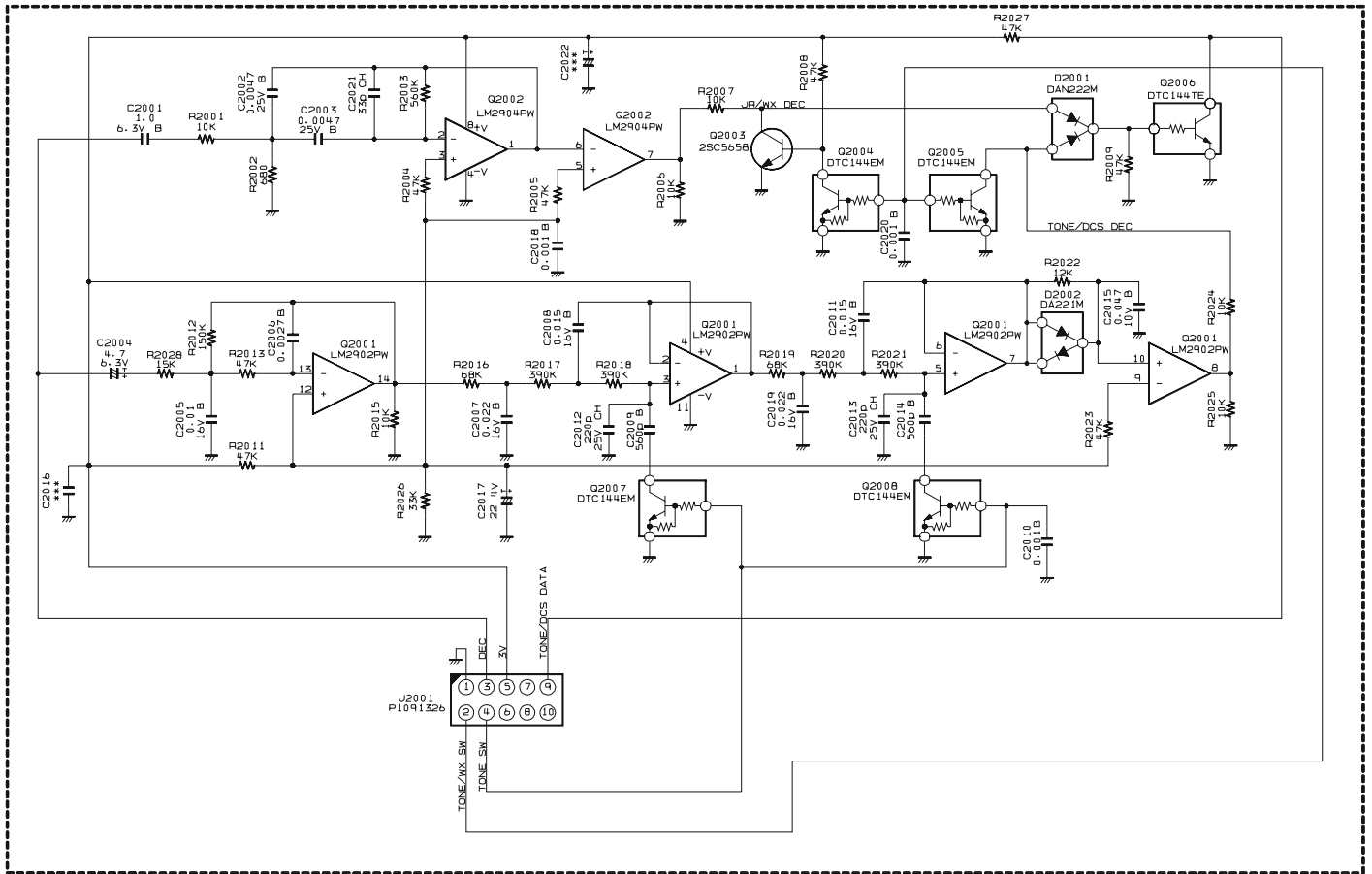

# Filter Unit

## Parts Layout (Side A)

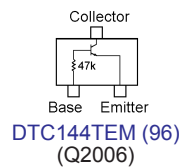
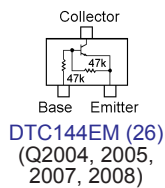
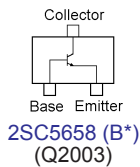
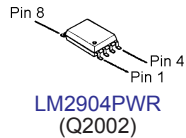
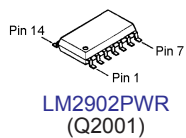
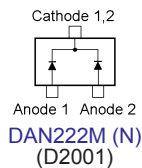
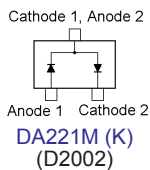
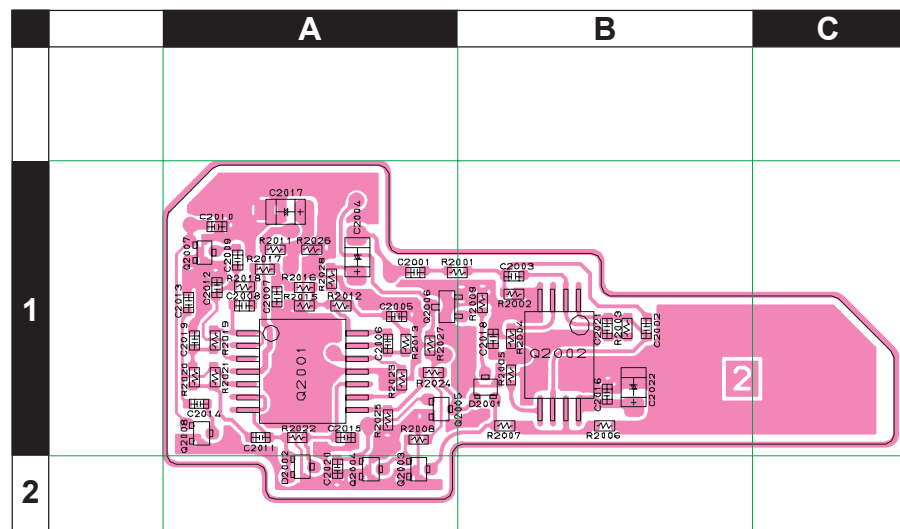

## Parts Layout (Side B)

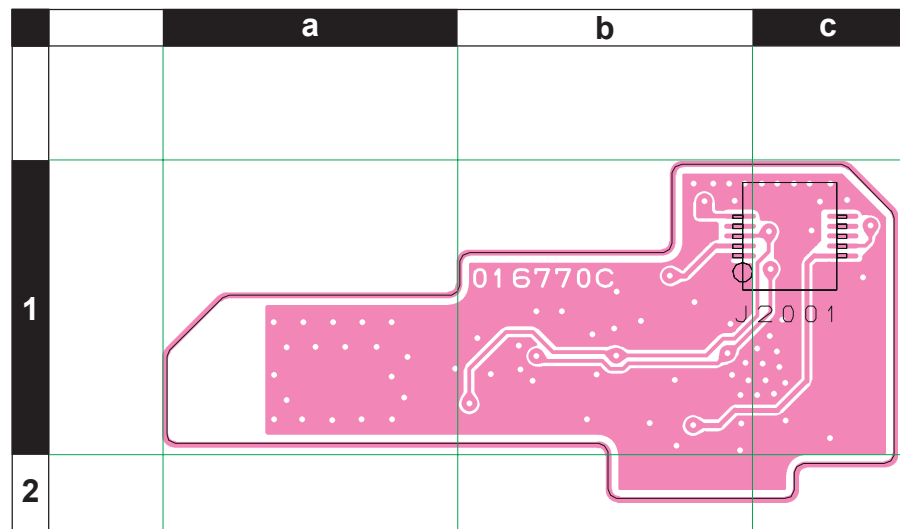



# Filter Unit

## Parts List

REF	DESCRIPTION	VALUE	V/W	TOL.	MFR'S DESIG	VXSTD P/N	VERS.	LOT	SIDE	LAY ADR
P.C.B. with Components						CB4006001				
	Printed Circuit Board					FR0167700		1-		
C 2001	CHIP CAP.	1uF	6.3V	B	GRM155B30J105KE18D	K22088803		1-	A	A1
C 2002	CHIP CAP.	0.0047uF	25V	B	TMK105B472KW-F	K22148831		1-	A	B1
C 2003	CHIP CAP.	0.0047uF	25V	B	TMK105B472KW-F	K22148831		1-	A	B1
C 2004	CHIP TA.CAP.	4.7uF	6.3V		TESVSP0J475M-8R	K78080053		1-	A	A1
C 2005	CHIP CAP.	0.01uF	16V	B	GRM36B103K16PT	K22128804		1-	A	A1
C 2006	CHIP CAP.	0.0027uF	50V	B	UMK105B272KW-F	K22178834		1-	A	A1
C 2007	CHIP CAP.	0.022uF	16V	B	GRM155B11C223KA01D	K22128806		1-	A	A1
C 2008	CHIP CAP.	0.015uF	16V	B	EMK105B153KW-F	K22128811		1-	A	A1
C 2009	CHIP CAP.	560pF	50V	B	UMK105B561KW-F	K22178826		1-	A	A1
C 2010	CHIP CAP.	0.001uF	50V	B	UMK105B102KW-F	K22178829		1-	A	A1
C 2011	CHIP CAP.	0.015uF	16V	B	EMK105B153KW-F	K22128811		1-	A	A1
C 2012	CHIP CAP.	220pF	25V	CH	TMK105CH221JW-F	K22148246		1-	A	A1
C 2013	CHIP CAP.	220pF	25V	CH	TMK105CH221JW-F	K22148246		1-	A	A1
C 2014	CHIP CAP.	560pF	50V	B	UMK105B561KW-F	K22178826		1-	A	A1
C 2015	CHIP CAP.	0.047uF	10V	B	GRM155B11A473KA01D	K22108801		1-	A	A1
C 2017	CHIP TA.CAP.	22uF	4V		TESVSP0G226M-8R	K78060047		1-	A	A1
C 2018	CHIP CAP.	0.001uF	50V	B	UMK105B102KW-F	K22178829		1-	A	B1
C 2019	CHIP CAP.	0.022uF	16V	B	GRM155B11C223KA01D	K22128806		1-	A	A1
C 2020	CHIP CAP.	0.001uF	50V	B	UMK105B102KW-F	K22178829		1-	A	A2
C 2021	CHIP CAP.	33pF	50V	CH	GRM1552C1H330JZ01D	K22178224		1-	A	B1
D 2001	DIODE				DAN222M T2L	G2070936		1-	A	B1
D 2002	DIODE				DA221M T2L	G2070940		1-	A	A2
J 2001	CONNECTOR				AXK5F10347YG	P1091326		1-	B	c1
Q 2001	IC				LM2902PWR	G1094009		1-	A	A1
Q 2002	IC				LM2904PWR	G1094010		1-	A	B1
Q 2003	TRANSISTOR				2SC5658 T2L Q/R	G3356588		1-	A	A2
Q 2004	TRANSISTOR				DTC144EM T2L	G3070309		1-	A	A2
Q 2005	TRANSISTOR				DTC144EM T2L	G3070309		1-	A	A1
Q 2006	TRANSISTOR				DTC144TE-TL	G3070280		1-	A	A1
Q 2007	TRANSISTOR				DTC144EM T2L	G3070309		1-	A	A1
Q 2008	TRANSISTOR				DTC144EM T2L	G3070309		1-	A	A1
R 2001	CHIP RES.	10k	1/16W	5%	RMC1/16S 103JTH	J24189037		1-	A	A1
R 2002	CHIP RES.	680	1/16W	5%	RMC1/16S 681JTH	J24189023		1-	A	B1
R 2003	CHIP RES.	560k	1/16W	5%	RMC1/16S 564JTH	J24189058		1-	A	B1
R 2004	CHIP RES.	47k	1/16W	5%	RMC1/16S 473JTH	J24189045		1-	A	B1
R 2005	CHIP RES.	47k	1/16W	5%	RMC1/16S 473JTH	J24189045		1-	A	B1
R 2006	CHIP RES.	10k	1/16W	5%	RMC1/16S 103JTH	J24189037		1-	A	B1
R 2007	CHIP RES.	10k	1/16W	5%	RMC1/16S 103JTH	J24189037		1-	A	B1
R 2008	CHIP RES.	47k	1/16W	5%	RMC1/16S 473JTH	J24189045		1-	A	A1
R 2009	CHIP RES.	47k	1/16W	5%	RMC1/16S 473JTH	J24189045		1-	A	B1
R 2011	CHIP RES.	47k	1/16W	5%	RMC1/16S 473JTH	J24189045		1-	A	A1
R 2012	CHIP RES.	150k	1/16W	5%	RMC1/16S 154JTH	J24189051		1-	A	A1
R 2013	CHIP RES.	47k	1/16W	5%	RMC1/16S 473JTH	J24189045		1-	A	A1
R 2015	CHIP RES.	10k	1/16W	5%	RMC1/16S 103JTH	J24189037		1-	A	A1
R 2016	CHIP RES.	68k	1/16W	5%	RMC1/16S 683JTH	J24189047		1-	A	A1
R 2017	CHIP RES.	390k	1/16W	5%	RMC1/16S 394JTH	J24189056		1-	A	A1
R 2018	CHIP RES.	390k	1/16W	5%	RMC1/16S 394JTH	J24189056		1-	A	A1
R 2019	CHIP RES.	68k	1/16W	5%	RMC1/16S 683JTH	J24189047		1-	A	A1
R 2020	CHIP RES.	390k	1/16W	5%	RMC1/16S 394JTH	J24189056		1-	A	A1
R 2021	CHIP RES.	390k	1/16W	5%	RMC1/16S 394JTH	J24189056		1-	A	A1
R 2022	CHIP RES.	12k	1/16W	5%	RMC1/16S 123JTH	J24189038		1-	A	A1
R 2023	CHIP RES.	47k	1/16W	5%	RMC1/16S 473JTH	J24189045		1-	A	A1
R 2024	CHIP RES.	10k	1/16W	5%	RMC1/16S 103JTH	J24189037		1-	A	A1
R 2025	CHIP RES.	10k	1/16W	5%	RMC1/16S 103JTH	J24189037		1-	A	A1
R 2026	CHIP RES.	33k	1/16W	5%	RMC1/16S 333JTH	J24189043		1-	A	A1
R 2027	CHIP RES.	47k	1/16W	5%	RMC1/16S 473JTH	J24189045		1-	A	A1
R 2028	CHIP RES.	15k	1/16W	5%	RMC1/16S 153JTH	J24189039		1-	A	A1

## *Filter Unit*

*Note*

# SW Unit Circuit Diagram

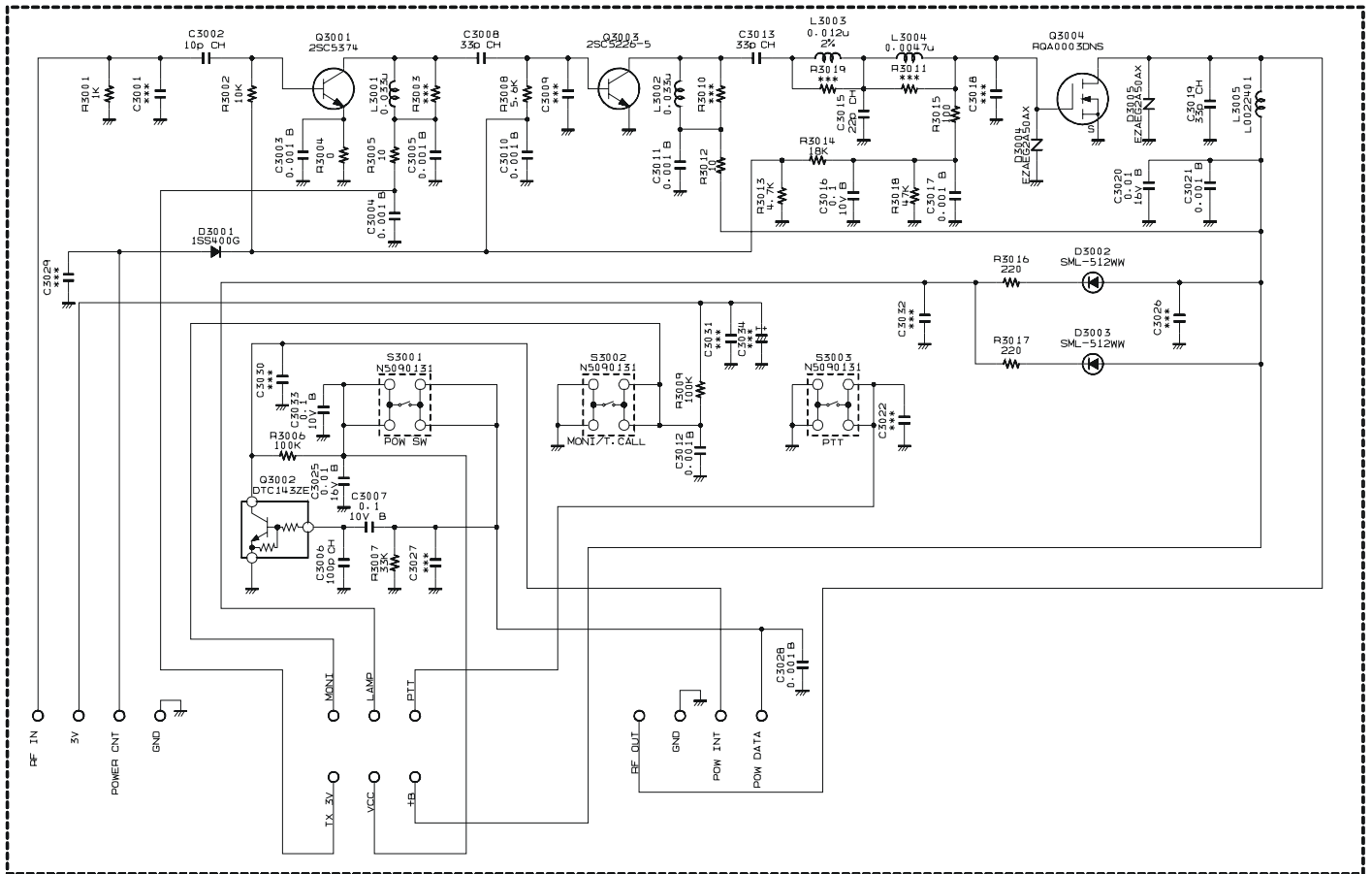

# SW Unit

## Parts Layout (Side A)

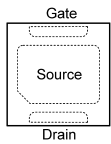
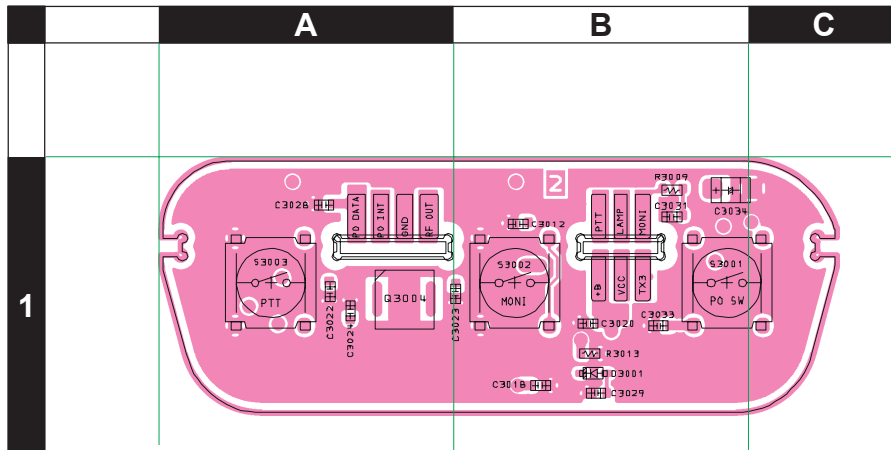

RQA0003DNS  
(Q3004)

## Parts Layout (Side B)

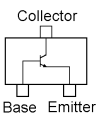
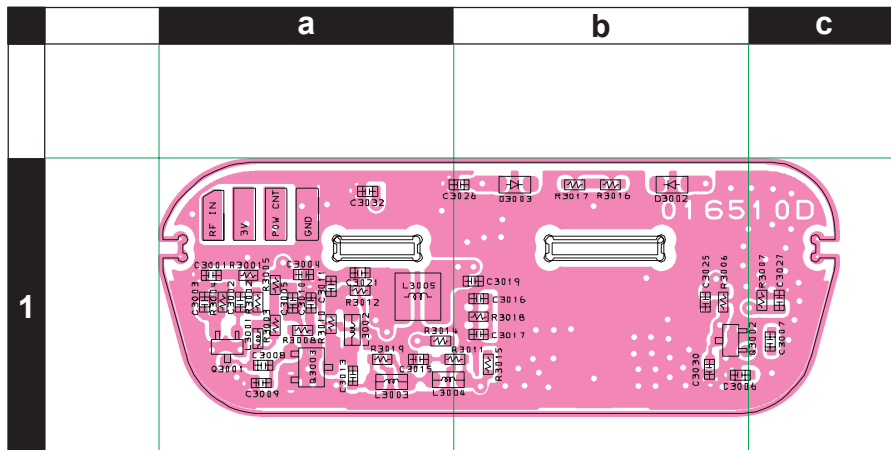

2SC5226 (R22)  
(Q3003)

2SC5374 (NA)  
(Q3001)

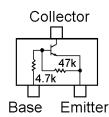

DTC143ZE (E23)  
(Q3003)

REF	DESCRIPTION	VALUE	V/W	TOL.	MFR'S DESIG	VXSTD P/N	VERS.	LOT	SIDE	LAY ADR
P.C.B. with Components						CS1944003	DST:USA			
						CS1944004	DST:EXP			
						CS1944005	DST:EU			
						CS1944006	DST:AUS			
	Printed Circuit Board					FR0165100		1-		
C 3002	CHIP CAP.	10pF	50V	CH	UMK105CH100DW-F	K22178258		1-	B	a1
C 3003	CHIP CAP.	0.001uF	50V	B	UMK105B102KW-F	K22178829		1-	B	a1
C 3004	CHIP CAP.	0.001uF	50V	B	UMK105B102KW-F	K22178829		1-	B	a1
C 3005	CHIP CAP.	0.001uF	50V	B	UMK105B102KW-F	K22178829		1-	B	a1
C 3006	CHIP CAP.	100pF	50V	CH	UMK105CH101JW-F	K22178282		1-	B	b1
C 3007	CHIP CAP.	0.1uF	10V	B	GRM155B11A104KA01D	K22108802		1-	B	c1
C 3008	CHIP CAP.	33pF	50V	CH	UMK105CH330JW-F	K22178270		1-	B	a1
C 3010	CHIP CAP.	0.001uF	50V	B	UMK105B102KW-F	K22178829		1-	B	a1
C 3011	CHIP CAP.	0.001uF	50V	B	UMK105B102KW-F	K22178829		1-	B	a1
C 3012	CHIP CAP.	0.001uF	50V	B	UMK105B102KW-F	K22178829		1-	A	B1
C 3013	CHIP CAP.	39pF	50V	CH	UMK105CH390JW-F	K22178272		1-	B	a1
C 3015	CHIP CAP.	22pF	50V	CH	GRM1552C1H220JZ01D	K22178220		1-	B	a1
C 3016	CHIP CAP.	0.1uF	10V	B	GRM155B11A104KA01D	K22108802		1-	B	b1
C 3017	CHIP CAP.	0.001uF	50V	B	UMK105B102KW-F	K22178829		1-	B	b1
C 3019	CHIP CAP.	33pF	50V	CH	UMK105CH330JW-F	K22178270		1-	B	b1
C 3020	CHIP CAP.	0.01uF	16V	B	GRM36B103K16PT	K22128804		1-	A	B1
C 3021	CHIP CAP.	0.001uF	50V	B	UMK105B102KW-F	K22178829		1-	B	a1
C 3025	CHIP CAP.	0.01uF	16V	B	GRM36B103K16PT	K22128804		1-	B	b1
C 3028	CHIP CAP.	0.001uF	50V	B	UMK105B102KW-F	K22178829		1-	A	A1
C 3033	CHIP CAP.	0.1uF	10V	B	GRM155B11A104KA01D	K22108802		1-	A	B1
D 3001	DIODE				1SS400G T2R	G2070934		1-	A	B1
D 3002	LED				SML-512WWT86	G2071104		1-	B	b1
D 3003	LED				SML-512WWT86	G2071104		1-	B	b1
D 3004	SURGE ABSORBER				EZAEG2A50AX	Q9000868		1-3		
D 3005	SURGE ABSORBER				EZAEG2A50AX	Q9000868		1-3		
D 3006	SURGE ABSORBER				TVSF0603	Q9000847		1-		
D 3007	SURGE ABSORBER				TVSF0603	Q9000847		1-		
D 3008	DIODE				UDZS TE-17 8.2B	G2070890		1-		
D 3008	DIODE				EDZ TE-61 8.2B	G2071188		4-		
L 3001	M.RFC	0.033uH			TFL0510-33N	L1690817		1-	B	a1
L 3002	M.RFC	0.033uH			ELJ-RE33NJF2	L1690720		1-	B	a1
L 3003	CHIP COIL	0.012uH		2%	LQW18AN12NG00D	L1690881		1-	B	a1
L 3004	M.RFC	0.0047uH			ELJ-RE4N7JF2	L1690710		1-	B	a1
L 3005	COIL				E2 0.25-1.9-6.5T-L	L0022401		1-	B	a1
Q 3001	TRANSISTOR				2SC5374-TL	G3353748		1-	B	a1
Q 3002	TRANSISTOR				DTC143ZE TL	G3070102		1-	B	b1
Q 3003	TRANSISTOR				2SC5226-5-TL	G3352268E		1-	B	a1
Q 3004	FET				RQA0003DNS	G3070363		1-	A	A1
R 3001	CHIP RES.	1k	1/16W	5%	RMC1/16S 102JTH	J24189025		1-	B	a1
R 3002	CHIP RES.	10k	1/16W	5%	RMC1/16S 103JTH	J24189037		1-	B	a1
R 3004	CHIP RES.	0	1/16W	5%	RMC1/16S JPTH	J24189070		1-	B	a1
R 3005	CHIP RES.	10	1/16W	5%	RMC1/16S 100JTH	J24189001		1-	B	a1
R 3006	CHIP RES.	100k	1/16W	5%	RMC1/16S 104JTH	J24189049		1-	B	b1
R 3007	CHIP RES.	33k	1/16W	5%	RMC1/16S 333JTH	J24189043		1-	B	c1
R 3008	CHIP RES.	5.6k	1/16W	5%	RMC1/16S 562JTH	J24189034		1-	B	a1
R 3009	CHIP RES.	100k	1/16W	5%	RMC1/16S 104JTH	J24189049		1-	A	B1
R 3012	CHIP RES.	10	1/16W	5%	RMC1/16S 100JTH	J24189001		1-	B	a1
R 3013	CHIP RES.	4.7k	1/16W	5%	RMC1/16S 472JTH	J24189033		1-	A	B1
R 3014	CHIP RES.	15k	1/16W	5%	RMC1/16S 153JTH	J24189039		1-	B	a1
R 3015	CHIP RES.	100	1/16W	5%	RMC1/16S 101JTH	J24189013		1-	B	b1
R 3016	CHIP RES.	220	1/16W	5%	RMC1/16S 221JTH	J24189017		1-	B	b1
R 3017	CHIP RES.	220	1/16W	5%	RMC1/16S 221JTH	J24189017		1-	B	b1
R 3018	CHIP RES.	47k	1/16W	5%	RMC1/16S 473JTH	J24189045		1-	B	b1
S 3001	TACT SWITCH				SOT-152HST	N5090131		1-	A	B1
S 3002	TACT SWITCH				SOT-152HST	N5090131		1-	A	B1
S 3003	TACT SWITCH				SOT-152HST	N5090131		1-	A	A1
TH3001	THERMISTOR				TN05-3M154J	G9090171		1-		

# *SW Unit*

## *Note*

# VCO Unit

## Circuit Diagram

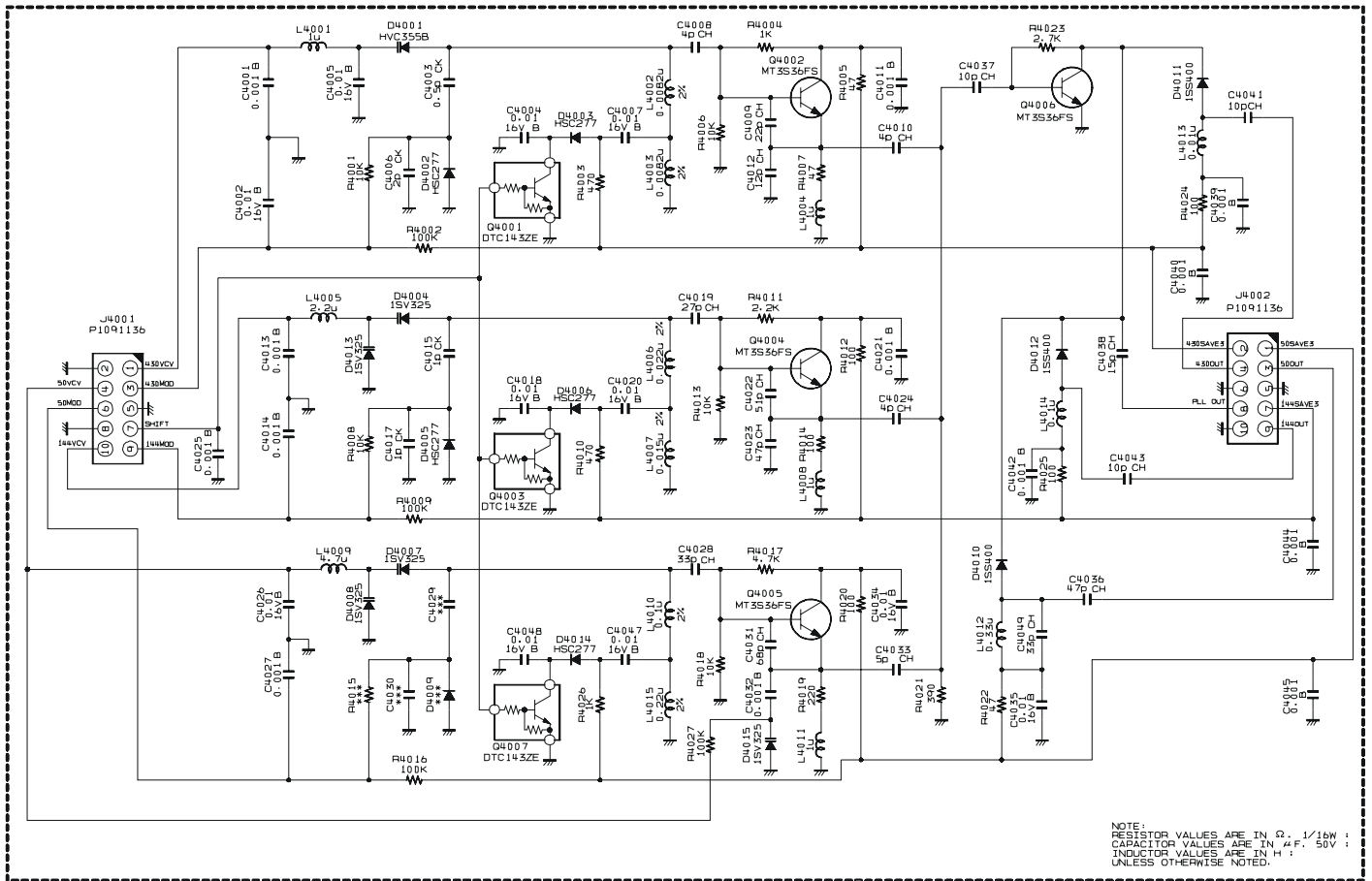

Downloaded by  
RadioAmateur.EU

# VCO Unit

## Parts Layout (Side A)

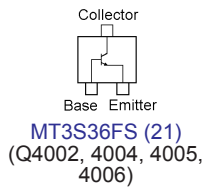
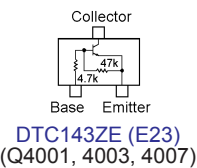
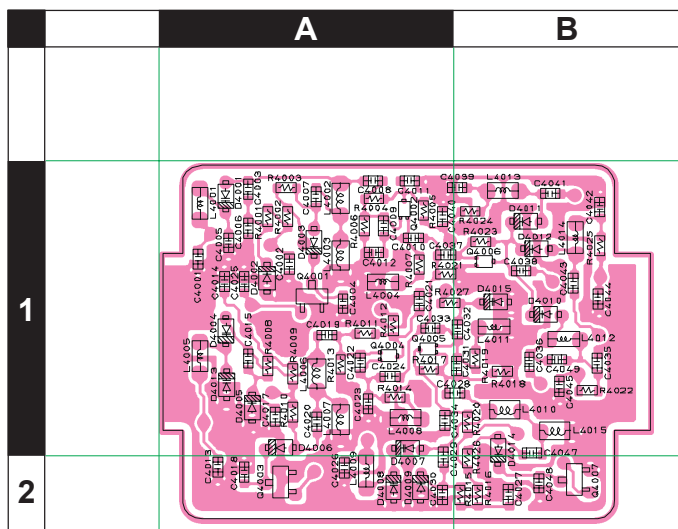

## Parts Layout (Side B)

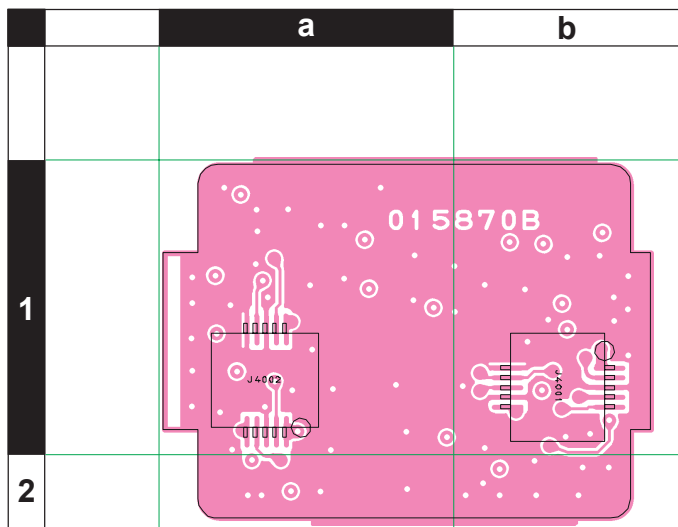



REF	DESCRIPTION	VALUE	V/W	TOL.	MFR'S DESIG	VXSTD P/N	VERS.	LOT	SIDE	LAY ADR
P.C.B. with Components						CB3815001				
	Printed Circuit Board					FR0158700		1-		
C 4001	CHIP CAP.	0.001uF	50V	B	UMK105B102KW-F	K22178829		1-	A	A1
C 4002	CHIP CAP.	0.01uF	16V	B	GRM36B103K16PT	K22128804		1-	A	A1
C 4003	CHIP CAP.	0.5pF	50V	CK	GRM1554C1HR50BZ01D	K22178285		1-	A	A1
C 4004	CHIP CAP.	0.01uF	16V	B	GRM36B103K16PT	K22128804		1-	A	A1
C 4005	CHIP CAP.	0.01uF	16V	B	GRM36B103K16PT	K22128804		1-	A	A1
C 4006	CHIP CAP.	2pF	50V	CK	GRM1554C1H2R0BZ01D	K22178289		1-	A	A1
C 4007	CHIP CAP.	0.01uF	16V	B	GRM36B103K16PT	K22128804		1-	A	A1
C 4008	CHIP CAP.	4pF	50V	CH	GRM1552C1H4R0BZ01D	K22178291		1-	A	A1
C 4009	CHIP CAP.	22pF	50V	CH	GRM1552C1H220GZ01D	K22179707		1-	A	A1
C 4010	CHIP CAP.	4pF	50V	CH	UMK105CH040CW-F	K22178252		1-	A	A1
C 4011	CHIP CAP.	0.001uF	50V	B	UMK105B102KW-F	K22178829		1-	A	A1
C 4012	CHIP CAP.	12pF	50V	CH	GRM1552C1H120JZ01D	K22178214		1-	A	A1
C 4013	CHIP CAP.	0.001uF	50V	B	UMK105B102KW-F	K22178829		1-	A	A2
C 4014	CHIP CAP.	0.001uF	50V	B	UMK105B102KW-F	K22178829		1-	A	A1
C 4015	CHIP CAP.	1pF	50V	CK	GRM1554C1H1R0BZ01D	K22178287		1-	A	A1
C 4017	CHIP CAP.	1pF	50V	CK	GRM1554C1H1R0BZ01D	K22178287		1-	A	A1
C 4018	CHIP CAP.	0.01uF	16V	B	GRM36B103K16PT	K22128804		1-	A	A2
C 4019	CHIP CAP.	27pF	50V	CH	GRM1552C1H270JZ01D	K22178222		1-	A	A1
C 4020	CHIP CAP.	0.01uF	16V	B	GRM36B103K16PT	K22128804		1-	A	A1
C 4021	CHIP CAP.	0.001uF	50V	B	UMK105B102KW-F	K22178829		1-	A	A1
C 4022	CHIP CAP.	51pF	50V	CH	GRM1552C1H510GZ01D	K22179710		1-	A	A1
C 4023	CHIP CAP.	47pF	50V	CH	GRM1552C1H470GZ01D	K22179709		1-	A	A1
C 4024	CHIP CAP.	4pF	50V	CH	UMK105CH040CW-F	K22178252		1-	A	A1
C 4025	CHIP CAP.	0.001uF	50V	B	UMK105B102KW-F	K22178829		1-	A	A1
C 4026	CHIP CAP.	0.01uF	16V	B	GRM36B103K16PT	K22128804		1-	A	A2
C 4027	CHIP CAP.	0.001uF	50V	B	UMK105B102KW-F	K22178829		1-	A	B2
C 4028	CHIP CAP.	33pF	50V	CH	UMK105CH330JW-F	K22178270		1-	A	A1
C 4031	CHIP CAP.	68pF	50V	CH	UMK105CH680JW-F	K22178278		1-	A	A1
C 4032	CHIP CAP.	0.001uF	50V	B	UMK105B102KW-F	K22178829		1-	A	A1
C 4033	CHIP CAP.	5pF	50V	CH	UMK105CH050CW-F	K22178253		1-	A	A1
C 4034	CHIP CAP.	0.01uF	16V	B	GRM36B103K16PT	K22128804		1-	A	A1
C 4035	CHIP CAP.	0.01uF	16V	B	GRM36B103K16PT	K22128804		1-	A	B1
C 4036	CHIP CAP.	47pF	50V	CH	UMK105CH470JW-F	K22178274		1-	A	B1
C 4037	CHIP CAP.	10pF	50V	CH	UMK105CH100DW-F	K22178258		1-	A	A1
C 4038	CHIP CAP.	15pF	50V	CH	UMK105CH150JW-F	K22178262		1-	A	B1
C 4039	CHIP CAP.	0.001uF	50V	B	UMK105B102KW-F	K22178829		1-	A	A1
C 4040	CHIP CAP.	0.001uF	50V	B	UMK105B102KW-F	K22178829		1-	A	A1
C 4041	CHIP CAP.	10pF	50V	CH	UMK105CH100DW-F	K22178258		1-	A	B1
C 4042	CHIP CAP.	0.001uF	50V	B	UMK105B102KW-F	K22178829		1-	A	B1
C 4043	CHIP CAP.	10pF	50V	CH	UMK105CH100DW-F	K22178258		1-	A	B1
C 4044	CHIP CAP.	0.001uF	50V	B	UMK105B102KW-F	K22178829		1-	A	B1
C 4045	CHIP CAP.	0.001uF	50V	B	UMK105B102KW-F	K22178829		1-	A	B1
C 4047	CHIP CAP.	0.01uF	16V	B	GRM36B103K16PT	K22128804		1-	A	B1
C 4048	CHIP CAP.	0.01uF	16V	B	GRM36B103K16PT	K22128804		1-	A	B2
C 4049	CHIP CAP.	33pF	50V	CH	UMK105CH330JW-F	K22178270		1-	A	B1
D 4001	DIODE				HVC355B TRF-E	G2070588		1-	A	A1
D 4002	DIODE				HSC277TRF-E	G2070584		1-	A	A1
D 4003	DIODE				HSC277TRF-E	G2070584		1-	A	A1
D 4004	DIODE				1SV325(TPH3.F)	G2070848		1-	A	A1
D 4005	DIODE				HSC277TRF-E	G2070584		1-	A	A1
D 4006	DIODE				HSC277TRF-E	G2070584		1-	A	A1
D 4007	DIODE				1SV325(TPH3.F)	G2070848		1-	A	A1
D 4008	DIODE				1SV325(TPH3.F)	G2070848		1-	A	A2
D 4010	DIODE				1SS400 TE61	G2070634		1-	A	B1
D 4011	DIODE				1SS400 TE61	G2070634		1-	A	B1
D 4012	DIODE				1SS400 TE61	G2070634		1-	A	B1
D 4013	DIODE				1SV325(TPH3.F)	G2070848		1-	A	A1
D 4014	DIODE				HSC277TRF-E	G2070584		1-	A	B1
D 4015	DIODE				1SV325(TPH3.F)	G2070848		1-	A	B1
J 4001	CONNECTOR				AXK5F10335YP	P1091136		1-	B	b1
J 4002	CONNECTOR				AXK5F10335YP	P1091136		1-	B	a1
L 4001	M.RFC	1uH			LK1608 1R0K-T	L1690687		1-	A	A1
L 4002	M.RFC	0.0082uH		2%	C1608CB-8N2G	L1691226		1-	A	A1
L 4003	M.RFC	0.0082uH		2%	C1608CB-8N2G	L1691226		1-	A	A1
L 4004	M.RFC	1uH			LK1608 1R0K-T	L1690687		1-	A	A1
L 4005	M.RFC	2.2uH			LK1608 2R2K-T	L1690634		1-	A	A1
L 4006	CHIP COIL	0.022uH		2%	LQW18AN22NG00D	L1690884		1-	A	A1
L 4007	M.RFC	0.015uH		2%	C1608CB-15NG	L1691034		1-	A	A1
L 4008	M.RFC	1uH			LK1608 1R0K-T	L1690687		1-	A	A1
L 4009	M.RFC	4.7uH			LK1608 4R7K-T	L1690688		1-	A	A2
L 4010	M.RFC	0.1uH		2%	C1608CB-R10G	L1691045		1-	A	B1

# VCO Unit

## Parts List

REF	DESCRIPTION	VALUE	V/W	TOL.	MFR'S DESIG	VXSTD P/N	VERS.	LOT	SIDE	LAY ADR
L 4011	M.RFC	1uH			LK1608 1R0K-T	L1690687		1-	A	B1
L 4012	M.RFC	0.33uH			LK1608 R33K-T	L1690412		1-	A	B1
L 4013	M.RFC	0.01uH			HK1608 10NJ-T	L1690516		1-	A	B1
L 4014	M.RFC	0.1uH			LK1608 R10K-T	L1690407		1-	A	B1
L 4015	M.RFC	0.22uH		2%	C1608CB-R22G	L1691103		1-	A	B1
Q 4001	TRANSISTOR				DTC143ZE TL	G3070102		1-	A	A1
Q 4002	TRANSISTOR				MT3S36FS(TE85L.F)	G3070377		1-	A	A1
Q 4003	TRANSISTOR				DTC143ZE TL	G3070102		1-	A	A2
Q 4004	TRANSISTOR				MT3S36FS(TE85L.F)	G3070377		1-	A	A1
Q 4005	TRANSISTOR				MT3S36FS(TE85L.F)	G3070377		1-	A	A1
Q 4006	TRANSISTOR				MT3S36FS(TE85L.F)	G3070377		1-	A	B1
Q 4007	TRANSISTOR				DTC143ZE TL	G3070102		1-	A	B2
R 4001	CHIP RES.	10k	1/16W	5%	RMC1/16S 103JTH	J24189037		1-	A	A1
R 4002	CHIP RES.	100k	1/16W	5%	RMC1/16S 104JTH	J24189049		1-	A	A1
R 4003	CHIP RES.	470	1/16W	5%	RMC1/16S 471JTH	J24189021		1-	A	A1
R 4004	CHIP RES.	1k	1/16W	5%	RMC1/16S 102JTH	J24189025		1-	A	A1
R 4005	CHIP RES.	47	1/16W	5%	RMC1/16S 470JTH	J24189009		1-	A	A1
R 4006	CHIP RES.	10k	1/16W	5%	RMC1/16S 103JTH	J24189037		1-	A	A1
R 4007	CHIP RES.	47	1/16W	5%	RMC1/16S 470JTH	J24189009		1-	A	A1
R 4008	CHIP RES.	10k	1/16W	5%	RMC1/16S 103JTH	J24189037		1-	A	A1
R 4009	CHIP RES.	100k	1/16W	5%	RMC1/16S 104JTH	J24189049		1-	A	A1
R 4010	CHIP RES.	470	1/16W	5%	RMC1/16S 471JTH	J24189021		1-	A	A1
R 4011	CHIP RES.	2.2k	1/16W	5%	RMC1/16S 222JTH	J24189029		1-	A	A1
R 4012	CHIP RES.	100	1/16W	5%	RMC1/16S 101JTH	J24189013		1-	A	A1
R 4013	CHIP RES.	10k	1/16W	5%	RMC1/16S 103JTH	J24189037		1-	A	A1
R 4014	CHIP RES.	100	1/16W	5%	RMC1/16S 101JTH	J24189013		1-	A	A1
R 4016	CHIP RES.	100k	1/16W	5%	RMC1/16S 104JTH	J24189049		1-	A	B2
R 4017	CHIP RES.	4.7k	1/16W	5%	RMC1/16S 472JTH	J24189033		1-	A	A1
R 4018	CHIP RES.	10k	1/16W	5%	RMC1/16S 103JTH	J24189037		1-	A	B1
R 4019	CHIP RES.	220	1/16W	5%	RMC1/16S 221JTH	J24189017		1-	A	A1
R 4020	CHIP RES.	100	1/16W	5%	RMC1/16S 101JTH	J24189013		1-	A	A1
R 4021	CHIP RES.	390	1/16W	5%	RMC1/16S 391JTH	J24189020		1-	A	A1
R 4022	CHIP RES.	47	1/16W	5%	RMC1/16S 470JTH	J24189009		1-	A	B1
R 4023	CHIP RES.	2.7k	1/16W	5%	RMC1/16S 272JTH	J24189030		1-	A	B1
R 4024	CHIP RES.	100	1/16W	5%	RMC1/16S 101JTH	J24189013		1-	A	A1
R 4025	CHIP RES.	100	1/16W	5%	RMC1/16S 101JTH	J24189013		1-	A	B1
R 4026	CHIP RES.	1k	1/16W	5%	RMC1/16S 102JTH	J24189025		1-	A	A1
R 4027	CHIP RES.	100k	1/16W	5%	RMC1/16S 104JTH	J24189049		1-	A	A1
	SHIELD CASE VCO					RA0400300		1-		
	STICK FINGER				97-542-02(1/80)	S5000211		1-		





Copyright 2007  
VERTEX STANDARD CO., LTD.  
All rights reserved

No portion of this manual  
may be reproduced without  
the permission of  
VERTEX STANDARD CO., LTD.

**Downloaded by  
RadioAmateur.EU**