

# WiFi AI Camera

— User Manual —

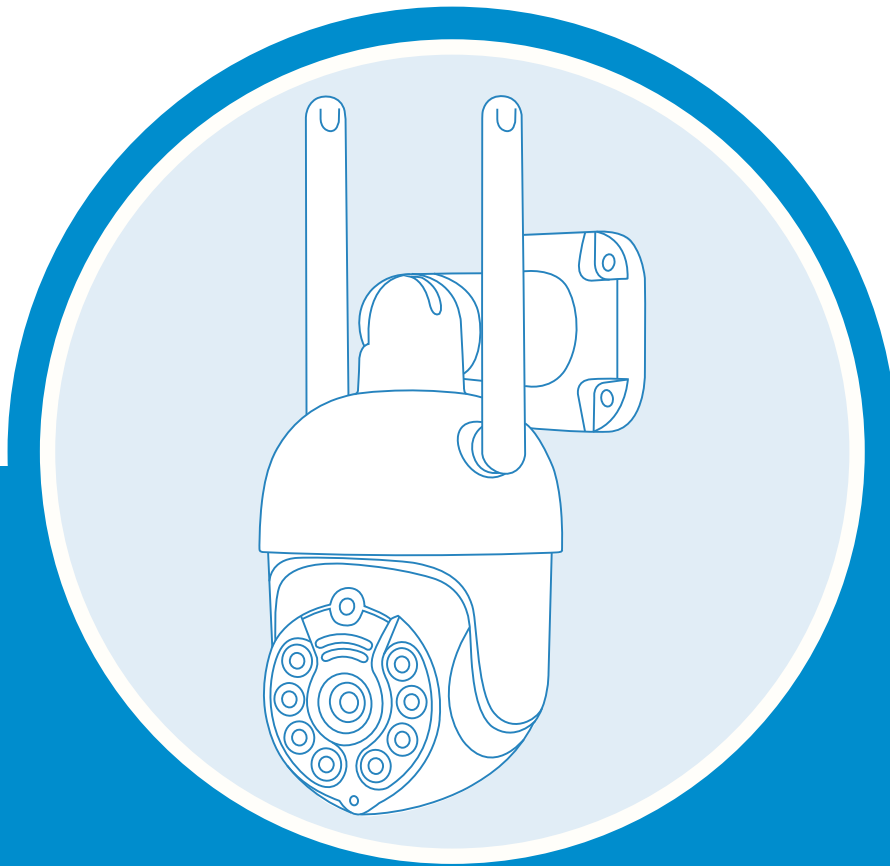

Security Expert for Your Home and Business

[www.techage.com](http://www.techage.com)

# Table of Content

01. About the WiFi AI Camera

02. View on Smart Phones

03. View on Web Browsers

04. View on PC Software

## Techage WiFi AI Camera

Thank you for purchasing Techage security WiFi AI Camera. Techage is committed to providing customers with high quality and reliable security products and solutions.

This quick user guide will help you learn fast and make it work easily. For detailed and latest user manual, you can download the PDF user manual on our website : [www.techage.com](http://www.techage.com)

### 01 About the WiFi AI Camera

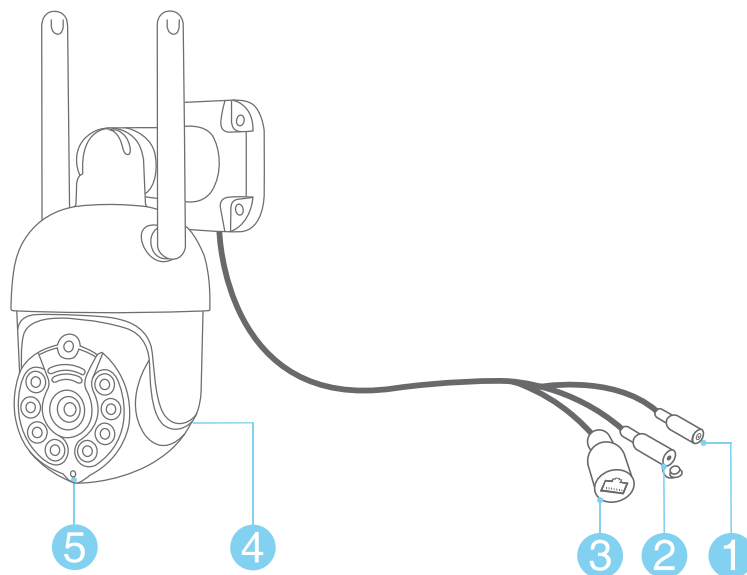

1. DC Power Port: Power Input 12V 1A.
2. Reset Button: Reset the camera to be factory defaults and into WiFi searching mode.
3. RJ45 Port: For Ethernet cable to the router
4. Speaker: For two way talk ,alert Voice play , alarm sound or broadcast
5. Microphone: For picking up audio (For different models, the position of the MIC may be different.)

This WiFi camera is an AI camera, with flood light on in the night after Human Shape Detection. Human Shape Detection is a smarter way to detect human motion with AI tech. It is much more accurate than motion sensor and common motion detection and with no false alarm because of pets or swinging branches of trees.

This WiFi camera is with a speaker, which is for two way talk and alert voice play. When human detected or alarm, it will play alert voice message like : "Alert area, please leave" , "Hello, welcome ! " or alarm sound if this feature is turned on. (As factory defaults it is off.)

### Insert or take out the TF card

Remove the card slot cover to insert TF card or take out.

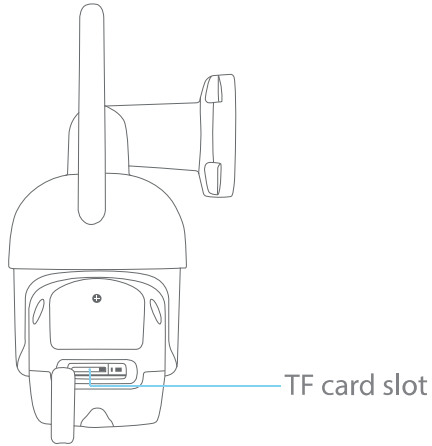

## 02 View on Smart Phones

### 1. Download and Install the iCsee App

Scan the QR code below to download the “iCsee” app or search “iCsee” in App Store or Google Play to download it. When you install it, please allow all the authorizations if you want full functions and alarm pushes anytime.



iOS

Android

### 2. Add the AI Camera to WiFi

After installing the app on your smart phones, you can register an account in it and start adding your WiFi AI camera in it.

## 2.1 Smart WiFi Setup

Power on the camera with the power adapter. The white lights in the camera will be on for seconds, and the camera will be in WiFi and initialization mode and you can add your camera to WiFi. (You can also press the reset button to get the camera into the initialization mode and program the WiFi.)

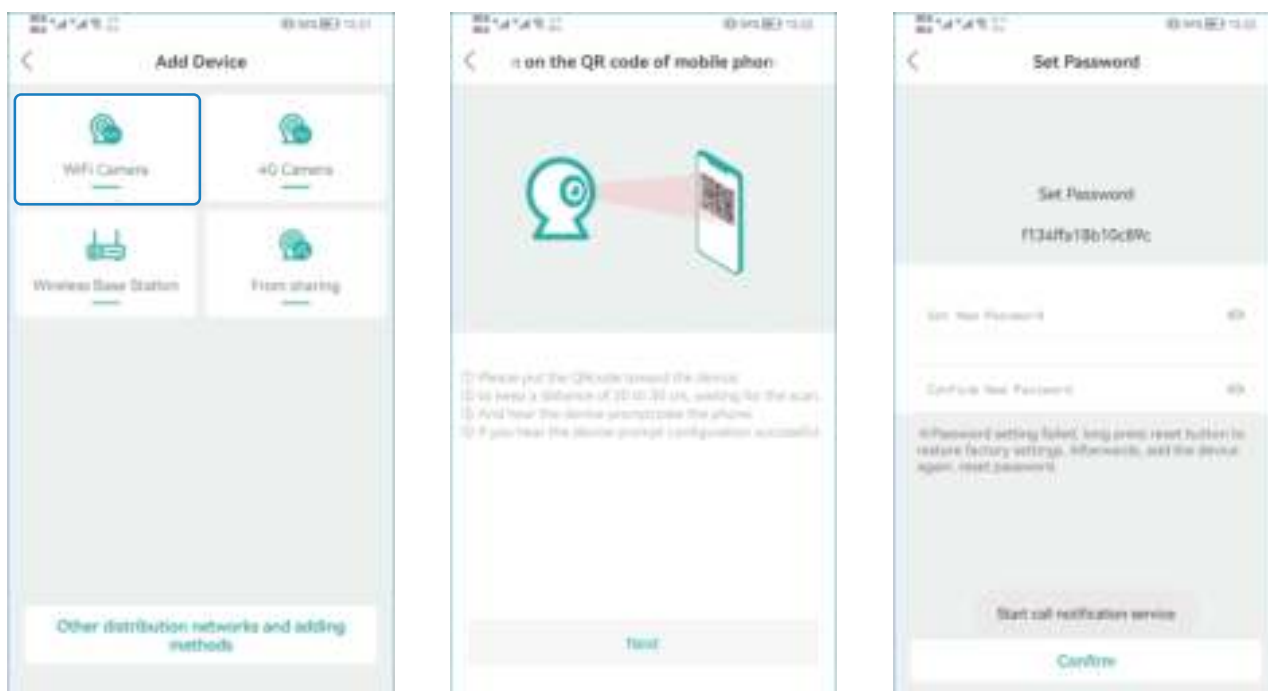

Before adding, please ensure your smart phone is connected to the WiFi of the same router as the WiFi AI Camera. And keep the camera and your smart phone nearby the router within 10 feet.

Click the "+" on the top right corner, then choose "WiFi Camera", and then follow the steps, there will be voice prompt for each step. After you set the WiFi into the camera successfully you will hear a voice prompt and it will go to the "Set Password" page. After password setting, you can name the device and start enjoying the video surveillance.

If you still can not connect the WiFi to the camera successfully, please try to use the wired Ethernet cable to connect it to WiFi as below.

## 2.2 Wired Ethernet Cable to Setup WiFi

Use the Ethernet cable with the camera to connect it to the router. Ensure your smart phone is connected to the router's WiFi. Click the "+" on the top right corner, and then at the bottom, click "other distribution networks and adding methods", then choose "Nearby Cameras", it will start searching the cameras connected to the router with the Ethernet cable. Choose the camera you want to add and go back to Device page to check it.

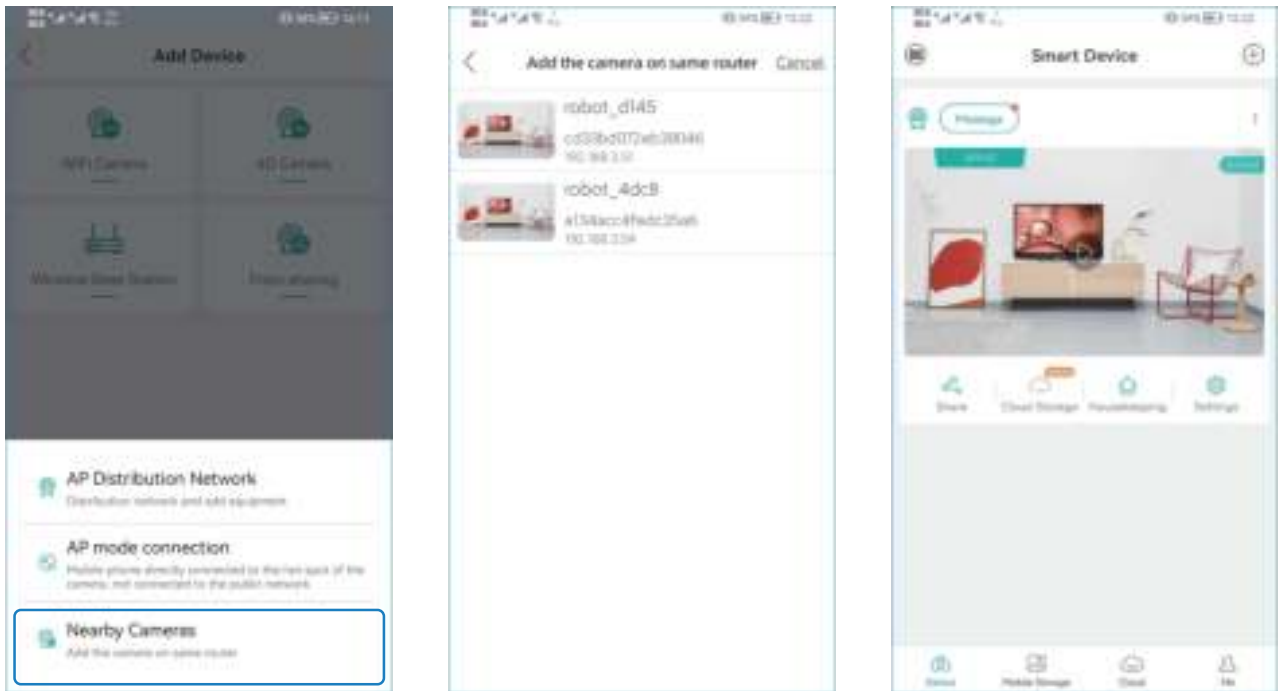

After you added the camera into the App, then Click  Setting and go to “Network Settings” page. Choose the WiFi network that connected to the phone and then click “Save”. After that plug off the Ethernet cable from the camera, you will hear a prompt “Connect the router successfully!”, which tells that it is connected to the WiFi network.

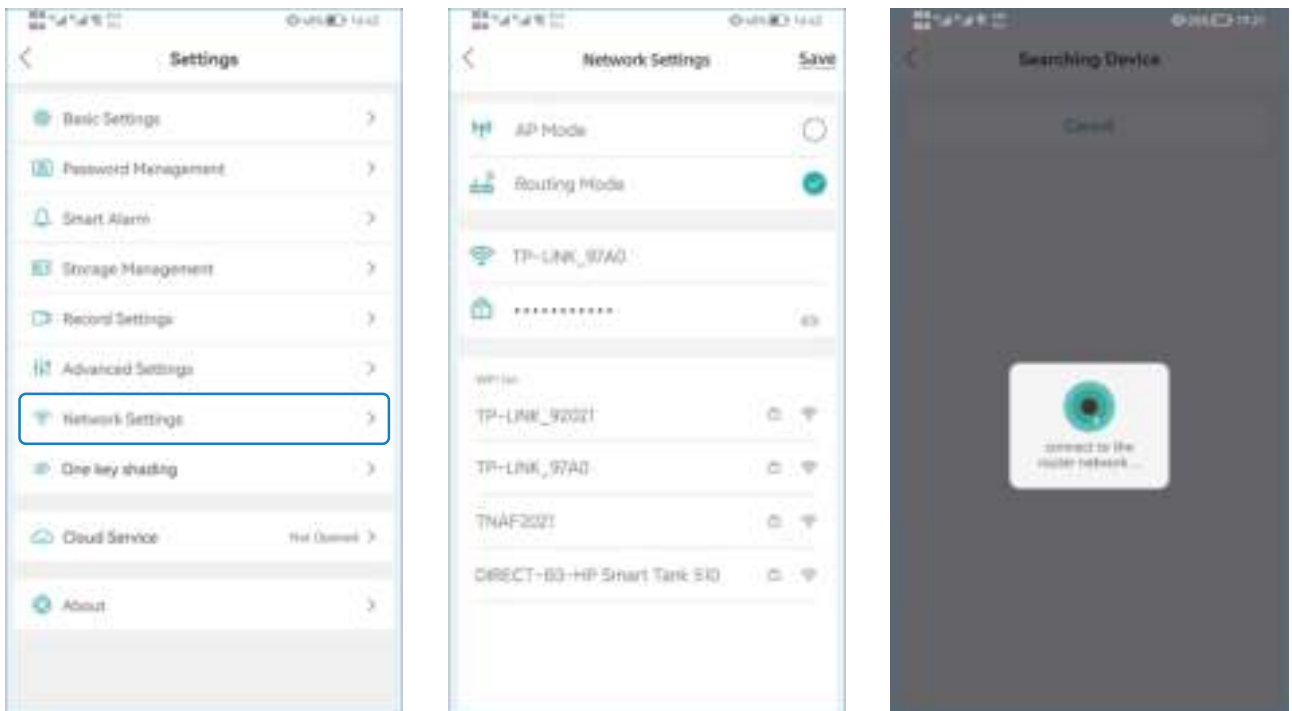

### 3. Using the App

After the camera is added into the app, follow steps below to do settings and control it.

### Control the camera

Click the video image of the camera and then you can do snapshot, two way intercom and playback the video recorded on the TF card. Click  to record video clips, it will count the seconds of the recorded video clips that you've recorded on your mobile phone.

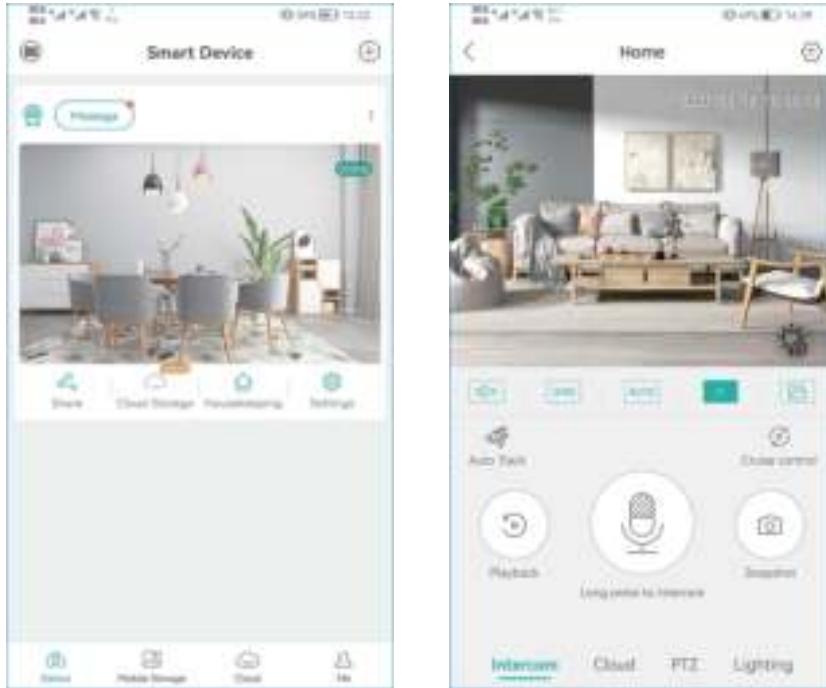

You can find the picture snapshot and the video clips you made on your phone “Mobile Storage” [Settings](#)

In the settings, you can do basic setting, like name the device, language and so on. You can change the password, do alarm settings, open or close the alarm push, check storage and network settings.

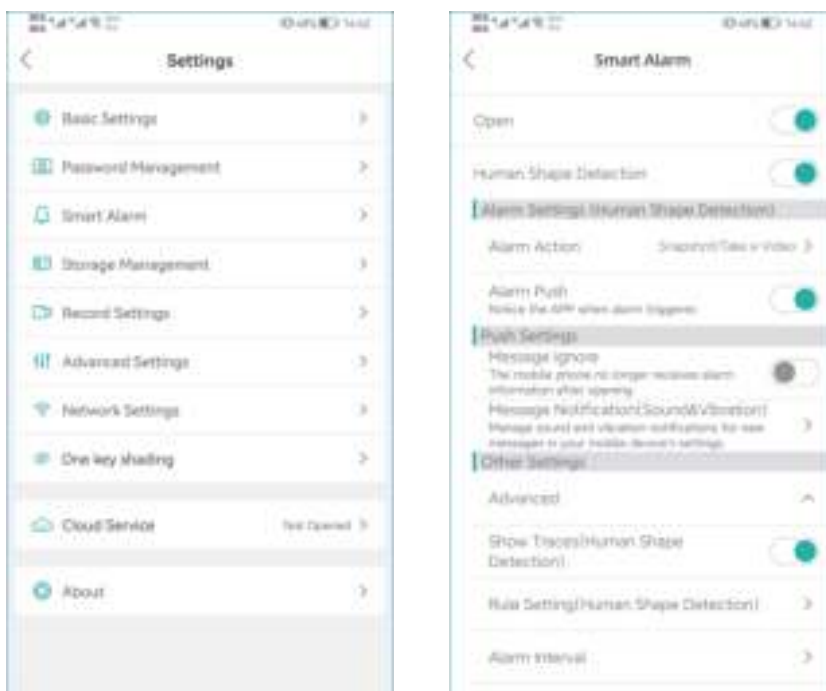

## 4. Unique features

### Alarm Voice Alert

In the Smart Alarm,click the "Alarm Action". You can set what the camera does after alarms.

It can snapshot , take a video and at the same time it will beep or play voice prompt. You can click "Bell Alarm" to choose what prompt voice it will play after alarms. You can choose "Alert area, please leave" , "Hello, welcome ! " or "Howling Alarm". As default this function is closed. Please do remember save it after

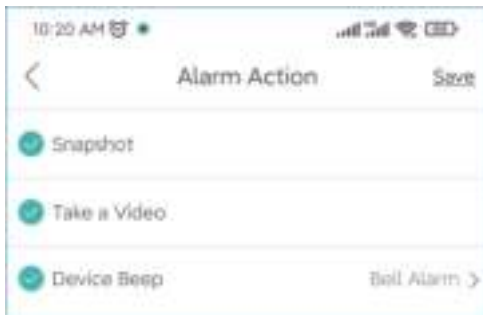

### Flood Light

On the live video, click the  icon. It will show the IR light settings for the camera. There are two types of lights in the camera, IR light and white light, and they have three modes.

White Light Mode: The white light will be on all the time in the night.

Normal: Only IR light will be on in the night. And the white light will be off day and night.

Double Light Mode: The IR light will be on in the night and the white light will be turned on in the night after human detection. (It is the default mode of the camera.)





## AI Smart Features

On the live video ,click the  icon, you can find the "Intelligent Vigilance". There are smart AI functions, like "Human Shape Detection", "Show Traces" "Cordon" and "Alert Area" Settings.

### ◆Human Shape Detection

Human Shape Detection is a smarter way to detect human motion with AI tech. It is much more accurate than motion sensor and common motion detection and with no false alarm because of pets or swinging branches of trees.

### ◆Show Traces

When this function is on, there will be a trace frame,when people are in the live video and it will follow the people when they are moving.

### ◆Cordon and Alert Area

There are two ways to set the protection zones. One is cordon, the other is alert area. For the cordon, you can put a cordon in the video image and when people cross it, it will alarm. You can set different alert directions for the cordon. You can draw different shapes for the zone that you want to protect in the live video image.

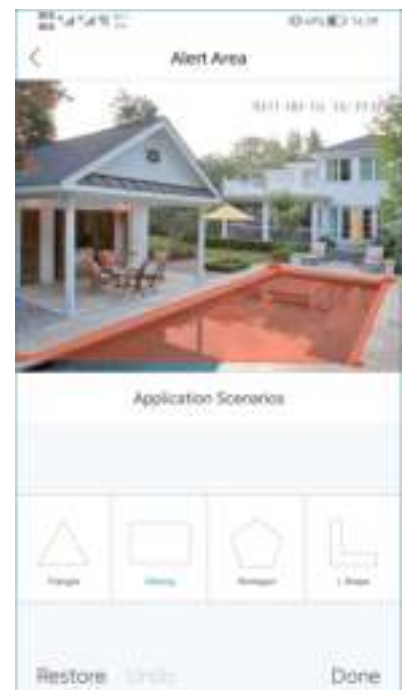
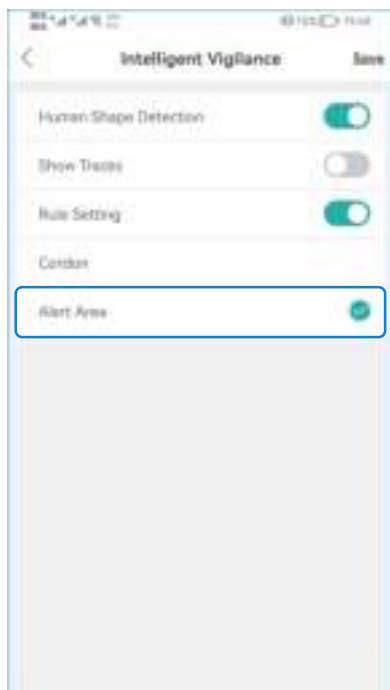

## 03 View on Web Browsers

You can also view the videos on web browsers. Internet Explorer is highly recommended as the one that has the best compatibility. [www.xmeye.net](http://www.xmeye.net) is the web server that used for the web view. Before you can view it from web, you need to install the ActiveX. You can find it as below



If you have many cameras, you can manage the cameras by user. If you only have one camera, we recommend you view it by device. You can find the device serial number from your app, find it on app, in "Settings" >> "About" >> "Serial Number", click to copy  it.



## 04 View on PC Software

- Step 1: Download PC software from <https://www.techage.com/pages/download>. VMS for Macbook and CMS for windows PC. After opening the pc software, click "Login" directly. Do not need to input password, as default none password, just leave it blank.
- Step 2: Choose Device Manager>IP4 search, then find your NVR and choose it. Click "Add"

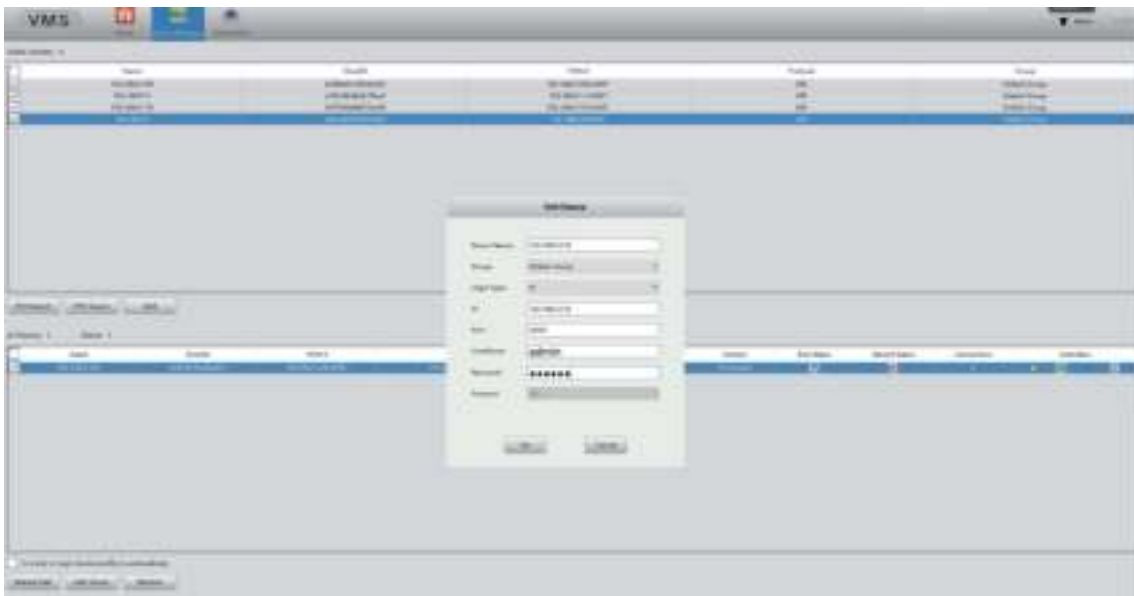

After that click the  to edit the device, and update the password if you've already changed the password of the device.

And then back to Home page and click "Live View", double click your device IP and you can view your device in the VMS.





All rights reserved. No part of this publication may be reproduced by any means without written permission from Techage. The information in this publication is believed to be accurate in all respects.

Techage can not assume responsibility for any consequences resulting from the use thereof. The information contained herein is subject to change without notice. Revisions or new editions to this publication may be issued to incorporate such changes.

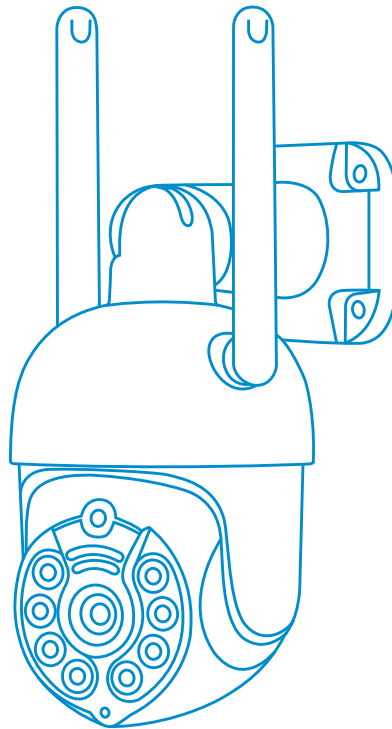

[www.techage.com](http://www.techage.com)  
[support@techage.com](mailto:support@techage.com)

**RoHS**   



[www.techage.com](http://www.techage.com)  
[support@techage.com](mailto:support@techage.com)