

# Outdoor Wi-Fi Security Camera HM211 User Manual

Please read this manual thoroughly before using and keep it for future use.

This device complies with part 15 of the FCC Rules. Operation is subject to the following two conditions:

- (1) this device may not cause harmful interference, and
- (2) this device must accept any interference received, including interference that may cause undesired operation.

## Product Overview

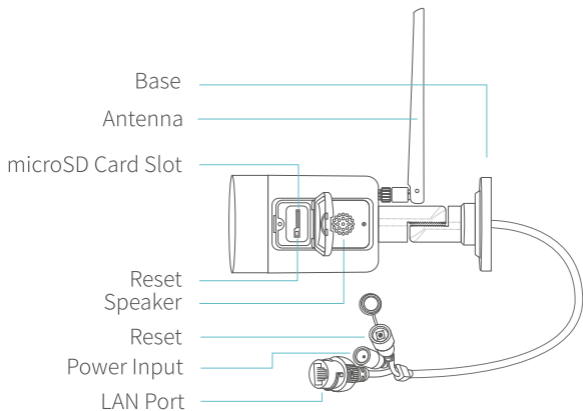
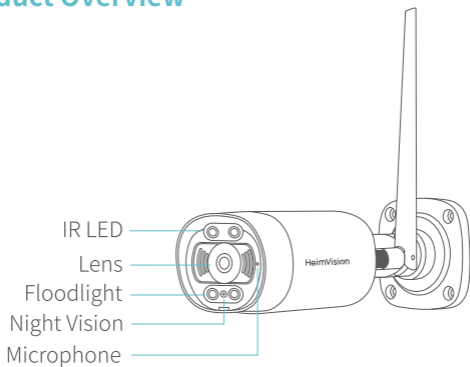

## Download the App

### Option 1:

Search and download **PixPlus** from Google Play or **PixPlus-EN** from App Store ;

### Option 2:

Scan the QR code below to download.



For Android



For iOS

## Account Registration and Login

Please register an account with a valid email address at your first use of this App, then log in.

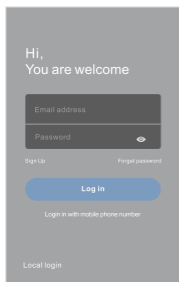

Hi,  
You are welcome

Email address

Password

Sign Up      Forget password

**Log in**

Log in with mobile phone number

Local login

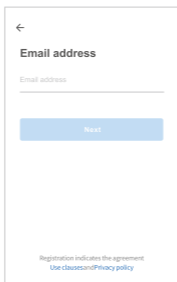

←

**Email address**

Email address

**Next**

Registration indicates the agreement  
[Use clauses](#) and [Privacy policy](#)

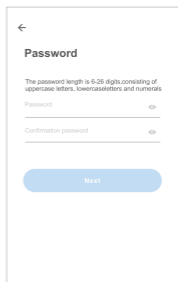

←

**Password**

The password length is 6-26 digits, consisting of uppercase letters, lowercase letters and numerals

Password

Confirmation password

**Next**

### Notes:

If you did not receive an activation email, please check your SPAM or contact us at [support@heimvision.com](mailto:support@heimvision.com).

# Connecting the Camera to Your Mobile Device

## IMPORTANT:

- (1) This camera only supports 2.4GHz Wi-Fi;
- (2) For a stable network connection, please make sure the camera and the mobile device are close to the router. At the same time, please install the antenna for the camera after you adjust the base to provide enough space for it.
- (3) Do not mount the camera before confirming the successful network connection and smooth live picture.

## 1. Connecting by Scanning the QR Code

You will hear "Camera start. Wait for connection" after the camera is powered on. Press and hold the **Reset** button for 5-6s to reset the camera if no voice prompts. You will hear "Reset Success, please wait reboot" at a successful reset.

### Step 1:

Connect the mobile device to your Wi-Fi, then log in to **PixPlus**. Tap **+** in the upper right corner, then select **Intelligent camera** and **Device adding by scanning the code**;

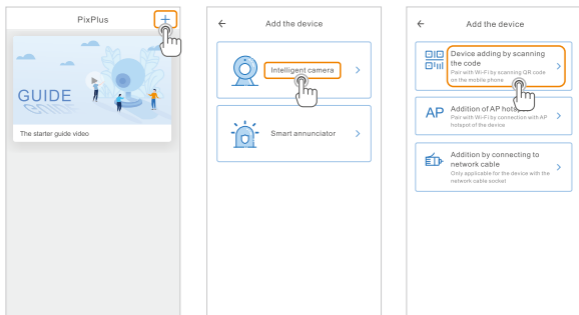

## Step 2:

Tick **If you have finished the above steps, click Connect to the Network**, then tap **Connect to the Network**. Select the Wi-Fi your mobile device is connected, enter the correct password and tap **Next** to continue;

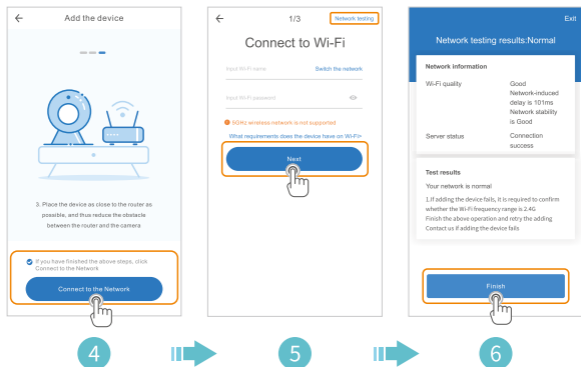

## Tip:

You can tap **Network testing** in the upper right corner of **Connect to Wi-Fi** interface to check the status of your Wi-Fi connection.

## Step 3:

Align the QR code on your mobile device with the camera lens and keep a distance of 4-8 inches. When the QR code is clear, slightly move your mobile device forward and backward for better scanning.

## Step 4:

Tap **I heard the "beep" voice** to connect to the Internet after 2 beeps from the camera. During the process, you will hear "Network connecting, please wait". When you hear "Wi-Fi connection success. Camera is online", the camera is connected to **PixPlus** successfully.

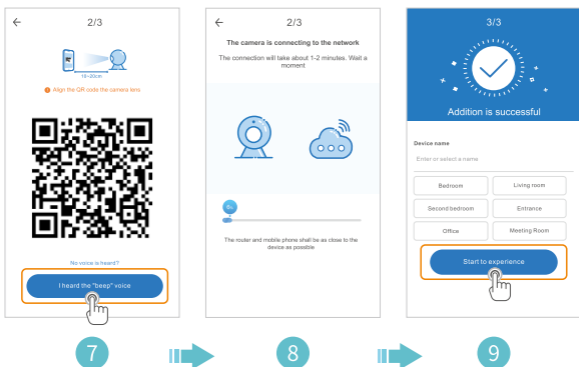

## 2. Connecting by AP Hotspot

You will hear "Camera start. Wait for connection" after the camera is powered on. Press and hold the **Reset** button for 5-6s to reset the camera if no voice prompts. You will hear "Reset Success, please wait reboot" at a successful reset.

### Step 1:

Connect the mobile device to your Wi-Fi, then log in to PixPlus. Tap **+** in the upper right corner, then select **Intelligent camera** and **Addition of AP hotspot**;

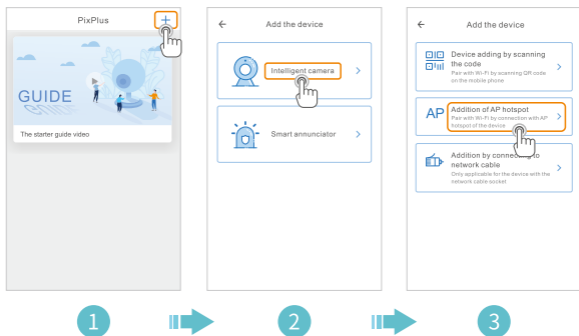

### Step 2:

Tick **If you have finished the above steps**, click **Next**, then tap **Next** to enter the **Network configuration** interface;

### Step 3:

Tap **Go to Setting** to enter the network setting interface of the mobile device, then connect to the **PIXPLUS\_AP\_XXXX** Wi-Fi;



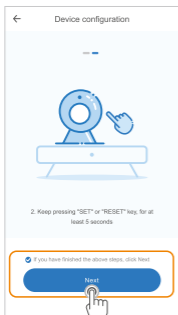

4



5

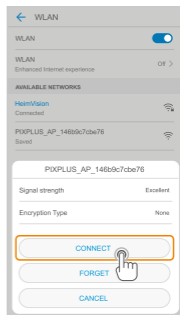

6

## Step 4:

Tap  to get back to PixPlus and enter Network configuration interface, then tap Next to continue;

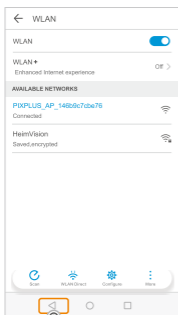

7

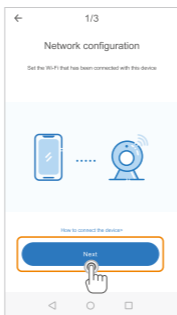

8

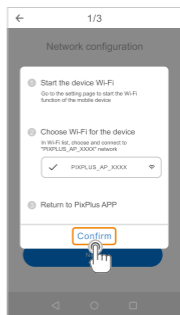

9

## Tips:

1. There will be a pop-up window if the **PIXPLUS\_AP\_XXXX** Wi-Fi connection is failed. Tap **Confirm** to connect again;
2. If you still cannot connect to the **PIXPLUS\_AP\_XXXX** Wi-Fi, it may be prohibited by the security setting of your mobile device. Please change your setting or contact us at [support@heimvision.com](mailto:support@heimvision.com).

## Step 5:

Select the Wi-Fi your mobile device is connected, enter the correct password, then tap **Confirm**. The camera will connect to the Internet after 2 beeps from the camera. During the process, you will hear "Network connecting, please wait". When you hear "Wi-Fi connection success. Camera is online", the camera is connected to **PixPlus** successfully.

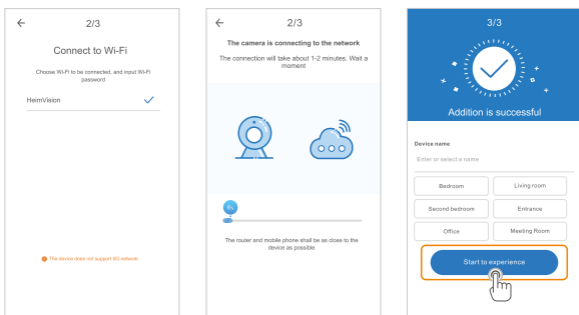

10



11



12

### 3. Connecting by the LAN Cable

You will hear "Camera start. Please add camera via network cable" after the camera is connected to the LAN cable and powered on. Press and hold the **Reset** button for 5-6s to reset the camera if no voice prompts. You will hear "Reset Success, please wait reboot" at a successful reset;

#### Step1:

Log in to **PixPlus**. Tap **+** in the upper right corner, then select **Intelligent camera** and **Addition by connecting to network cable**;

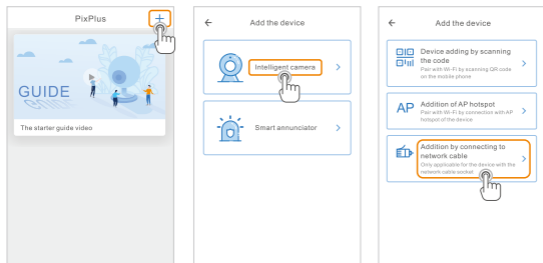

#### Step 2:

Tick **If you have finished the above steps**, click **Next**, then tap **Next** to enter the interface of Configure the camera. Scan the QR code on the bottom of the camera and wait. During the process, you will hear "Network connecting, please wait". When you hear "Camera is online", the camera is connected to **PixPlus** successfully.

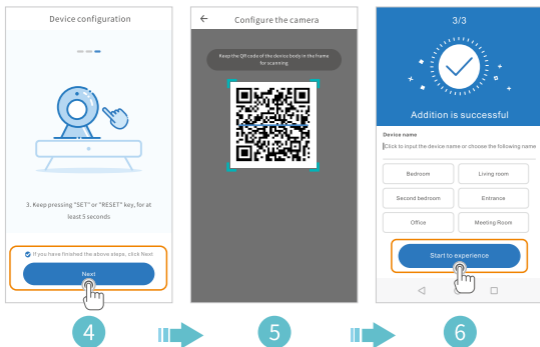

## Tip:

After the camera is connected to the App with the LAN Cable, you can switch to Wi-Fi connection for flexible placement and operation of the camera. Go to the interface of **Setting**, select **Change Wi-Fi network** and input the correct password. After successfully connecting to the Wi-Fi you selected, unplug the LAN cable and reboot the camera.

# Connecting the Camera to Amazon Alexa

## Step 1:

Log in to Amazon Alexa with your Amazon account after downloading and installing it, tap  on the left upper corner of the Home page, then select **Skills & Games**;

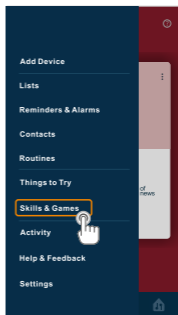
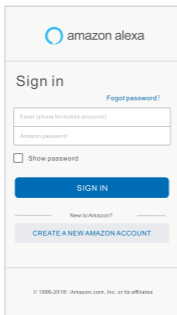

## Step 2:

Search and select **Closetli**, then enable it by tapping **ENABLE TO USE**;

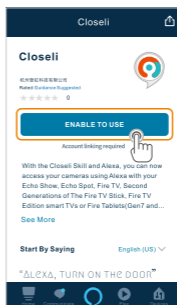
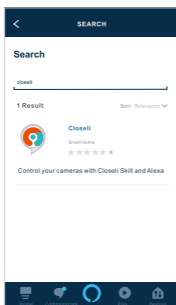

### Step 3:

Log in to **Closeli** with your **PixPlus** account, then allow **Amazon Alexa** to link with your **PixPlus** account by tapping **Allow**.

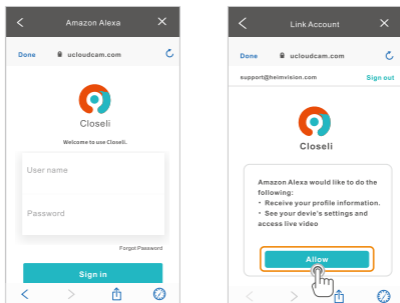

### Note:

**Closeli** is the application that helps **PixPlus** realize **Alexa's Skill**.

### Step 4:

Close the page of **Closeli** has been successfully linked after a successful link, then tap **DISCOVER DEVICES** in the pop-up page to discover the camera in **PixPlus**.

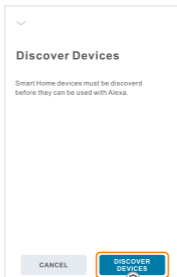
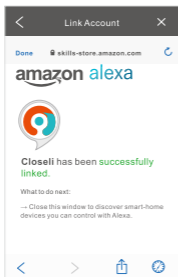

## Step 5:

After discovering, tap **CHOOSE DEVICE** to start the experience. You can control your camera with Amazon Alexa by starting to say "Alexa, show the camera" to enter the LIVE picture interface, and say "Alexa, stop" to exit from it.

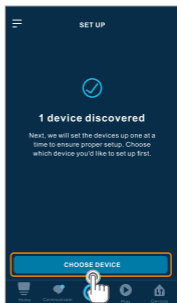
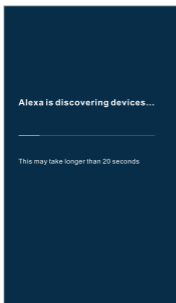

## Note:

For renaming the linked camera or linking a new camera with Amazon Alexa, please discover the device from Amazon Alexa again.

## Camera Installation and Adjustment

After confirming the successful Wi-Fi connection and smooth LIVE picture, select your ideal mounting position.

### Step 1:

Drill 4 screw holes on the wall/ceiling according to the base of the camera, then insert 4 green plastic expansion pipes into the holes;

### Step 2:

Fix the base of the camera into the expansion pipes with 4 metal screws.

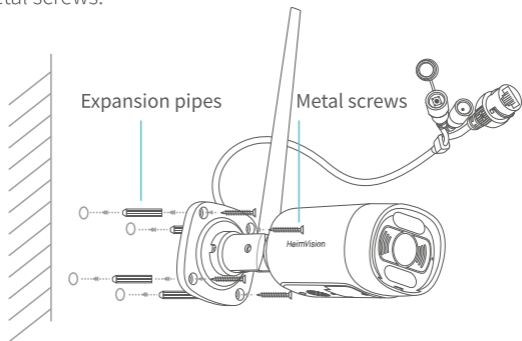

### Step 3:

Loosen the screws to adjust the angle of the camera and tighten the screws after the adjustment.



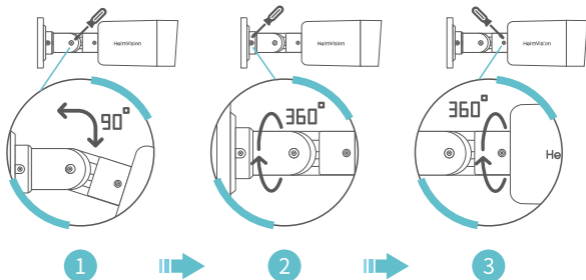

### Tips:

1. The 5dB antenna can strengthen the Wi-Fi signal, but obstacles like wall, furniture, etc., will cause signal attenuation. If the mounting position of the camera is with poor network, an extra repeater or LAN connection is recommended.
2. This IP65 camera can be used for outdoor. Please make sure the power input and LAN port are waterproof to avoid the water leakage after mounting it outdoor.
  - \* IP65 is rated as "dust tight" and protected against water projected from a nozzle.
3. Install the microSD card before mounting the camera if it's needed. Keep the SD card slot facing down and avoid mounting the camera in a location that will be impacted and soaked by rain.
4. Please keep the screws well when installing the microSD card and adjusting the camera.

## Function Overview

After successfully connecting the camera to PixPlus, it will show the thumbnail of the camera in the main interface.

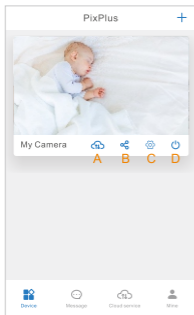

- A. Cloud service
- B. Private share
- C. Setting
- D. Device switch

### Cloud service (optional) :

Tap it to check subscription packages, renew the subscription and enter the activation code. If you haven't subscribed a cloud service package, please install a microSD card to record and save video.

### Private share:

Share the camera with the account of your family member, then they can watch the live picture or the videos recorded accordingly. The shared account should be a registered account of PixPlus.

### Setting:

Set up more functions for the camera.

### Device switch:

Turn on/off the camera remotely.

Tap on the thumbnail to enter the **LIVE** interface.

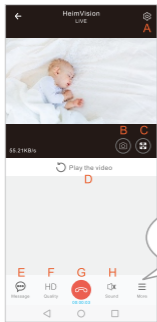

- A. Setting
- B. Snapshot
- C. Full Screen
- D. Video Playback
- E. Messages
- F. Image Quality
- G. Call
- H. Sound
- I. Record
- J. Cloud Album
- K. Auto

### Video Playback:

\*If a microSD card is installed, go to the interface of **Setting**, tap **Play Videos From**, then select **Memory card** to watch the videos recorded in the microSD card.

\*If the camera is subscribed with Cloud service, tap this icon to play the video recorded in the cloud directly.

### Messages:

Tap it to watch all the videos recorded when the camera detects the sound, motion and so on. This function is only available in the camera with **Cloud Service**.

### Image Quality:

Switch the image quality between **HD** and **SD**. **SD** is recommended for a smoother streaming.

### Call:

Tap it to talk with people through the camera.

## Sound:

To hear sound from the camera, please unmute **Sound**.

(  means the sound is muted).

## Record:

Tap it to start recording the current live video, tap again to end and save it to the internal storage of your mobile device.

## Auto:

Tap it to set up the modes of the floodlights on the camera. It includes **ON**, **OFF** and **Auto**.

## Troubleshooting Guide

### Q1. How can I watch the videos from PC?

- \* Please visit <https://www.ucloudcam.com>, then log in to the system with your **Pixplus** App account and password.

### Q2. Why can't I get push notifications of alerts on my mobile device?

- \* Make sure you allow **PixPlus** to send you notifications in the settings of your mobile device.
- \* Make sure you switch on all the options in **Push Notification Settings**.
- \* Make sure the current time is not during the scheduled time that stops the notification.
- \* When you watch the live video of the camera, the mobile device will not get any notification.
- \* **Email notification** is only available for the camera with **Cloud Service**.

### Q3. How can I turn off the floodlights?

The image of the camera will be black & white at night if the **Night Vision** is **ON**. If there is alert when the camera detects a moving object, the floodlights will be on and the image of the camera will turn to colorful. When the alert stops, the floodlights will be off and the image of the camera will turn to black & white.

- \* Go to the **LIVE** interface of the camera, tap **More** and **Auto**, then tap **OFF** to turn off the floodlights.

### Q4. Why does the camera make alerts when there are no moving objects?

The camera recognizes the moving objects according to the change of the image pixel, so the changes of the light and shadow within the monitoring area might be detected as moving objects.

- \* Go to **Setting > Detection Sensitivity** to lower the detection sensitivity to reduce the false alerts.
- \* Go to **Setting > Detection area** to select the area for motion detection to reduce the unnecessary false alerts.



Scan for Online User Manual

## CUSTOMER SUPPORT

**North America:** [support@heimvision.com](mailto:support@heimvision.com)

**United Kingdom:** [support.uk@heimvision.com](mailto:support.uk@heimvision.com)