

Trademarks

FOXWELL is trademark of Shenzhen Foxwell Technology Co., Ltd.
All other marks are trademarks or registered trademarks of their respective holders.

Copyright Information

©2020 Shenzhen Foxwell Technology Co., Ltd.
All rights reserved.

Disclaimer

The information, specifications and illustrations in this manual are based on the latest information available at the time of printing.
Foxwell reserves the right to make changes at any time without notice.

Visit our website at

www.foxwelltech.us

For Technical Assistance, send us email at

support@foxwelltech.com



One-Year Limited Warranty

Subject to the conditions of this limited warranty, Shenzhen Foxwell Technology Co., Ltd (“FOXWELL”) warrants its customer that this product is free of defects in material and workmanship at the time of its original purchase for a subsequent period of one (1) year.

In the event this product fails to operate under normal use, during the warranty period, due to defects in materials and workmanship, FOXWELL will, at its sole option, either repair or replace the product in accordance with the terms and conditions stipulated herein.

Terms and Conditions

1 If FOXWELL repairs or replaces the product, the repaired or replaced product shall be warranted for the remaining time of the original warranty period. No charge will be made to the customer for replacement parts or labor charges incurred by FOXWELL in repairing or replacing the defective parts.

2 The customer shall have no coverage or benefits under this limited warranty if any of the following conditions are applicable:

a) The product has been subjected to abnormal use, abnormal conditions, improper storage, exposure to moisture or dampness, unauthorized modifications, unauthorized repair, misuse, neglect abuse, accident, alteration, improper installation, or other acts which are not the fault of FOXWELL, including damage caused by shipping.

b) The Product has been damaged from external causes such as collision with an object, or from fire, flooding, sand, dirt, windstorm, lightning, earthquake or damage from exposure to weather conditions, an Act of God, or battery leakage, theft, blown fuse, improper use of any electrical source, or the product was used in combination or connection with other product, attachments, supplies or consumables not manufactured or distributed by FOXWELL.

3 The customer shall bear the cost of shipping the product to FOXWELL. And FOXWELL shall bear the cost of shipping the product back to the customer after the completion of service under this limited warranty.

4 FOXWELL does not warrant uninterrupted or error-free operation of the product. If a problem develops during the limited warranty period, the consumer shall take the following step-by-step procedure:

a) The customer shall return the product to the place of purchase for repair or replacement processing, contact your local FOXWELL distributor or visit our website www.foxwelltech.us to get further information.

b) The customer shall include a return address, daytime phone number and/or fax number, complete description of the problem and original invoice specifying date of purchase and serial number.

c) The customer will be billed for any parts or labor charges not covered by this limited warranty.

d) FOXWELL will repair the Product under the limited warranty within 30 days after receipt of the product. If FOXWELL cannot perform repairs covered under this limited warranty within 30 days, or after a reasonable number of attempts to repair the same defect, FOXWELL at its option, will provide a replacement product or refund the purchase price of the product less a reasonable amount for usage.

e) If the product is returned during the limited warranty period, but the problem with the product is not covered under the terms and conditions of this limited warranty, the customer will be notified and given an estimate of the charges the customer must pay to have the product repaired, with all shipping charges billed to the customer. If the estimate is refused, the product will be returned freight collect. If the product is returned after the expiration of the limited warranty period, FOXWELL' normal service policies shall apply and the customer will be responsible for all shipping charges.

5 ANY IMPLIED WARRANTY OF MERCHANTABILITY, OR FITNESS FOR A PARTICULAR PURPOSE OR USE, SHALL BE LIMITED TO THE DURATION OF THE FOREGOING LIMITED WRITTEN WARRANTY. OTHERWISE, THE FOREGOING LIMITED WARRANTY IS THE CONSUMER'S SOLE AND EXCLUSIVE REMEDY AND IS IN LIEU OF ALL OTHER WARRANTIES, EXPRESS OR IMPLIED. FOXWELL SHALL NOT BE LIABLE FOR SPECIAL, INCIDENTAL, PUNITIVE OR CONSEQUENTIAL DAMAGES, INCLUDING BUT NOT LIMITED TO LOSS OF ANTICIPATED BENEFITS OR PROFITS, LOSS OF SAVINGS OR REVENUE, LOSS OF DATA, PUNITIVE DAMAGES, LOSS OF USE OF THE PRODUCT OR ANY ASSOCIATED EQUIPMENT, COST OF CAPITAL, COST OF ANY SUBSTITUTE EQUIPMENT OR FACILITIES, DOWNTIME, THE CLAIMS OF ANY THIRD PARTIES, INCLUDING CUSTOMERS, AND INJURY TO PROPERTY, RESULTING FROM THE PURCHASE OR USE OF THE PRODUCT OR ARISING FROM BREACH OF THE WARRANTY, BREACH OF CONTRACT, NEGLIGENCE, STRICT TORT, OR ANY OTHER LEGAL OR EQUITABLE THEORY, EVEN IF FOXWELL KNEW OF THE LIKELIHOOD OF SUCH DAMAGES. FOXWELL SHALL NOT BE LIABLE FOR DELAY IN RENDERING SERVICE UNDER THE LIMITED WARRANTY, OR LOSS OF USE DURING THE PERIOD THAT THE PRODUCT IS BEING REPAIRED.

6. Some states do not allow limitation of how long an implied warranty lasts, so the one-year warranty limitation may not apply to you (the Consumer). Some states do not allow the exclusion or limitation of incidental and

consequential damages, so certain of the above limitations or exclusions may not apply to you (the Consumer). This limited warranty gives the Consumer specific legal rights and the Consumer may also have other rights which vary from state to state.

Safety Information

For your own safety and the safety of others, and to prevent damage to the equipment and vehicles, read this manual thoroughly before operating your tool. The safety messages presented below and throughout this user's manual are reminders to the operator to exercise extreme care when using this device. Always refer to and follow safety messages and test procedures provided by vehicle manufacturer. Read, understand and follow all safety messages and instructions in this manual.

Safety Message Conventions Used

We provide safety messages to help prevent personal injury and equipment damage. Below are signal words we used to indicate the hazard level in a condition.

DANGER

Indicates an imminently hazardous situation which, if not avoided, will result in death or serious injury to the operator or to bystanders.

WARNING

Indicates a potentially hazardous situation which, if not avoided, could result in death or serious injury to the operator or to bystanders.

CAUTION

Indicates a potentially hazardous situation which, if not avoided, may result in moderate or minor injury to the operator or to bystanders.

Important Safety Instructions

And always use your tool as described in the user's manual, and follow all safety messages.

WARNING

- Do not route the test cable in a manner that would interfere with driving controls.
- Do not exceed voltage limits between inputs specified in this user's manual.
- Always wear ANSI approved goggles to protect your eyes from propelled objects as well as hot or caustic liquids.

- Fuel, oil vapors, hot steam, hot toxic exhaust gases, acid, refrigerant and other debris produced by a malfunction engine can cause serious injury or death. Do not use the tool in areas where explosive vapor may collect, such as in below-ground pits, confined areas, or areas that are less than 18 inches (45 cm) above the floor.
- Do not smoke, strike a match, or cause a spark near the vehicle while testing and keep all sparks, heated items and open flames away from the battery and fuel / fuel vapors as they are highly flammable.
- Keep a dry chemical fire extinguisher suitable for gasoline, chemical and electrical fires in work area.
- Always be aware of rotating parts that move at high speed when an engine is running and keep a safe distance from these parts as well as other potentially moving objects to avoid serious injury.
- Do not touch engine components that get very hot when an engine is running to avoid severe burns.
- Block drive wheels before testing with engine running. Put the transmission in park (for automatic transmission) or neutral (for manual transmission). And never leave a running engine unattended.
- Do not wear jewelry or loose fitting clothing when working on engine.

Table of Contents

ONE-YEAR LIMITED WARRANTY	2
SAFETY INFORMATION	5
SAFETY MESSAGE CONVENTIONS USED	5
IMPORTANT SAFETY INSTRUCTIONS	5
1 USING THIS MANUAL	10
1.1 BOLD TEXT	10
1.2 SYMBOLS AND ICONS	10
1.2.1 Solid Spot	10
1.2.2 Arrow Icon	10
1.2.3 Note and Important Message	10
2 INTRODUCTION	11
2.1 SCANNER DESCRIPTIONS	11
2.2 VCI DONGLE DESCRIPTIONS	13
2.3 ACCESSORIES	15
2.4 TECHNICAL SPECIFICATIONS	16
3 GETTING STARTED	16
3.1 POWERING UP THE SCANNER	16
3.1.1 Internal Battery Pack	17
3.1.2 External Power Supply	17
3.2 SHUTTING DOWN THE SCANNER	17
3.3 ESTABLISHING VEHICLE COMMUNICATION	17
3.3.1 VCI Connection	18
3.3.1.1 Bluetooth Communication	18
3.3.1.2 USB Communication	20
3.4 SCREEN LAYOUT OF HOME SCREEN	20
3.4.1 Application Menu	21
3.4.2 Navigation Toolbar	21
3.4.3 Diagnostic Menu	23
4 VEHICLE IDENTIFICATION	23
4.1 VIN READING	24
4.1.1 Automatic Read	24
4.1.2 Scan VIN	26
4.1.2.1 Scan VIN Plate	26
4.1.2.2 Scan Barcode/QR Code of VIN	27
4.1.2.3 Photo Recognition	28

4.1.3 Manual Entry	29
4.2 MANUAL SELECTION	30
4.2.1 Smart VIN	31
4.2.2 Manual Vehicle Selection	32
4.3 VEHICLE HISTORY	33
5 DIAGNOSIS	34
5.1 CONTROL MODULE SELECTION	34
5.1.1 Quick Scan	35
5.1.2 Control Modules	37
5.2 DIAGNOSTIC OPERATIONS	38
5.2.1 Read Codes	39
5.2.2 Clear Codes	41
5.2.3 Live Data	42
5.2.3.1 All Data	42
5.2.3.2 Custom List	46
5.2.4 ECU Information	46
5.2.5 Active Tests	47
5.2.6 Special Functions	49
5.3 SPECIAL FUNCTIONS	49
5.3.1 Service	49
5.3.2 Coding and Programming	50
5.3.3 Hot Functions	52
6 MAINTENANCE	53
6.1 OIL LIGHT RESET	53
6.2 ELECTRONIC PARKING BRAKE (EPB) SERVICE	54
6.3 BATTERY REPLACEMENT (BRT)	55
6.4 DIESEL PARTICULATE FILTER (DPF) REGENERATION	56
6.5 THROTTLE BODY ALIGNMENT (TPS/TBA)	56
6.6 STEERING ANGLE SENSOR (SAS) CALIBRATION	56
6.7 CONTINUOUS VARIABLE TRANSMISSION (CVT)	57
6.8 GEAR LEARNING	57
6.9 TIRE PRESSURE MONITORING SYSTEM PROGRAMMING	57
6.10 ODOMETER	57
6.11 INJECTOR CODING	57
6.12 ABS BLEEDING	57
6.13 KEY PROGRAMMING/ IMMOBILIZER	58
7 DATA MANAGER	58
7.1 IMAGE	58
7.1.1 How to Save an Image	59
7.1.2 Review Image	59
7.2 PDF REPORT	61

7.2.1 How to Create a PDF Report	61
7.2.2 Review PDF Report	61
7.3 DATA PLAYBACK	62
7.4 DATA LOGGING & DATA RECORD	63
8 VCI MANAGER	64
8.1 BLUETOOTH	64
8.2 UPDATE FIRMWARE	65
8.3 UNBIND A VCI DONGLE	66
9 REGISTRATION AND UPDATE	68
9.1 REGISTRATION	68
9.1.1 Register with Built-in Update Client	68
9.1.2 Register through Website	71
9.2 UPDATE	72
10 SETTINGS	73
10.1 CHANGE UNITS	73
10.2 LANGUAGE	73
10.3 PUSH MESSAGE	74
10.4 AUTOMATIC UPDATE	75
10.5 SYSTEM SETTINGS	75
10.6 GENERAL	75
10.7 UNINSTALL VEHICLE SOFTWARE	75
10.8 PRINT SETTINGS	76
10.9 ABOUT	78
11 SHOP MANAGER	79
11.1 VEHICLE HISTORY	79
11.2 WORKSHOP INFORMATION	80
12 MY ACCOUNT	80
12.1 MY ACCOUNT	81
12.2 MY PRODUCTS	81
12.3 PUSH MESSAGE	82
12.4 FEEDBACK AND SUGGESTIONS	82
13 REMOTE SUPPORT	83
14 TECHNICAL DATA	83

1 Using This Manual

We provide tool usage instructions in this manual. Below are the conventions we used in the manual.

1.1 Bold Text

Bold text is used to highlight selectable items such as buttons and menu options.

Example:

Select **Diagnostic** from home screen of the i80 application.

1.2 Symbols and Icons

1.2.1 Solid Spot

Operation tips and lists that apply to specific tool are introduced by a solid spot ●.

Example:

When VIN hotkey is selected, a menu that lists all available options displays. Menu options include:

- Automatic Read
- Scan VIN
- Manual Entry

1.2.2 Arrow Icon

 An arrow icon indicates a procedure.

Example:

 To connect to wall plug:

1. Connect the USB charge cable to scanner and plug it to the wall socket.
2. Press the power switch of the scan tool to power it on; meanwhile the scanner tool starts charging automatically also.

1.2.3 Note and Important Message

Note

A NOTE provides helpful information such as additional explanations, tips, and comments.

Example:

NOTE

Test results do not necessarily indicate a faulty component or system.

Important

IMPORTANT indicates a situation, which if not avoided, may result in damage to the test equipment or vehicle.

Example:

IMPORTANT

Do not soak scanner as water might find its way into the scanner.

2 Introduction

The latest Android tablet scanner i80 delivers faster and smarter diagnosis for workshops and technicians. Through hardware and software upgrades, technical staff can now approach problems with greater speed and accuracy and produce comprehensive, professional reports.

There are two main components:

- i80 Tablet - displays menus, test results and operation procedures and tips
- VCI Dongle - the device that communicates with the vehicle and transmits data the tablet

2.1 Scanner Descriptions

This section illustrates external features, ports and connectors of the scanner.

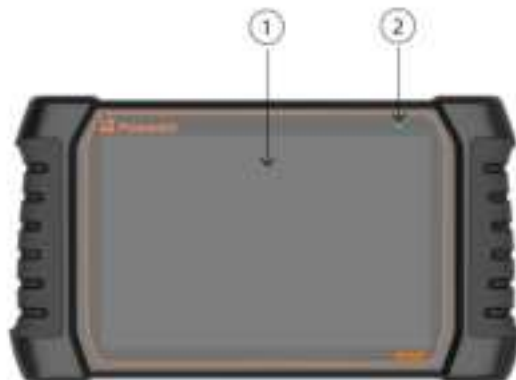

Figure 2-1Front View

1 10" LED IPS Capacitive Touch Screen - shows menus, test results and operation tips.

2 **Power Indicator** - indicates the power status of the scanner.

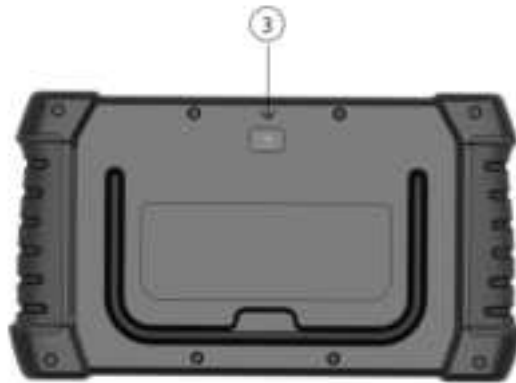

Figure 2-2 Back View

3 **Rear-Facing Camera** - takes pictures of VIN number, faulty parts and plates and shoots test videos.

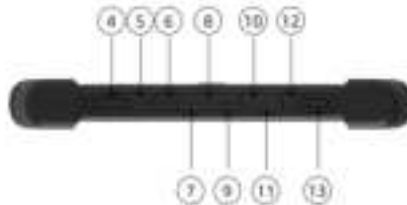

Figure 2-3 Top View

4 **VOL + / VOL -** - press to adjust the volume.

5 **Power Port** - connects to wall plug to charge the scanner.

6 **Ethernet Port** - connects with Ethernet cable.

7 **HDMI (high-definition multimedia interface) Port** - outputs display of the scanner for demonstration and training.

- 8 **USB Port** - provides USB connection with VCI dongle, oscilloscope, video scope and other external storage devices.
- 9 **USB Type-C Port** - be used to transfer data.
- 10 **TF Card Port** - inserts the TF card for extra space
- 11 **SIM Card Port** – inserts SIM card
- 12 **Headset Port**
- 13 **Power Switch** - turns on the scanner, goes to sleep mode or wake up the scanner from sleep mode, press and hold for 3 seconds for emergency shutdown.

IMPORTANT

Do not use solvents such as alcohol to clean display. Use a mild nonabrasive detergent and a soft cotton cloth.

2.2 VCI Dongle Descriptions

i80 connects to the vehicle and get data through the VCI dongle either by Bluetooth or USB communication.

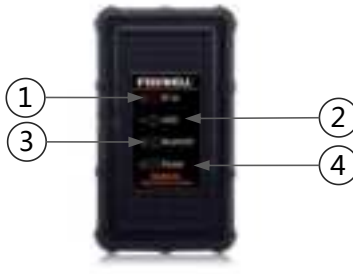

Figure 2-5 Front View of VCI dongle

- 1 **Error Light** - illuminates constantly when serious hardware failure occurs.
- 2 **USB Light** - turns green when the VCI dongle is properly connected and communicating with the i80 tablet via USB cable.
- 3 **Bluetooth Light** - turns green when the VCI dongle is properly connected with the i80 tablet via Bluetooth communication.
- 4 **Power Light** - turns to green when powered on.



Figure 2-6 Top View of VCI

5 Vehicle Data Connector - provides connection between vehicle and the VCI dongle through the 16 pin diagnostic cable.



Figure 2-7 Bottom View of VCI

6 USB Port - provides USB connection between the VCI dongle and i80 tablet.

2.3 Accessories

This section lists the accessories that go with the scanner. If you find any of the following items missing from your package, contact your local dealer for assistance.

 <p>i80 Main Unit</p>	 <p>VCI Dongle</p>	 <p>OBDII Adapter</p>	 <p>Diagnostic Cable</p>
 <p>Toyota 22 Pin Adapter</p>	 <p>Nissan 14 Pin Adapter</p>	 <p>Kia 20 Pin Adapter</p>	 <p>Mazda 17 Pin Adapter</p>
 <p>Toyota 17 Pin Adapter</p>	 <p>BMW 20 Pin Adapter</p>	 <p>Honda 3 Pin Adapter</p>	 <p>GM/Cummins 12 Pin Adapter</p>
 <p>Clip Cable / Lighter Fuse</p>	 <p>Cigarette Lighter</p>	 <p>Mitsubishi 12-24 Pin Adapter</p>	 <p>Mercedes-Benz 30 Pin Adapter</p>
 <p>Audi 4 Pin Adapter</p>	 <p>Ford 3 Pin Adapter</p>	 <p>PSA 2 Pin Adapter</p>	 <p>USB Cable for VCI</p>
 <p>AC/DC External Power Cord</p>	 <p>AC/DC External Power Adapter</p>	 <p>User's Manual</p>	 <p>Warranty/Quick Start Guide</p>

Table 2-1 Accessories

2.4 Technical Specifications

Item	Description
Touch Screen	10" diagonal, daylight readable color LCD screen, 1920*1200 pixel
Operation System	Android 8.1
Processor	RK3288 (ARM Cortex A17 x 4, 1.8GHz)
Memory	4GB LPDDR3
SSD Hard drive	64GB
System Type	Android 8.1
Communication interface	Built-in WIFI 802.11 b/g Wireless LAN USB2.0 OTG/standard USB 2.0 HOST Bluetooth 4.0 (10-20 m)
Camera	8 megapixels rear-facing
Built-in Battery	10000mAh, Lithium-polymer battery, chargeable via 12V/3A USB power supply
Protocols	ISO9141-2, ISO14230-2, ISO15765-4, K/L lines, Double K Line SAE-J1850 VPW, SAE-J1850PWM, CAN ISO 11898, High-speed, Middle-speed, Low-speed and Single wire CAN, KW81, KW82, GM UART, UART Echo Byte Protocol, Honda Diag-H Protocol, TP2.0, TP1.6, SAE J1939, SAE J1939, SAE J1708, Fault-Tolerant CAN
Dimensions	347*200*47mm (L*W*H)

Table 2-2 Technical Specifications

3 Getting Started

This section describes how to power on/off the scanner, provides brief introductions of applications loaded on the scanner and display screen layout of the scan tool.

3.1 Powering up the Scanner

Before using the i80 applications (including updating the scanner), please make sure to provide power to the scanner.

The unit operates on any of the following sources:

- Internal Battery Pack
- External Power Supply

3.1.1 Internal Battery Pack

The i80 tablet can be powered with the internal rechargeable battery. The fully charged battery is capable of providing power for 14 hours of continuous operation.

NOTE

Please turn off the tablet to save power when not use.

3.1.2 External Power Supply

The tablet can also be powered from a wall socket using the USB charging adapter. The tablet charges its internal battery pack through USB Type-C cable.

3.2 Shutting Down the Scanner

All vehicle communication must be terminated before shutting down the scanner. Exit the Diagnostic application before powering down.



Figure 3-1 Power-off Prompt Screen

- ▶ To shut down the scanner:
 1. Press and hold the Power button of the i80 for 5 seconds.
 2. Click the **Power off** to shut down or **Reboot** to restart.

3.3 Establishing Vehicle Communication

- ▶ To establish communication with i80:
 1. Connect the VCI dongle to the vehicle's DLC for both communication and power source.
 2. Connect the VCI dongle to the i80 tablet via Bluetooth or USB connection.



Figure 3-2 Sample Bluetooth Communication Screen

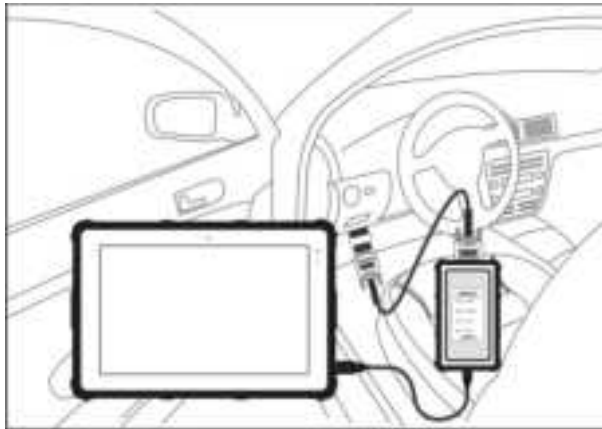

Figure 3-3 Sample USB Communication Screen

Please refer to **Chapter 3.3.1.1** about the details of how to connect via Bluetooth and **Chapter 3.3.1.2** about the details of how to connect via USB cable.

3. Check the VCI Indicator status at the toolbar. If the button turns to green, the i80 is ready to start vehicle diagnosis.

3.3.1 VCI Connection

The VCI dongle supports two ways of communication with the i80 tablet:

- Bluetooth Communication
- USB Communication

3.3.1.1 Bluetooth Communication

Bluetooth communication is recommended. The working range for Bluetooth communication is about 10-20m, providing easy connection to vehicles in any location throughout the shop.



-  To build Bluetooth connection:
1. Power up the tablet.
 2. Go to VCI Manager and then Bluetooth. Click Connect and the VCI dongle will connect to the tablet automatically.



Figure 3-4 Sample VCI Manager Screen



Figure 3-5 Sample Bluetooth Connection Screen

3. Check if the  button at the toolbar turns to green. If yes, it means it's ready to start diagnosis.



NOTE

If the VCI Indicator isn't green, it indicates that the signal strength of the transmitter is too weak to be detected. In this case, try to get closer to the device, or check the connection of VCI dongle, and remove all possible objects that cause signal interference

3.3.1.2 USB Communication

The USB connection is a simple and quick way to establish communication between the tablet and the VCI dongle. Connect the dongle and tablet with the USB Type B cable, and the VCI Indicator will turn green, indicating the dongle has connected to the tablet.

3.4 Screen Layout of Home Screen

When the tablet boots up, press the **i80** desktop icon to launch the diagnostic application.



Figure 3-7 Sample Home Screen

1. Application Menu
2. Navigation Toolbar

3.4.1 Application Menu



Figure 3-8 Sample Application Screen

This section briefly introduces the applications that are preloaded into the scanner:

- **Diagnostic** - leads to test screens for diagnostic trouble code information, live data, active tests, coding and etc.
- **Update** - leads to screens for Foxwell ID registration and updating the scanner.
- **Settings** - leads to screens for adjusting default settings to meet your own preference and view information about the scanner.
- **Remote Control** - leads to TeamViewer to get remote support from Foxwell team.
- **Maintenance** - leads to screens for the most commonly used service functions like Oil light reset, EPB, BRT, DPF and etc.
- **VCI Manager** - leads to screens for making Bluetooth pairing of VCI dongle and tablet, updating the VCI firmware and binding/unbinding VCI dongle
- **Technical Data** - provides access to repair data like HaynesPro.
- **Shop Manager** - allows the technicians to manage the workshop information and vehicle test records.
- **Data Manager** - leads to screens for saved screenshots, pictures and test reports, and playing back live data, as well as debug logging data..
- **My Account** - displays your Foxwell ID information like registered products and personal information and allows for sending us feedbacks about the scanner.
- **Function** - leads to screens to function query.

3.4.2 Navigation Toolbar

Operations of the buttons located on toolbar are described in the table below:









Name	Button	Description
Back		Back to the previous screen.
Home		Returns to Home screen of Android System.
Multitask		Allows for browsing, switching and closing active applications.
Camera		Takes a photo or picture.
Browser		Opens the built-in browser.
Screenshot		Captures screens.
VCI Indicator		Shortcut for VCI Manager menu from any screen of the tablet; also it is the indicator of Bluetooth/USB connection status.
Diagnostic		Shortcut for Diagnostic menu from any screen of the tablet.
Maintenance		Shortcut for Maintenance menu from any screen of the tablet.
Update		Shortcut for Update menu from any screen of the tablet.
Data Manager		Shortcut for Data Manager menu from any screen of the tablet.

Table 3-1 Tool Bar

3.4.3 Diagnostic Menu

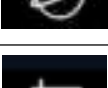
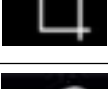
Touch **Diagnostic** at the i80 application menu, and the Diagnostic menu will display. The operations of the buttons on Diagnostic menu are described in the below table.



Figure 3-9 Sample Diagnostic Menu Screen

No.	Name	Description
1	Home	Back to the Application Menu.
2	VIN	Shortcut for VIN reading menu, which typically includes Automatic Read, Scan VIN and Manual Entry.
3	History	Displays the tested vehicle records.
4	Area	Displays car makes from different origins like America, Asia, Europe and Chinese.
5	Search	Lets you search a vehicle make quickly.

Table 3-2 Diagnostic Menu Title Bar

4 Vehicle Identification

This section illustrates how to use the scanner to identify the specifications of the vehicle under test.

The vehicle identification information presented is provided by the ECM of the vehicle being tested. Therefore, certain attributes of the test vehicle must be entered into the scan tool to ensure the data displays correctly. The vehicle identification sequence is menu driven. Simply follow the screen

prompts and make a series of choices. Each selection you make advances you to the next screen. Exact procedures may vary somewhat by vehicle.

It typically identifies a vehicle by any of the following means:

- VIN Reading
- Manual Selection
- History Records

NOTE

Not all identification options listed above are applicable to all vehicles. Available options may vary by vehicle manufacturer.

4.1 VIN Reading

VIN button  on the title bar is a shortcut for VIN reading menu, which includes Automatic Read, Scan VIN and Manual Entry, eliminating the need for navigating through complicated car identification process.



Figure 4-1 Sample VIN Hotkey Screen

4.1.1 Automatic Read

Automatic Read allows to identify a vehicle by automatically reading the vehicle identification number (VIN).



To identify a vehicle by Automatic Read:

1. Select **Diagnostic** from home screen of the i80 application.
2. Click **VIN** and choose **Automatic Read** from the option list.



Figure 4-2 Sample Automatic Read Screen

- When the scan tool builds connection with the vehicle, the VIN number displays. If the Vehicle Specification or VIN code is correct, press the **OK** to continue.



Figure 4-3 Sample Automatic Read Screen

- If it takes too long to get the VIN code, press **Cancel** to stop and input the VIN manually. Or if failed to identify the VIN, please input the VIN manually or click **Cancel** to quit.



4.1.2 Scan VIN

Scan VIN allows identifying a vehicle by scanning the VIN plate of the vehicle, barcode, QR code or photo recognition.

4.1.2.1 Scan VIN Plate

- ▶ To identify a vehicle by Scan VIN Plate:
1. Select **Diagnostic** from home screen of the i80 application.
 2. Click **VIN** button and choose **Scan VIN** from the option list.
 3. Find the VIN plate of your car, and put the VIN number into the scanning box. The VIN number displays with a successful scan. If the Vehicle Specification or VIN code is correct, press the **Confirm** to continue. If incorrect, you are allowed to modify VIN number manually.



Figure 4-5 Sample Scan VIN Screen



Figure 4-6 Sample VIN Confirmation Screen



Figure 4-7 Sample Modify VIN Screen

4. If failed, please click **Close** to quit and input the VIN manually.

4.1.2.2 Scan Barcode/QR Code of VIN

- ▶ To identify a vehicle by **Scan QR Code**:
 1. Select **Diagnostic** from home screen of the i80 application.
 2. Click **VIN** button, choose **Scan VIN** from the option list and enable **Scan QR Code** at the lower left part of the screen.



Figure 4-8 Sample Scan QR Code Screen

3. Find the VIN QR code or bar code of your car, and put the code into the scanning box. The VIN number displays with a successful scan. If the Vehicle Specification or VIN code is correct, press the **Confirm** to continue. If incorrect, you are allowed to modify VIN number manually. The scan box can be zoomed in or zoomed out.



Figure 4-9 Sample Scan QR Code Screen



Figure 4-10 Sample VIN Confirmation Screen

4. If failed, please click Close to quit and input the VIN manually.

4.1.2.3 Photo Recognition

▶ To identify a vehicle by **Photo Recognition**:

1. Select **Diagnostic** from home screen of the i80 application.
2. Click **VIN** button and choose **Scan VIN** from the option list.
3. Find the VIN plate, QR code or barcode of your car, and put the content number into the scanning box. Then click **Photo Recognition** button on the lower middle screen. The VIN number displays with a successful scan. If the Vehicle Specification or VIN code is correct, press the **Confirm** to continue. If incorrect, you are allowed to modify VIN number manually.



Figure 4-11 Sample Photo Recognition Screen



Figure 4-12 Sample VIN Confirmation Screen



Figure 4-13 Sample Modify VIN Screen

4. If failed, please click **Close** to quit and input the VIN manually.

4.1.3 Manual Entry

Manual Entry allows to identify a vehicle by inputting VIN manually.

- ☑ To identify a vehicle by Manual Entry:

1. Select **Diagnostic** from home screen of the i80 application.
2. Click **VIN** and choose **Manual Entry** from the option list.
3. Press Keyboard button to input a valid VIN code and press OK to continue.



Figure 4-14 Sample Manual Entry Screen

4.2 Manual Selection

Select vehicle brand you are to test, and two ways of getting to the diagnostic operations are available.

- Smart VIN
- Manual Selection



Figure 4-15 Sample Vehicle Entry Screen

Name	Button	Description
Home		Back to the Application Menu.





Settings		A shortcut for Settings menu.
Data Logging		Records the communication data between the scan tool and the vehicle to help with troubleshooting of diagnostic failures.
Print		Print the test data and report.
Screenshot		Takes screenshot of test data or report and save them for later analysis.

Table 4-1 Title Bar

4.2.1 Smart VIN

Smart VIN allows to identify a vehicle by automatically reading the vehicle identification number (VIN).

 To identify a vehicle by Smart VIN:

1. Select **Diagnostic** from home screen of the i80 application.
2. A screen with vehicle manufacturers displays. Select the area where the vehicle manufacturer from. A menu of all vehicle manufacturers displays. Or tap the **Search** box to search the car you are to test.



Figure 4-16 Sample Vehicle Selection Screen

3. Choose **SmartVIN** option to start reading the VIN automatically.



Figure 4-17 Sample Smart VIN Screen

4. After the scan tool builds connection to the vehicle, the VIN number displays. If the Vehicle Specification or VIN code is correct, press the **OK** to continue. If incorrect, please enter a valid VIN number manually.

4.2.2 Manual Vehicle Selection

Manual Selection identifies a vehicle by making several selections according to certain VIN characters, such as model year, and engine type.

-  To identify a vehicle by manual vehicle selection:
1. Select **Diagnostic** from home screen of the i80 application.
 2. A screen with vehicle manufacturers displays. Select the area where the vehicle manufacturer is from. A menu of all vehicle manufacturers displays. Or tap the **Search** box to search the car you are to test.
 3. Choose **Manual Selection** option from the list.
 4. On each screen that appears, select the correct option until the complete vehicle information is entered and the menu of controller selection displays.



Figure 4-18 Sample Manual Vehicle Selection Screen

4.3 Vehicle History

Vehicle History keeps records of tested vehicles and allows restarting the diagnosis of a vehicle without the need to do vehicle identification again.

-  To identify a vehicle by Vehicle History:
1. Select **Diagnostic** from home screen of the i80 application.
 2. Select **History** button at the top of the diagnostic page and the diagnostic records will display.



Figure 4-19 Sample History Record Screen

3. Choose the vehicle model you want to test from the list.
4. Click the Diagnostic  button at the tested vehicle information page and then answer **Yes** to go to system selection page.



Figure 4-20 Sample History Record Screen

5 Diagnosis

This section illustrates how to use the scanner to read and clear diagnostic trouble codes, view live data readings and ECU information on controllers installed, perform special functions such as actuation and coding, and perform vehicle services and maintenance on Asia, European and USA vehicle brands.

When you have completed the identification of vehicle, the main menu displays. Menu options typically include:

- Diagnosis
- Special Functions



Figure 5-1 Sample Main Menu Screen

5.1 Control Module Selection

When you completed the identification of vehicle, you have to identify the control modules installed in the vehicle. There are two ways to identify the controllers installed in a car:

- Quick Scan
- Control Modules



Figure 5-2 Sample Diagnosis Screen

5.1.1 Quick Scan

Quick Scan performs an automatic system test to determine which control modules are installed on the vehicle and provides diagnostic trouble codes (DTCs) overview. Depending on the number of control modules, it may take a few minutes to complete the test.



To perform an automatic system scan:

1. Press **Quick Scan** option to start.
2. To pause the scan, press the **Pause** button on the screen.



Figure 5-3 Sample Quick Scan Screen

3. At the end of successful automatic controller scan, a menu with a list of **DTC** displays and click  button to the right to view DTC descriptions.



Figure 5-4 Sample Quick Scan Complete Screen

4. Press **Report** to create an overview of installed control units and their system status, or press **Save** to save the report. Press **Erase** to clear the information.



Figure 5-5 Sample DTC Save Screen



Figure 5-6 Sample Report Screen



Figure 5- 7 Sample Erase Screen

5. When running auto scanning, you can press **Pause** and select the system you would like to test. When the scanner has established connection with the vehicle, the Function Menu displays.



Figure 5-8 Sample Function Menu Screen

5.1.2 Control Modules

Control Modules displays all controllers available of the vehicle manufacturer. The controllers listed on the menu do not mean that they are installed on the vehicle. It is useful for technicians who are familiar with the vehicle specifications.

- ▶ To select a system to test:
 1. Press **Control Modules** from the menu and a controller menu displays.



Figure 5-9 Sample Control Modules Screen

2. Select a system to test. When the scanner has established connection with the vehicle, the **Function Menu** displays.



Figure 5-10 Sample Function Menu Screen

5.2 Diagnostic Operations

After a system is selected and the scanner establishes communication with the vehicle, the Function Menu displays. Generally the menu options are:

- Read Codes
- Clear Codes
- Live Data
- Active Test
- ECU Information
- Special Functions

NOTE

Not all function options listed above are applicable to all vehicles. Available options may vary by the year, model, and make of the test vehicle.

5.2.1 Read Codes

Read Codes menu lets you read trouble codes found in the control unit. There are 4 types of code status:

- Present/Permanent/Current
- Pending
- History
- Self-diagnostic

Present/Permanent/Current codes stored in a control module are used to help identify the cause of a trouble or troubles with a vehicle. These codes have occurred a specific number of times and indicate a problem that requires repair.

Pending codes are also referred to as maturing codes that indicate intermittent faults. If the fault does not occur within a certain number of drive cycles (depending on vehicle), the code clears from memory. If a fault occurs a specific number of times, the code matures into a DTC and the MIL illuminates or blinks.

History codes are also referred to as past codes that indicate intermittent DTCs that are not currently active. Code history is number of engine starts since DTC(s) were first detected (to see if they are current or intermittent).

Self-diagnostic lets you manually activate system tests that check for DTCs. Usually it includes a KOEO (Key-on, engine-off) test and a KOER (key-on, engine-running) test.



-  To read codes from a vehicle:
1. Press **Read Codes** from Select Diagnostic Function menu. A code list including code number and its description displays. The red icon  means there is help information available for the code. The green icon  means there is freeze frame available.



Figure 5-11 Sample Trouble Code Screen

- **Freeze Frame**- select one fault code from the code list and click **Freeze Frame** button on the screen. The screen will display freeze frame data, a

snapshot of critical vehicle operating conditions automatically recorded by the on-board computer at the time of the DTC set. It is a good function to help determine what caused the fault.



Figure 5-12 Sample Trouble Code Screen





Figure 5-13 Sample Freeze Frame Screen

- **Help** - select one fault code from the code list and click **Help** button on the screen. The screen will display the detailed descriptions about the fault code and repair guide.



Figure 5-14 Sample DTC Help Screen

2. Slide up and down to view additional information when necessary.
3. Press **Save** to store DTC information. Press  to print the information if need be. Press  to exit.

5.2.2 Clear Codes

Clear Codes menu lets you to clear all current and stored DTCs from a selected control module. Also it erases all temporary ECU information, including freeze frame, so make sure that the selected system is completely checked and serviced by technicians and no vital information will be lost before clearing codes.

NOTE

- To clear codes, make sure that the ignition key is switched to ON with the engine off.
- Clear Codes does not fix the problem that caused the fault! DTCs should only be erased after correcting the condition(s) that caused them.



To clear codes:

1. Press **Clear Codes** from Select Diagnostic Function menu.



Figure 5-15 Sample Function Menu Screen

2. Follow the on-screen instructions and answer questions about the vehicle being tested to complete the procedure.
3. Check the codes again. If any codes remain, repeat the Clear Codes steps.

5.2.3 Live Data

Live Data menu lets you view real time PID data in text and plot formats, learn good sensor data and compare them with faulty data, and record live data from a selected vehicle electronic control module.

Menu options typically include:

- All Data
- Custom List

5.2.3.1 All Data

All Data menu lets you view all live PID data from a selected control module.

-  To view all live PID data:
1. Press **Live Data** from Select Diagnostic Function menu to display the live data menu.



Figure 5-16 Sample Function Menu Screen

2. Press **All Data** from the menu to display the data stream screen. All readings will be displayed in text format by default.



Figure 5-17 Sample Live Data Screen







Name	Button	Description
Help		To provide help information of a PID
To Top		To move a data line to the top of Data List screen
History		To view the previous live data records or test reports
Record		To make record of live data
Save		To save live data of current frame
Pause		To stop recording live data

Table 5-1 Live Data Screen Button Screen

- Learn Mode:** gives you the ability to learn good live sensor data values during idle, KEKO, acceleration, deceleration, part load and heavy load on each vehicle comes into your shop and records them for future reference. Click the dropdown list at the upper left of the screen to enter to choose a working condition to learn.



Figure 5-18 Sample Learn Mode Screen

- **Compare Mode** - If that vehicle comes in is with a problem, you can easily compare the faulty sensor and parameter readings to the good readings, and you will be alarmed when a faulty sensor reading is detected.

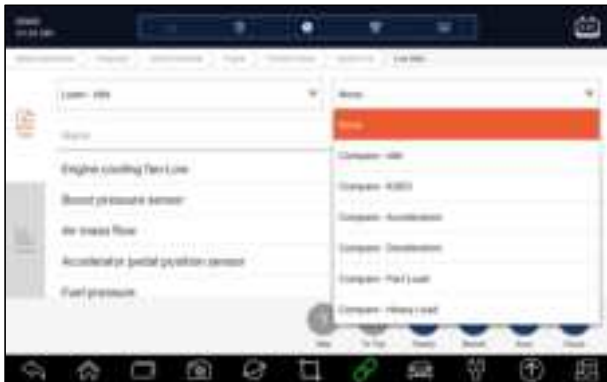

Figure 5-19 Sample Live Data Screen

3. Swipe the screen up and down to view additional information when necessary.
4. To move a data line to the top of Data List screen, just tap the line to select and then press the button **To Top**. To view data records or test reports, and press the button **History**. To make records of live data, just tap the button **Record**, and press **Pause** to stop recording at any time. To save the data, tap the **Save** icon.
5. To view live PID in graph format, press the tab Graph, and the plot displays. To view another PID plot, tab the name of a plot and a list of available PIDs display. Select one from the dropdown box and the plot changes to the newly selected PID.



Figure 5-20 Sample PID Graph Screen

- **Multi-graphs:** displays the parameters in waveform graphs, giving you the 'real picture' of what's going on in the vehicle. You can view up to 4 parameter graphs simultaneously.



Figure 5-21 Sample Multi-graphs Screen

- **Merge Graph:** merges multiple PID plots into one coordinate, so you can easily see how they affect each other, providing you with the most comprehensive and functional look at live data possible.



Figure 5-22 Sample Merge Graph Screen

5.2.3.2 Custom List

Custom List menu lets you to minimize the number of PIDs on the data list and focus on any suspicious or symptom-specific data parameters.

- ▶ To create a custom data list:
 1. Press **Custom List** from the menu to display all available parameters from the selected control module.
 2. The custom data stream selection screen displays. Tap the lines you wish to select.
 3. To deselect an item, tap the line again. Alternatively, tap **SELECT ALL** or **CLEAR ALL** to select or deselect all items at once.



Figure 5-23 Sample Custom List Selection Screen

4. Press **OK** to complete the selection, and all selected parameters display.



Figure 5-24 Sample Live Data Screen

5.2.4 ECU Information

ECU Information screen displays the identification data of the control module under test, such as the control module identification string and the control module coding.

- ▶ To read ECU information:

1. Press **ECU Information** from Select Diagnostic Function menu.





Figure 5-25 Sample Function Menu Screen

2. A screen with detailed information of the selected control module displays.



Figure 5-26 Sample ECU Information Screen

3. Press **Save** to store ECU information. Press  to print the information if need be. Press  to exit.

5.2.5 Active Tests

Active Tests, also known as Actuator Tests, are bi-directional diagnostic tests on vehicle systems and component. The tests let you to use the scanner temporarily activate or control a vehicle system or component, and when you exit the test, the system/component returns to normal operation.

Some tests display a command to the operator. For example, if “Press Brake Pedal” displays, the operator has to press and hold the brake pedal and then continue. The sequence, number and type of tests are dictated by the control module.

On some systems, the actuator tests cannot be restarted until the ignition key is switched off for some time. Alternatively, briefly start and run the engine,

shut down, turn the ignition to the run position, then re-initiate the actuator tests.

IMPORTANT

The tests activate a component, but they do not check if the component is working correctly. Make sure the components to be tested are in good condition and correctly mounted.

NOTE

Available tests depend on the control module under test and the vehicle itself.



To start a test:

1. Press **Active Test** from the menu and a list of available options displays.



Figure 5-27 Sample Function Menu Screen

2. Select an option to start the test and live data of the selected test displays.



Figure 5-28 Sample Active Test Screen

3. Follow on-screen instructions to make proper selections and operations to complete the tests.
4. Press  to exit.



- Before running any tests, always observe the safety instructions provided in this manual and the warnings provided by the vehicle manufacturer. In addition, follow any warnings and descriptions provided on the scanner screens.
- Never run the tests while the vehicle is moving.

5.2.6 Special Functions

These functions perform various component adaptations of the control module under test, allowing you to recalibrate or configure certain components after making repairs or replacement.

5.3 Special Functions

These functions perform various component adaptations, allowing you to recalibrate or configure certain components after making repairs or replacement. Typical service operation screens are a series of menu driven executive commands. Follow on-screen instructions to complete the operation.

Generally the menu options are:

- Service
- Programming
- Hot Function

5.3.1 Service

The **Service** section is specially designed to provide you quick access to the vehicle systems for various scheduled service and maintenance performances.

-  To start a service function:
1. Select **Special Functions** from main menu and press **ENTER** to confirm.



Figure 5-29 Sample Main Menu Screen

2. Select **Service** option from the Special Functions menu. A list of available services display.



Figure 5-30 Sample Special Functions Screen

3. Select the service you want to perform. Follow on-screen instructions to make proper selections and operations to complete the tests.



Figure 5-31 Sample Service Function Screen

5.3.2 Coding and Programming

i80 allows for the coding and programming of a replacement control module or changing previously stored incorrect coding.

Coding also is known as Teach-in Program or Component Adaptation. It is the process of selecting and activating one program for a specific vehicle from a set of programs that the factory installed in the control module. This allows one control module to be used for different models, countries, and emission applications.

Programming is the process of taking a blank control module and then adding the correct vehicle program to memory.



To start a coding & programming test:

1. Select **Special Functions** from main menu and press **ENTER** to confirm.



Figure 5-32 Sample Main Menu Screen

2. Select **Programming** option from the Special Functions menu. A list of available services display.



Figure 5-33 Sample Special Functions Screen

3. Select the function you want to test. Follow on-screen instructions to make proper selections and operations to complete the tests



5.3.3 Hot Functions

It is designed for most common used functions like battery configuration, oil light reset and provides quick access to service functions for the technicians.

 To start a test:

1. Select **Special Functions** from main menu and press **ENTER** to confirm.



Figure 5-35 Sample Main Menu Screen

2. Select **Hot Functions** option from the Special Functions menu. A list of available services display.



Figure 5-36 Sample Special Functions Screen

3. Select the function you want to test. Follow on-screen instructions to make proper selections and operations to complete the tests



Figure 5-37 Sample Hot Functions Screen

6 Maintenance

This section gives brief instructions of the most commonly required service and maintenance operations. Typical service operation screens are a series of menu driven executive commands. Follow on-screen instructions to complete the operation.

Available service and maintenance options include:

- Oil Light Reset
- EPB Service
- Battery Configuration
- DPF Regeneration
- TPS/TBA
- SAS Calibration
- CVT
- Gear Learn
- TPMS Relearn
- Odometer
- Injector coding
- ABS Bleeding
- Key Programming/Immobilizer

6.1 Oil Light Reset

Oil Light Reset menu allows you to reset the service lamps on the instrument cluster. The Service Indicator System is designed to alert the driver when the vehicle is due for a service.

Oil service reset methods are determined by the vehicle being tested. Depending on the vehicle being tested, any of the following means displays:

- **Oil Reset with One Button** - applicable to GM models only. It offers quick and simple oil service reset with the click of one button.
- **Manual Reset** - almost all Asian vehicles and most American and European vehicles have mechanical oil service indicator reset. The service tool does not have to communicate with the vehicle being tested, but guides you to complete the service manually by providing step-by-step on-screen instructions.
When Manual Reset is selected and the vehicle being tested identified, a procedure opens on the screen. Scroll with arrow keys to read the entire procedure and performing the necessary steps as directed by the on-screen instructions. The exact order of the test operation steps may vary depending on the test vehicle. Be sure to follow all on-screen instructions. The manual reset procedure can be interrupted and aborted if the ignition key position is changed.
- **Auto Reset** - Auto Reset is a bi-directional communication procedure directed by the service tool. The service tool displays guides for you through the process. A number of instructions that require a response to continue display, including an option to clear any stored codes once the interval has been reset. Follow the on-screen instructions.

6.2 Electronic Parking Brake (EPB) Service

EPB Service menu allows you to perform the service and maintenance of brake systems, including deactivation and activation of the brake control system, bleeding brake fluid, opening and closing brake pads, and setting brakes after disc or pad replacement, on multiple brands of vehicles where electronic brake systems are fitted.

Some tests display a command to the operator. For example, if “Pressing Brake Pedal” displays, the operator has to press and hold the brake pedal and then continue. Actual tests vary by vehicle manufacturer, year, make.

Typical special test options include:

- **Deactivate/Activate SBC/EPB systems** - allows to deactivate brakes for further service or maintenance work on brake systems or activate brakes when service or maintenance work on brake systems are completed.
- **Adaptation on Audi A8** - allows to set new pad thickness of rear brakes calipers after changing brake discs & pads on Audi A8 models.
- **Replace hydraulic brake systems fluid/bleed brake system on Mercedes SBC vehicles** - allows to change brake fluid/bleed brake system.
- **Perform service reset and service position on BMW EPB vehicles** - allows to do the CBS reset and CBS correction for front brake and rear brake.

- **Perform activation/service work on Volvo PBM vehicles** – allows to perform installation check, applying parking brake, releasing parking brake, activating service mode and exiting service mode.
- **Reset memory on Toyota EPB vehicles** – allows to clear the learned memory of the EPB ECU.
- **Perform brake cable replacement and electric parking brake replacement** – allows to fit in or remove the brake cable safely, adjust brake cable's tension and calibrate the electric parking brake replacement.
- **Save and write clutch pedal programming on Renault EPB vehicles** – allows to save clutch pedal programming on Renault vehicles fitted with manual gearbox. After this command is activated, the tool allows to "flash" the electric parking brake unit with the saved clutch data.
- **Perform control function and reset function on Opel EPB vehicles** - allows to apply/release park brake cable service, provides park brake cable service replacement procedures and calibrate the parking brake systems after brake service.
- **Sensor calibration on Honda EPB vehicles** - allows to program the current output value of each sensor into the electric parking brake unit.
- **Provides parking brake unjam procedure and perform longitudinal accelerometer calibration on Land Rover EPB vehicles** - allows to drive the electronic park brake so it is unjammed in the releasing direction and then drive it into mounting position or the latching position; also allows to perform longitudinal accelerometer calibration.

WARNING

- EPB systems must be deactivated before carrying out any maintenance/service work on the brakes such as changing of pads, discs and calipers.
- Use proper tools to avoid the risk of body injuries of mechanics and technicians and damage to the brake system.
- Make sure the vehicle is properly blocked after deactivation of the systems.

6.3 Battery Replacement (BRT)

BRT menu lets you to validate new battery, clear faults from the dashboard and display current battery details of the vehicle such as Audi, BMW, Citroen, Peugeot, Seat, Skoda, Volvo, VW and Ford.

1. Replace the old battery with the new one. Ensure the key is not in the ignition.
2. Connect the scanner to the vehicle's 16 pin Data Link Connector (DLC) with the diagnostic cable.

3. Boost the device and select BRT; it will display all the vehicle makes available. Choose your vehicle make and follow the scanner instruction to start.
 - **Sensor calibration on Honda EPB vehicles** - allows to program the current output value of each sensor into the electric parking brake unit.
 - **Perform BRT on Citroen/Peugeot cars** – make several selections to confirm your car model, and then complete the battery replacement following on-screen instructions.
 - **Perform BRT on Audi/VW/Seat/Skoda cars** - after communicating with vehicles, there's two options under Replace battery menu - **Validate battery** and **Display data**.
 - **Validate battery** menu lets you to recode the new battery to the vehicle's ECU and to turn off dashboard warning lights. The on-screen instructions would guide you step by step to complete the replacement.
 - **Display Data** menu lets you to check the battery information or battery replacement records
 - **Perform BRT on BMW/Volvo cars** - after making several selections to confirm your vehicle model, you can select **Display data**, **Validate Battery** or **Clear codes** from Function menu.

6.4 Diesel Particulate Filter (DPF) Regeneration

DPF Regeneration menu let you perform the DPF cleaning to clear the blockage through continuous burning of the particulates captured in the DPF filter. When a DPF regeneration cycle is completed, the DPF light automatically goes off.

6.5 Throttle Body Alignment (TPS/TBA)

It's very common to see a customer pull into the shop with a Volkswagen or Audi that just will not idle correctly. One of the possible causes is that the throttle position is not known. When the motion range is not known, the ECU simply has no idea where to set the throttle. The ECU must know the full range of motion of the throttle in order for it to properly control the engine. Using the throttle position sensors in the throttle body, the ECU learns the full open and full closed positions through various states (idle, part throttle, WOT) known as a Throttle Body Alignment (TBA).

6.6 Steering Angle Sensor (SAS) Calibration

SAS Calibration menu let you perform calibration of the Steering Angle Sensor, which permanently stores the current steering wheel position as straight-ahead in the sensor EEPROM. On successful calibration of the sensor, its fault memory is automatically cleared.

6.7 Continuous Variable Transmission (CVT)

This function is used to reset the compensation code and initialize the ECT after a solenoid valve or valve body assembly has been replaced.

6.8 Gear Learning

The crankshaft position sensor learns crankshaft tooth machining tolerance and saves to the computer to more accurately diagnose engine misfires. If tooth learning is not performed for a car equipped with Delphi engine, the MIL turns on after the engine is started. The diagnostic device detects the DTC P 1336 'tooth not learned'. In this case, you must the diagnostic device to perform tooth learning for the car. After tooth learning is successful, the MIL turns off.

After the engine ECU, crankshaft position sensor, or crankshaft flywheel is replaced, or the DTC 'tooth not learned' is present, tooth learning must be performed.

6.9 TPMS Relearn

After the tire pressure MIL turns on and maintenance is performed, the tire pressure resetting function must be performed to reset tire pressure and turn off the tire pressure MIL.

6.10 Odometer

This function allows you to revise the date of odometer and write the original date into new odometer.

6.11 Injector Coding

Write injector actual code or rewrite code in the ECU to the injector code of the corresponding cylinder so as to more accurately control or correct cylinder injection quantity. After the ECU or injector is replaced, injector code of each cylinder must be confirmed or re-coded so that the cylinder can better identify injectors to accurately control fuel injection.

6.12 ABS Bleeding

Anytime the brake system is opened to replace components such as calipers, wheel cylinders, the master cylinder, or brake lines or hoses, air gets inside. The air has to be removed by bleeding the brakes if you want a firm brake

pedal. Air trapped in the lines, calipers or wheel cylinders will make the pedal feel soft and spongy. Air is compressible, so when the brakes are applied any air bubbles in the system must first be compressed before the hydraulic fluid will transmit pressure to apply the brakes.

6.13 Key Programming/Immobilizer

The transponder key is an aftermarket option that can be programmed for a number of vehicles. Also known as a chip key or ignition key, this key offers a level of convenience and security for your car. If your car is equipped with a chip key system, only a programmed key can turn on the ignition in your vehicle.

7 Data Manager

Data Manager menu let you review stored screenshots and test reports, playback recorded live data and other saved files.

Typical menu options include:

- Image
- PDF
- Data Playback
- Data Record



Figure 7-1 Sample Data Manager Screen

7.1 Image

Image option leads to screens for review of stored screenshots. In case a failure of i80 application or the Android system occurs, please just take a screenshot and send it to our team to help with the troubleshooting.

7.1.1 How to Save an Image

 To take a screenshot:

1. If want to save data of current screen, press  at the title bar to take a screenshot.



Figure 7-2 Sample Screenshot Screen

2. Add a description of the image, and press the **OK** to save.



Figure 7-3 Sample Screenshot Screen

7.1.2 Review Image

 To review the screenshots:

1. Press **Data Manager** from home screen of i80 diagnostic application.
2. Press **Image** and all available pictures will be displayed.



Figure 7-4 Sample Browse Picture Screen

3. To delete a picture, tap button **Delete** and answer **OK** to delete. Press **Print** to print the pictures and press **Rename** to change the picture name.



Figure 7-5 Sample Edit Picture Screen

4. Long press the screen to edit all pictures like **Rename** or **Delete**.



Figure 7-6 Sample All Pictures Edit Screen

7.2 PDF Report

PDF option leads to screens for review of the vehicle test reports. You just need to press the PDF icon on the test screen, add a description and press **OK** button to save.

7.2.1 How to Create a PDF Report

- ▶ To create a PDF report:
 1. If need be, press the **Save** icon on the test screen to save the data.



Figure 7-7 Sample of DPF Screen

2. Add a description to the DPF report, and press the **OK** to save.

7.2.2 Review PDF Report

- ▶ To review the PDF reports:
 1. Press **Data Manager** from home screen of i80 diagnostic application.
 2. Press **PDF** and all available PDF files will be displayed.



Figure 7-8 Sample Browse PDF Screen

3. Long press the screen to edit all PDF files like **Rename** or **Delete** the files.



Figure 7-9 Sample Edit PDF Screen

7.3 Data Playback

The **Data Playback** option leads to screens for review of recorded live data. Playing back a recording is just like using the scan tool on a live vehicle. It let you review live data in text, graph and graph merging formats. Playback speed and direction (forward or reverse) can also be controlled.

-  To review recorded live data:
1. Press **Data Manager** from home screen of i80 diagnostic application.
 2. Press **Data Playback** and all available records display.
 3. Select one record and press **Select All** button or choose some parameters, then press the **OK** button to review. All recorded parameters display in text format by default.



Figure 7-10 Sample Data Playback Screen

4. To view parameter graphs, press the **Graph** tab. And to merge the graphs, press the tab **Merge Graph** or press the tab **Multi Graph** to view multiple plots.



Figure 7-11 Sample Graph Screen

5. To move forward or reverse back of the playing, just drag the progress bar forward or reverse. To stop, press the **Pause** button.



Figure 7-12 Sample Edit Data Playback Screen

6. Long press the record to Rename or Delete the records.

7.4 Data Logging & Data Record

Data Logging collects the communication data between the scanner and the vehicle under test to help with troubleshooting of diagnostic failures. The logs will be saved to the tablet. The logging icon  displays on the title bar of the diagnostic screen whenever the scanner builds communication with the vehicle.

-  To create a debug data log:
 1. When connected to a car, click the Data Logging icon to start record the communication data between the tablet and the vehicle.



Figure 7-13 Sample Data Logging Screen

2. Click the Data Logging icon again to stop the recording and data log record will be saved automatically.
3. Go to **Data Manager -- Data Record** to view the stored logs.

8 VCI Manager

VCI Manager allows you to make Bluetooth pairing between the tablet and the VCI dongle, update VCI firmware and unbind a VCI dongle.



Figure 8-1 Sample VCI Manager Screen

8.1 Bluetooth

During the Bluetooth pairing process, make sure the VCI dongle is correctly powered by either connected to a vehicle or connect to the tablet with the USB Type-B cable.

-  To make Bluetooth pairing of the VCI dongle and the tablet

1. Connect the VCI dongle with a vehicle via diagnostic cable or connect to the tablet with the USB Type-B cable.
2. Click the **VCI Manager** application on the i80 Menu.
3. Select **Bluetooth** option from the list.
4. Select the right device with the i80 serial number from the list.
5. When pairing is successfully done, the status is shown as Paired.
6. Wait a few seconds, and the  button at the toolbar illuminates green, indicating the tablet is connected to the VCI dongle via Bluetooth.

NOTE

A VCI dongle can be paired with ONE tablet each time.

8.2 Update Firmware

Update option allows you to update VCI firmware when the new version is available.

-  To update the VCI dongle firmware:
1. Connect the VCI dongle to the i80 tablet via USB or Bluetooth. And make sure the power supply will not be disturbed during the process of update.
 2. Click the **VCI Manager** application on the i80 menu.
 3. Select **Update** option from the option list.
 4. It will start the update automatically. If update failed, please follow the on-screen instructions to troubleshoot and repeat the process.



Figure 8-2 Sample VCI Updating Screen

NOTE

If there is a firmware update available, the update file will be saved automatically when you try to update the diagnostic software of a vehicle. And you will be prompted to upgrade the firmware.



Figure 8-3 Sample Update Prompt Screen

8.3 Unbind a VCI dongle

This option allows you to unbind a VCI dongle when the VCI dongle is defective or stolen.

▶ To unbind a VCI dongle:

1. Click the **VCI Manager** application on the i80 Menu.



Figure 8-4 Sample VCI Manager Screen

2. Select **Unbind a VCI dongle** option from the option list and press **OK** to confirm.



Figure 8-5 Sample Unbind Prompt Screen

▶ To bind a new VCI dongle:

1. Connect the VCI dongle with i80 tablet via USB cable.

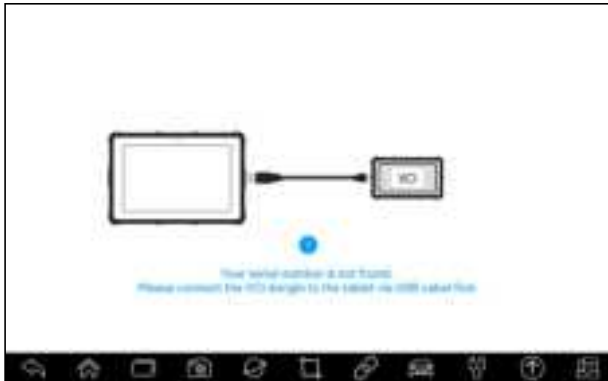

Figure 8-6 Sample Bind Prompt Screen

2. When system database initialization finished, you can use the tablet normally.



9 Registration and Update

The scanner can be updated to keep you stay current with the latest development of diagnosis. This section illustrates how to register and update your scan tool. You can register both on Foxwell website or by the built-in update client.

NOTE

Before registration and updating, please make sure your network works correctly and the tablet is fully charged or connect to external power supply.

9.1 Registration

If you are new to FOXWELL, please get a FOXWELL ID first either by

- Registering with the built-in update client;
- Or registering through our website with the URL:
<http://www.foxwelltech.us/register.html>

9.1.1 Register with Built-in Update Client

You are allowed to create a Foxwell ID with the built-in update client.

- ▶ To register with built-in update client:
1. Press **Update** from home screen of i80 diagnostic application, and the update client starts up automatically.



Figure 9-1 Sample Update Client Main Screen

2. Click **Free Registration** button, and the registration window will pop up.



Figure 9-2 Sample ID Registration Screen

3. Enter one of your email addresses as your user ID and click the **Send Code** button. We will send a 4-digit verification code to the email you just entered. Find the security code in your mailbox, input the code, create a password and click **Free Registration** to complete.



Figure 9-3 Sample ID Registration Screen

4. “The account has been created successfully” message will appear if you registered successfully.

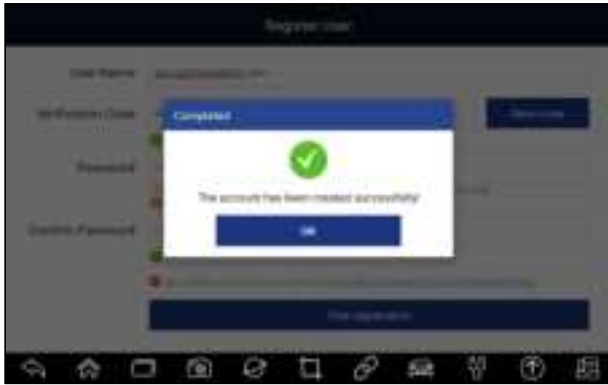

Figure 9-4 Sample Registration Done Screen

5. The serial number will be recognized automatically and click **Submit** to activate the scanner.



Figure 9-5 Sample Product Activation Screen

6. The product is registered successfully.

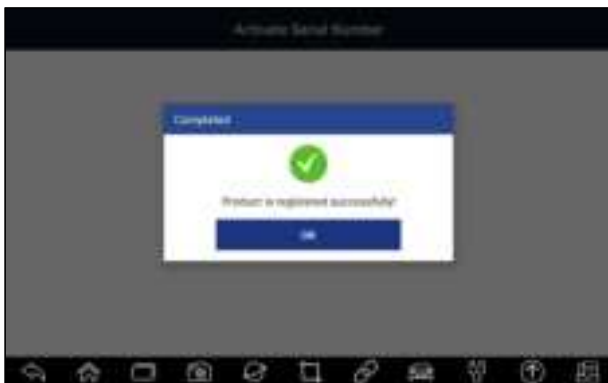

Figure 9-6 Sample Activation Done Screen

9.1.2 Register through Website

To register through our website:

1. Visit Foxwell official website www.foxwelltech.us and press **Register** icon, or go to the registration page by selecting **Support** from home page and then click **Register**.



Figure 9-7 Sample Website Register Screen



Figure 9-8 Sample Website Register Screen

2. Enter one of your email addresses as your user ID and click the **Send Code** button. We will send a 4-digit verification code to the email you just entered. Find the security code in your mailbox, input the code, create a password and click Free Registration to complete.

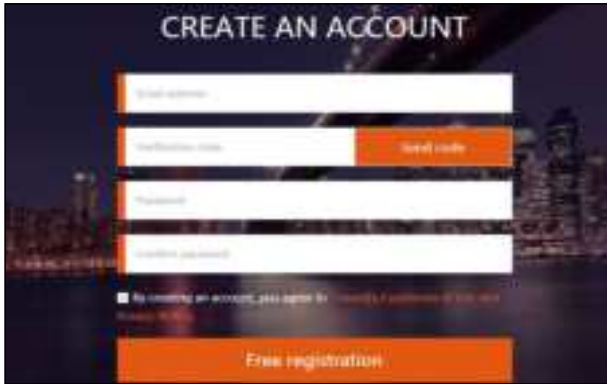

Figure 9-9 Sample Create Account Screen

3. Sign in to the **Member Center**, click **New Registration**, input the right serial number and click **Submit** to activate the product.



Figure 9-10 Sample Product Register Screen

9.2 Update

 To update the diagnostic application:

1. Press **Update** from home screen or press update shortcut  at the tool bar, and the update client starts up automatically.
2. The available updates display. Click the check box(s) in front of the software you wish to update and then click the **Update** button to download.
3. When all the items are updated, an “Update Done” message displays.

NOTE

Please make sure your network works correctly and the tablet is fully charged or connect to external power supply.



Figure 9-11 Sample Update Screen

10 Settings

This section illustrates how to program the scanner to meet your specific needs.

When Settings application is selected, a menu with available service options displays. Menu options typically include:

- Unit
- Language
- Push Message
- Automatic Update
- System Settings
- General
- Uninstall Vehicle Software
- Print Settings
- About

10.1 Change Units

Selecting **Unit** opens a dialog box that allows you to choose between Imperial customary or metric units of measure.

 To change the unit setup:

1. Press **Settings** from home screen of the i80 diagnostic application.
2. Press **Unit** and available unit system display.
3. Select a unit system.

10.2 Language

Select **Language** opens a screen that allows you to choose system language.

- ☐ To configure system language:
 1. Press **Settings** from home screen of the i80 diagnostic application and select **Language**. Then all available language options display.
 2. Select your preferred language and click **Yes** to confirm.



Figure 10-1 Sample Language Setting Screen

10.3 Push Message

This option allows you to enable/disable **Push Message** function. Software updates and technical information will be delivered to you automatically. It is highly recommended to enable it all the time, so you won't miss out any new updates from Foxwell.

- ☐ To enable/disable Push Message:
 1. Press **Settings** from home screen of the i80 diagnostic application.
 2. Click the button on the right side. If turned to green, the Push Message function is enabled. If turned to grey, the function is disabled.



Figure 10-2 Sample Push Message Setting Screen

10.4 Automatic Update

This option allows you to enable/disable automatic update notice. If it is enabled, an orange update mark will show on the upper right of the diagnostic software icon whenever there is a new version available.



Figure 10-3 Sample Update Remark Screen

10.5 System Settings

This option provides you a direct access to the Android system settings, like sound, display, system security and etc. Refer to Android documentation for more information.

10.6 General

This option lets you to turn on/off the prompt when saving a file or login & registration when started the scanner.

10.7 Uninstall Vehicle Software

This option allows you to uninstall the vehicle software installed in the scanner.

 To uninstall a vehicle software:

1. Tap **Settings** application on home screen of i80.
2. Tap the **Uninstall Vehicle Software** option on the option list.
3. Choose the vehicle software you want to delete or choose **Select All**.



Figure 10-6 Sample Print Settings Screen

3. Tap **Print Plugin Manager** and turn on the Mopria Print Service, then i80 will search for available printers automatically.



Figure 10-7 Sample Print Service Manager Screen

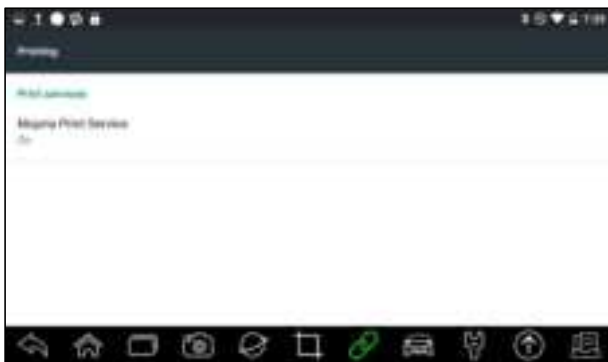

Figure 10-8 Sample Setting of Print Service Manager Screen

4. Choose the right printer.



Figure 10-9 Sample of Printer Screen

5. Choose the file or report you want to print and press the print icon .



Figure 10-10 Sample of File Printing Screen

NOTE

1. Please make sure the printer and the i80 in the same Wi-Fi or Network when printing.
 2. If Mopria Print Service driver can't workable for your printer, please download the driver to work for your printer on Print Service Manager.
-

10.9 About

Selecting **About** option opens a screen that shows information about the i80, such as serial number, hardware and software version and etc.

 To view information of your scan tool:

1. Press **About** from home screen of the i80 diagnostic application.
2. A screen with detailed information of the scanner displays.



Figure 10-11 Sample Tool Information Screen

11 Shop Manager

This section illustrates how to manage the workshop information, vehicle test records and customer information.

When Shop Manager application is selected, a menu with available service options displays. Menu options typically include:

- Vehicle History
- Workshop Information



Figure 11-1 Sample Shop Manager Screen

11.1 Vehicle History

This function keeps records of tested vehicles, including vehicle information and the fault codes from previous diagnostic sessions etc. Besides, **Vehicle History** also allows you to start a new test of tested vehicle without the need to do vehicle identification again by pressing the **Diagnostic** in the record.



Figure 11-2 Sample Vehicle History Screen

11.2 Workshop Information

The **Workshop Information** allows you to edit, input and save the detailed workshop information, such as shop name, slogan, address, phone number and more. It will show as the header of the printed documents when printing vehicle diagnostic reports and other test files.



Figure 11-3 Sample Workshop Information Screen

12 My Account

This section displays the information related to your account and product. When **My Account** application is selected, a menu with available options displays. Menu options typically include:

- My Account
- My Products
- Push Message
- Complaints

- Feedback and suggestions



Figure 12-1 Sample My Account Screen

12.1 My Account

My Account option allows you to check and modify your account information including user name, e-mail, telephone, address and so on.



Figure 12-2 Sample My Account Screen

12.2 My Products

This option let you activate a new product and manage activated products including serial number and expiration date.



Figure 12-3 Sample My Products Screen

12.3 Push Message

It will display all messages you got from Foxwell including software update notice and product news.

12.4 Feedback and suggestions

This option allows you to log on your e-mail and send feedback and suggestions about Foxwell products.

NOTE

Please download e-mail client on the i80 before using this function.



Figure 12-4 Sample Feedback & Suggestions Screen

13 Remote Support

Remote Control enables you to get remote support from Foxwell with TeamViewer when you have issues with Foxwell products.

- If you need our team to remote control your i80,
 1. Click the **Remote Control** icon on the main menu of the i80 to start TeamViewer.

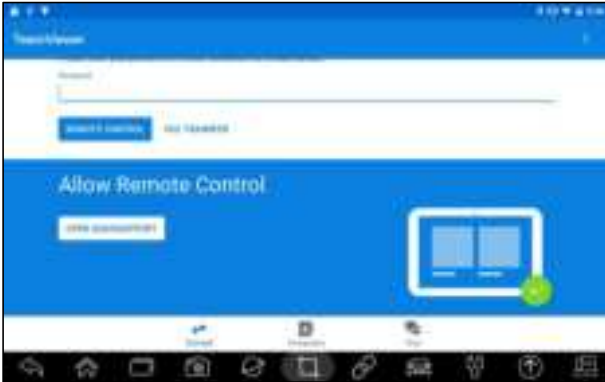

Figure 13-1 Sample Remote Control Screen

2. Press **QuickSupport** icon and the TeamViewer ID will show.



Figure 13-2 Sample QuickSupport Screen

3. Send your ID to us to let our team to take control your tablet.

14 Technical Data

This option provides you with the quick access to technical data like wiring diagram and repair tips provided by HaynesPro, AutoData or others.



Figure 14-1 Sample Technical Data Screen