

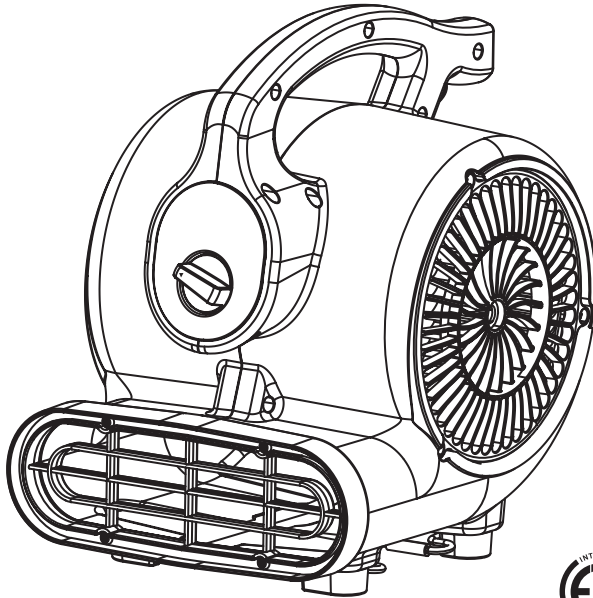

GF600A AIR MOVER

Owner's Manual



READ AND SAVE THESE INSTRUCTIONS

AlorAir Solutions INC.
Add: 14752 Yorba Ct, Chino, CA 91710 US
Tel: +1-888-990-7469
Email: sales@alorair.com

TABLE OF CONTENTS

SAFETY INSTRUCTIONS	1
ITEMS INCLUDED	2
DESCRIPTION OF PARTS	2
INTRODUCTION TO THE AIR MOVER	3
OPERATION GUIDE	3
USER MAINTENANCE GUIDELINES	5
TROUBLESHOOTING TIPS	6
TECHNICAL SPECIFICATIONS.....	7
ALORAIR LIMITED WARRANTY	8

SAFETY INSTRUCTIONS

WARNING - READ AND SAVE THIS INSTRUCTIONS BEFORE USING THIS PRODUCT.

****An electronic copy of this manual can be obtained through www.alorair.com****

The use of electrical products may pose various hazards, including but not limited to injuries, fires, and electrical shocks. Failure to adhere to these instructions can lead to damage, impaired operation, and voided warranties. Please take note of the following precautions:

- 1. Unpacking and Inspection:** Before operating this product, remove all packaging materials and carefully inspect it for any damage that may have occurred during shipping. Ensure that all components are included, and no items are missing.
- 2. Power Supply Check:** Verify that the household power supply matches the appliance's specifications before plugging it in.
- 3. Cord Safety:** NEVER operate the product if it has a damaged cord or plug. In such cases, either discard the product or return it to an authorized service facility for examination and repair.
- 4. GFCI Protection:** Use this appliance only on Ground Fault Circuit Interrupter (GFCI) protected receptacles. If needed, consult a qualified electrician for verification or installation of a GFCI receptacle.
- 5. Cord Placement:** Avoid running the cord under carpeting, covering it with throw rugs, runners, or similar coverings, or routing it under furniture or appliances. Position the cord away from high-traffic areas.
- 6. Speed Control:** To prevent the risk of fire or electric shock, DO NOT use this fan with any solid-state speed control device.
- 7. Wet Conditions:** NEVER touch this appliance or its plug with wet hands or while standing in water. Do not operate the unit in any pooled water.
- 8. Flammable Materials:** DO NOT use this product in areas where gasoline, paint, or other flammable substances are used or stored.
- 9. Ventilation and Exhaust:** DO NOT insert or allow objects to enter any ventilation or exhaust openings, as this may damage the appliance and void the warranty.
- 10. Air Inlet and Outlet:** Avoid covering the air inlet or outlet on the appliance.
- 11. Air Flow:** DO NOT direct the air flow at human faces or bodies.
- 12. Children:** Keep this appliance out of reach of children and do not allow them to play around or with it.
- 13. Servicing:** If the appliance requires servicing, ALWAYS disconnect it from the power supply to reduce the risk of injury.
- 14. Unplugging:** To unplug the product, grasp and pull on the power cord plug-end only, NEVER pull the cord directly.
- 15. Repairs and Adjustments:** NEVER attempt to repair or adjust any electrical or mechanical functions of this appliance, as it may pose danger and void the warranty.
- 16. Damaged or Malfunctioning Appliance:** If the appliance is damaged or malfunctions, immediately stop using it. Unplug it from the electrical outlet and refer to the troubleshooting guide or contact AlorAir for assistance.
- 17. Storage:** When not in use, store the appliance in a dry area, away from direct sunlight, extreme temperature and humidity, or other extreme environments.
- 18. Stacking:** DO NOT stack more than four units of this appliance.

ITEMS INCLUDED

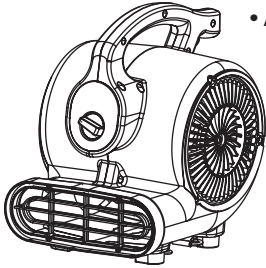

• Air Mover × 1

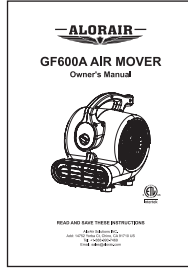

• Owner's Manual × 1

DESCRIPTION OF PARTS

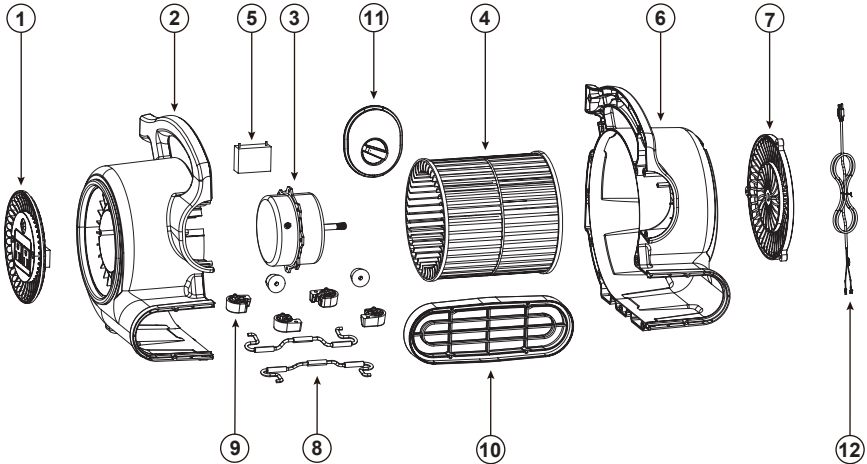

- 1. Inlet Grille Cover (Motor Side)
- 2. Left Housing
- 3. Motor
- 4. Fan

- 5. Capacitance
- 6. Right Housing
- 7. Inlet Grille Cover (Fan Side)
- 8. Kick Stand

- 9. Rubber Feet
- 10. Outlet Grille Cover
- 11. Switch Plate
- 12. Power Cord

INTRODUCTION TO THE AIR MOVER

The GF600A Air Mover is a high-capacity airflow device suitable for various applications and location sizes.

Key Features and Applications:

- 1. Versatile Airflow:** The GF600A Air Mover offers a robust airflow capacity, making it perfect for a wide array of tasks, regardless of the location's size.
- 2. Suitable for Tight Spaces:** This versatile unit is particularly well-suited for drying tight and hard-to-reach spaces, such as crawl spaces, under counters, inside cabinets, bathrooms, and even auto interiors. Its compact design allows the unit to efficiently circulate air in confined areas.
- 3. Professional Carpet Cleaning:** The GF600A is specifically designed for professional carpet cleaning. It aids in drying carpets efficiently after cleaning procedures, ensuring quick results and customer satisfaction.
- 4. Water Damage Restoration:** In cases of water damage, this air mover becomes an invaluable tool. It aids in the drying process, preventing mold growth and further damage.
- 5. Home Use:** The GF600A Air Mover is not limited to professional use. It is also suitable for home applications, providing homeowners with the means to address various drying and ventilation needs effectively.

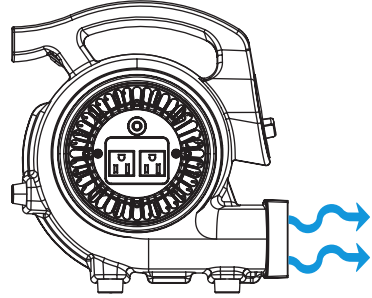

OPERATION GUIDE

Drying the Floor

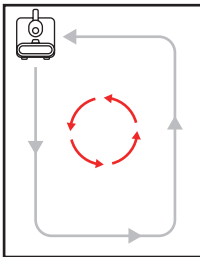

Single Unit:

Place the air mover at one corner of the area you intend to dry, to circulate airflow.

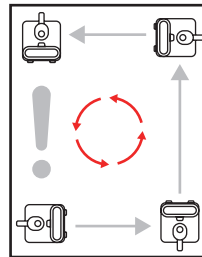

Multiple Units:

Place four air movers, one for each corner of the room, to circulate airflow.

Drying the wall or Ceiling

Selecting the Right Outlet Position:

The GF600A Air Mover offers five air outlet positions, each designed for unique usage scenarios. To meet the specific requirements of your drying task, choose the appropriate air outlet position (see different outlet positions below).

Understanding Usage Scenarios:

The unique functions of each outlet position help achieve effective drying. Adjust the angle of the air mover according to the usage scenario for optimal results.

Multiple Operating Positions:

The GF600A allows for flexible operation at different positions. You can direct the airflow precisely where needed, making it a versatile tool for various drying needs.

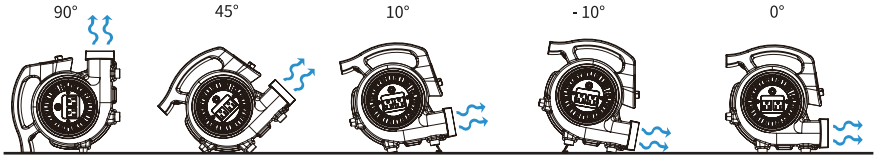

Using the Speed Switch

The GF600A Air Mover is equipped with a Speed Switch that allows you to control the fan's speed and operation. Here's how to effectively use this feature:

Turning the Air Mover ON and OFF:

- To switch the air mover OFF, simply turn the Speed Switch to the "OFF" position.
- To turn the air mover ON, select any of the speed positions by turning the switch to the desired setting.

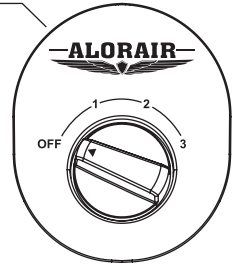

Adjusting Fan Speed:

To set your preferred fan speed, turn the Speed Switch clockwise. The GF600A offers three fan speed settings:

- "1" represents the lowest speed, suitable for gentle and quiet operation.
- "2" is a moderate speed, providing a balanced airflow for various tasks.
- "3" is the highest speed, delivering maximum airflow for rapid drying or ventilation.



Electrical Receptacles and Reset

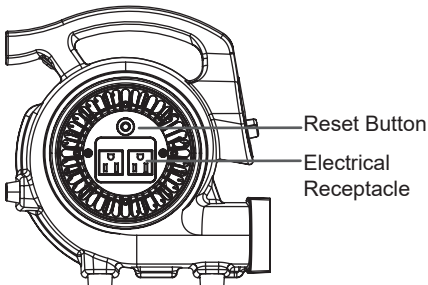

- Other appliances can be plugged into the additional electrical receptacles and function independently of the air mover. Ensure the total amperage remains below the instructed limit, which may vary between different models.
- If the air mover or any plugged-in appliance stops working, press the RESET BUTTON to reset the circuit.

OPERATION GUIDE (CONTINUED)

Storage

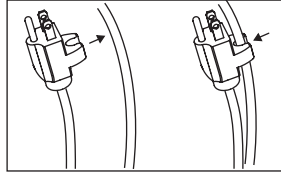
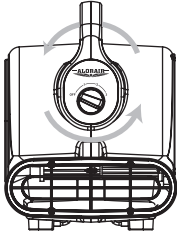

Cord Organization

- After use, wrap the power cord around the switch plate for storage.
- Secure the cord in place using the convenient clip at the end.

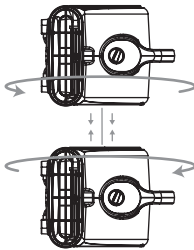

Stacking Multiple Units

- Stack the air movers on their sides with the air inlets aligned.
- Rotate the second air mover by 30°.

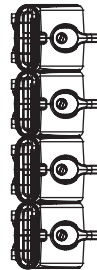

WARNING

- Do not stack more than four units of this appliance.
- Stacking function is not secure during transportation.

USER MAINTENANCE GUIDELINES

Frequent maintenance is recommended. Failure to follow these guidelines may void the warranty and lead to appliance failure.

- When not in use, unplug and store the appliance indoors, in a dry, cool place, out of children's reach.
- Always disconnect the air mover from its power source before performing maintenance or cleaning.
- Wipe the housing's surface with a damp cloth; avoid direct exposure to water.
- Ensure the grille covers are clean, removing any dirt or obstructions from the air inlet and outlet.
- Do not stack more than four units of this appliance.

TROUBLESHOOTING TIPS

PROBLEM	POSSIBLE CAUSE	SOLUTION
Air mover does not start	No electricity.	Check the power.
	The power cord is not properly plugged in.	Reconnect the power cord.
	Working under extreme temperatures.	Turn off, unplug, and allow cooling.
	Circuit breaker on additional electrical receptacle trips.	Remove appliances, press "Reset."
	Tachometer switch set to "0".	Set switch to "ON."
Unit runs but the speed is abnormal	Air inlet or air outlet is blocked.	Remove blockage.

* If troubleshooting does not resolve your problem, please contact AlorAir or other parties authorized by AlorAir for further instructions.

TECHNICAL SPECIFICATIONS

MODEL NUMBER	GF600A
Voltage / Frequency	115 V ~ 60 Hz
Amperage	1.0 A
Motor Power	1/8 HP
Rated Airflow	600 CFM
Speed Control	3 Speeds
Timer	N / A
Cord Length	10 ft / 3 m
Unit Dimension (L) × (W) × (H)	11.81 × 9.41 × 12.52 in / 30.0 × 23.9 × 31.8 cm
Unit Weight	7.9 lbs / 3.6 kg
Safety Certification	ETL / C-ETL

LIMITED WARRANTY

This limited warranty starts from the date of purchase. AlorAir Solutions INC. warrants to the original purchaser that this AlorAir product is free from manufacturing defects in material or workmanship for the limited warranty period of:

Six (6) Month parts and labor. This includes the shipments charges for replacement parts or units.

One (1) year parts and labor. The shipment fee to send the unit back to the manufacturer is not covered.

Three (3) years. Polyethylene body ONLY.

This limited warranty is valid only on products purchased from the manufacturer or AlorAir authorized dealer and operated, installed, and maintained according to the instructions included in this user guide or furnished with the product. AlorAir Solutions Inc will not provide in-home service during or after the warranty period. You may be responsible for the shipping charge to bring the product to the manufacturer for service.

To receive warranty service, the purchaser must contact AlorAir at 888-990-7469 or sales@alorair.com. Proof of purchase or order number is required to receive warranty service. During the applicable warranty period, a product will be repaired or replaced at the sole option of ALORAIR .

IMPORTANT NOTICE: Keep the item's packaging in case warranty service is required. In the event that the product is sent for repair without explicit guidance from our customer service team, AlorAir shall not assume responsibility for any associated repair costs.

LIMITED WARRANTY EXCLUSIONS

This limited warranty covers manufacturing defects in materials or workmanship encountered in a normal household, commercial or noncommercial use of this product and shall not cover the following:

- Damage occurs in users for which this product was not intended for.
- Damage caused by unauthorized modification or alteration of the product.
- Cosmetic damage including scratches, dents, chips, and other damage to the product's finishes.
- Damage caused by abuse, misuse, pest infestation, accident, fire, floods, or other acts of nature.
- Damage caused by incorrect electrical line current, voltage, fluctuations, and surges.
- Damage caused by failure to perform proper maintenance of the product.
- Damaged caused by using in a high humidity environment (75% or higher).
- Damaged caused by using next to combustible materials/equipment that may or may not produce carbon monoxide.



WARRANTY REGISTRATION CARD

Return To:
AlorAir Solutions

ORDER NUMBER: _____

MODEL: _____ **SERIAL #:** _____

INSTALLER: _____ **INSTALLATION DATE:** _____

NAME: _____

ADDRESS: _____

CITY: _____ **STATE:** _____ **ZIP:** _____

PHONE #: _____ **EMAIL:** _____



- ▶ If you have any questions, please feel free to contact us at [888-990-7469](tel:888-990-7469) or visit www.alorair.com
- ▶ Register your unit for warranty using this link: www.alorair.com/page/Warranty---Warranty-registration
- ▶ Warranty Registration <https://www.alorair.com> or scan this barcode to direct you to the warranty registration website.



AlorAir Solutions INC.
Add: 14752 Yorba Ct, Chino, CA 91710 US
Tel: +1 888-990-7469
Email: sales@AlorAir.com