



**Probing Solutions.
Made in Germany.**

EN



FireFly[®] Series

High Voltage Optically-Isolated Probes with Universal BNC Interface

>1.5 GHz, >180dB CMRR

Instruction Manual



Copyright © 2025 PMK - All rights reserved.

Manufacturer

PMK Mess- und Kommunikationstechnik GmbH
Königsteiner Str. 98
65812 Bad Soden, Germany

Tel: +49 (0) 6196 999 5000

Internet: www.pmk.de
E-Mail: sales@pmk.de

Warranty

PMK warrants this product for normal use and operation within specifications for a period of one year from date of shipment and will repair or replace any defective product, which was not damaged by negligence, misuse, improper installation, accident or unauthorized repair or modification by the buyer. This warranty is applicable only to defects due to material or workmanship. PMK disclaims any other implied warranties of merchantability or fitness for a particular purpose. PMK will not be liable for any indirect, special, incidental, or consequential damages (including damages for loss of profits, loss of business, loss of use or data, interruption of business and the like), even if PMK has been advised of the possibility of such damages arising from any defect or error in this manual or product.

Table of Contents

Warranty	2
Compliance Information	4
IEC Safety Information	5
Safety and Handling Information	6
Safety and Handling Information (Continued).....	7
Magnet Safety Information (for positioning accessories only)	7
Lithium-Ion 18650 Battery Charging and Storage Information	7
Clearance Requirements	8
About FireFly®.....	9
Factory Calibration.....	9
Specifications	10
Electrical Specifications ¹	10
Electrical Specifications (Continued)	11
Environmental Specifications	12
Physical Specifications.....	12
Dimensions.....	12
Typical Common Mode Rejection Ratio (CMRR).....	13
Typical Maximum Differential Input Voltage (CW)	13
Typical Frequency Response.....	14
Typical Pulse Response.....	14
Typical Differential Input Impedance	15
Remote Interface	15
User Interface	16
Interface Box Controls & Indicators	16
Probe Status Indicator.....	16
Probe Head Battery Level Indicators.....	16
Probe Head Power ON/OFF Button	17
Auto-Zero Button.....	17
Getting Started.....	17
Cable Selection.....	17
Probe Setup.....	17
Connection to the Test Points (Circuit-Under-Test)	19
Tips for Making Measurements with highest Signal Fidelity.....	19
CMRR Noise Suppression Kit	19
Scope of Delivery.....	20
Ordering Information	20

Compliance Information

The FireFly® probing system complies with the following relevant union harmonization legislation, safety and environmental standards. Only professionals and qualified personnel should use this product. Serious injury or death may occur as result of incorrect usage of this product.

Probe

- IEC/EN 61010-1:2010 - Safety Requirements for Electrical Equipment for Measurement, Control and Laboratory Use, Part 1: General Requirements
- IEC/EN 60825-1 - Safety of Laser Products Part 1: Equipment Classification and Requirements -Edition 3 (2014)
- US 21CFR Part 1010 - Performance Standards for Electronic Products: General
- US 21CFR Part 1040 - Performance Standards for Light- Emitting Products
- Laser Certification: Class 1 Laser Product

This product complies with 21 CFR 1040.10 and 1040.11 except for deviations pursuant to Laser Notice No. 50, dated June 24, 2007.

CAUTION. Use of controls or adjustments for performance of procedures other than those specified herein may result in hazardous exposure.

Battery



Do not use any other batteries than recommended by PMK.
Only use chargers that are suitable for Li-Ion batteries.

- EU model

Manufacturer: Ansmann AG, Industriestr. 10, 97959 Assamstadt, Germany
Model: 18650 protected Lithium-Ion rechargeable battery, 3.6V, typ. 3400mAh, safety board inside, inclusive micro-USB charging input connector, CE and UKCA conform.

The battery switches off at approx. 2.5V to protect the battery against deep discharge.



For optimum battery performance, fully charge the battery before first use.
Charge the battery via the USB socket or with an 1850 charger.
Leave the charger connected until the charge indicator reaches 100%.

- US model

Manufacturer: Tenergy, 436 Kato Terrace, Fremont, CA 94539 U.S.A.
Model: 30016-04, 18650 protected Lithium-Ion rechargeable battery, 3.7V, 2600mAh, UL1642 certified.

The battery switches off at approx. 2.75V to protect the battery against deep discharge.

- Asian model

Manufacturer: Quantum Lighting Products Limited, Flat A, 13/F, Efficiency House, 35 Tai Yau Street, San Po Kong, Kowloon, Hong Kong
Model: LG 18650 protected Lithium-Ion rechargeable battery, 3.6V, 3400mAh, TYPE C charging input connector, IEC62133, PSE conform.

The battery switches off at approx. 2.5V to protect the battery against deep discharge.

IEC Safety Information

IEC Measurement Categories

This probe series is not rated for CAT II, III or IV.

Definitions and Examples:

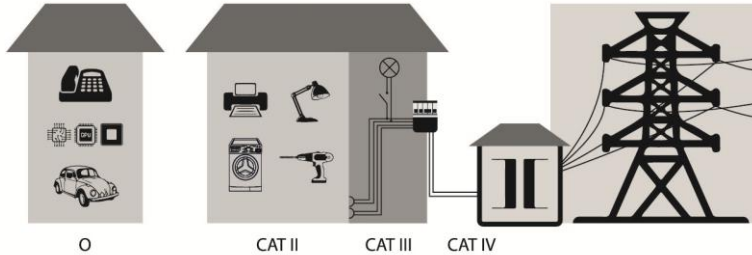

Overview of measurement categories according to IEC 61010-01

O = No Measurement Category (Other circuits that are not directly connected to mains)

IEC Pollution Degree

- Pollution Degree 1** No POLLUTION or only dry, nonconductive POLLUTION. NOTE: The POLLUTION has no influence.
- Pollution Degree 2** Only- nonconductive POLLUTION. Occasionally, however, a temporary conductivity caused by condensation must be accepted.
- Pollution Degree 3** Conductive POLLUTION occurs or dry, non-conductive POLLUTION occurs which becomes conductive due to condensation which is to be expected.

IEC Safety Symbols

The following symbols may appear on the product or in this instruction manual:



Caution, risk of danger. Refer to manual.



Caution, risk of electric shock.



Earth (ground GND) TERMINAL.



Caution with cardiac pacemaker; implantable cardioverter defibrillator



Caution, static magnetic field hazard.

Safety and Handling Information

The probe head, tip cables and accessories are NOT for hand-held use. The overall safety of any measurement setup incorporating this probe is the responsibility of the user.



The probe head is optically isolated and galvanically isolated from the measuring system and earth ground.



To avoid personal injury and to prevent fire or damage to this product or products connected to it, review and comply with the following safety precautions. Be aware that if you use this probe assembly in a manner not specified, the protection this product provides may be impaired. Only qualified personnel should use this probe assembly.



Beware of High Voltages.

Observe probe and probe accessory ratings. Do not apply any electrical potential to the probe input, which exceeds the maximum ratings of the probe head, tip cables or the accessories connected to it. In a combination, the lower rating / measurement category applies to both the probe and accessories connected to it. Make sure to comply with the voltage versus frequency derating curve.

Do not connect the probe head/tip cable to an energized circuit to avoid the risk of shock. Always de-energize the circuit-under-test before installing or removing the probe head or tip cable from the circuit-under-test. The plastic case of the probe head and insulating sleeve on the tip cable do not supply adequate isolation.



Keep away from hazardous live circuits.

Avoid open circuitry. Do not touch connections or components when power is present. Maintain safe clearance from the Probe Head and Tip Cable while connected to the energized circuit

Avoid unnecessary stress. Do not overbend the fiber cable or probe tip cable.

The small electrical components of the probe are sensitive to shock and impact. Avoid any unnecessary stress to the probe like throwing, falling and strong vibrations.

The FireFly® fiber cable between the probe head and the interface box contains multiple optical fibers. Avoid tight radius bends, crushing, crimping, twisting, or otherwise stressing of the fiber cable. Do not crush, crimp, twist, pull, jerk or sharply bend the fiber-optic cable. Avoid making loops in the fiber-optic cable smaller than 12.7cm (5in).

Avoid over-bending the Probe Head's Tip Cables; do not exceed the minimum bend radius of 5cm (2in).

Keep products clean and dry.

Remove all connections of the probe before cleaning. Keep the fiber cable clean and free from contaminants in order to maintain the 60kV common mode voltage rating.

Inspect the fiber cable for dirt, contaminants or damage before each use and clean using a dry, lint-free cloth. If dirt remains, use a soft cloth or swab dampened with a 75% isopropyl alcohol solution and rinse with deionized water. A swab is useful for cleaning narrow spaces, use only enough solution to dampen the swab or cloth. Do not use abrasive compounds on any part of the probe.

Do not use chemical cleaning agents; they may damage the probe. Avoid using chemicals that contain benzene, benzene, toluene, xylene, acetone, or similar solvents.

Continues on next page.

Safety and Handling Information (Continued)

Do not operate with suspected failures.

Refer to qualified service personnel.

Do not operate in wet or damp conditions.

Condensation may occur if a unit is moved from a cold to a warm environment.

Do not operate the product in an explosive atmosphere.



Connect and disconnect properly.

The circuit-under-test **MUST BE DE-ENERGIZED (TURNED OFF)** when handling, connecting & disconnecting the probe head, tip cables or accessories to the circuit.

Use ONLY non-conductive probe head & tip holders.

Use only PMK recommended 18650 batteries in the probe head.

Avoid applying an input signal without batteries in the probe head.

Use only the originally provided carry case to store or transport the probe not in use.

If the probe is no longer being used, and before the probe is placed back into the probe case, remove the battery from the probe head for storage.

Magnet Safety Information (for positioning accessories only)



A neodymium magnet has been installed in FireFly® positioning accessories FF-HAL10kV-A3, FF-2FOOTERA, FF-3DPOS200A. Read the referring FireFly series positioner manual before first use.



A digital copy of the revision can be downloaded at www.pmk.de

Various objects react sensitively to the static magnetic fields of permanent magnets. Magnets generate a far-reaching, strong magnetic field. They can damage credit cards, EC cards, storage media, mechanical watches, pacemakers, hearing aids and loudspeakers, among other things. Keep magnets away from all devices and objects that can be damaged by strong magnetic fields.

Recommended safety distances:

High-quality magnetic card (credit card, EC card, bank card)	15mm
Cheap magnetic card (parking garage, trade fair entrance)	42mm
Pacemaker (new)	62mm
Pacemaker (old)	80mm
Mechanical watch (anti-magnetic)	32mm
Mechanical watch (not anti-magnetic)	176mm
Hearing aid	20mm

Lithium-Ion 18650 Battery Charging and Storage Information

For optimal charging, the ambient temperature during charging should be 24±2.5°C. Batteries should be stored in a dry, room temperature space. Avoid any situations that might subject the batteries to either extreme cold or heat. Between the range of -20°C to +50°C (-4°F to +122°F) is sufficient but the most optimal storage temperature is somewhere around 77°F or 25°C.



Before handling the probe head to change the battery, make sure the circuit under test has been de-energized or has been disconnected from the circuit-under-test.

Use ONLY the PMK recommended 18650 batteries, in the probe head. If using a battery with a built in USB charge port, connect the appropriate USB cable and connect to a USB port on the oscilloscope, AC power adaptor or PC.

Charging times will vary based on the battery and the charger used.



For optimum battery performance, fully charge the 18650 battery before first use. Charge the battery via the USB socket or with an 1850 charger. Leave the charger connected until the charge indicator reaches 100%.



Observe battery safety: The FireFly® probe head is powered by a user-replaceable 18650 rechargeable Lithium-Ion battery.

To avoid personal injury or property damage due to electrical burst, smoke, fire or explosions, please operate the probe within the specified operating conditions.

Do not drop the probe or subject it to strong impacts.

Do not use the probe if it has been damaged in any way.

Clearance Requirements

The probing system can be used for very high common mode voltages. Observe all pre-cautions and information from the manual when using this product. See also the specifications and referring derating curves in this manual.



Maintain at least 1m (40in) safe clearance of the probe head, tip cable and tip cable accessories in all directions when connected to an energized

circuit.

RF burn hazard zone around the probe head and tip cable:



Maximum Safe Handling Limits:

Common Mode Voltage (Probe Head to Earth Ground)

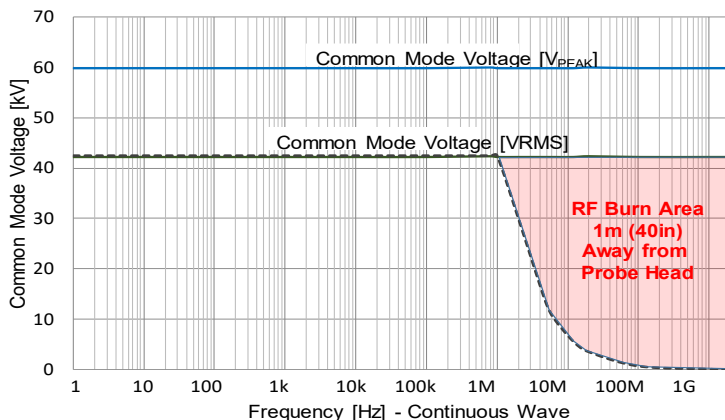

About FireFly® Series

The FireFly® high voltage optically isolated probes offer industry leading performance that combines the ability to accurately resolve high bandwidth, small differential signals in the presence of large common mode voltages with its ultra-high common mode rejection performance across its entire bandwidth. With >1.5GHz bandwidth, wide differential input range, unmatched common mode rejection ratio CMRR up to >180dB (1 billion to 1 rejection), and a 60kV common mode, FireFly® is the ideal measurement solution for both GaN and SiC device characterization and system level design development.

PMK's optically isolated interface and unique compact angled probe head design are the key attributes that set FireFly® apart from the other solutions in the market, providing very stable and accurate measurements over a wide temperature range and easy access to the measurement points in tight spaces.

The compact angled probe head design allows for shorter tip cables to be used, resulting in higher signal fidelity measurements and reduced stresses placed on the measurement test point. FireFly®'s wide selection of probe tip connections and accessories offer reliable, hands-free, high-fidelity connectivity to the measurement points. Using industry standard MMCX and square pins connections allow FireFly® to easily interface to test boards that have already been designed with these test points.

FireFly® has a universal BNC output connector and is compatible with any oscilloscope with a 50Ω input impedance or 1MΩ input impedance and a 50Ω feed-through termination, allowing FireFly® to be used on any oscilloscope in the lab.

For accurate deskew, each probe's unique propagation delay is measured and added to each probe label.

The FireFly® probe head can be powered either with a power-over-fiber adapter for 24/7 continuous operation (FF-1500A-10m is not compatible with FF-POF-A01) or by an easy to change, rechargeable, industry standard 18650 battery that provides continuous operation for up to 30h at room temperature. The interface box is powered in both cases by the required PMK power supply. The multichannel power supplies all have remote control capabilities and therefore a USB interface and optional additional LAN interface. As an alternative for most flexible use, the 1 channel battery pack power supply AP-01 provides >8h of portable and isolated operation but has no software remote control.

FireFly® series has the capability to be controlled from either remote control or the controls located on the interface box.

For remote control PMK offers the software "PMK Probe Control" with graphical user interface, which is shipped with any multichannel power supply, and is available for download at:

<http://www.pmk.de/en/products/probecontrol>

In addition, the Python package "PMK-probes" is available as a programming interface for controlling PMK's active probes. Installation instructions, examples and documentation can be found here:

<https://pmk-probes.readthedocs.io/en/latest/>

Factory Calibration

Annual re-calibration is recommended. ISO17025 calibration upon delivery or as re-calibration is possible on request.

Specifications

Read the Instruction Manual before first use and keep it for future reference. A digital copy of the latest Instruction Manual revision can be downloaded at www.pmk.de

Specifications that are marked with * are guaranteed, others are typical. Do not exceed specifications. Allow the probe to warm up for 20 minutes. The probe head and tip cables are not for handheld use. The probe can be used without the probe tip. To achieve the most accurate measurement results, review the "Getting Started" section in the Instruction Manual. This probe comes with 1 year warranty.

Electrical Specifications¹

Observe adequate spacing between probe head components and earth ground. This product is not rated for CAT II, III or IV. Do not exceed the specifications. Use original PMK power supplies only.

FireFly®	Bandwidth * (-3dB)	Rise time * (10% - 90%)	Input Attenuation	Input Impedance ²
SMA Input	> 1.5 GHz	<250 ps	1X	200 kΩ 5.1 pF
FF-MMCX-1V	> 1.5 GHz	<250 ps	1X	50 Ω ³
FF-MMCX-10V	> 1.3 GHz	<280 ps	10X	2 MΩ 3.4 pF
FF-MMCX-25V	> 1.3 GHz	<280 ps	25X	4.9 MΩ 2.1 pF
FF-MMCX-50V	> 1.3 GHz	<280 ps	50X	10 MΩ 2 pF
FF-MMCX-250V	> 1.3 GHz	<280 ps	250X	20 MΩ 2.1 pF
FF-WSQ-500V	> 1.0 GHz	<300 ps	500X	40 MΩ 2.8 pF
FF-WSQ-1000V	> 1.0 GHz	<300 ps	1000X	40 MΩ 2.9 pF
FF-WSQ-1500V	> 1.0 GHz	<300 ps	1500X	40 MΩ 2.7 pF
FF-WSQ-2500V	> 1.0 GHz	<300 ps	2500X	40 MΩ 2.5 pF

Maximum Rated Input Voltages ⁴

Common Mode Voltage ⁵ (Maximum Voltage to Earth)	± 60 kV (DC + Peak AC)	
No Measurement Category	Linear Input Voltage Range (DC + Peak AC) ²	Maximum Non-Destruct Differential Input Voltage (DC + Peak AC) ²
SMA Input	± 1 V	5 V
FF-MMCX-1V	± 1 V	5 V
FF-MMCX-10V	±10 V	50 V
FF-MMCX-25V	± 25 V	100 V
FF-MMCX-50V	± 50 V	100 V
FF-MMCX-250V	± 250 V	300 V
FF-WSQ-500V	± 500 V	3000 V **
FF-WSQ-1000V	± 1000 V	3000 V **
FF-WSQ-1500V	± 1500 V	3000 V **
FF-WSQ-2500V	± 2500 V	3000 V **
Pollution Degree	2	

See next page for more Electrical Specifications and footnotes.

Electrical Specifications (Continued)

Common Mode Rejection Ratio	DC	1 MHz	100 MHz	200 MHz	500 MHz	1 GHz
SMA Input	> 180 dB	165 dB	124 dB	122 dB	121 dB	118 dB
FF-MMCX-1V	> 180 dB	153 dB	113 dB	110 dB	109 dB	107 dB
FF-MMCX-10V	> 180 dB	144 dB	105 dB	100 dB	97 dB	95 dB
FF-MMCX-25V	> 180 dB	137 dB	91 dB	87 dB	86 dB	86 dB
FF-MMCX-50V	> 180 dB	132 dB	86 dB	83 dB	80 dB	81 dB
FF-MMCX-250V	> 180 dB	122 dB	75 dB	71 dB	69 dB	68 dB
FF-WSQ-500V	> 180 dB	101 dB	63 dB	60 dB	51 dB	49 dB
FF-WSQ-1000V	> 180 dB	94 dB	59 dB	56 dB	46 dB	42 dB
FF-WSQ-1500V	> 180 dB	91 dB	55 dB	51 dB	43 dB	35 dB
FF-WSQ-2500V	> 180 dB	89 dB	52 dB	45 dB	41 dB	32 dB
DC Gain Accuracy	< 2 % ± DC Offset voltage					
Noise (input referred)	FF-1500A (2 m fiber cable): SMA Input (1X): < 2 mV rms		FF-1500A-10m (10 m fiber cable): SMA Input (1X): < 3 mV rms			
	<i>With tip cable: (SMA Input noise) · (Tip cable input attenuation)⁷ scales proportionally to tip attenuation</i>					
DC Offset Voltage (input referred)	SMA Input (1X): < 1.5 mV (After Auto-Zero) ⁸					
	<i>With tip cable: (SMA Input offset voltage) · (Tip cable input attenuation)⁹ scales proportionally to tip attenuation</i>					
Temperature Drift	< 0.05%/°C					
Propagation Delay	2 m fiber cable: 15 ns		10 m fiber cable: 55 ns			
	<i>The probe specific value is measured and printed on interface box label, tip cable approx. 500 ps</i>					
Battery Life	> 30 h @ 22 °C – 25 °C, > 20 h @ 0 °C, >4 h @ 50 °C <i>Dependent on probe head operating temperature (Continuous Operation)</i>					
Output Termination & Coupling	50 Ω DC					
Battery Type	Protected 18650 Li-Ion, Rechargeable, 3.7V Certified					
Laser Certification	Laser Class 1 IEC/EN 60825-1:2014, US 21CFR Part 1010, US 21CFR Part 1040					

Notes:

* Guaranteed specification

** Preliminary specification

¹ Determined when using a PS-02 power supply at +23°C ambient temperature.² For input voltage and input impedance derating graphs review the FireFly® instruction manual.³ Terminated, 50 Ω transmission line.⁴ As defined in IEC 61010-1. Rated for indoor, dry location use only.⁵ Galvanically isolated FireFly® probe head through fiber optic connection.⁶ CMRR performance is >180dB below 100kHz. See CMRR graph.⁷ Example: 10x tip FF-MMCX-10V noise = 10x SMA input noise.⁸ For long cable versions, the DC offset is more sensitive, so do not move the fiber cable during measurements.⁹ Example: 10x tip FF-MMCX-10V offset = 10x SMA input offset.

Environmental Specifications

Parameter	Specification		
Temperature Range	Operating	Probe Head	0 °C to +50 °C
		Interface Box	0 °C to +40 °C
		Tip Cables & Adapters	-40 °C to +85 °C
	Non-Operating	Probe Head & Interface Box	-20 °C to +71 °C
		Tip Cables & Adapters	-40 °C to +85 °C
Maximum Relative Humidity	Operating	Probe Head	5 % to 85 % RH (relative humidity) at up to +40 °C, 5 % to 45 % RH above +40 °C up to +50 °C, non-condensing
		Interface Box	5 % to 85 % RH (relative humidity) at up to +40 °C, non-condensing
	Non-Operating	Tip Cables & Adapters	5% to 85% RH (relative humidity) at up to +85 °C, non-condensing
		Probe Head & Interface Box	5 % to 85 % RH (relative humidity) at up to +40° C, 5 % to 45 % RH above +40° C up to +71° C, non-condensing
Maximum Altitude	Operating		3000 m (9843 ft)
	Non-Operating		15000 m (49213 ft)

Physical Specifications

Parameter	Specification	
Weight	Probe	2 m: 325 g / 10 m: 625 g
	Tip Cable	11 g
Length	Tip Cable	9.5 cm (3.74")
	Fiber Cable	2 m (6.56 ft) / 10 m (32.81 ft)
Connectors	Probe	Input: SMA (Female) – Probe Head Output: BNC (Male) - Interface Box

Dimensions

The dimensions shown are in mm. Drawings from the probe tips are coming soon. If the needed drawing is missing, please contact us via sales@pmk.de

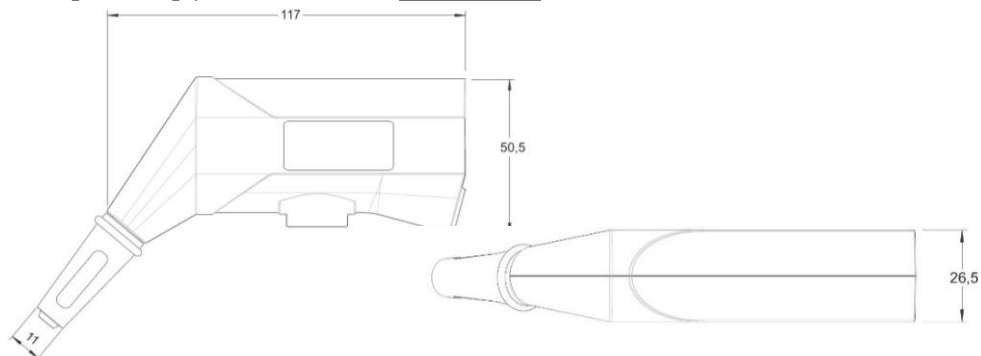

Typical Common Mode Rejection Ratio (CMRR)

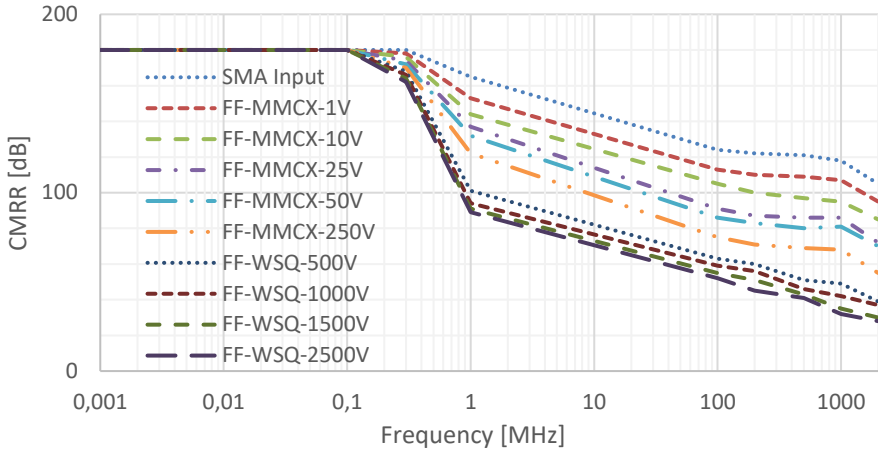

Typical Maximum Differential Input Voltage (CW)



Note that the maximum input voltage rating of the probe decreases as the frequency of the applied signal increases.

The maximum input voltage derating is coming soon.

Typical Frequency Response

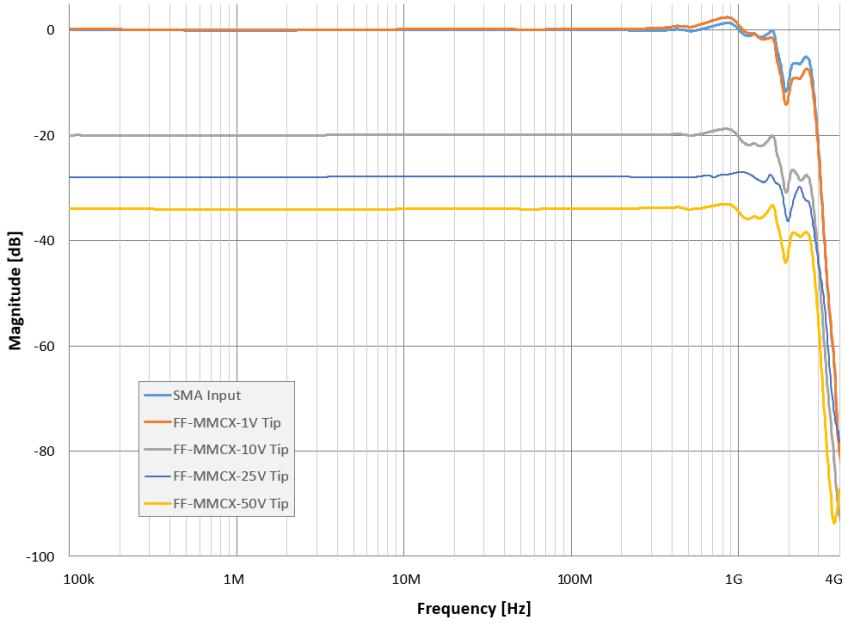

Typical Pulse Response

The graphs are normalized to 1 for better comparison.

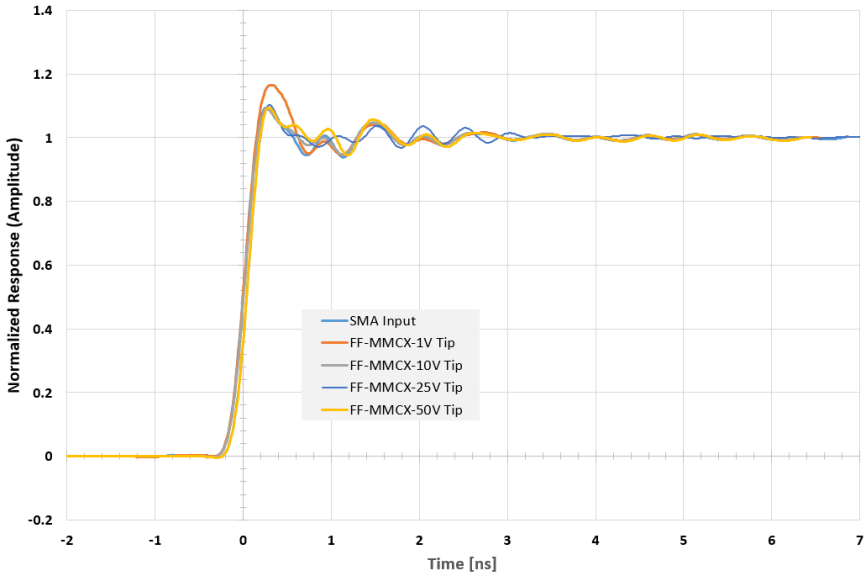

Typical Differential Input Impedance



Note that the maximum input voltage rating of the probe decreases as the frequency of the applied signal increases.

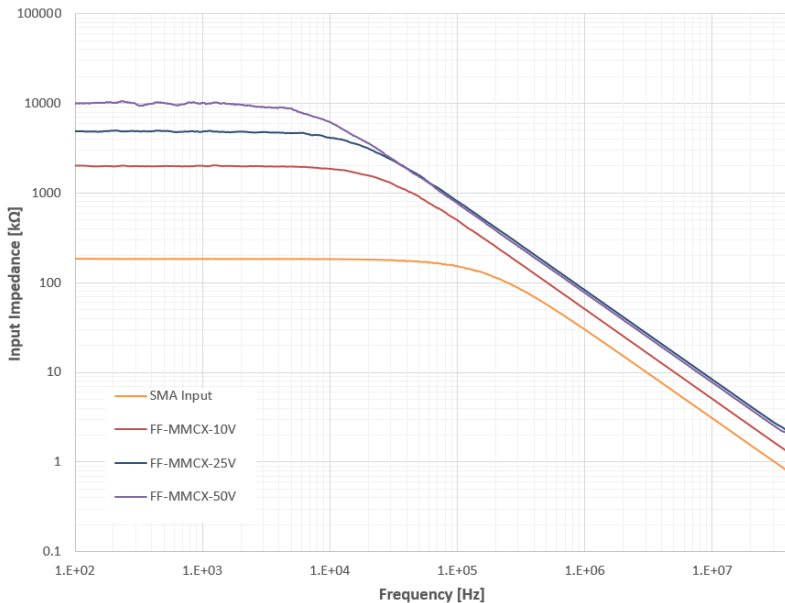

Remote Interface

FireFly® series has the capability to be controlled from either remote control or the controls located on the interface box.

For remote control PMK offers the software “PMK Probe Control” with graphical user interface, which is shipped with any PS2 and PS3 power supply, and is available for download at:

<http://www.pmk.de/en/products/probecontrol>

In addition, the Python package "PMK-probes" is available as a programming interface for controlling PMK's active probes. Installation instructions, examples and documentation can be found here:

<https://pmk-probes.readthedocs.io/en/latest/>

In order to achieve the highest CMRR and minimum CM loading, keep the probe head away from surrounding metal or earth ground.

User Interface

Interface Box Controls & Indicators

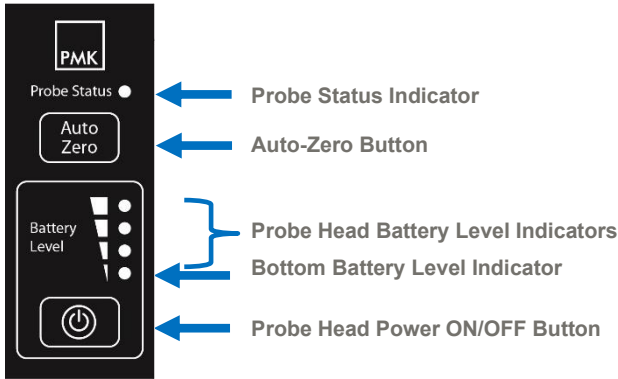

Probe Status Indicator

Indicator	Status	Action/Information
	Green (Blinking) Wait: Probe Head Warm Up	Initializing after power-up: Probe head has successfully powered up and is still warming up. Probe head not ready. Do not energize your circuit under test.
	Green (Solid) READY: Probe Head Power ON	Successfully powered up and probe head is on and warmed up. Ready for measurements.
	Red (Blinking) Probe Head OFF – Empty Battery	Caution – Empty or missing battery. Probe Head is powered OFF and not able to pass a signal. Probe head not ready.
	Yellow (Solid) Probe Head Power OFF	Caution - Probe Head is powered OFF and not able to pass a signal. Probe head not ready.
	Blue (Solid) Auto-Zero In Process	Auto-Zero is in process - Very fast. Probe head not ready. De-energized circuit under test before performing an Auto-Zero required.
	Red Blue (Blinking) Error Condition	An error condition has occurred - Power cycle the probe & check probe head battery. Probe head not ready. Do not energize your circuit under test. If power cycling not successful, please contact us via service@pmk.de .

Probe Head Battery Level Indicators

The Battery Level Indicators will illuminate after the Probe Head is turned on.

Indicator	Status	Action / Information
	Normal Operation 1 - 4 Green LEDs	Ready for measurements. Four (4) Solid Green LEDs indicates the battery is full and One (1) Solid Green LED indicates the battery will soon need to be replaced.
	Low Battery (Warning)	Battery replacement recommended.
	Low Battery (Critical)	Warning - Battery needs to be changed.
	Empty or NO Battery installed	Action required: Probe Head is NO longer in operation and passing a signal - De-energize your circuit - Check and replace battery

Probe Head Power ON/OFF Button

Turn the probe head ON before use and power OFF after use to conserve the battery. The Interface Box will power up even if the probe head is in the Probe Head OFF mode. See Probe Status Indicator Information.



When the Probe Head is in the OFF mode, the probe will not pass a signal.

Auto-Zero Button

Press the Auto-Zero Button on the probe interface box to remove any DC offset errors (drift) in the probe's output. See Probe Status Indicator overview for more information.



Make sure the circuit-under-test is de-energized. No signal must be applied to probe tip.

Getting Started

Read the Safety and Handling Information, the Specifications and the entire Instruction Manual before first use, and keep them for future reference. A digital copy of the latest revision can be downloaded at www.pmk.de

Cable Selection

Each tip cable has a set of labels on them that specify the linear input voltage range as well as the attenuation factor to correctly setup the scale factor on the oscilloscope to display the correct signal amplitudes. When selecting a tip cable for the measurement being made, consider the following criteria:

- 1) Maximum DC + AC peak voltage at the test point to be measured
- 2) Minimum differential loading (input resistance and capacitance) that test circuit can tolerate
- 3) Minimum needed sensitivity for the measurement (minimum V/div setting)

Probe Setup

- 1) **Connect the FireFly® Interface Box** to the BNC input of the oscilloscope or other measurement system with either an internal or external 50Ω input termination. If using a tip cable, attach the tip cable to the probe head SMA connector by turning it clockwise until fully tightened, so the tip cable is secure and not loosen up when in use. Set the propagation delay on the oscilloscope to the measured propagation value printed on the FireFly® Interface Box's label and add the tip cable/accessory delay if one is used. Set the oscilloscope's attenuation scale factor to the tip cable's attenuation.
- 2) **Connect the referring PMK Power Supply**, e.g. model 2ch PS2, 4ch PS3 or battery pack AP-01, to the power connector on the FireFly® Interface Box using a PMK Probe Connection Cable. Turn on the Power Supply. The Interface Box Probe Status Indicator turns red and the Probe Head Battery Level Indicators will light to indicate the probe head's battery level.



The power supply pin assignment is different from other power supplies. Use only original PMK power supplies with PMK probes.



Before handling the probe head, tip cable or tip cable accessories, make sure the circuit-under-test is either de-energized or not connected to the probe.

Probe's power supply pin assignment "cable view"

3) Insert or Replace the Battery

Open the probe head's battery compartment by unscrewing the battery cap counter-clockwise. *Insert* or replace the existing battery with a fully charged 18650 rechargeable battery or with the Power-over-Fiber adapter, in order to achieve the longest probe head operating time. Follow the polarity markings on the compartment. Make sure that the positive end of the battery goes in first and the negative end of the battery is facing out, towards the battery cap. Close the probe head's battery compartment by screwing the battery cap back onto the probe head in the clockwise direction and tighten.



4) Power ON/OFF the Probe Head

Press the Probe Head Power ON/OFF Button to turn on the probe head. Battery indicators will only illuminate when the Probe Head Power is turned ON and will turn off when Probe Head Power is turned OFF. Wait for the Probe Status Indicator on the interface box stops blinking quickly and turn greens, which means the probe is now ready to make a measurement.

5) Connect an insulating Probe Holder

Insert the probe with its holder straight from the top into the probe holder. A stable connection was made. To remove the holder, unplug the magnetic holder from the probe head. Insert the magnetic holder into the FireFly's probe head body. A stable connection was made. To remove the holder, unplug the magnetic holder from the probe head.

If another probe holder is being used, use non-conducting probe holders only.

6) Attach the Probe Tip Cable or accessory input connector to the circuit-under-test. When using an MMCX connector, insert the tip cable's MMCX plug straight into the mating socket until a "click" sound occurs to indicate a proper connection between the plug and socket.



Do not overbend the tip cable.

Observe a disengagement force of <8N for longest MMCX connector lifetime.

When removing the tip cable from the MMCX socket, grasp the tip cable's MMCX connector and pull straight out, taking care not to wiggle the connector side-to-side to prevent excessive stresses on the socket and its connection to the DUT.

7) Auto-Zero Button

The probe is warmed-up after 20minutes. Press the Auto-Zero button on the interface box to remove any DC offset errors (drift) in the probe's output.



Perform Auto-Zero after each tip cable change and after each fiber-cable movement.

8) Ready for making the measurements: Apply power to the circuit-under-test to begin making the measurements. To achieve the most stable measurements, allow the probe to warm up 20 minutes.

Connection to the Test Points (Circuit-Under-Test)

To achieve the best performance from the FireFly® probe, use an MMCX connector as close to the test point as possible. The MMCX connectors provide a compact footprint and solid metal body that provide the best signal fidelity of the signal being measured as well as shielding down as close as possible to the test point. This connection also provides a stable and repeatable measurement.

To achieve the best electrical performance, especially the CMRR performance and EMI susceptibility, place the probe tip adapter/accessories as close as possible to the circuit board.

To minimize the effects of common mode capacitive loading of the probe head/tip cable and maximum CMR, consider the following items.

- Whenever possible, connect the coaxial (common) shield of the tip cable to the test point that has the least dynamic signal, with respect to earth ground, relative to the tip cable signal (center) test point in the circuit-under-test.
- The coaxial (common) shield of the tip cable and tip cable adapters should always be connected to the lowest impedance point (usually a circuit common or power supply rail) in the circuit-under-test (relative to the tip cable/center conductor) to obtain the most accurate waveform.
- Increasing the physical distance between the probe head/tip cable and any conductive surface will reduce the parasitic capacitance.

Tips for Making Measurements with highest Signal Fidelity

- To achieve the best CMRR performance, make sure to tighten the tip cable to probe SMA connection.
- Measure as close as possible to the desired measurement point.
- Avoid fiber movement when making a precise measurement.
- If use a tip cable adapter/accessory with input leads, twist the input leads together to reduce the input inductance and improve the CMRR of the test setup.
- Add external ferrite beads over the tip cable or adapter/accessory as close as possible to the test points will improve the CMRR and common mode loading on the circuit-under-test.

CMRR Noise Suppression Kit

For use with probe tip cables to improve the overall common mode rejection ratio. Installing these ferrites onto FireFly® probe tip cable in use to improve the Common Mode Rejection Ratio (CMRR) and increase the Common Mode Impedance above 100MHz, typically. Up to a 20dB improvement to the Common Mode Rejection Ratio (CMRR) can be realized above 100MHz by installing these ferrites. For the best results, place the ferrites as close to the tip/measurement point as possible.

Scope of Delivery

Not all required items are included in the scope of delivery of the base probe FireFly® FF-1500A/FF-1500A-10m. See Ordering Information to configure your individual probing solution and select a required PMK power supply. The following is included in the scope of delivery.

- **FF-1500A / FF-1500A-10m** FireFly® base probe, $\pm 1V$ input range
- **890-520-900** Interface box probe connection cable (0.6m)
- **FF-2FOOTER**A Probe head holder 2-Footer (Bi-Pod), strong magnetic holding force
- **891-102-CMRR** CMRR Noise Suppression Kit for Firefly®
- 2x 18650 rechargeable Lithium-Ion batteries
- USB Wall charger + USB cable (for battery charging) *Charger type may vary by region*
- Set cable coding rings (3x4 colors)
- Carrying case (black, plastic)
- Instruction Manual
- Safety Information



The accessories for this probe series have been safety tested.
Do not use any other accessories, batteries or power supplies than what is recommended.

Ordering Information

Step 1: Select Probe Head

FF-1500A	FireFly® optical isolated probe, 1.5GHz, >180dB, 2m fiber cable (2 batteries and 2footer included, required power supply to be ordered separately)
FF-1500A-10m	FF-1500A with 10m fiber cable
FF-POF-A01	Power-Over-Fiber adapter for 24/7 continuous operation of the FireFly® probe head without using the 18650 battery at room temperature. One additional power supply channel is required. FF-1500A required.



The POF adapter is not compatible with the 10m FF-1500A-10m.

Step 2: Select Probe Tip Cables

The probe tip cables are interchangeable without requiring any tools. The probe head SMA input range is $\pm 1V$ with no attenuation. Also review our new ultra-fast current shunt series UFCS on www.pmk.de.

FF-MMCX-1V	FireFly® probe tip cable, MMCX, $\pm 1V$, >1.5GHz, 1x attenuation, 50 Ω terminated for shunt measurements
FF-MMCX-10V	FireFly® probe tip cable, MMCX, $\pm 10V$, >1.3GHz, 10x attenuation
FF-MMCX-25V	FireFly® probe tip cable, MMCX, $\pm 25V$, >1.3GHz, 25x attenuation
FF-MMCX-50V	FireFly® probe tip cable, MMCX, $\pm 50V$, >1.3GHz, 50x attenuation
FF-MMCX-250V	FireFly® probe tip cable, MMCX, $\pm 250V$, >1.3GHz, 250x attenuation
FF-WSQ-500V	FireFly® probe tip cable for 5.08mm square pins, $\pm 500V$, >1.0GHz, 500x attenuation
FF-WSQ-1000V	FireFly® probe tip cable for 5.08mm square pins, $\pm 1kV$, >1.0GHz, 1000x attenuation
FF-WSQ-1500V	FireFly® probe tip cable for 5.08mm square pins, $\pm 1.5kV$, >1.0GHz, 1500x attenuation
FF-WSQ-2500V	FireFly® probe tip cable for 5.08mm square pins, $\pm 2.5kV$, >1.0GHz, 2500x attenuation

Step 3: Select Connectivity Accessories

Observe the frequency derating of each accessory. Observe maximum input voltage of the probe's input. Do not use any other accessories.

FF-SQ-MMCX5

5x MMCX to 2x 0.025" (0.635mm) socket, -40°C to +125°C



FF-HTSPAD-MMCX3

3x MMCX solder-in cable adapter HT, 50Ω RF micro coax to flex solder-in pad, -40°C to +155°C (green = 0Ω, yellow = 36Ω, red = 75Ω)
 Probe tip solder-in adapters have different damping resistor values to reduce eventually occurring ringing/oscillations:

0 Ohm = no damping

36 Ohm = light to medium damping

75 Ohm = heavy damping



FF-HTS-MMCX2

2x MMCX solder-in cable adapter HT, MMCX socket with 50Ω RF micro coax cable and open end, -40°C to +155°C



FF-UFL-MMCX2

2x MMCX cable adapter, MMCX socket with 50Ω RF micro coax cable to U.F.L socket, -40°C to +125°C



FF-2XR-MMCX

MMCX to 2x XR Mini-Hook



FF-WSQ-4mm-2

2x extension lead for FireFly® HV tips (5.08mm pitch) to 2x 4mm safety banana plugs (male), e.g. to use BumbleBee® series accessories



FF-WSQ-SPADE-2

2x extension lead for FireFly® HV tips (5.08mm pitch) to spades (Ø4mm opening)



FF-MMCX-SPADE-3

3x extension lead for FireFly® MMCX tips to spades (Ø4mm opening)



972416100 2-pole test clip SMD for use with FF-SQ-MMCX5



P25-2 Pico Hook™ red for use with FF-SQ-MMCX5



P25-0 Pico Hook™ black for use with FF-SQ-MMCX5









D010031 50Ω BNC feed-through for 1MΩ input oscilloscopes





Step 4: Select Shunt for Current Measurements

Each resistance model is available as single pack or as more cost-effective packs of 10 or 25 pieces. An input tip cable with 50Ω termination, e.g. FF-MMCX-1V, is required for use with these shunts. The Shunts have a 50Ω female SMA output, so an SMA to MMCX adapter is needed as well.

UFCS-R001	1mΩ, bandwidth TBD, <200pH insertion inductance, TBD A maximum pulse current, SMA (F) output, 1pc. Also available as packs: 10pcs UFCS-R001x10 , 25pcs UFCS-R001x25	
UFCS-R005	5mΩ, >800MHz bandwidth, <200pH insertion inductance, TBD A maximum pulse current, SMA (F) output, 1pc. Also available as packs: 10pcs UFCS-R005x10 , 25pcs UFCS-R005x25	
UFCS-R011	11mΩ, >1GHz bandwidth, <200pH insertion inductance, 104A maximum pulse current @ 100μs, SMA (F) output, 1pc Also available as packs: 10pcs UFCS-R011x10 , 25pcs UFCS-R011x25	
UFCS-R024	24mΩ, >1GHz bandwidth, <200pH insertion inductance, 70A maximum pulse current @ 100μs, SMA (F) output, 1pc Also available as packs: 10pcs UFCS-R024x10 , 25pcs UFCS-R024x25	
UFCS-R052	52mΩ, >900MHz bandwidth, <200pH insertion inductance, 48A maximum pulse current @ 100μs, SMA (F) output, 1pc Also available as packs: 10pcs UFCS-R052x10 , 25pcs UFCS-R052x25	
018-291-970	Adapter for use of UFCS series shunts with FireFly® series. SMA plug to MMCX socket, 50Ω	

Step 5: Select Positioning System

FF-3DPOS200A	FireFly® 3D Probe Positioner for 10kV Insulation with steel base (893-100-001), arm with span width 200mm (893-200-200), FireFly® non-conducting probe holder (FF-HAL10kV-A), Wrench 7mm, strong magnetic holding force	
FF-HAL10kV-A3	FireFly® non-conducting probe holder, max 10kV for use with PMK's 3D Probe Positioning Systems and SKID Probes and PCB Board holder systems, strong magnetic holding force, pack of 3 – spare parts	
FF-2FOOTERA	FireFly® positioner 2-Footer (Bipod), non-conducting, strong magnetic holding force - included in probe's scope of delivery	

Step 6: Select Power Supply

A PMK power supply PS2 or PS3 is required for using the probe, also when powering the probe head with the optional Power-over-Fiber adapter FF-POF-A01 instead of an 18650 battery.



The power supply pin assignment is different from other power supplies. Use only original PMK power supplies with PMK probes.

889-09V-PS2	PS-02 (2 channels, with USB interface for remote control)
889-09V-PS2-L	PS-02-L (2 channels, with LAN and USB interface for remote control)
889-09V-PS3	PS-03 (4 channels, with USB interface for remote control)
889-09V-PS3-L	PS-03-L (4 channels, with LAN and USB interface for remote control)
889-09V-AP01	AP-01 (battery pack, 1 channel, no remote control)
890-520-900	Power supply cable (0.6 m), included in probe's scope of delivery
890-520-915	Power supply cable (1.5 m)

Observe Connector Pin-Out
for PMK power supply cables



Step 7: Select Accredited Calibration

KAL-DAKKS-FF	ISO 17025 (re-)calibration
---------------------	----------------------------

Step 8: Select Additional Accessories

D010031	50Ω BNC feedthrough for use with 1MΩ oscilloscope inputs, 0.5W
----------------	--

Coming Soon / In Development

New connectivity solutions

If you need any non-published accessory, please contact us via sales@pmk.de

Copyright © 2025 PMK - All rights reserved.

Information in this publication supersedes that in all previously published material.
Specifications are subject to change without notice.

Informationen in dieser Anleitung ersetzen die in allen bisher veröffentlichten Dokumenten.
Änderungen der Spezifikationen vorbehalten.