



# ELL6(K), ELL9(K), and ELL12(K)

## Optic Slider Kits

Operating Manual



Original Instructions

# Table of Contents

Chapter 1 Introduction .....	1
Chapter 2 Safety.....	2
2.1 General Warnings and Cautions .....	2
Chapter 3 Installation .....	3
3.1 Environmental Conditions.....	3
3.2 Mounting.....	4
Chapter 4 Operation .....	7
4.1 Getting Started.....	7
4.2 Controlling the Stage .....	7
4.2.1 Hand-held Controller .....	8
4.2.2 Software Control .....	9
4.2.3 Communications Protocol .....	10
4.2.4 Connecting Multiple Devices .....	10
4.2.5 Controlling the stage without the handset .....	10
4.3 Periodic Cycling of Devices Over Full Range of Travel .....	12
4.4 Frequency Search.....	12
4.5 Restoring Factory Settings .....	12
4.6 Simultaneous Movement of Devices.....	13
Chapter 5 Troubleshooting and FAQ .....	14
5.1 Frequently Asked Questions .....	14
5.2 Notes on Making a Picoflex Cable for Use when Daisy Chaining Devices.....	15
Chapter 6 Specifications .....	17
Chapter 7 Regulatory.....	18
7.1 Declarations of Conformity.....	18
7.1.1 For Customers in Europe .....	18
7.1.2 For Customers In The USA.....	19
Chapter 8 Thorlabs Worldwide Contacts.....	20

---

## Chapter 1 Introduction

The ELL6, ELL9, and ELL12 are multi-position optic sliders with millisecond switching times enabled by Thorlabs' Elliptec™ piezoelectric resonant motor technology. The ELL6 Dual-Position Slider and the ELL9 Four-Position Slider are both compatible with SM1 optics, while the ELL12 Six-Position Slider is used with SM05 optics.

The resonant piezo design of the motors offers fast response times and precise positioning, and are therefore particularly useful in scanning applications. These piezo motors also do not include magnets like traditional motors, making them ideal for applications that are sensitive to electromagnetic interference.

The high-speed digital signal processing (DSP) architecture supports a multi-drop serial communication protocol, and a set of digital IO lines allows the user to control the movement and state manually by switching the lines high (5V) or low (0V).

The sliders can be post-mounted using our ER series cage system rods and a CP33(/M) Cage Plate (see [Section 3.2](#)). They are also compatible with 30 mm cage systems. The ELL6, with its single motor, can be simultaneously controlled and powered via USB. The TPS101 5 V power supply is also compatible. As the two motors on the ELL9 and ELL12 require greater power, a 5 V power supply is included with the ELL9K and ELL12K bundles.

A hand-held controller is also supplied with the kits to allow manual switching between the optic positions. The units can also be driven remotely via PC-based software, downloaded from [www.thorlabs.com](http://www.thorlabs.com). A compatible USB driver is included in the software download package.

## Chapter 2 Safety

For the continuing safety of the operators of this equipment, and the protection of the equipment itself, the operator should take note of the Warnings, Cautions and Notes throughout this handbook and, where visible, on the product itself.

**Warning: Risk of Electrical Shock**

Given when there is a risk of electrical shock.

**Warning**

Given when there is a risk of injury to the user..

**Caution**

Given when there is a possibility of damage to the product.

**Note**

Clarification of an instruction or additional information.

### 2.1 General Warnings and Cautions

**Warning**

If this equipment is used in a manner not specified by the manufacturer, the protection provided by the equipment may be impaired. In particular, excessive moisture may impair operation.



The equipment is susceptible to damage from electrostatic discharge. When handling the device, anti-static precautions must be taken and suitable discharge appliances must be worn.

Spillage of fluid, such as sample solutions, should be avoided. If spillage does occur, clean up immediately using absorbent tissue. Do not allow spilled fluid to enter the internal mechanism.

If the device is operated over a prolonged time period, the motor housing may become hot. This does not affect motor operation but may cause discomfort if contacted by exposed skin.

Do not bend the PCB. A bending load in excess of 500 g applied to the board may cause the PCB to deform, which will degrade the performance of the controller.

Do not expose the stage to a strong infrared light (e.g. direct sunlight) as it could interfere with the operation of the position sensor.

During use do not place the PCB directly onto electro-conductive material e.g. an optical table top or breadboard.

**Caution**

The home sensor of the device relies on a 950nm led which can leak from the device. This should be taken into consideration for environments that are especially sensitive to foreign light sources.

## Chapter 3 Installation

### 3.1 Environmental Conditions

**Warning**

Operation outside the following environmental limits may adversely affect operator safety.

Location	Indoor use only
Maximum altitude	2000 m
Temperature range	15°C to 40°C
Maximum Humidity	Less than 80% RH (non-condensing) at 31°C

To ensure reliable operation the unit should not be exposed to corrosive agents or excessive moisture, heat or dust.

Do not expose the stage to magnetic fields as this could affect the positioning and homing sensor operation.

If the unit has been stored at a low temperature or in an environment of high humidity, it must be allowed to reach ambient conditions before being powered up.

The unit is not designed to be used in explosive environments.

The unit is not designed for continuous operation. Lifetime will depend on several factors, e.g. load, number of homing operations, number of frequency searches etc. The minimum lifetime is 100 km.

## 3.2 Mounting

**Warning**

The safety of any system incorporating this equipment is the responsibility of the person performing the installation.

**Cautions**

Although the module can tolerate up to 8kV of air discharge, it must be treated as an ESD sensitive device. When handling the device, anti-static precautions must be taken and suitable discharge appliances must be worn.



When handling the stage, take care not to touch the wires to the motors.

Do not bend the wires over the motor spring as this affects the performance of the unit.

Do not allow the wires to contact other moving parts.

The ribbon cable connector is made of plastic and is not particularly robust. Do not use force when making connections. Unnecessary or repeated plugging in and unplugging should be avoided or the connector may fail.

Do not move the stage by hand. Doing so will disorientate the motors and cause the unit to fail.

The recommended mounting orientation is vertically, with the motors at the bottom of the board as shown below. In this orientation, optic position 1 is on the right hand side.

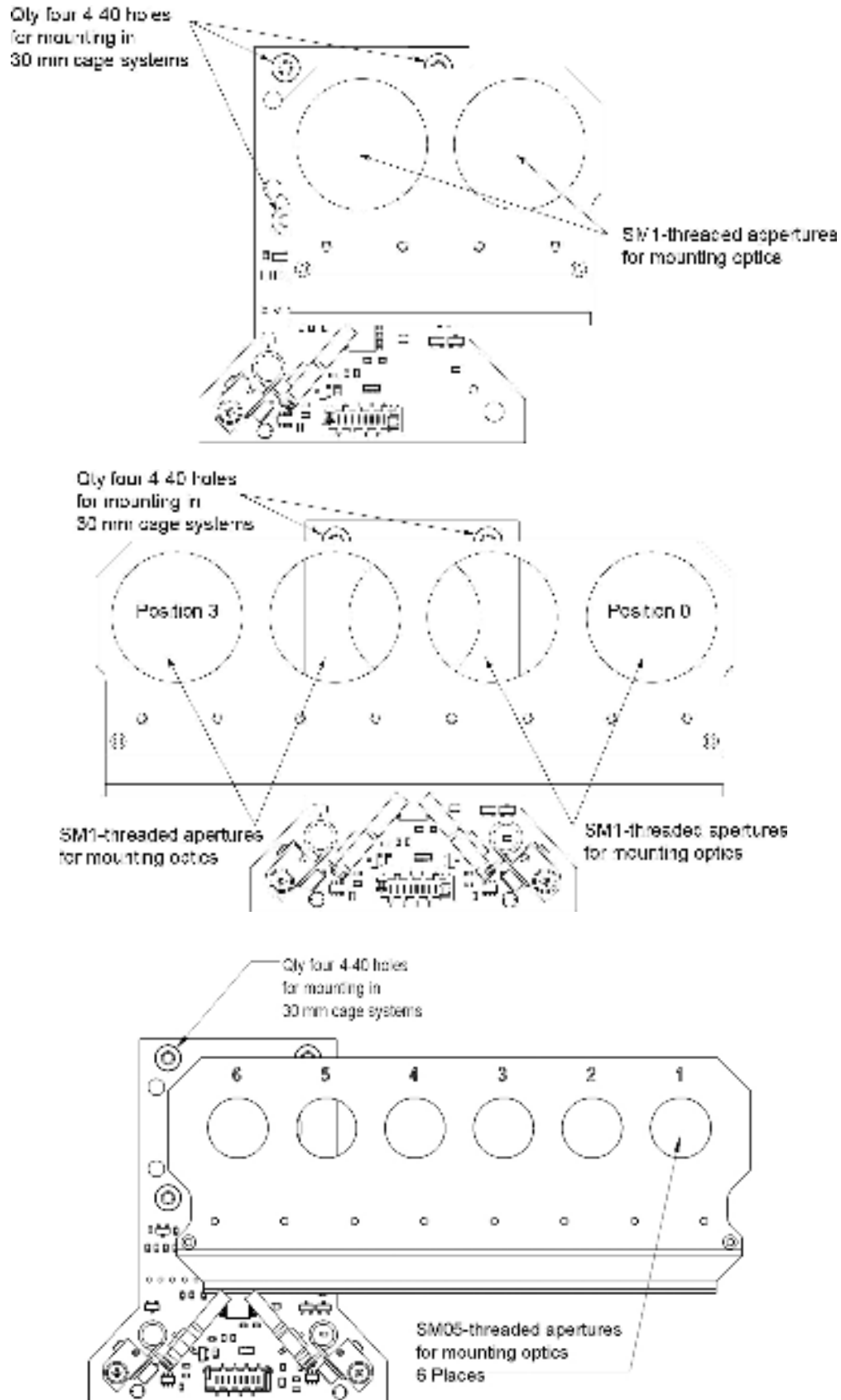

Figure 1 ELL6, ELL9, and ELL12 Optic Sliders

There are several options for mounting the sliders. The ELLA1 Post Mount Adapter has a 14.0 mm width and fastens directly to the back of the slider's PCB. As shown in Figure 2, the adapter can then be used to mount the slider to a Ø1/2" post. The compact dimensions of the ELLA1 allows sliders to be placed one behind the other while minimizing the space separating them, as shown below. The adapter can also be integrated with Thorlabs' 30 mm Cage System components and/or SM1-threaded components, such as lens tubes. Alternately, 30 mm cage system components alone can be used to mount the sliders. An example of this is shown in Figure 3, in which a CP33 Cage Plate, four ER1 rods, a Ø1/2" post, and a post holder mount and support the assembled sliders.



Figure 2 ELL9 mounted using ELLA1



Figure 3 ELL9 mounted using 30 mm cage rods



Figure 4 Close mounting of ELL6 and ELL9 using ELLA1



## Chapter 4 Operation

### 4.1 Getting Started

**Caution**

Although the module can tolerate up to 8kV of air discharge, it must be treated as an ESD sensitive device. When handling the device, anti-static precautions must be taken and suitable discharge appliances must be worn.



Do not expose the slider to a strong infrared light (e.g. direct sunlight) as it could interfere with the operation of the position sensor.

When power is applied, do not connect or disconnect the ribbon cable connecting the USB/PSU adapter to the Stage PCB. Always remove power before making connections.

Do not move the stage by hand. Doing so will disorientate the motors and cause the unit to fail.

The home sensor of the device relies on a 950nm led which can leak from the device. This should be taken into consideration for environments that are especially sensitive to foreign light sources.

**Warning**

If the device is operated over a prolonged time period, the motor housing may become hot. This does not affect motor operation but may cause discomfort if contacted by exposed skin.



1. Perform the mechanical installation as detailed in Section 3.2
2. Turn on and boot up the host PC.
3. Connect the handset to the stage if required.

**Caution**

The unit is easily damaged by connections with incorrect polarity. Pin 1 of the connector on the PCB is marked with an arrow (see Figure 8 and section 5.2) which should be adjacent to the red wire in the connecting cable.

4. Connect the stage to a 5V supply and switch 'ON'. (A 5 V PSU is supplied with the ELL6K, ELL9K, and ELL12K).

**Caution**

Boot up the PC BEFORE connecting the USB cable. DO NOT connect a powered ELL kit to a PC that is not powered up and running.

5. Using the USB cable supplied, connect the handset to the PC.
6. Wait for the drivers to be installed.
7. Home the stage. Homing is necessary to align the sensor and establish a datum from which all future moves are measured.

### 4.2 Controlling the Stage

The stage can be controlled in three ways; via the handset (section 4.2.1), by the Elliptec software running on a PC (section 4.2.2), or by writing a custom application using the messages described in the communications protocol document. Homing and position switching functionality can also be accessed by applying voltages to the digital lines on Connector J2. The modes of control are described in the following sections.

In all modes, when the unit is mounted in the recommended orientation as shown in Figure 1. Forward moves the stage to the right and backward moves to the left.

### 4.2.1 Hand-held Controller



#### Caution

On power up the stage will move while the unit checks the sensors and then searches for the home position.

The ELL6K, ELL9K, and ELL12K Evaluation Kits also contain a hand-held controller, which features two buttons (marked FW and BW) that allow switching of the optic position as explained below. The handset also provides for connection to the host PC and to the external 5V power supply. This allows the stage to be used in the absence of a PC, with control being achieved via the handset buttons.

The PWR LED (LED1) is lit green when power is applied to the unit. The INM LED (LED2) is lit red when the device being driven is in motion.

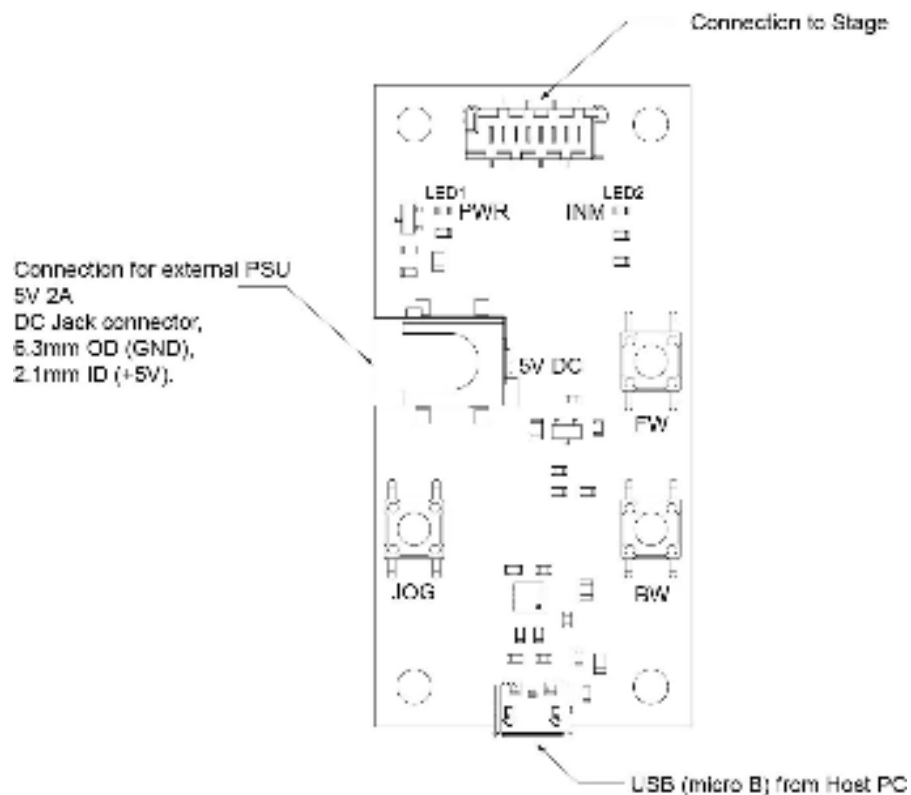

Figure 5 Handset details

Using the hand-held controller and referencing *Figure 1* and *Figure 5*:

1. Connect the Interface Board to the Slider unit.
2. Connect the Interface Board to the Power Supply.
  - a) ELL6: a micro-USB connection with 5V @ 500mA will suffice.
  - b) ELL9 & ELL12: a standalone 5V @  $\geq 1A$  supply must be connected prior to a USB connection.
3. Switch ON the supply and wait while the stage powers up and goes through its homing sequence.
4. To increment the slider position:
  - a) ELL6: press FW.
  - b) ELL9 & ELL12: press and hold JOG, then press FW.
5. To decrement the slider position:
  - a) ELL6: press BW
  - b) ELL9 and ELL12: press and hold JOG then press BW.

Note. For ELL6 the JOG button initiates a demo loop
6. To Home the stage (i.e. go to position 1) press the BW button.

### 4.2.2 Software Control

When connected to the host PC, the stage can be controlled remotely, via the Elliptec software.

1. Download the Elliptec software from the Downloads section at [www.thorlabs.com](http://www.thorlabs.com). Double click the saved .exe file and follow the on-screen instructions.
2. Connect the hand-held controller to the stage unit.
3. Connect the hand-held controller to the 5V Power Supply and switch on.
4. Connect the hand-held controller to the PC USB port and wait for the drivers to be installed.
5. Run the Elliptec software.
6. In the top left of the GUI panel displayed, select the COM port to which the device is connected (see Figure 6, and click 'Connect'. The software will search the comms bus and enumerate the device.

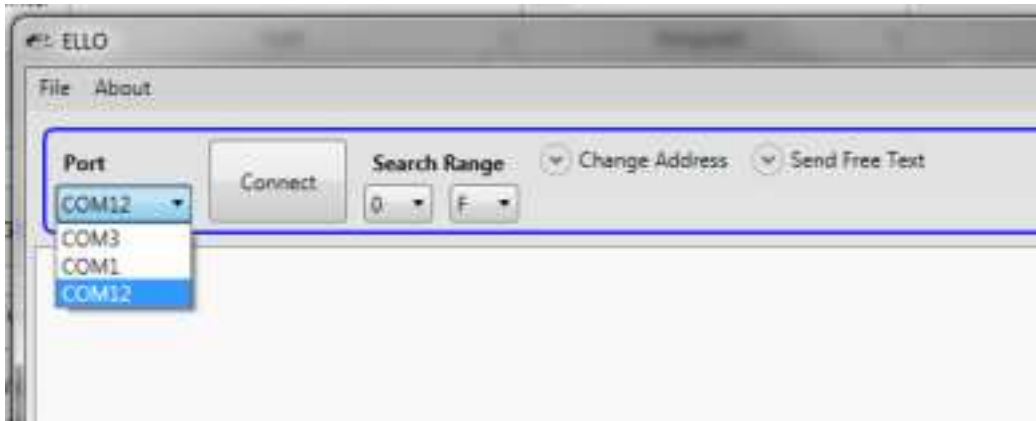

Figure 6 COM port drop down menu

7. Click the 'Home' button to home the stage.
8. The GUI and device are now ready for use. Click the position buttons to move to each position as shown in Figure 7 (0 on the right hand side of the slider through to 3 on the left hand side). See the helpfile supplied with the software for more information.

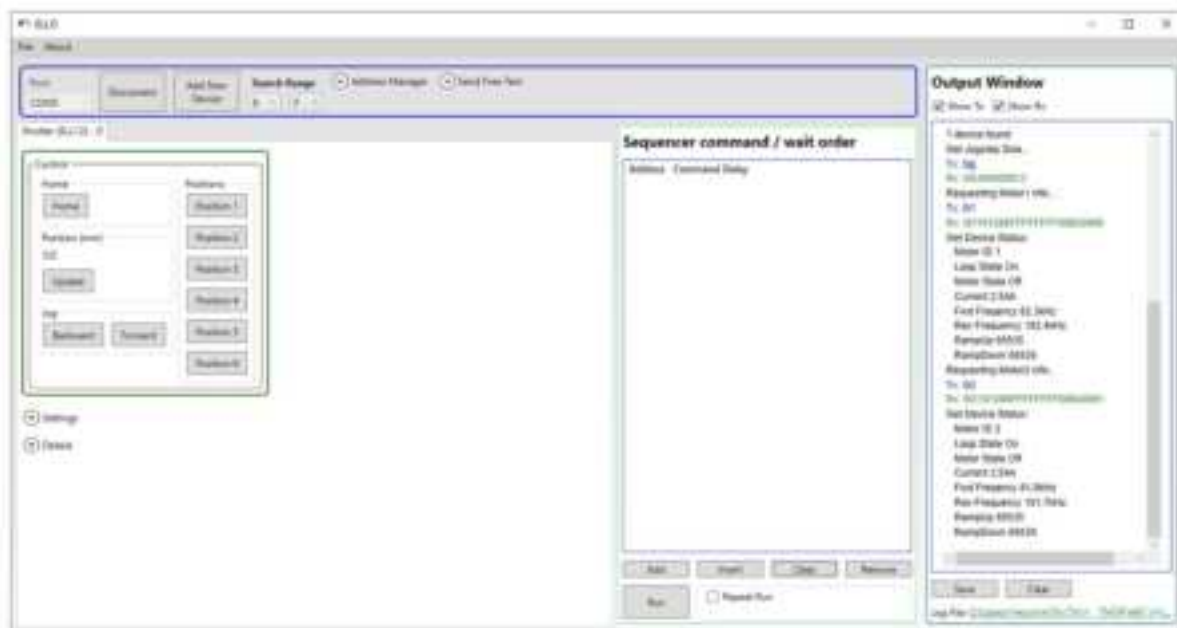

Figure 7 Main GUI panel

### 4.2.3 Communications Protocol

Custom move applications can be written in languages such as C# and C++.

The communication bus allows multi-drop communication with speeds at 9600 baud, 8 bit data length, 1 stop bit, no parity.

Protocol data is sent in ASCII HEX format, while module addresses and commands are mnemonic character (no package length is sent). Modules are addressable (default address is "0") and addresses can be changed and/or saved using a set of commands. Lower case commands are sent by user while upper case commands are replies by the module.

Please refer to the communications protocol manual for more detail about commands and data packet formats.

### 4.2.4 Connecting Multiple Devices

When a device is first connected to the PC, it is assigned the default address '0'. The software can run multiple devices, however before more than one device can be recognized, each device must be assigned a unique address. See below for a brief overview; detailed instructions are contained in the help file supplied with the software.

Connect the first device to the PC USB port, then run the Elliptec software and load the device.

Change the address of the first device.

Connect the next device to the first device.

Change the address of the second device.

Multiple devices can be controlled individually, either via a remote handset connected to each device, via the Elliptec software or by a third part application written using the messages detailed in the protocol document.

### 4.2.5 Controlling the stage without the handset

**Caution**

During normal operation each motor is protected by a 1 second pause to prevent overheating. Wait for 1 second between moves and do not try to drive the motors continuously.

In the absence of the handset, the stage is controlled via digital lines: forward, backward and mode (J2 pins 7, 6 and 5, see Figure 8) by shorting the corresponding line to ground (pin 1).

When the stage is moving, the open drain IN MOTION digital line (pin 4) is driven low (active low) to confirm movement. The IN MOTION line goes high (inactive) when the move is completed or the maximum time-out (2 seconds) is reached.

**Warning**

Do not exceed the voltage and current ratings stated in Figure 8.

Do not reverse polarity.

**Connector J2 Pin Out**

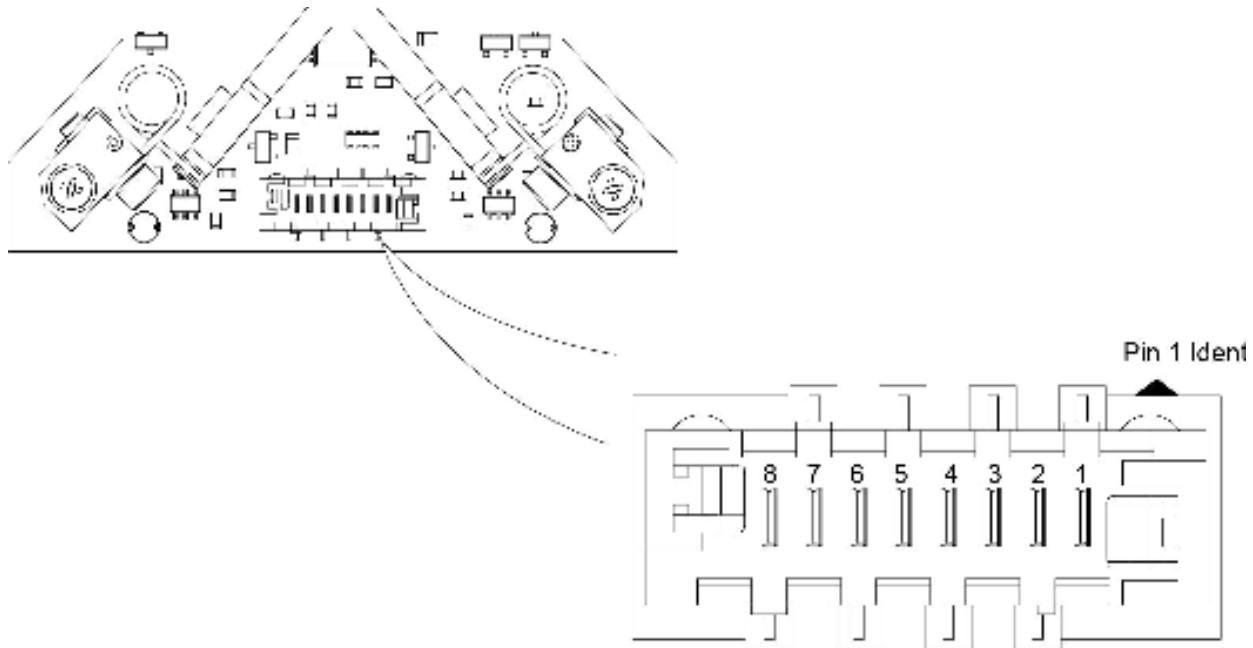

PIN	TYPE	FUNCTION
1	PWR	Ground
2	OUT	ODTX - open drain transmit 3.3 V TTL RS232
3	IN	RX receive - 3.3V TTL RS232
4	OUT	In Motion, open drain active low max 5 mA
5	IN	ELL6: JOG/Mode = Normal/Test Demo, active low max 5 V ELL9 and ELL12: JOG/Mode, active low max 5 V
6	IN	BW Backward , active low max 5 V
7	IN	FW Forward, active low max 5 V
8	PWR	ELL6: VCC +5V +/-10% 600 mA ELL9 and ELL12: VCC +5V +/-10% 1200 mA

**Connector model number MOLEX 90814-0808 Farnell order code 1518211**

**Mating connector model number MOLEX 90327-0308 Farnell order code 673160**

**Figure 8 Connector J2 pin out details**



**Caution**

The ribbon cable connector (J2) is made of plastic and is not particularly robust. Do not use force when making connections. Unnecessary or repeated plugging in and unplugging should be avoided or the connector may fail.

### 4.3 Periodic Cycling of Devices Over Full Range of Travel

**Caution**

Periodically, devices should be moved over the full range of travel, from one end to the other. This will help minimize the build up of debris on the track and will prevent the motors digging a groove over the most used area of contact. Typically, a travel cycle should be performed every 10K operations.

### 4.4 Frequency Search

Due to load, build tolerances and other mechanical variances, the default resonating frequency of a particular motor may not be that which delivers best performance. A frequency search can be performed using the Main GUI panel in the ELLO software, or by using the serial communication line (SEARCHFREQ\_MOTORX message), which offers a way to optimize the operating frequencies for backward and forward movement.

This search can also be performed manually by restoring the factory settings as described in section 4.5. below.

### 4.5 Restoring Factory Settings

Factory settings can be restored during the start up (calibration) test as follows:

*With the remote handset*

1. Remove all power (USB and PSU) from the stage.
2. Press and hold BW button.
3. Power up the slider.
4. The slider performs a self-test by moving from one position to the other. If the slider does not move or complete, move the slider manually from one end of travel to the other until it is no longer attempting to move.
5. Note: The BW button must be held down during manual actuation.
6. Release the BW button. The red INM LED (LED 2 see [Figure 5](#)) should be lit briefly.
7. A frequency search will now be performed. To avoid overheating the motor, a pause of 1 second is programmed after each move. The red INM LED will be lit after each movement
8. Press and hold the BW button until red INM LED turns ON and then OFF, and the slider stops moving. The optimized resonating frequency is stored until the next frequency search is requested.
9. Power down the slider.
10. Wait for the green PWR LED to turn OFF.
11. Power up the slider. The device will now complete a self test.

*Without the remote handset*

1. Connect Pin 6 of connector J2 to 0V.
2. With J2 Pin 6 connected to 0V, power up the slider.
3. The slider performs a self-test by moving from one position to the other. If the slider does not move or complete, then move the slider manually from one end of travel to the other until it is no longer attempting to move.

Note: J2 Pin 6 will need to be shorted to 0V during manual actuation.

4. Connect J2 Pin 6 to 3.3V.
5. A frequency search will now be performed. To avoid overheating the motor, a pause of 1 second is programmed after each move.
6. Connect J2 Pin 6 to 0V. The slider stops moving and the optimized resonating frequency is stored until the next frequency search is requested.
7. Power down the slider
8. Wait for 1 second for power supply line to go to 0V.
9. Power up the slider. The device will now complete a self test.

## 4.6 Simultaneous Movement of Devices

If more than one device is connected to the comms bus, movement of the devices can be synchronized. This can be achieved either by using the handset, or by software. See the protocol document for details on how to use the 'ga' message to synchronize moves. If using the handset, synchronized movement is hard wired, so if multiple devices are connected, pressing the FWD or BWD buttons will move all devices.

## Chapter 5 Troubleshooting and FAQ

### 5.1 Frequently Asked Questions

#### Stage is moving back and forth after power up

If the digital line "bw" is driven low before powering up the stage, the module will go into calibration mode. Remove power to exit calibration mode. Keep line tight up to 3.3V or 5V rail during power up or use a serial communication line instead.

#### Stage not moving

Check power supply lines ratings (polarity, voltage drop or range, available current) or reduce cable length.

Check module is not in boot loader mode (power cycle the module to exit boot loader) consumption must be higher than 36mA at 5V.

#### Stage does not complete homing commands

Power cycle the unit.

Perform a frequency search on both motors.

#### Stage switching time increased / max load decreased

Check power supply voltage provided on J2 connector (see [Figure 8](#)), increase voltage within specified limits if voltage drop along cable goes below 5V during system operation.

Clean the moving surfaces. To avoid grease contamination, do not touch the moving parts.

Temperature change may affect the stage performance. Using the software to perform a frequency search will compensate frequency as needed (required current could reach 1.2 A during frequency search, use an additional 5V 2A power supply and a USB connection).

Integrators should search for optimal frequency on every power up sequence (commands "s1", "s2" see ELLx protocol document)

#### How do I restore the factory (default) settings

Factory settings can be restored at any time – see [Section 4.5](#).

#### What is the product lifetime

Product lifetime is restricted by the wearing of moving surfaces and the motor contact as motion is started (due to resonance build up) and performed (due to friction), and is expressed in km travelled. Lifetime will depend on several factors (e.g. load, number of homing operations, number of frequency searches etc.) and users must take into account all these factors when considering life time. For example, homing requires more travel than a simple motion, and a frequency search may not generate any motion at all, but still energizes the motors fully.

The unit is not designed for continuous operation. Users should aim for a duty cycle of less than 40% wherever possible, and never exceed a duty cycle of 60% for longer than a few seconds.

The minimum lifetime is 100 km.

#### Handling



#### Warning

The equipment is susceptible to damage from electrostatic discharge. When handling the device, anti-static precautions must be taken and suitable discharge appliances must be worn.

The stage and interface board are robust to general handling. To ensure reliable operation, keep the surface of the plastic track contacted by the motors free of oils, dirt, and dust. It is not necessary to wear gloves while handling the stage, but avoid touching the track to keep it free of oils from fingerprints. If it is necessary to clean the track, it may be wiped with isopropyl alcohol or mineral spirits (white spirit). Do not use acetone, as this solvent will damage the plastic track.



## 5.2 Notes on Making a Picoflex Cable for Use when Daisy Chaining Devices

The multi-drop communications bus offers the option of connecting the stage to a hybrid network of up to 16 Elliptec resonant motor products and controlling the connected units with a device such as a microprocessor. When multiple units are connected to the same interface board, all can be controlled simultaneously using either the software or the buttons on the interface board.

When making a cable to operate multiple devices it is important to observe the correct pin orientation. The following procedure offers guidance in making such a cable.

1. Gather together the parts required.
  - a) Ribbon cable 3M 3365/08-100 (Farnell 2064465xxxx).
  - b) Female crimped connectors as required - model number MOLEX 90327-0308 (Farnell order code 673160) (Qty 1 female connector above is shipped with each stage unit).
  - c) Suitable screwdriver and scissors or other cutting tool.

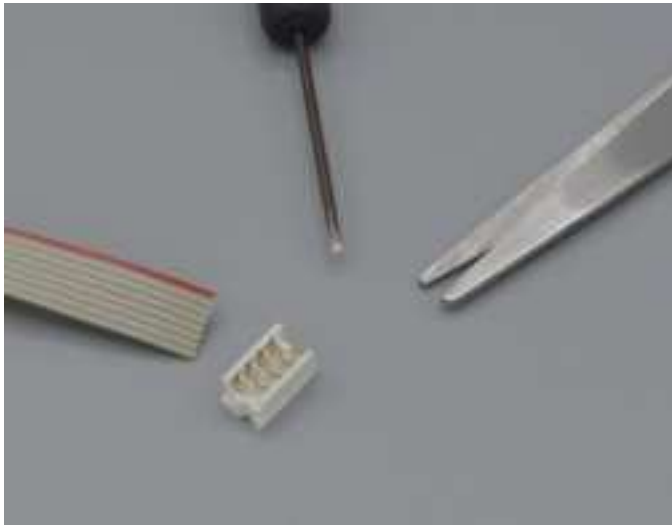

2. Orientate the first connector correctly to mate with the connector on the stage, then arrange the ribbon cable as shown with the red wire aligned with pin 1 (identified on the pcb by a small triangle). Slide the connector onto the ribbon cable as shown.

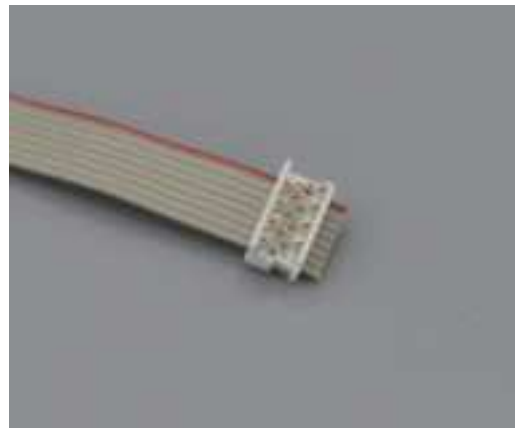
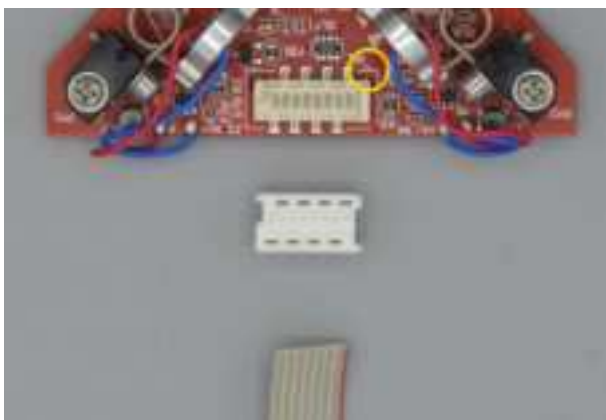

- Using a screwdriver or other suitable tool, push down the crimp of each pin to make connection with the ribbon cable.

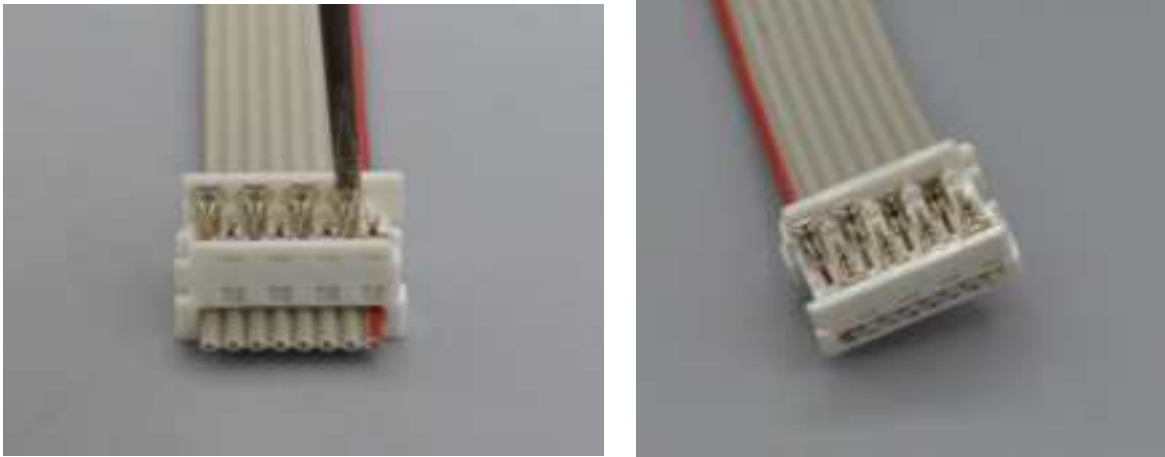

- If other connectors are required they should be fitted at this point. Slide each connector onto the cable, paying attention to the orientation as shown below, then crimp as detailed in step (3).

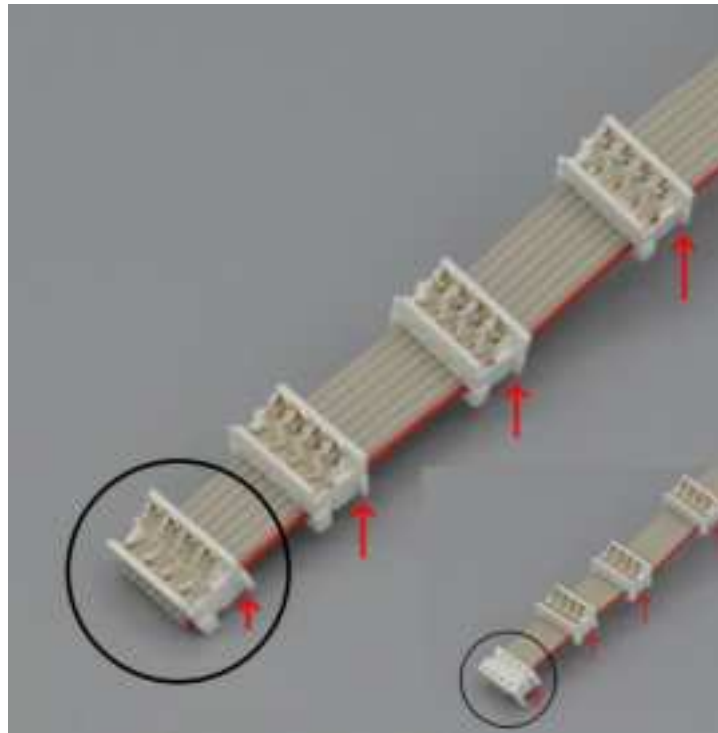

- Fit the terminating connector which will mate with the interface board, taking care to align the cable red wire with pin 1 as detailed in step (2).

## Chapter 6 Specifications

Item #	ELL6(K)	ELL9(K)	ELL12(K)
<b>Switching Time Between Two Positions</b>	Unloaded 180 to 270 ms 100 g Load <600 ms	Unloaded 450 to 500 ms 150 g Load <700 ms	Unloaded 350 to 400 ms 150 g Load <600 ms
<b>Travel</b>	31 mm (1.22")	93 mm (3.66")	95 mm (3.74")
<b>Optic Mounting Positions</b>	Two SM1 (1.035"-20) Threads	Four SM1 (1.035"-20) Threads	Four SM05 (0.535"-20) Threads
<b>Positioning Repeatability <sup>a</sup></b>	<100 $\mu$ m (30 $\mu$ m Typical)		
<b>Maximum Load (Vertically Mounted) <sup>b</sup></b>	150 g (5.29 oz)		
<b>Minimum Lifetime <sup>c</sup></b>	100 km (3.3 Million Operations)		
<b>Rated Voltage</b>	4.5 to 5.5 V		
<b>Typical Current Consumption, During Movement</b>	<600 mA	<1200 mA	<1200 mA
<b>Typical Current Consumption, During Standby</b>	38 mA		
<b>Typical Current Consumption, During Frequency Search <sup>d</sup></b>	1.2 A		
<b>Bus <sup>e</sup></b>	Multi-Drop 3.3V/5V TTL RS232		
<b>Speed</b>	9600 baud/s		
<b>Data Length <sup>f</sup></b>	8 bit		
<b>Protocol Data Format</b>	ASCII HEX		
<b>Module Address and Command Format</b>	Mnemonic Character		
<b>Ribbon Cable Length (Supplied)</b>	250 mm		
<b>Ribbon Cable Length (Max)</b>	3 m		
<b>Dimensions of the Slider (at end stops)</b>	79.0 mm x 77.7 mm x 14.0 mm (3.11" x 3.06" x 0.55")	143.5 mm x 77.7 mm x 14.2 mm (5.65" x 3.06" x 0.56")	143.5 mm x 77.7 mm x 14.2 mm (5.65" x 3.06" x 0.56")
<b>Dimensions of the Control Board</b>	32.0 mm x 65.0 mm x 12.5 mm (1.26" x 2.56" x 0.49")		
<b>Weight: Slider unit only (no cables or handset)</b>	44.0 g (1.55 oz)	70.0 g (2.47 oz)	78.5 g (2.77 oz)
<b>Weight: Interface Board</b>	10.3 g (0.36 oz)		

### Notes

- a. Low power infrared photo-sensor technology aligns the slider at each position.
- b. Vertically Mounted so that Movement is Side-to-Side and not Up-and-Down
- c. Lifetime is measured in terms of distance traveled by the optics mount. One operation is defined as a movement from one position to an adjacent position.
- d. Additional Power Supply May Be Required
- e. Use two 10 k $\Omega$  pull-up resistors in multi-drop mode for RX/TX.
- f. 1 Stop Bit, No Parity

## Chapter 7 Regulatory

### 7.1 Declarations of Conformity

#### 7.1.1 For Customers in Europe



# THORLABS

www.thorlabs.com

## EU Declaration of Conformity

in accordance with EN ISO 17050-1:2010

We: Thorlabs Ltd.  
 Of: 204 Lancaster Way Business Park, Ely, CB6 3NX, UK

In accordance with the following Directive(s):

2006/42/EC	Machinery Directive (MD)
2014/30/EU	Electromagnetic Compatibility (EMC) Directive
2011/65/EU	Restriction of Use of Certain Hazardous Substances (RoHS)

hereby declare that:

Model: **ELL6, ELL6K, ELL9, ELL9K ELL12 and ELL12K**

Equipment: **Multi- Position sliders**

is/are in conformity with the applicable requirements of the following documents:

EN ISO 12100	Safety of Machinery. General Principles for Design. Risk Assessment and Risk Reduction	2010
Authorised to compile the technical file: Thorlabs GmbH Münchner Weg 1, 85232 Bergkirchen, Deutschland		
EN 61326-1	Electrical Equipment for Measurement, Control and Laboratory Use - EMC Requirements	2013

and which, issued under the sole responsibility of Thorlabs, is/are in conformity with Directive 2011/65/EU of the European Parliament and of the Council of 8th June 2011 on the restriction of the use of certain hazardous substances in electrical and electronic equipment, for the reason stated below:

contains no substances in excess of the maximum concentration values tolerated by weight in homogenous materials as listed in Annex II of the Directive

I hereby declare that the equipment named has been designed to comply with the relevant sections of the above referenced specifications, and complies with all applicable Essential Requirements of the Directives.

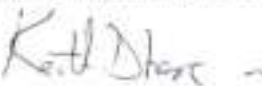
Signed:  On: 24 September 2021

Name: Keith Dhese  
 Position: General Manager

  
EMC - ELL6, ELL6K, ELL9, ELL9K ELL12 or

### **7.1.2 For Customers In The USA**

This equipment has been tested and found to comply with the limits for a Class A digital device, pursuant to part 15 of the FCC rules. These limits are designed to provide reasonable protection against harmful interference when the equipment is operated in a commercial environment. This equipment generates, uses and can radiate radio frequency energy and, if not installed and used in accordance with the instruction manual, may cause harmful interference to radio communications. Operation of this equipment in a residential area is likely to cause harmful interference in which case the user will be required to correct the interference at his own expense.

Changes or modifications not expressly approved by the company could void the user's authority to operate the equipment.

## Chapter 8 Thorlabs Worldwide Contacts

For technical support or sales inquiries, please visit us at [www.thorlabs.com/contact](http://www.thorlabs.com/contact) for our most up-to-date contact information.



### USA, Canada, and South America

Thorlabs, Inc.  
[sales@thorlabs.com](mailto:sales@thorlabs.com)  
[techsupport@thorlabs.com](mailto:techsupport@thorlabs.com)

### Europe

Thorlabs GmbH  
[europe@thorlabs.com](mailto:europe@thorlabs.com)

### France

Thorlabs SAS  
[sales.fr@thorlabs.com](mailto:sales.fr@thorlabs.com)

### Japan

Thorlabs Japan, Inc.  
[sales@thorlabs.jp](mailto:sales@thorlabs.jp)

### UK and Ireland

Thorlabs Ltd.  
[sales.uk@thorlabs.com](mailto:sales.uk@thorlabs.com)  
[techsupport.uk@thorlabs.com](mailto:techsupport.uk@thorlabs.com)

### Scandinavia

Thorlabs Sweden AB  
[scandinavia@thorlabs.com](mailto:scandinavia@thorlabs.com)

### Brazil

Thorlabs Vendas de Fotônicos Ltda.  
[brasil@thorlabs.com](mailto:brasil@thorlabs.com)

### China

Thorlabs China  
[chinasales@thorlabs.com](mailto:chinasales@thorlabs.com)

Thorlabs verifies our compliance with the WEEE (Waste Electrical and Electronic Equipment) directive of the European Community and the corresponding national laws. Accordingly, all end users in the EC may return “end of life” Annex I category electrical and electronic equipment sold after August 13, 2005 to Thorlabs, without incurring disposal charges. Eligible units are marked with the crossed out “wheelie bin” logo (see right), were sold to and are currently owned by a company or institute within the EC, and are not disassembled or contaminated. Contact Thorlabs for more information. Waste treatment is your own responsibility. “End of life” units must be returned to Thorlabs or handed to a company specializing in waste recovery. Do not dispose of the unit in a litter bin or at a public waste disposal site.

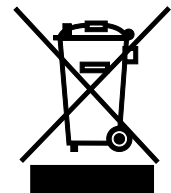

Annex I



**THORLABS**  
[www.thorlabs.com](http://www.thorlabs.com)

---