



OWNER'S MANUAL

# LG Digital Signage

## (MONITOR SIGNAGE)

---

Please read the user manual before using this product to ensure safe and convenient use.

32TNF5J

43TNF5J

55TNF5J

[www.lg.com](http://www.lg.com)

Copyright © 2021 LG Electronics Inc. All Rights Reserved.



# TABLE OF CONTENTS

<b>BASIC .....</b>	<b>3</b>
- Checking the Accessories .....	3
<b>CHECKING BEFORE INSTALLATION .....</b>	<b>4</b>
- Installation Orientation .....	4
- Installation Location.....	5
<b>PRECAUTIONS FOR USE.....</b>	<b>8</b>
- Dust.....	8
- Afterimage .....	8
<b>PRODUCT SPECIFICATIONS.....</b>	<b>10</b>
<b>LICENCE.....</b>	<b>13</b>

**WARNING** - This equipment is compliant with Class A of CISPR 32. In a residential environment this equipment may cause radio interference.

## BASIC

### ! NOTE

- The accessories provided with your product may vary depending on the model or region.
- Product specifications or contents in this manual may be changed without prior notice due to upgrade of product functions.
- SuperSign Software & Manual
  - Visit <http://partner.lge.com> to download the latest SuperSign software and manual.

## Checking the Accessories

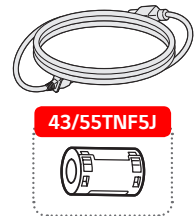
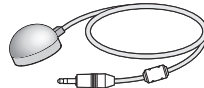
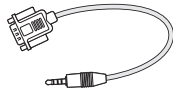
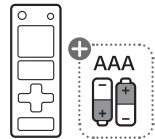
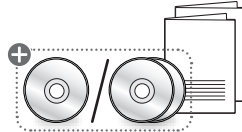

⊕: Depending on country

# CHECKING BEFORE INSTALLATION

We are not responsible for product damage caused by failure to follow the guide.

## Installation Orientation

### Using Vertically

When installing vertically, rotate the monitor 90 degrees anti-clockwise while facing the front of the screen.



### Tilt Angle



When installing the monitor, it may be tilted upward at an angle of up to 45 degrees.

## Installation Location

We are not responsible for product damage caused by failure to follow the guide.

This product is used as a built-in product installed inside the enclosure.

- The product warranty will be void if it is used with the front panel exposed to direct sunlight.
- Wear work gloves when installing the product.
- Installing the product with bare hands may cause injury.

### Indoor

#### Installing the monitor in the enclosure

If installing the product inside the enclosure, install the stand (optional) on the rear side of the product.

When installing the product using the stand (optional), attach the stand securely to the monitor to ensure it does not fall.

VESA Mount Hole

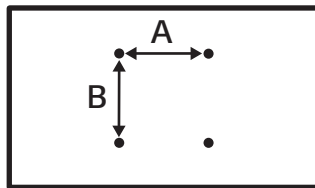

Model	VESA Dimensions (A x B) (mm)	Standard Dimensions	Length (Maximum) (mm)	Quantity
32TNF5J	200 x 200	M6	21.0	4
43TNF5J	200 x 200	M6	15.5	4
55TNF5J	300 x 300	M6	14.0	4

Side Mount Hole

Unit: mm

32TNF5J

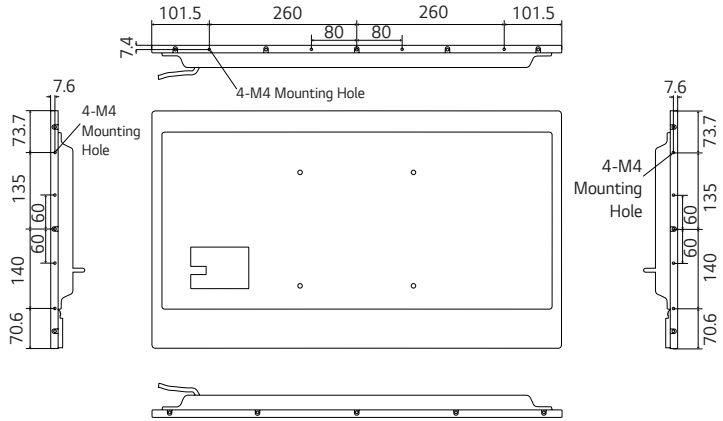

43TNF5J

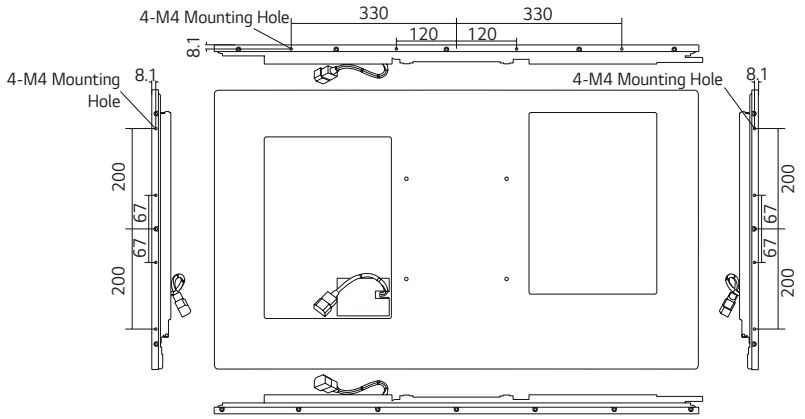

55TNF5J

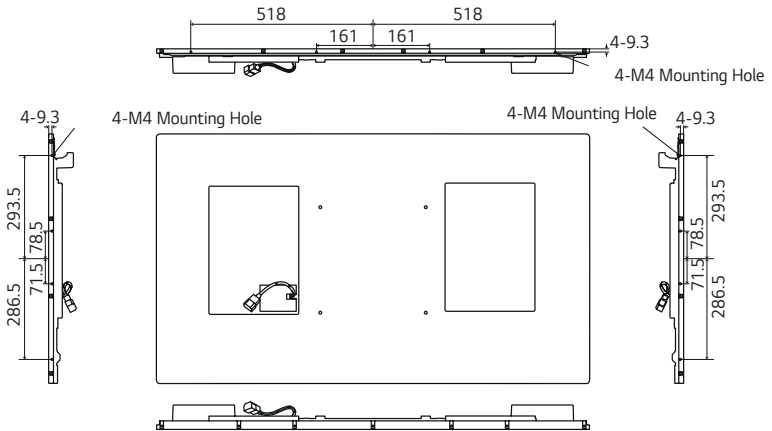

Model	Standard Dimensions	Length (Maximum) (mm)	Quantity	etc.
32TNF5J	M4	4.5	12	Top/Left/Right (4EA each)
43TNF5J	M4	4.5	12	Top/Left/Right (4EA each)
55TNF5J	M4	4.0	12	Top/Left/Right (4EA each)

- 1 Use the side screw holes when mounting the panel.
- 2 Screw tightening torque: 5~7 kgf
- 3 The screw length can be longer, depending on the enclosure shape and thickness of the material.

### CAUTION

- Disconnect the power cord first, and then move or install the monitor. Otherwise, it may result in electric shock.
- If the monitor is installed on a ceiling or inclined wall, it may fall and result in injury.
- Damage to the monitor by tightening the screws too tightly may void your warranty.
- Use screws and wall mount plates conforming to VESA standards. Breakage or personal injury due to use or misuse of inappropriate components is not covered by the warranty of this product.
- When installing the product, be careful not to apply strong force to the lower part.

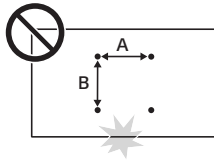

### NOTE

- Using screws longer than the indicated depth may damage the inside of the product. Be sure to use the proper length.
- For more information on installation, please refer to the user manual for the wall mount.

# PRECAUTIONS FOR USE

The Wake-up feature for sleep mode is not supported in this model.

## Dust

The warranty will not cover any damage caused by using the product in an excessively dusty environment.

## Afterimage

- After-image appears when the product is turned off.
  - Pixels may be damaged rapidly if a still image is displayed on the screen for a long period of time. Use the screen-saver function.
  - Switching from a screen with high differences in luminance (black and white or grey) to a darker screen may cause an afterimage. This is normal due to the display characteristics of this product.
- When the LCD screen is in a still pattern for extended periods of use, a slight voltage difference may occur between the electrodes that operate the liquid crystal (LC). The voltage difference between the electrodes increases over time and tends to keep the liquid crystal aligned in one direction. At this time, the previous image remains, which is called an afterimage.
- Afterimages do not occur when continuously changing images are used but take place when a certain screen is fixed for a long time. The following are operational recommendations for reducing the occurrence of afterimages when using a fixed screen. The maximum recommended time for switching the screen is 12 hours. Shorter cycles are better for preventing afterimages.
- Recommended Usage Condition



1 Change the background colour and text colour at equal intervals.

- Afterimages occur less when the colours to be changed are complementary to one another.

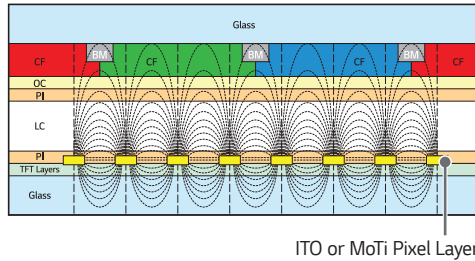

2 Switch the screen at equal time intervals.

- Take caution, and ensure that text or images from before the screen change are not left in the same location after the screen change.



# PRODUCT SPECIFICATIONS

Without prior notice, all product information and specifications contained in this manual are subject to change to improve the performance of the product.

## 32TNF5J

Input/Output Ports	HDMI1, HDMI2, IR IN, AUDIO OUT, LAN IN, RS-232 IN, TOUCH USB OUT, USB 2.0 IN	
Embedded battery	Applied	
Resolution	Recommended Resolution	1920 x 1080 @ 60 Hz (HDMI1, HDMI2)
	Max Resolution	
Power Voltage	100-240 V ~ 50/60 Hz 0.6 A	
Environmental Conditions	Operating Temperature	0 °C to 40 °C
	Operating Humidity	10 % to 80 % (Condition for preventing condensation)
	Storage Temperature	-20 °C to 60°C
	Storage Humidity	5 % to 85 % (Condition for preventing condensation) * Product box packaging storage conditions
Power Consumption	On Mode	55 W (Typ.)
	Sleep Mode / Standby Mode	≤ 0.5 W

## 43TNF5J

Input/Output Ports	HDMI1, HDMI2, IR IN, AUDIO OUT, LAN IN, RS-232 IN, TOUCH USB OUT, USB 2.0 IN	
Embedded battery	Applied	
Resolution	Recommended Resolution	3840 x 2160 @ 60 Hz (HDMI1, HDMI2)
	Max Resolution	
Power Voltage	100-240 V ~ 50/60 Hz 1.1 A	
Environmental Conditions	Operating Temperature	0 °C to 40 °C
	Operating Humidity	10 % to 80 % (Condition for preventing condensation)
	Storage Temperature	-20 °C to 60°C
	Storage Humidity	5 % to 85 % (Condition for preventing condensation) * Product box packaging storage conditions
Power Consumption	On Mode	95 W (Typ.)
	Sleep Mode / Standby Mode	≤ 0.5 W

**55TNF5J**

Input/Output Ports	HDMI1, HDMI2, IR IN, AUDIO OUT, LAN IN, RS-232 IN, TOUCH USB OUT, USB 2.0 IN	
Embedded battery	Applied	
Resolution	Recommended Resolution	3840 x 2160 @ 60 Hz (HDMI1, HDMI2)
	Max Resolution	
Power Voltage	100-240 V ~ 50/60 Hz 1.7 A	
Environmental Conditions	Operating Temperature	0 °C to 40 °C
	Operating Humidity	10 % to 80 % (Condition for preventing condensation)
	Storage Temperature	-20 °C to 60°C
	Storage Humidity	5 % to 85 % (Condition for preventing condensation) * Product box packaging storage conditions
Power Consumption	On Mode	127 W (Typ.)
	Sleep Mode / Standby Mode	≤ 0.5 W

**32/43/55TNF5J**

* Touch Screen		
OS (Operating System)	Windows 10	10 Points (Max)
	webOS	10 Points (Max)

Model Name	Dimensions (Width x Height x Depth) (mm)	Weight (kg)
32TNF5J	723 x 419.4 x 39.1	5.6
43TNF5J	967.2 x 559 x 38	10.4
55TNF5J	1231.8 x 709.6 x 39.2	16.8

**HDMI (PC) Support Mode**

Resolution	Horizontal Frequency (kHz)	Vertical Frequency (Hz)	Note
800 x 600	37.879	60.317	
1024 x 768	48.363	60	
1280 x 720	44.772	59.855	
1280 x 1024	63.981	60.02	
1680 x 1050	65.29	59.954	
1920 x 1080	67.5	60	
3840 x 2160	67.5	30	Except for 32TNF5J
	135	60	

\* We recommend using 60Hz. (Motion blur/judder may be visible on inputs other than 60Hz.)

# LICENCE

Supported licenses may differ by model. For more information of the licenses, visit [www.lg.com](http://www.lg.com).



The terms HDMI, HDMI High-Definition Multimedia Interface, and the HDMI Logo are trademarks or registered trademarks of HDMI Licensing Administrator, Inc.

Manufactured under license from Dolby Laboratories. Dolby, Dolby Vision, Dolby Vision IQ, Dolby Audio, Dolby Atmos, and the double-D symbol are trademarks of Dolby Laboratories Licensing Corporation.





The model and serial number of the product are located on the back and on one side of the product. Record them below in case you ever need service.

MODEL \_\_\_\_\_

SERIAL NO. \_\_\_\_\_

Temporary noise is normal when powering ON or OFF this device.