

# YOUR RELIABLE INDOOR GROW PARTNER

Follow Us on Social Media



Email:  
support@spider-farmer.com  
info@spider-farmer.com

折疊線

折疊線

## INSTRUCCIONES DE MONTAJE ES

Siga los pasos en el orden indicado.

### 1. Instalación del mango

Alinee el mango con el orificio de montaje e insértelo. No es necesario atornillarlo.

### 2. Reemplazo de cuchilla

1. Use siempre guantes al reemplazar cuchillas.
2. Retire el tornillo y saque con cuidado la cuchilla original.
3. Coloque la nueva cuchilla y apriete firmemente el tornillo.

### ADVERTENCIA DE SEGURIDAD

Las cuchillas son extremadamente afiladas. Use siempre guantes protectores para evitar lesiones.

## MONTEERINSTRUCTIES NL

Volg onderstaande stappen in de juiste volgorde.

### 1. Handgreep installatie

Plaats de handgreep in het montagegat zonder te schroeven.

### 2. Mesvervangng

1. Draag altijd handschoenen bij mesvervangng.
2. Verwijder de schroef en haal voorzichtig het oorspronkelijke mes eruit.
3. Plaats het nieuwe mes en draai de schroef stevig vast.

### VEILIGHEIDSWAARSCHUWING

De messen zijn extreem scherp. Draag altijd beschermende handschoenen om verwondingen te voorkomen.

折疊線

折疊線





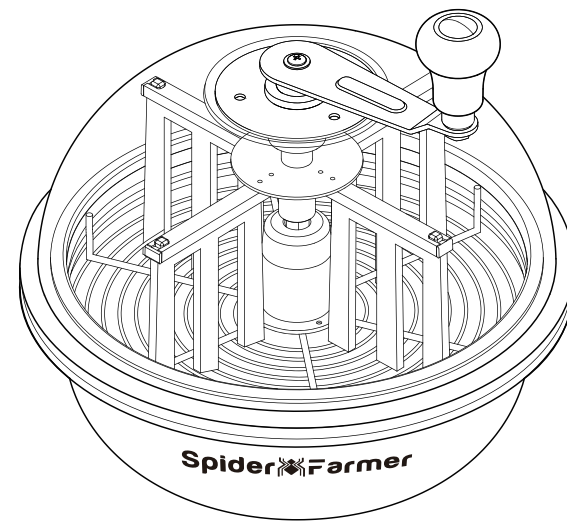



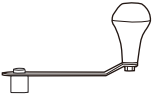

# Spider Farmer USER MANUAL

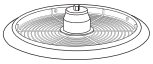
## Leaf Bowl Trimmer

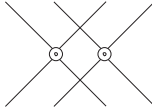

SF-Leaf Bowl Trimmer-01

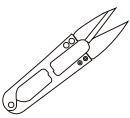
## ACCESSORIES (13"/16"Leaf Bowl Trimmer)

		
Hand Crank x1	Arc Cover x1	Silicone Strips x1 13": 4 rows of 3 strips 16": 8 rows of 3 strips
		
Mesh Filter Disc x1	Stainless Steel Basin (4 feet) x1	Cross Blade x2
		
Flat Blade x2	Serrated Blade x1	Gloves x1
		
Small Scissors x1	Screwdriver x1	Pruning Shears x1

1

## ASSEMBLY INSTRUCTIONS

Please follow the steps below in the correct order.

### 1. Handle Installation

Align the handle with the mounting hole and insert it. There is no need to screw it in.

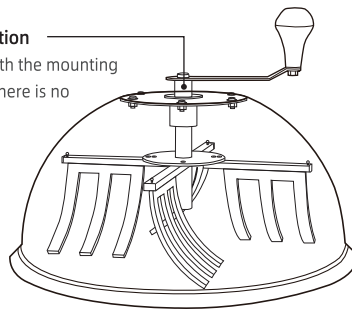

折疊線

### 2. Blade Replacement

1. Always wear gloves when replacing blades.
2. Remove the screw and carefully take out the original blade.
3. Position the new blade and securely tighten the screw.

### SAFETY WARNING

The blades are extremely sharp. Always wear protective gloves when handling or replacing blades to prevent injury.

2

## MONTAGEANLEITUNG

DE

Bitte führen Sie die Schritte in der richtigen Reihenfolge aus.

### 1. Griffinstallation

Griff mit der Montagebohrung ausrichten und einsetzen. Ein Anschrauben ist nicht erforderlich.

### 2. Klingenwechsel

1. Beim Klingenwechsel stets Handschuhe tragen.
2. Schraube entfernen und Originalklinge vorsichtig entnehmen.
3. Neue Klinge positionieren und Schraube fest anziehen.

### SICHERHEITSHINWEIS

Die Klingen sind extrem scharf. Tragen Sie stets Schutzhandschuhe beim Umgang mit Klingen, um Verletzungen zu vermeiden.

折疊線

## INSTRUCTIONS DE MONTAGE

FR

Veuillez suivre les étapes dans l'ordre indiqué.

### 1. Installation de la poignée

Aligner la poignée avec le trou de montage et l'insérer. Aucun vissage n'est nécessaire.

### 2. Remplacement de la lame

1. Portez toujours des gants pour remplacer les lames.
2. Retirez la vis et retirez délicatement la lame d'origine.
3. Positionnez la nouvelle lame et serrez fermement la vis.

### AVERTISSEMENT DE SÉCURITÉ

Les lames sont extrêmement tranchantes. Portez toujours des gants de protection pour éviter les blessures.

折疊線

## ISTRUZIONI DI MONTAGGIO

IT

Seguire i passaggi nell'ordine corretto.

### 1. Installazione della maniglia

Allineare la maniglia con il foro di montaggio e inserirla. Non è necessario avvitarla.

### 2. Sostituzione della lama

1. Indossare sempre i guanti quando si sostituiscono le lame.
2. Rimuovere la vite ed estrarre con cautela la lama originale.
3. Posizionare la nuova lama e serrare saldamente la vite.

### AVVERTENZA DI SICUREZZA

Le lame sono estremamente affilate. Indossare sempre guanti protettivi per prevenire lesioni.

3