



TRUE RESIDENTIAL®

TR-30 / TR-36
INSTALL GUIDE AND USER'S MANUAL
"C" REVISION



PRESERVE THE MOMENT®



212530

THANK YOU

FOR YOUR PURCHASE

INSTALLATION CHECKLIST

To ensure no part of the installation process has been overlooked, complete the checklist below.

- Have all packaging materials been removed?
- Are the anti-tip brackets securely installed and properly engaging the unit?
- Has the unit been properly leveled? Do all leveling legs touch the floor?
- Is the kickplate installed?
- Is the doorstop being installed (if needed)?
- Does the customer understand the unit's operation?
- Has the customer been given the key and literature package?
- Have all stainless steel surfaces been inspected for imperfections?*
- Is the unit operating correctly? If not, is the unit plugged in? Is the control turned on?

*To be completed by either an installer with the customer or an authorized True dealer upon completion of installation. Stainless steel doors, handles, and shelves are covered by a limited 30-day warranty for cosmetic defects.

CONTENTS

SAFETY INFORMATION & OWNERSHIP

REFRIGERANT SAFETY & WARNING INFORMATION	8
BASIC SAFETY & WARNING PRECAUTIONS	8
CABINET DISPOSAL WARNING	9
OWNERSHIP	10
NOTICE TO CUSTOMER	10
REGISTER YOUR PRODUCT	10
SERIAL LABEL LOCATION	10
CONTACT INFORMATION	10

PRIOR TO INSTALLATION

ROUGH OPENINGS & PLAN VIEWS	12
ANTI-SWEAT FOAM END PANELS	14
ELECTRICAL SAFETY	15
OPTIONAL ICEMAKER REQUIREMENTS (TR-30FRZ/36FRZ-IM-C)	17
WINE RACK HANDLE FINISH APPLICATION (TR-30DZW)	20

SIDE-BY-SIDE INSTALLATION PLAN VIEWS

TR-30 / TR-42	22
TR-30 /TR-48	23
TR-30 / TR-30	24
TR-30 / TR-30 / TR-30	25
TR-36REF / TR-36REF	26
TR-36REF / TR-30REF	27

INSTALLATION

UNCRATING	30
ANTI-TIP BRACKET INSTALLATION	33
LEVELING	34
KICKPLATE INSTALLATION	35
JOINING KIT INSTALLATION	36

CABINET SETUP

SHELVING, BINS, DRAWERS	42
REFRIGERATOR STORAGE	42
FREEZER STORAGE	45
OPTIONAL ICEMAKER	46

REFRIGERATOR/FREEZER ELECTRONIC CONTROL OPERATION

TURN ON/OFF	48
TEMPERATURE ADJUSTMENT	49
MODE NAVIGATION	50
SHOWROOM MODE	51
ACCENT LIGHTING SYSTEM	52
ALARM NAVIGATION	53
NOTIFICATION ALERTS	54
ICE MENU NAVIGATION	55

CONTENTS

DUAL ZONE OPERATION

TURN ON/OFF	58
TEMPERATURE ADJUSTMENT	59
MODE NAVIGATION	60
SHOWROOM MODE	61
ACCENT LIGHTING SYSTEM	62
CHANGE TRULUMINA® LIGHT COLOR	62
ALARM NAVIGATION	63
NOTIFICATION ALERTS	64

MAINTENANCE, CARE & CLEANING

DOOR REMOVAL	66
CONDENSER COIL CLEANING	67
CONDENSATION	67
HANDLE TIGHTENING	67
WATER FILTER REPLACEMENT (OPTIONAL ICEMAKER ONLY)	68
STAINLESS STEEL EQUIPMENT CARE & CLEANING	69
SERIAL LABEL LOCATION	71
CONTACT US	71

WARRANTY

WARRANTY	75
----------	----

NOTE: AS WE STRIVE FOR CONTINUOUS IMPROVEMENTS, FEATURES AND SPECIFICATIONS ARE SUBJECT TO CHANGE WITHOUT NOTICE.

30 & 36 INCH REFRIGERATOR, FREEZER & DUAL ZONE COLUMN

30" REFRIGERATOR
BEVERAGE COLUMN

STAINLESS GLASS DOOR



30" REFRIGERATOR
COLUMN

STAINLESS SOLID DOOR



30" REFRIGERATOR
COLUMN

STAINLESS GLASS DOOR



30" FREEZER
COLUMN

STAINLESS SOLID DOOR



30" DUAL ZONE
WINE COLUMN

STAINLESS GLASS DOOR



x150

LUXURY REFRIGERATION WITH COMMERCIAL DNA.

36" REFRIGERATOR
COLUMN

STAINLESS SOLID DOOR



36" REFRIGERATOR
COLUMN

STAINLESS GLASS DOOR



36" FREEZER
COLUMN

STAINLESS SOLID DOOR



NOTES

Ruled area for taking notes, consisting of multiple horizontal lines.

REFRIGERANT SAFETY & WARNING INFORMATION

BASIC SAFETY & WARNING PRECAUTIONS

CABINET DISPOSAL WARNING

PROPER DISPOSAL OF THE CABINET

OWNERSHIP

NOTICE TO CUSTOMER

REGISTER YOUR PRODUCT

SERIAL LABEL LOCATION

CONTACT INFORMATION



PRESERVE THE MOMENT®



WARNING! Use this appliance for its intended purpose as described in this Installation Manual.

REFRIGERANT SAFETY & WARNING INFORMATION

See the serial label inside the cabinet for the units refrigeration type. For Hydrocarbon Refrigeration (R290 only), see below:



DANGER! Risk of fire or explosion. Flammable refrigerant used. **DO NOT** use mechanical devices to defrost refrigerator. **DO NOT** puncture refrigerant tubing; follow handling instructions carefully. To be repaired only by trained service personnel.



DANGER! Risk of fire or explosion (flammable refrigerant used), consult repair manual/owner's guide before attempting to service this product. All safety precautions must be followed. Dispose of properly in accordance with local and federal regulations. Follow all safety precautions.



CAUTION! Keep all ventilation openings clear of obstruction in the appliance enclosure or in the structure housing the appliance.

BASIC SAFETY & WARNING PRECAUTIONS

- Take care during operation, maintenance or repairs to avoid cuts or pinching from any part/component of the cabinet.
- Units may pose a tipping hazard while uncrating, during installation, or when moving the unit.
- Ensure the unit is properly installed and located in accordance with the Installation Instructions before use.
- This appliance is not to be used, cleaned or maintained by persons (including children) with reduced physical, sensory or mental capabilities or lack of experience and knowledge, unless they have been given supervision or instruction.
- **DO NOT** allow children to play with the appliance or climb, stand, or hang on the unit's shelves to prevent damage to the refrigerator and personal injury.
- **DO NOT** touch the cold surfaces in the freezer compartment when hands are damp or wet. Skin may stick to these extremely cold surfaces.
- Unplug the refrigerator before cleaning and making repairs.
- Setting temperature controls to the 0 position or powering off an electronic control may not remove power from all components (e.g., light circuits, perimeter heaters, and evaporator fans).
- **DO NOT** store or use gasoline, or other flammable vapors and liquids, in the vicinity of this or any other appliance.

- **DO NOT** store explosive substances such as aerosol cans with a flammable propellant in this appliance.
- Keep fingers out of the "pinch point" areas; clearances between the doors and cabinet are necessarily small; be careful closing doors when children are in the area.
- **DO NOT** use electrical appliances inside the food storage compartments of the units unless the appliances are of the type recommended by the manufacturer.

NOTE: ALL SERVICING MUST BE PERFORMED BY A QUALIFIED TECHNICIAN.

CABINET DISPOSAL WARNING



DANGER! RISK OF CHILD ENTRAPMENT



PROPER DISPOSAL OF THE CABINET

Child entrapment and suffocation are not problems of the past. Junked or abandoned refrigerators are still dangerous, even if they will sit for "just a few days." If you are getting rid of your old refrigerator, please follow the instructions below to help prevent accidents.

Before throwing away your old refrigerator or freezer:

- Take off the doors.
- Leave the shelves in place so that children may not easily climb inside.



DANGER! Risk of fire or explosion. Flammable insulation and/or refrigerant used. Dispose of all in accordance with local and federal regulations. Follow all safety precautions.

OWNERSHIP

To ensure that your unit works properly from the first day, it must be installed properly. We highly recommend a trained refrigeration mechanic and electrician install your True equipment. The cost of a professional installation is money well spent.

This appliance is intended to be used in household and similar applications such as:

- Staff kitchen areas in shops, offices and other working environments;
- Bed and breakfast type environments;
- Catering and similar non-retail applications.

Before you start to install your TRUE unit, carefully inspect it for freight damage. **IF DAMAGE IS DISCOVERED, DO NOT INSTALL THE UNIT OR PUT IT IN SERVICE.** Notify True customer service and immediately file a claim with the delivery freight carrier.

TRUE is not responsible for damage incurred during shipment.

For any questions about installation, please contact your True dealer or True Residential Technical Service at **844-746-9423** or **TrueResidentialService@TrueMfg.com**. Please have your model and serial number available.

NOTICE TO CUSTOMER

Loss or spoilage of products in your refrigerator/freezer is **not covered by warranty**. In addition to following recommended installation procedures, run the refrigerator/freezer for 24 hours prior to usage to verify its proper operation.



REGISTER YOUR PRODUCT

To qualify for TRUE's extended 7–12 year parts only sealed system warranty, you must register your product* within 12 months of the unit's installation date. To register your unit, complete and submit the form at <https://www.true-residential.com/product-registration>. For warranty details, please see page 75.



* Please note that ice machines do not qualify for this extended warranty.

SERIAL LABEL LOCATION

The serial label is located on the left wall near the freezer wire basket or the refrigerator upper drawer. See fig. 1.

This label contains important information such as your model name and serial number. Please have this information on hand when contacting True so we can better assist you with your service- or parts-related inquiries.



FIG. 1. Serial label location.

CONTACT INFORMATION

CUSTOMER SERVICE

Phone: 888-616-8783
info@true-residential.com

WARRANTY DEPARTMENT

Phone: 844-849-6179
TrueResidentialWarranty@truemfg.com

SERVICE DEPARTMENT

Phone: 844-746-9423
TrueResidentialService@truemfg.com

ROUGH OPENINGS & PLAN VIEWS

ANTI-SWEAT FOAM END PANELS

ELECTRICAL SAFETY

POWER CORD

OPTIONAL ICEMAKER REQUIREMENTS (TR-30FRZ/36FRZ-IM-C)

WIRE RACK HANDLE FINISH APPLICATION (TR-30DZW)



PRESERVE THE MOMENT®

ROUGH OPENINGS & PLAN VIEWS

NOTE: DUE TO THE WEIGHT OF THIS UNIT, TRUE RECOMMENDS CONSULTING A FLOORING EXPERT PRIOR TO INSTALLATION. THE FLOORING BENEATH THE UNIT SHOULD BE RATED TO SUPPORT ≥ 150 LBS/FT² (732.36 KG/M²)

NOTE: IT IS NOT RECOMMENDED TO INSTALL UNITS SIDE BY SIDE WITH HINGES TOUCHING EACH OTHER. IF YOU PLAN TO INSTALL UNITS HINGE TO HINGE, CALL TECH SUPPORT AT 844-746-9423 FOR INSTALLATION INSTRUCTIONS.

Flush installation: The front face of the unit is flush with the surrounding cabinets

Proud (standard) Installation: The front face of the unit extends beyond the surrounding cabinets

TR-30/36 – TOP VIEW FLUSH INSTALL

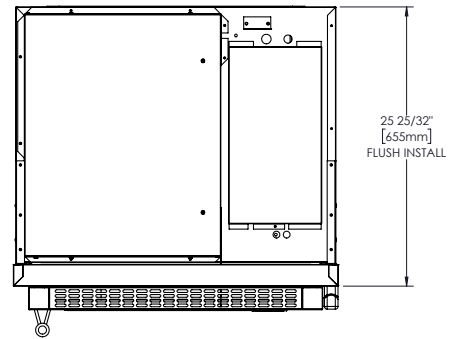

TR-30/36 – TOP VIEW PROUD INSTALL

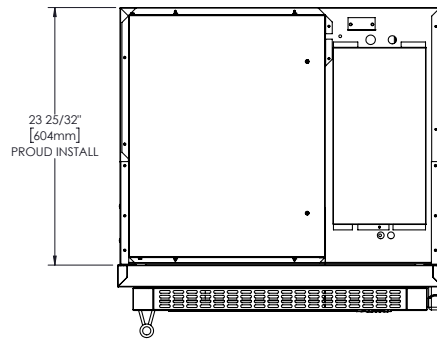

TR-30 Rough Opening Dimensions

	Flush Install	Proud Install
Width	30-1/4" (768.35 mm)	29-3/4" (755.65 mm)
Depth	25-25/32" (654.84 mm)	23-25/32" (604.04 mm)
Height	84-1/4" (2,139.95 mm)	84" (2,133.6 mm)

TR-36 Rough Opening Dimensions

	Flush Install	Proud Install
Width	36-1/4" (920.75 mm)	35-3/4" (908.05 mm)
Depth	25-25/32" (654.84 mm)	23-25/32" (604.04 mm)
Height	84-1/4" (2,139.95 mm)	84" (2,133.6 mm)

Dimensions may vary by $\pm 1/8"$ (3.2 mm)

TR-30/36 – FRONT VIEW
ROUGH OPENING & ELECTRIC AREA

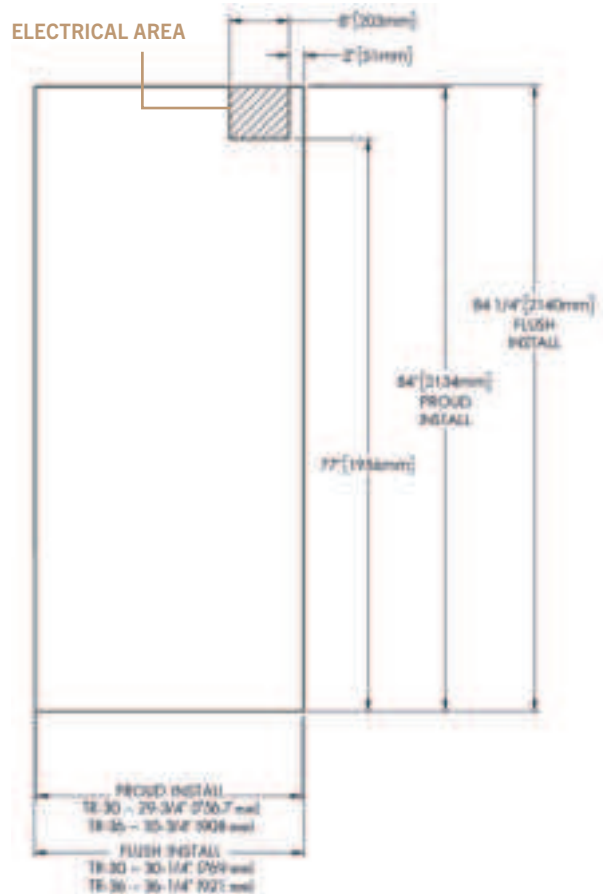

PRIOR TO INSTALLATION

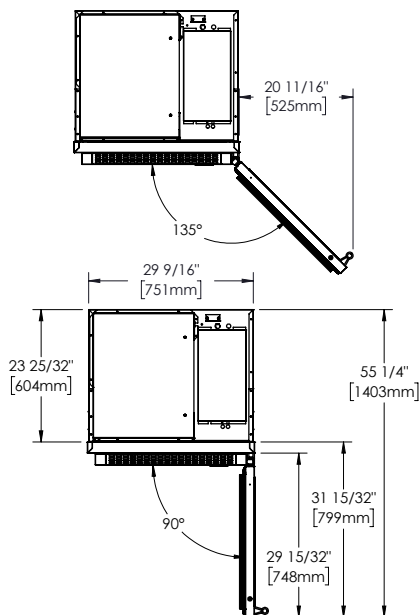

TR-30 – TOP VIEW

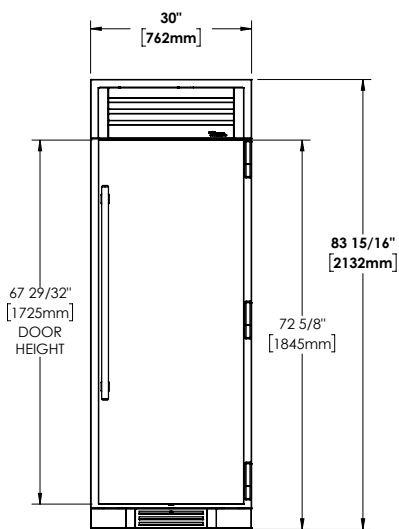

TR-30 – FRONT VIEW

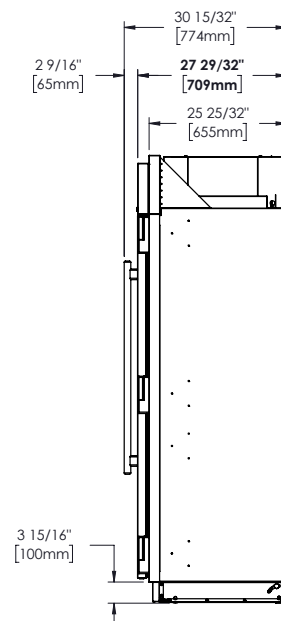

TR-30 – SIDE VIEW

Dimensions may vary by ± 1/8" (3.2 mm)

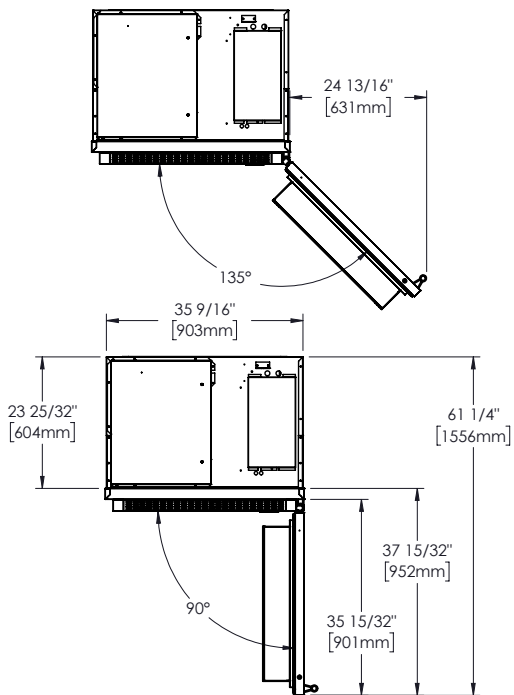

TR-36 – TOP VIEW

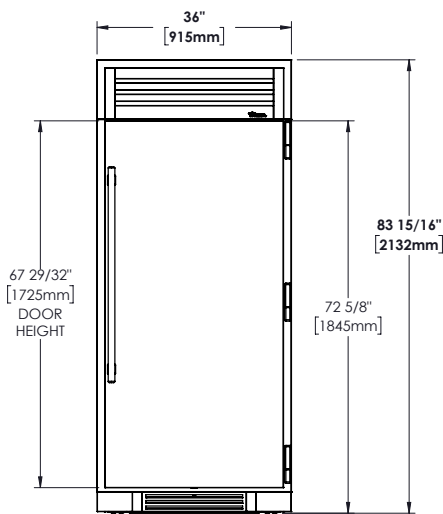

TR-36 – FRONT VIEW

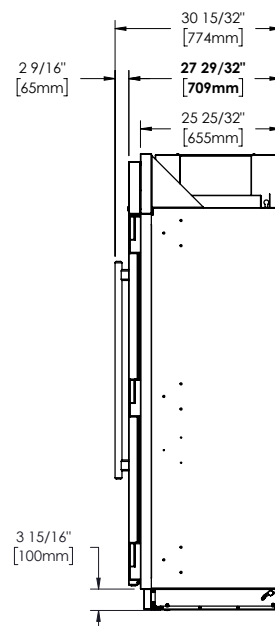

TR-36 – SIDE VIEW

Dimensions may vary by ± 1/8" (3.2 mm)

ANTI-SWEAT FOAM END PANELS

When installing two or more True units side-by-side, be sure to leave at least a 5/8" (15.88 mm) gap between the cabinets, or install foam pads between the cabinets and on any side without this gap, to prevent moisture from developing on applications.

If installing anti-sweat foam end panels, True recommends applying a panel to each of the units being joined together. To order foam pads, contact our parts department at 844-849-6226 or TrueResidentialParts@TrueMfg.com.

ELECTRICAL SAFETY

Power Supply: 115VAC, 60hz

Circuit Breaker: 15 Amp

Receptacle: 3-Prong Grounding-Type

- For all built-in models, the electrical supply should be located within the indicated shaded area shown in the figure below.
- Be sure to follow the National Electrical Code, as well as local codes and ordinances, when installing the receptacle.
- A ground fault circuit interrupter (GFCI) is not recommended and may cause interruption of operation.
- The power cord from this appliance is equipped with a grounding plug which minimizes the possibility of electric shock hazard.
- The wall outlet and circuit should be checked by a licensed electrician to be sure the outlet is wired with the correct polarity and properly grounded.
- If the outlet is a standard 2-prong outlet, it is your personal responsibility and obligation to have it replaced with a properly grounded wall outlet.
- **DO NOT**, under any circumstances, cut or remove the ground prong from the power cord. For personal safety, this appliance must be properly grounded.
- The refrigerator/freezer should always be plugged into a dedicated electrical circuit. This provides the best performance and prevents building wiring circuits from overloaded, which could cause a fire hazard from overheated wires.

- **NEVER USE AN ADAPTER PLUG!**

An adapter plug alters the original equipment manufacturer (OEM) plug configuration when connecting it to a power source. True will not warranty any refrigerator/freezer that has been connected to an adapter plug.



- **NEVER USE AN EXTENSION**

CORD! An extension cord is any component that adds length to the OEM power cord when connecting it to a power source. True will not warranty any refrigerator/freezer that has been connected to an extension cord.



- Before your new unit is connected to a power supply, check the incoming voltage. If the recorded voltage is less than the rated voltage for operation (+/-5%) and amp rating, correct immediately. Refer to the serial label for this voltage requirement.
- **NEVER** unplug your refrigerator/freezer by pulling on the power cord. Always grip the plug firmly and pull straight from the outlet.
- When moving the refrigerator/freezer for any reason, take care to no roll over or damage the power cord.
- Immediately repair or replace all power cords that have become frayed or otherwise damaged. **DO NOT** use a power cord that shows cracks or abrasion damage along its length or at either end.
- If the supply power cord is damaged, replace it with OEM components. To avoid hazard, this should be done by a licensed service provider or similarly qualified person.

SITE PREPARATION

POWER CORD

INSTALLATION

Fully seat the power cord into the cabinet receptacle until it locks in position. See fig. 1.

REMOVAL

Depress the red button. See fig. 2.

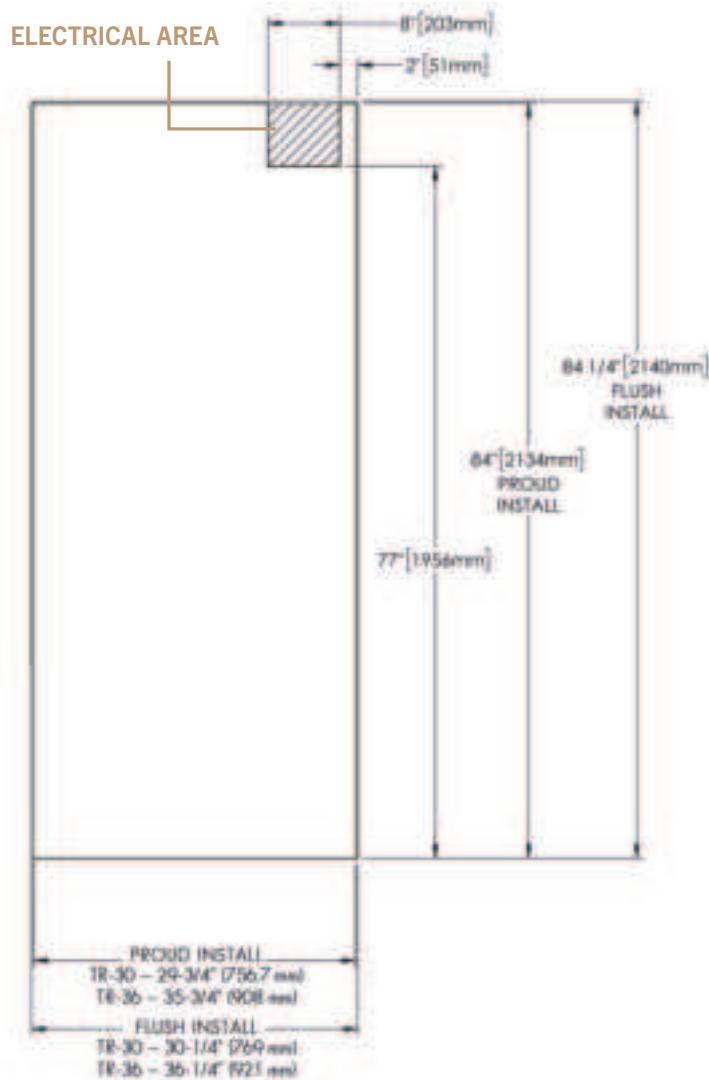

FIG. 1. Fully insert the power cord into the receptacle.



FIG. 2. Push the red button to remove the plug.

TR-30/36 FRONT VIEW ROUGH OPENING & ELECTRICAL AREA



NOTE: DIMENSIONS MAY VARY BY $\pm 1/8"$ (3.175 mm)

OPTIONAL ICEMAKER REQUIREMENTS (TR-30FRZ/36FRZ-IM-C)

WATER SUPPLY REQUIREMENTS

Units with optional ice makers come with 20" (508 mm) of polyethylene tubing with a 1/4" O.D. push connector for customer attachment.

Before installing your unit, prepare the water supply line. Please see plumbing requirements in the plumbing requirements table.

- Purge the water line prior to final connection to the unit. This removes any debris present in the line.
- Only connect to a potable water supply!
- Do not connect to a hot water supply!
- Install the water filter before turning on the water supply to the icemaker. See "Water Filter Installation" (page 18).
- A copper line is not recommended for this application.
- Check all water line fittings for leaks.
- Tape the supply line to the floor before moving the unit into its final installation location.
- In the water connection area (see the rough opening illustration), tape the water line to the floor.

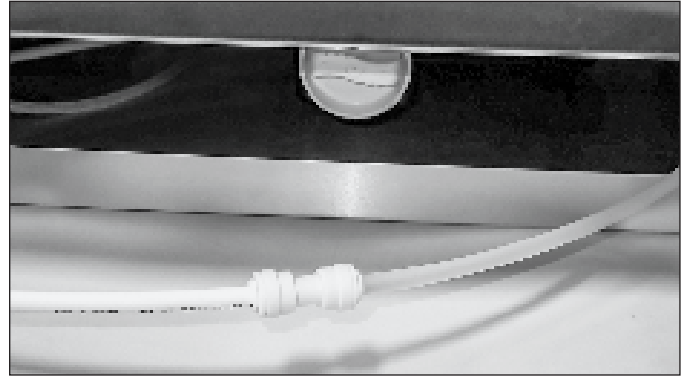
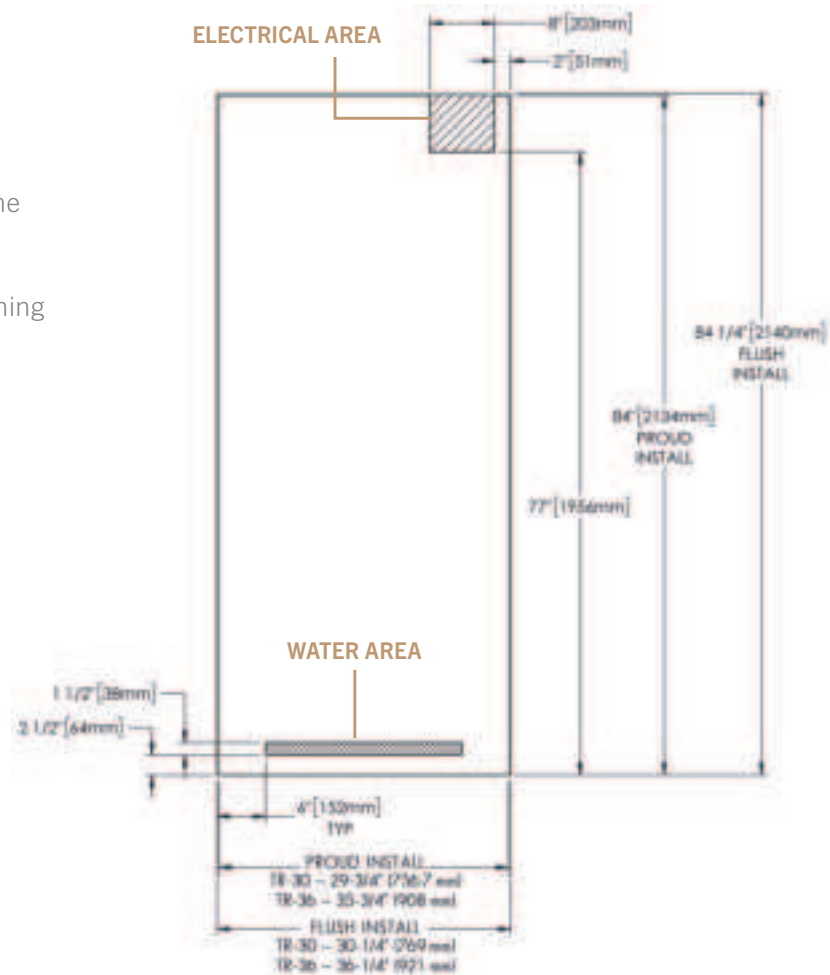

FIG. 1. Water line connection. Fitting included, PEX not included

Plumbing Requirements

Water Supply	1/4" PEX tubing (1/4" O.D. lines and fittings not included) NOTE: Copper line is not recommended
Flow Rate	0.5 gpm / 1.89 lpm
Operating Pressure	30-100 psi (207-689 kPa)
Incoming Water Temperature	33-100°F (0.6-38°C)



NOTE: DIMENSIONS MAY VARY BY ± 1/8" (3.175 mm)

WATER FILTER INSTALLATION & PERFORMANCE DATA

The water filter filters sediment and removes unpleasant taste and odor. Install the provided water filter before using the icemaker. The unit will not make ice until the water filter is installed.

PROCEDURE

1. Remove the kickplate. See fig. 1.
2. Insert the provided water filter (see fig. 2) and rotate the filter clockwise. (See figs. 3 and 4).
3. Reinstall the kickplate.

WATER FILTER PERFORMANCE DATA

- This system has been tested according to NSF/ANSI Standard 42, 53, 372, 401, P473 and CSA B483.1 for reduction of the substances listed below. The concentration of the indicated substances in water entering the system was reduced to a concentration less than or equal to the permissible limit for water leaving the system, as specified in NSF/ANSI Standards 42, 53, 372, 401, P473 and CSA B483.1.
- Systems certified for cyst reduction may be used on disinfected waters that may contain filterable cysts. The system conforms to NSF/ANSI 42, 53, 372, 401, P473 and CSA B483.1 for the specific performance claims as verified and substantiated by test data. Conforms to NSF/ANSI 53 for VOC reduction. See below for individual contaminants and reduction performance.

NOTE: TESTING WAS PERFORMED UNDER STANDARD LABORATORY CONDITIONS, ACTUAL PERFORMANCE MAY VARY.

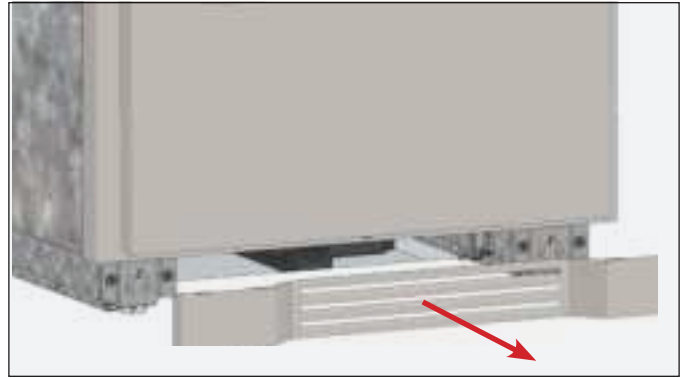

FIG. 1. Pull the kickplate from the cabinet.



FIG. 2. Locate the provided water filter shipped in the ice bucket.

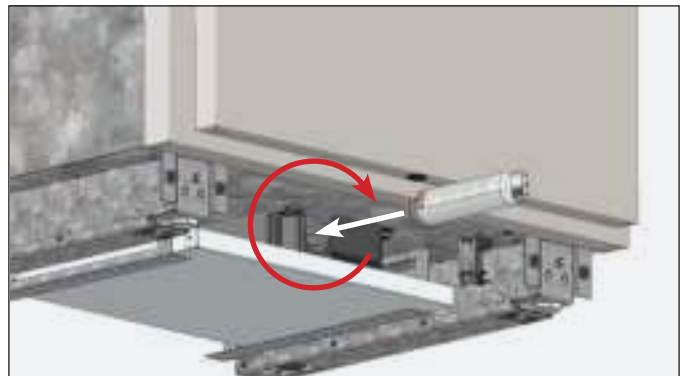

FIG. 3. Insert the water filter and rotate it clockwise.

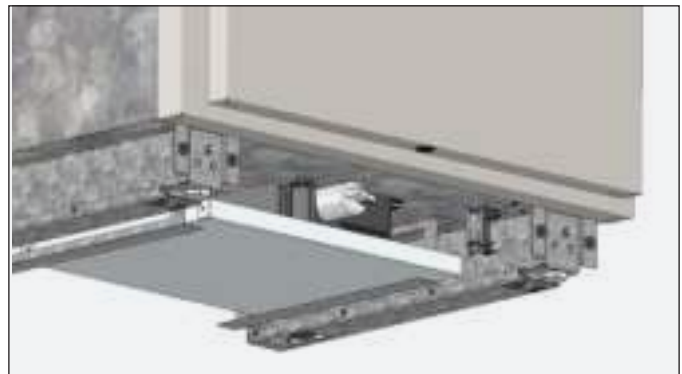

FIG. 4. Installed water filter.

INSTALLATION

WATER FILTER INSTALLATION & PERFORMANCE DATA (CONT.)

- System to be used with municipal or well water sources treated and tested on regular basis to ensure bacteriological safe quality. Do not use with water that is microbiologically unsafe or of unknown quality without adequate disinfection before or after the system.
- It is essential that the manufacturer's recommended installation, maintenance and filter replacement requirements be carried out for the product to perform as advertised. Manufactured by Aquamor, LLC, Temecula, CA.

Filter Specifications

Flow Rate	0.5 gpm / 1.89 lpm
Operating Temperature	33-100°F (0.6-38°C)
Operating Pressure	30-100 psi (kPa)
Capacity	300 gal. (1,136 L) or six months

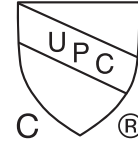

Contaminant and Reduction Performance

Contaminant	% of reduction	Influent Concentration	Max Allowable
CHLORINE	>97%	2.0 mg/L	1.0 mg/L
ALACHLOR*	>98%	0.050	0.001
Asbestos	99.98%	189 MFL	99%
ATRAZINE*	>97%	0.100	0.003
BENZENE*	>99%	0.081	0.001
BISPHENOL	99.1%	2.058 mg/L	<0.300ng/L
BROMODICHLOROMETHANE (TTHM)*	>99.8%	0.300	0.015
BROMOFORM (TTHM)*	>99.8%	0.300	0.015
CARBOFURAN (Furadan)*	>99%	0.19	0.001
Carbon Tetrachloride	>95%	0.014	0.005
CHLORDANE	>99.5%	0.04 +/-10%	0.002
CHLOROBENZENE (Monochlorobenzene)*	>99%	0.077	0.001
CHLOROPICRIN*	99%	0.015	0.0002
CHLOROFORM (TTHM)* (surrogate chemical)	>99.8%	0.300	0.015
2, 4-D*	98%	0.110	0.0017
CYST (Giardi; Cryptosporidium; Entamoeba; Toxoplasma)	>99.95%	MINIMUM 50,000/L	^{99.95% REDUCTION REQUIREMENT}
Cryptosporidium (see CYST)	>99.95%	MINIMUM 50,000/L	^{99.95% REDUCTION REQUIREMENT}
DBCP (see Dibromochloropropane)*	>99%	0.052	0.00002
1,2-DCA (see 1,2-DICHLOROETHANE)*	95%	0.088	0.0048
1,1-DCE (see 1,1-DICHLOROETHYLENE)*	>99%	0.083	0.001
DIBROMOCHLOROMETHANE (THM; Chlorodibromomethane)*	>99.8%	0.300	0.015
DIBROMOCHLOROPROPANE (DBCP)*	>99%	0.052	0.00002
o-DICHLOROETHYLENE (1,2-Dichlorobenzene)*	>99%	0.080	0.001
p-DICHLOROETHYLENE (para-Dichlorobenzene)	>98%	0.040	0.001
1,2-DICHLOROETHANE (1,2-DCA)*	95%	0.088	0.0048
1,1-DICHLOROETHYLENE (1,1-DCE)*	>99%	0.083	0.001
CIS-1,2-DICHLOROETHYLENE*	>99%	0.170	0.0005
TRANS-1,2-DICHLOROETHYLENE*	>99%	0.086	0.001
1,2-DICHLOROPROPANE (Propylene Dichloride)*	>99%	0.080	0.001
CIS-1,3-DICHLOROPROPYLENE*	>99%	0.079	0.001
DINOSEB*	99%	0.170	0.0002
EDB (see ETHYLENE DIBROMIDE)*	>99%	0.044	0.00002
ENDRIN	99%	0.053	0.00059
Entamoeba (see CYSTS)	99.95%	MINIMUM 50,000/L	^{99.95% REDUCTION REQUIREMENT}
ESTRONE	96.9%	0.1388 mg/L	<0.020 mg/L
ETHYLBENZENE*	>99%	0.088	0.001
ETHYLENE DIBROMIDE (EDB)*	>99%	0.044	0.00002
Furadan (see CARBOFURAN)*	>99%	0.19	0.001
Giardia Lambia (see CYST)	>99.95%	MINIMUM 50,000/L	^{99.95% REDUCTION REQUIREMENT}
HALOACETONITRILES (HAN)*			
BROMOCHLOROACETONITRILE	98%	0.022	0.0005
DIBROMOACETONITRILE	98%	0.024	0.0006
HALOACETONITRILES (HAN)*			
DICHLOROACETONITRILE	98%	0.0096	0.0002
TRICHLOROACETONITRILE	98%	0.015	0.0003

Contaminant	% of reduction	Influent Concentration	Max Allowable
HALOKETONES (HK):*			
1,1-DICHLORO-2-PROPANONE	99%	0.0072	0.0001
1,1,1-TRICHLORO-2-PROPANONE	96%	0.0082	0.0003
HEPTACHLOR*	>99%	0.25	0.00001
HEPTACHLOR EPOXIDE*	98%	0.0107	0.0002
HEXACHLOROBUTADIENE (Perchlorobutadiene)*	>98%	0.044	0.001
HEXACHLOROCYCLOPENTADIENE*	>99%	0.060	0.000002
IBUPROFEN	96.7%	0.432 mg/L	<0.060 mg/L
LEAD (pH 6.5)	>99.3%	0.15 +/- 10%	0.010
LEAD (pH 8.5)	>99.3%	0.15 +/- 10%	0.010
LINDANE*	>99%	0.055	0.00001
METHOXYCHLOR*	>99%	0.050	0.0001
Methylbenzene (see TOLUENE)*	>99%	0.078	0.001
Mercury (pH 6.5)	74.9%	0.0059	0.002
Mercury (pH 8.5)	97.8%	0.0061	0.002
Monochlorobenzene (see CHLOROBENZENE)*	>99%	0.077	0.001
NAPROXEN	95.3%	0.130 mg/L	<0.020 mg/L
NONYLPHENOL	97.1%	2.058 mg/L	<0.200 mg/L
POLYCHLORINATED BIPHENYLS (PCBs, Aroclor 1260)	>99.9%	0.01 +/- 10%	0.0005
PCE (see Tetrachloroethylene)	>96%	0.014	0.005
PENTACHLOROPHENOL*	>99%	0.096	0.001
Perchlorobutadiene (see HEXACHLOROBUTADIENE)*	>98%	0.044	0.001
PFOA	98.0%	0.0005 mg/L	<0.00007 mg/L
PFOS	98.0%	0.001 mg/L	<0.00007 mg/L
Phenytoin	94.7%	0.2173 mg/L	<.030 mg/L
Propylene Dichloride (see 1,2-DICHLOROPROPANE)*	>99%	0.080	0.001
SIMAZINE*	>97%	0.120	0.004
STYRENE (Vinylbenzene)*	>99%	0.150	0.0005
1,1,1-TCA (see 1,1,1-TRICHLOROETHANE)*	95%	0.084	0.0046
1,2,4-Trichlorobenze	>99%	0.215	0.07
TCE (see TRICHLOROETHYLENE)*	>99%	0.180	0.0010
1,1,2,2-TETRACHLOROETHANE*	>99%	0.081	0.001
TETRACHLOROETHYLENE*	>99%	0.081	0.001
TOLUENE (Methylbenzene)*	>99%	0.078	0.001
TOXAPHENE	>92.9%	0.015 +/- 10%	0.003
2,4,5-TP (Silvex)*	99%	0.270	0.0016
Toxoplasma (see CYST)	>99.95%	MINIMUM 50,000/L	^{99.95% REDUCTION REQUIREMENT}
TRIBROMOACETIC ACID*		0.042	0.001
1,1,1-TRICHLOROETHANE (1,1,1-TCA)*	95%	0.084	0.0046
1,1,2-TRICHLOROETHANE*	>99%	0.150	0.0005
TRICHLOROETHYLENE (TCE)*	>99%	0.180	0.0010
TRIHALOMETHANES (THM) (Chloroform; Bromoform; Dibromochloromethane; Dibromochloromethane)	>99.8%	0.300	0.015
Unsym-Trichlorobenzene (see 1,2,4-TRICHLOROETHANE)*	>99%	0.160	0.0005
Vinylbenzene (see STYRENE)*	>99%	0.150	0.0005
XYLENES (TOTAL)*	>99%	0.070	0.001

WIRE RACK HANDLE FINISH APPLICATION (TR-30DZW)

See finish (e.g., paint or stain) for application instructions and drying / curing times. Drying / Curing times vary by finish. Follow recommended guidelines associated with treating unfinished natural cherry wood.

NOTE: REMOVE THE WINE RACK HANDLES FROM THE WINE RACK ASSEMBLY BEFORE APPLYING FINISH!

NOTE: FINISH ODORS FROM PANELS INSTALLED BEFORE FULLY DRYING / CURING CAN LINGER AND BE ABSORBED BY THE CABINET'S INTERIOR. TRUE IS NOT RESPONSIBLE FOR LINGERING FINISH ODORS INSIDE THE UNIT.

REMOVAL

REQUIRED TOOLS

- Phillips Screwdriver or Bit Driver
- Drill (optional)

PROCEDURE

1. Pull the wine rack forward.
2. Push the slide release tabs as indicated by the release arrows (see fig. 1) and pull the wine rack forward.
3. Remove the wine rack handle from the wine rack assembly. See fig. 2.

INSTALLATION

REQUIRED TOOLS

- Phillips Screwdriver or Bit Driver
- Drill (optional)

PROCEDURE

1. Install the wine rack handle on the wine rack assembly. See fig. 2.
2. Position the wine rack on the slides and carefully push the wine rack towards the back of the unit.

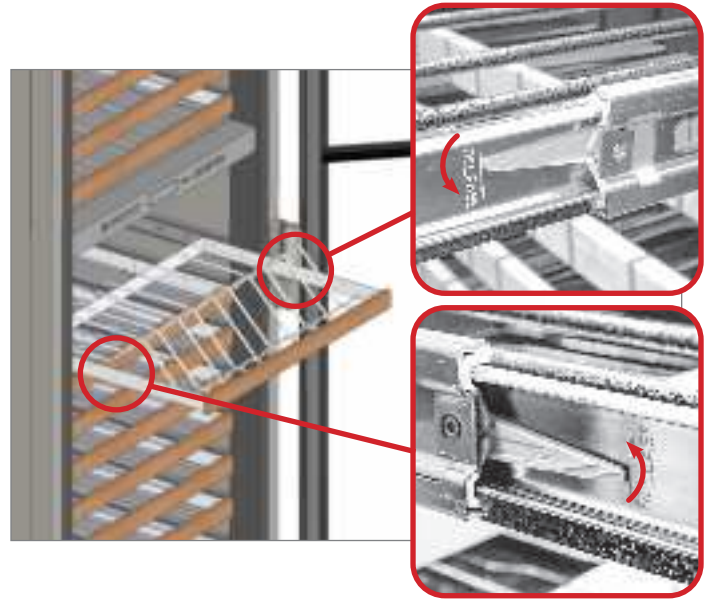

FIG. 1. Push the left release tab up and the right release tab down.

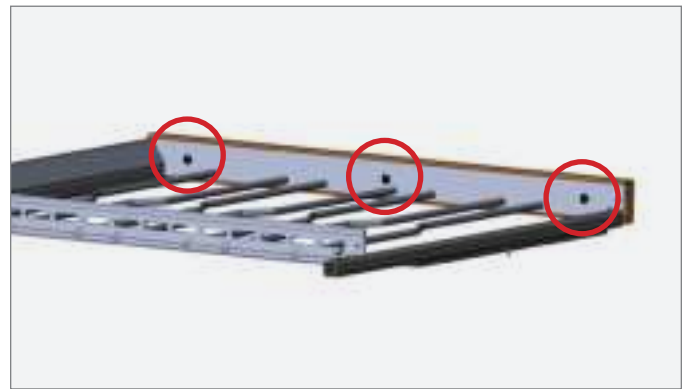

FIG. 2. Wine rack handle screw locations.

TR-30 / TR-42

TR-30 / TR-48

TR-30 / TR-30

TR-30 / TR-30 / TR-30

TR-36REF / TR-36REF

TR-36REF / TR-30REF



PRESERVE THE MOMENT®

INSTALLATION PLAN VIEWS

TR-30 / TR-42

TR-30 / TR-42 Rough Opening Dimensions		
	Flush Install	Proud Install
Width	72-1/4" (1835.15 mm)	71-3/4" (1822.45 mm)
Depth	25-25/32" (654.84 mm)	23-25/32" (604.04 mm)
Height	84-1/4" (2,139.95 mm)	84" (2,133.6 mm)

Dimensions may vary by $\pm 1/8"$ (3.2 mm)

NOTE: TR-36FRZ/30FRZ-IM-C MODELS WILL REQUIRE A WATER SUPPLY. SEE "OPTIONAL ICEMAKER" FOR ROUGH OPENING.

***WATER SUPPLY REQUIRED FOR TR-42FRZ/48FRZ-C MODELS OR LATER.**

FLUSH VS. PROUD INSTALL

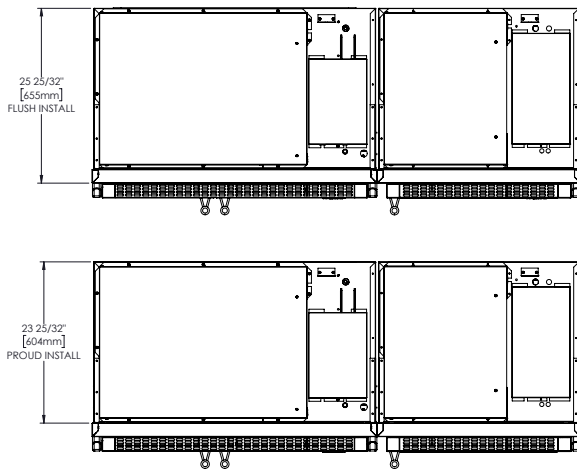

ROUGH OPENING & ELECTRICAL AREA

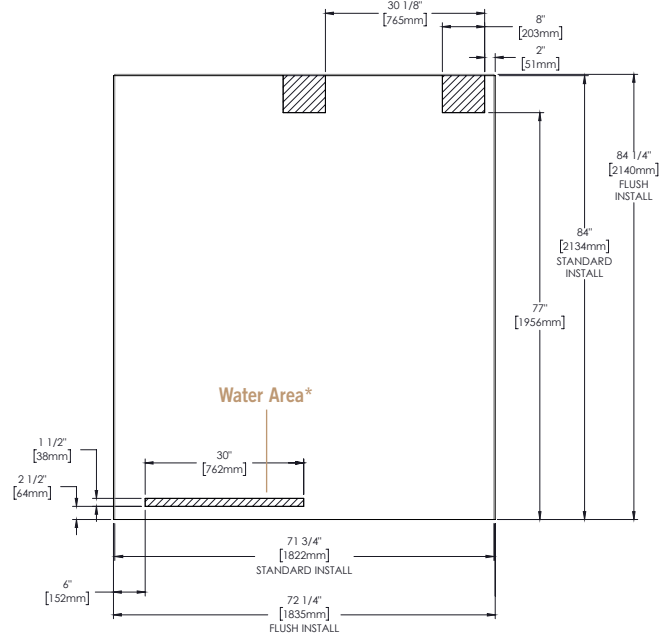

PLAN VIEW

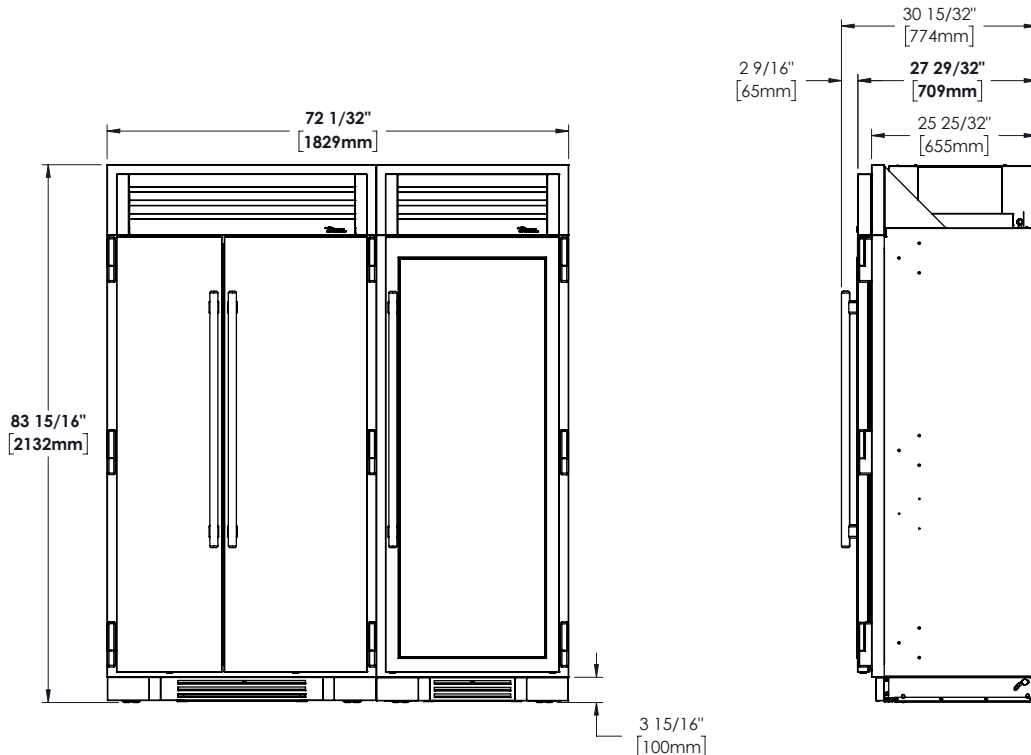

INSTALLATION PLAN VIEWS

TR-30 / TR-48

TR-30 / TR-48 Rough Opening Dimensions

	Flush Install	Proud Install
Width	78-1/4" (1987.55 mm)	77-3/4" (1974.85 mm)
Depth	25-25/32" (654.84 mm)	23-25/32" (604.04 mm)
Height	84-1/4" (2,139.95 mm)	84" (2,133.6 mm)

Dimensions may vary by $\pm 1/8"$ (3.2 mm)

NOTE: TR-36FRZ/30FRZ-IM-C MODELS WILL REQUIRE A WATER SUPPLY. SEE "OPTIONAL ICEMAKER" FOR ROUGH OPENING.

***WATER SUPPLY REQUIRED FOR TR-42FRZ/48FRZ-C MODELS OR LATER.**

FLUSH VS. PROUD INSTALL

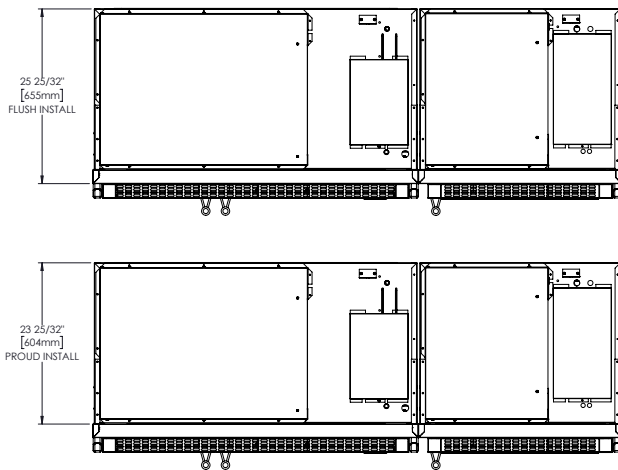

ROUGH OPENING & ELECTRICAL AREA

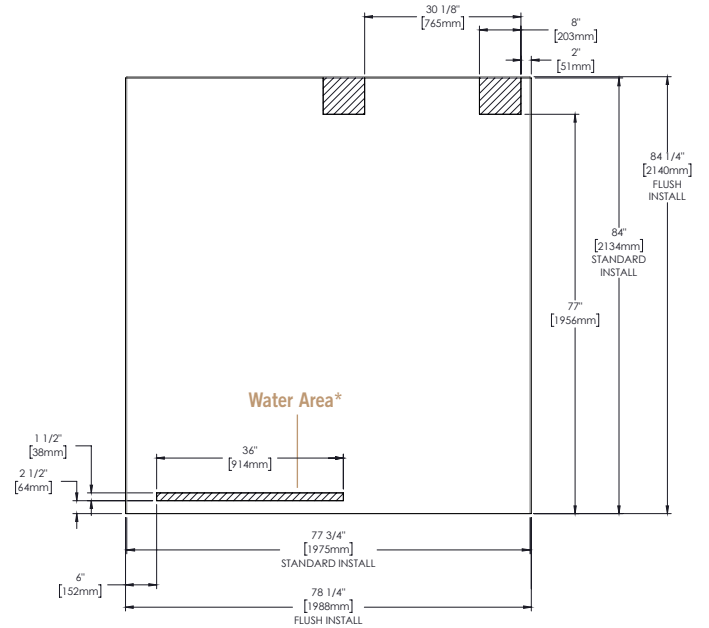

PLAN VIEW

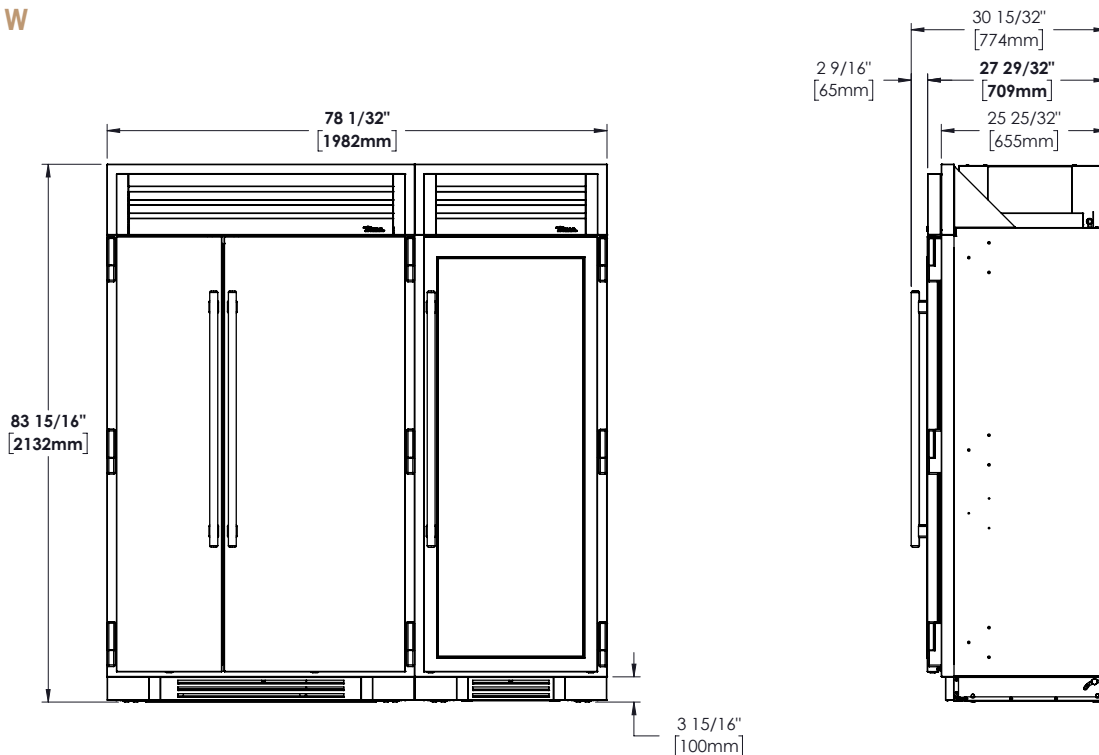

INSTALLATION PLAN VIEWS

TR-30 / TR-30

TR-30 / TR-30 Rough Opening Dimensions

	Flush Install	Proud Install
Width	60-1/4" (1530.35 mm)	59-3/4" (1517.65 mm)
Depth	25-25/32" (654.84 mm)	23-25/32" (604.04 mm)
Height	84-1/4" (2,139.95 mm)	84" (2,133.6 mm)

Dimensions may vary by $\pm 1/8"$ (3.2 mm)

NOTE: TR-36FRZ/30FRZ-IM-C MODELS WILL REQUIRE A WATER SUPPLY. SEE "OPTIONAL ICEMAKER" FOR ROUGH OPENING.

FLUSH VS. PROUD INSTALL

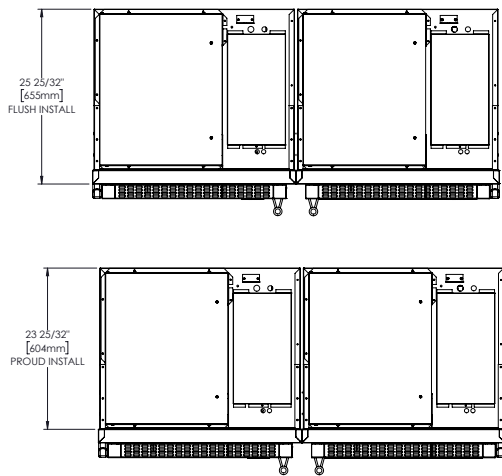

ROUGH OPENING & ELECTRICAL AREA

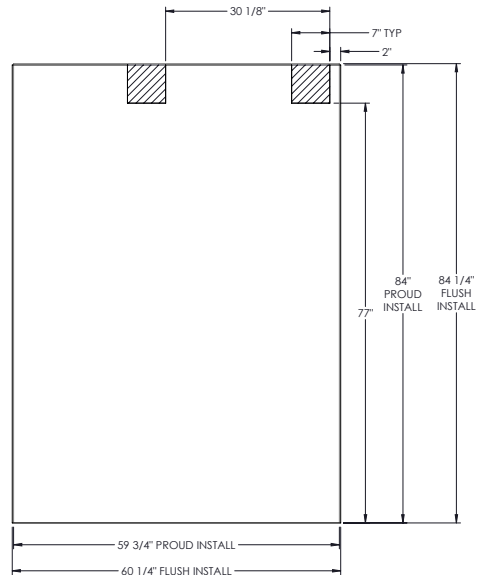

PLAN VIEW

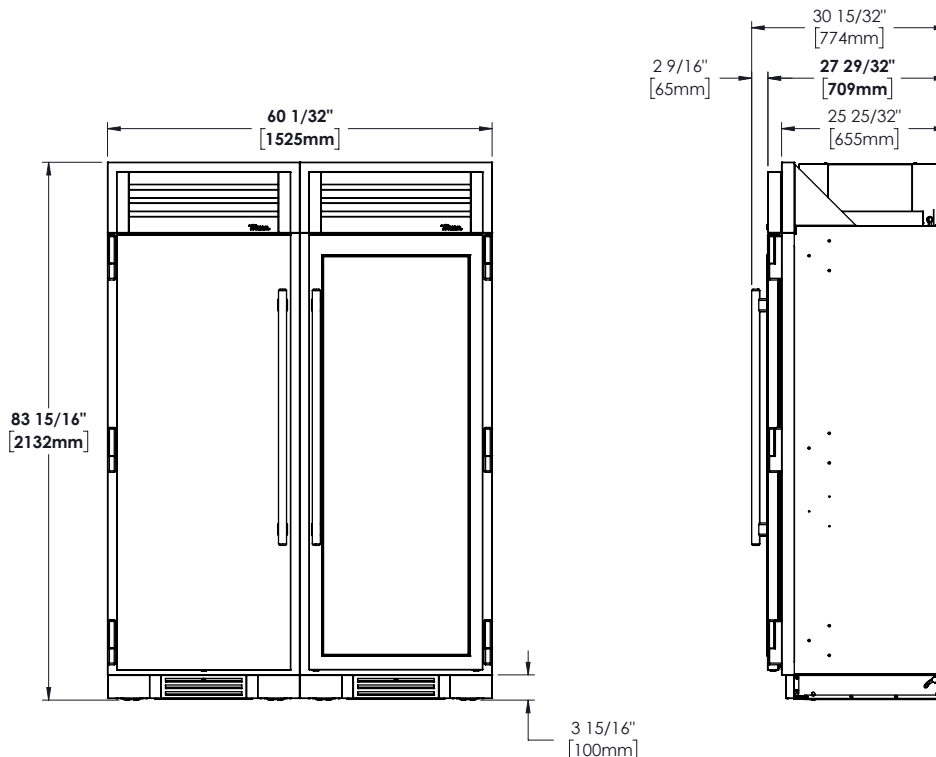

INSTALLATION PLAN VIEWS

TR-30 / TR-30 / TR-30

TR-30 / TR-30 / TR-30 Rough Opening Dimensions

	Flush Install	Proud Install
Width	90-1/4" (2292.35 mm)	89-3/4" (2279.65 mm)
Depth	25-25/32" (654.84 mm)	23-25/32" (604.04 mm)
Height	84-1/4" (2,139.95 mm)	84" (2,133.6 mm)

Dimensions may vary by $\pm 1/8"$ (3.2 mm)

NOTE: TR-36FRZ/30FRZ-IM-C MODELS WILL REQUIRE A WATER SUPPLY. SEE "OPTIONAL ICEMAKER" FOR ROUGH OPENING.

FLUSH VS. PROUD INSTALL

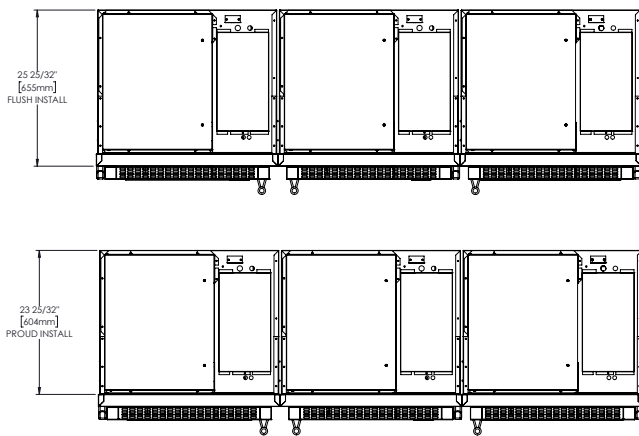

ROUGH OPENING & ELECTRICAL AREA

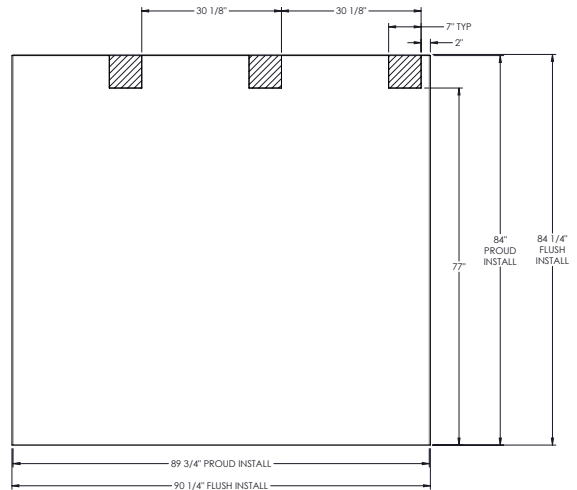

PLAN VIEW

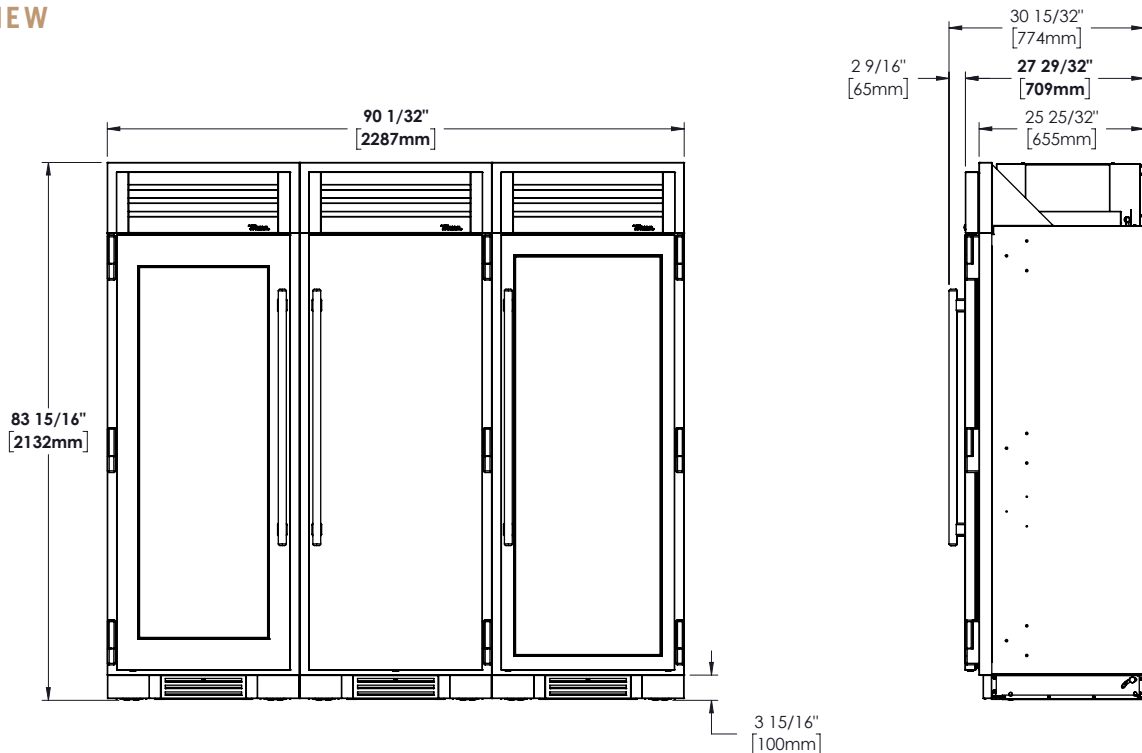

INSTALLATION PLAN VIEWS

TR-36REF / TR-36REF

TR-36 / TR-36 Rough Opening Dimensions		
	Flush Install	Proud Install
Width	72-1/4" (1835.15 mm)	71-3/4" (1822.45 mm)
Depth	25-25/32" (654.84 mm)	23-25/32" (604.04 mm)
Height	84-1/4" (2,139.95 mm)	84" (2,133.6 mm)

Dimensions may vary by $\pm 1/8"$ (3.2 mm)

NOTE: TR-36FRZ/30FRZ-IM-C MODELS WILL REQUIRE A WATER SUPPLY. SEE "OPTIONAL ICEMAKER" FOR ROUGH OPENING.

FLUSH VS. PROUD INSTALL

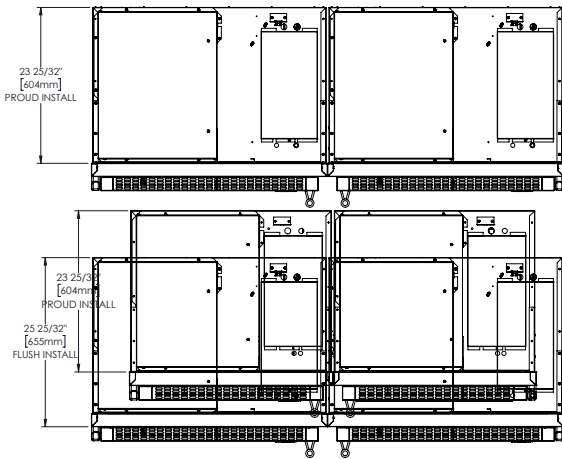

ROUGH OPENING & ELECTRICAL AREA

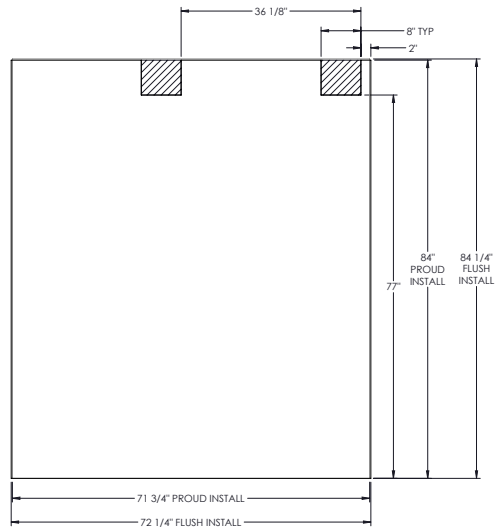

PLAN VIEW

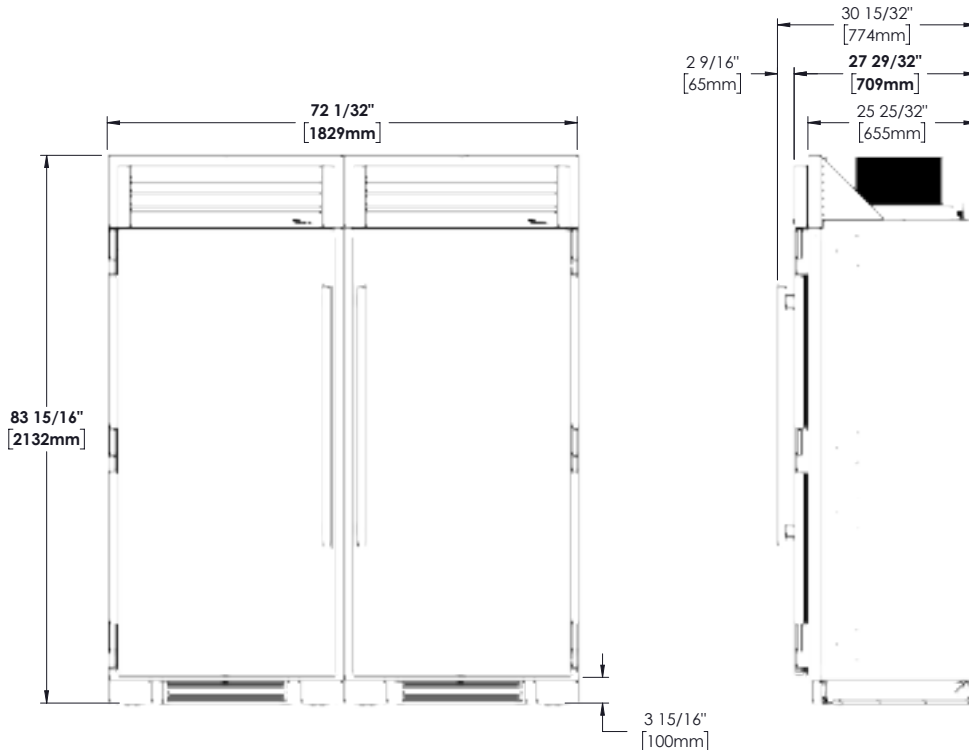

INSTALLATION PLAN VIEWS

TR-36REF / TR-30REF

TR-36 / TR-30 Rough Opening Dimensions		
	Flush Install	Proud Install
Width	66-1/4" (1682.75 mm)	65-3/4" (1670.055 mm)
Depth	25-25/32" (654.84 mm)	23-25/32" (604.04 mm)
Height	84-1/4" (2,139.95 mm)	84" (2,133.6 mm)

Dimensions may vary by $\pm 1/8"$ (3.2 mm)

NOTE: TR-36FRZ/30FRZ-IM-C MODELS WILL REQUIRE A WATER SUPPLY. SEE "OPTIONAL ICEMAKER" FOR ROUGH OPENING.

FLUSH VS. PROUD INSTALL

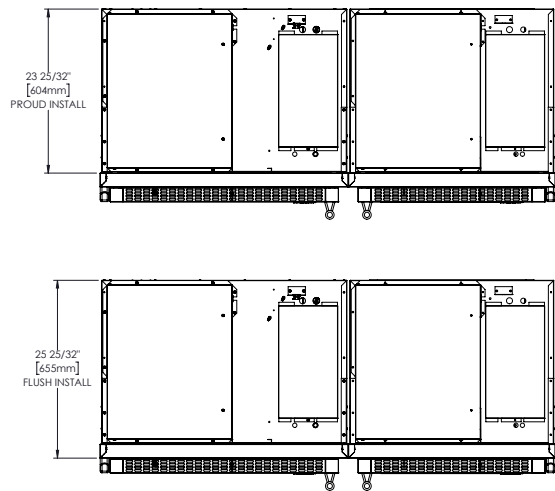

ROUGH OPENING & ELECTRICAL AREA

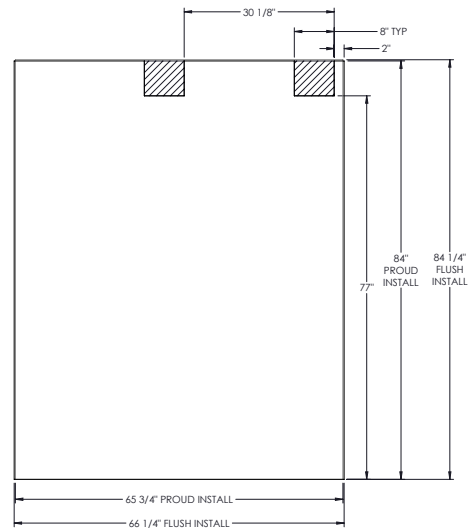

PLAN VIEW

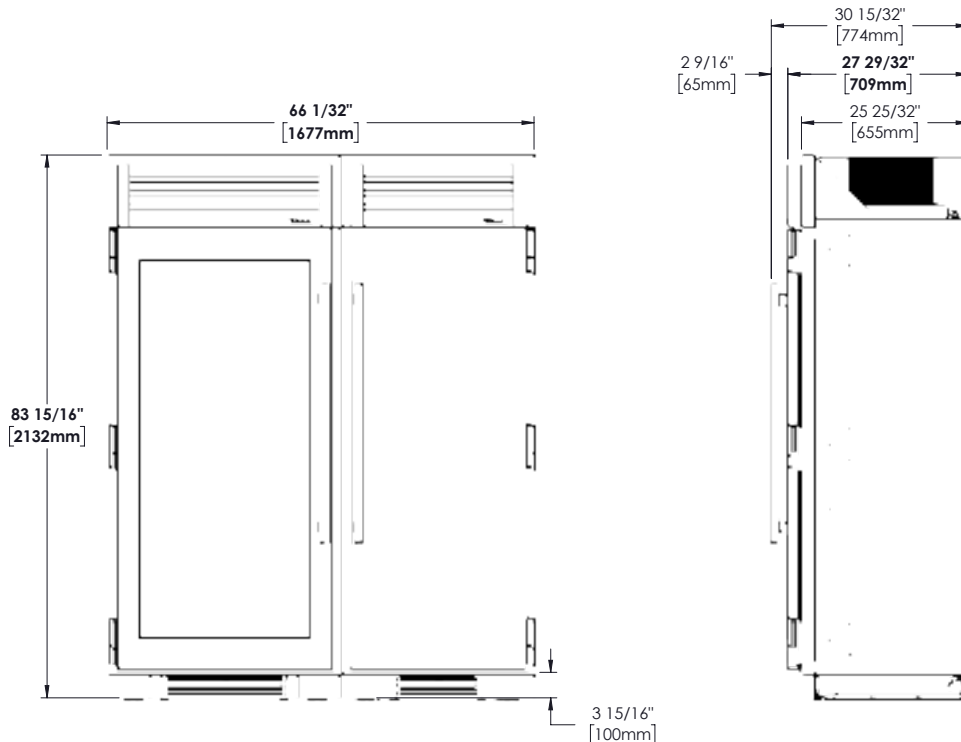

UNCRATING

ANTI-TIP BRACKET INSTALLATION

LEVELING

KICKPLATE INSTALLATION

JOINING KIT INSTALLATION



PRESERVE THE MOMENT®

UNCRATING

REQUIRED TOOLS

- Drill or ratchet
- 7/16" Deep well socket
- Cutting Tool



WARNING! TIP OVER HAZARD. Unit poses a tipping hazard when moving or during installation. Do not move the unit without the shipping brackets installed.

Do not remove the appliance from the pallet without assistance. Failure to do so may result in property damage, personal injury, or death.

NOTE: YOUR APPLIANCE MAY NOT EXACTLY MATCH FIGURES SHOWN.

PROCEDURE

1. Inspect the pallet exterior packaging for visible damage. See fig. 1. Follow TRUE's recommended procedure for accepting deliveries.
2. Remove the exterior packaging. Inspect the unit's exterior for visible or cosmetic damage. See figs. 2 and 3

NOTE: DO NOT DISCARD THE KICKPLATE (SEE FIG. 4) IF MOVING THE UNIT A LONG DISTANCE (E.G., BETWEEN BUILDINGS OR ON STAIRS), DO NOT DISCARD THE EXTERIOR CARDBOARD.



FIG. 1. Inspect the exterior packaging for visible damage.



FIG. 2. Inspect the unit's exterior for visible damage.



FIG. 3. Be sure to inspect behind the rainshield.

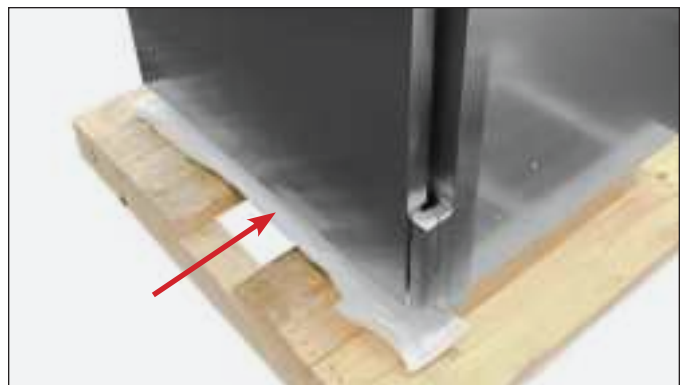

FIG. 4. Packaged kickplate ships tucked under the unit's front.

UNCRATING (CONT.)

3. Closely inspect the unit's interior for damage (e.g., scratches by shelving or damage to the door seal). See fig. 5.

NOTE: DO NOT REMOVE THE INTERIOR PACKAGING.

4. Move the unit as close as possible to the final installation location.

NOTE: SECURE THE DOOR BEFORE MOVING THE UNIT TO ITS FINAL LOCATION (SEE FIG. 6). REPACKAGE THE UNIT WITH THE EXTERIOR PACKAGING AS NEEDED BEFORE MOVING THE UNIT.

5. Unbolt the shipping bracket from the castor housing. Then, remove the anti-tip bracket. See figs. 7 and 8.

NOTE: DO NOT DISCARD THE ANTI-TIP BRACKET.



FIG. 5. Inspect inside the unit for visible damage. Do not remove the interior packaging.



FIG. 6. Always secure the door closed before moving the appliance.



FIG. 7. Shipping bracket bolt locations.



FIG. 8. Anti-tip bracket shipping bolt locations. Other side not shown.

UNCRATING (CONT.)

6. Remove the condensate drain pan. Set the drain pan aside. See fig. 9.
7. Slightly raise the rear leveling leg rollers. Turn the front adjustment screw 1/4-1/2 turn clockwise. See fig. 10.
8. With assistance, pull the unit off the back of the pallet. Then, remove the pallet and Carefully guide the unit to a fully upright position. See fig. 11.



CAUTION! Only lift with appliance moving equipment from the unit's sides, never the front or rear. See fig. 12. Failure to do so may result in personal injury or appliance damage. Do not lift the unit by handles, doors, or hinges.



FIG. 9. Remove the drain pan before pulling the appliance off the skid.

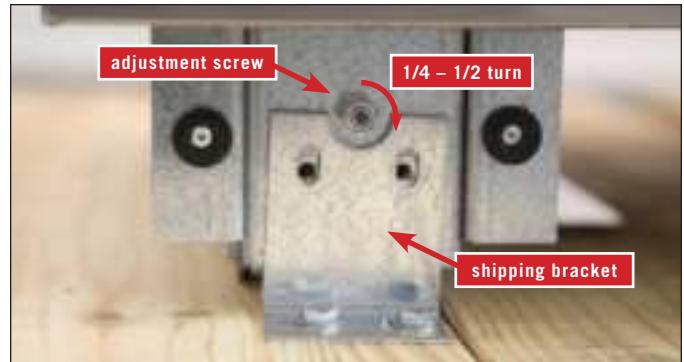

FIG. 10. Adjustment screw location. Other adjustment screw not shown.



FIG. 11a. With assistance, carefully walk the appliance partially off the back of the skid.



FIG. 11b. Then, tilt the unit backward and remove the skid.



FIG. 11c. Carefully guide the appliance to an upright position.

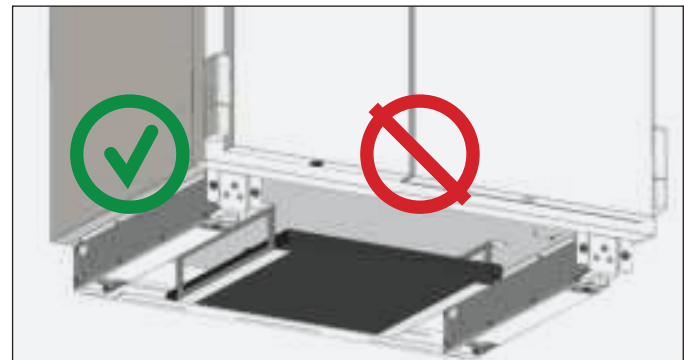

FIG. 12. Only lift with appliance moving equipment from the **SIDES**, **NEVER** the **FRONT** or **REAR**.

ANTI-TIP BRACKET INSTALLATION

KIT CONTENTS

- One (1) anti-tip bracket
- Four (4) 3/16" masonry screws
- Eight (8) #12 -2" wood screws
- Twelve (12) 1/4" washers

REQUIRED TOOLS

- Tape measure
- 7/16" socket
- Marking utensil
- Phillips bit driver
- 1/8" drill bit
- Drill or ratchet



WARNING! TIP OVER HAZARD. To avoid a hazard from appliance instability, install the anti-tip bracket in accordance with the instructions below.

BEFORE YOU BEGIN

Consult a flooring expert to confirm that the flooring where the unit will be installed is rated for at least 150 pounds per square foot.

PROCEDURE

1. Measure and mark the depth of the bracket's placement in the installation location.
 - For a flush installation: 24-31/32" (634.20625 mm)
 - For a proud installation: 22-31/32" (583.40625 mm)
2. Place and center the bracket at the measured depth.
3. With the bracket as a guide, drill pilot holes into the wall and/or floor.

NOTE: FOR INCREASED STABILITY, SECURE THE BRACKET TO AS MANY JOISTS AND/OR STUDS AS POSSIBLE.
4. With the provided hardware, secure the anti-tip bracket.
5. Adjust the rear leveling rollers 1/4 turn clockwise.
6. Slide the unit into place and hook the anti-tip bracket into the castor assembly slots.

30 INCH / 36 INCH UNIT

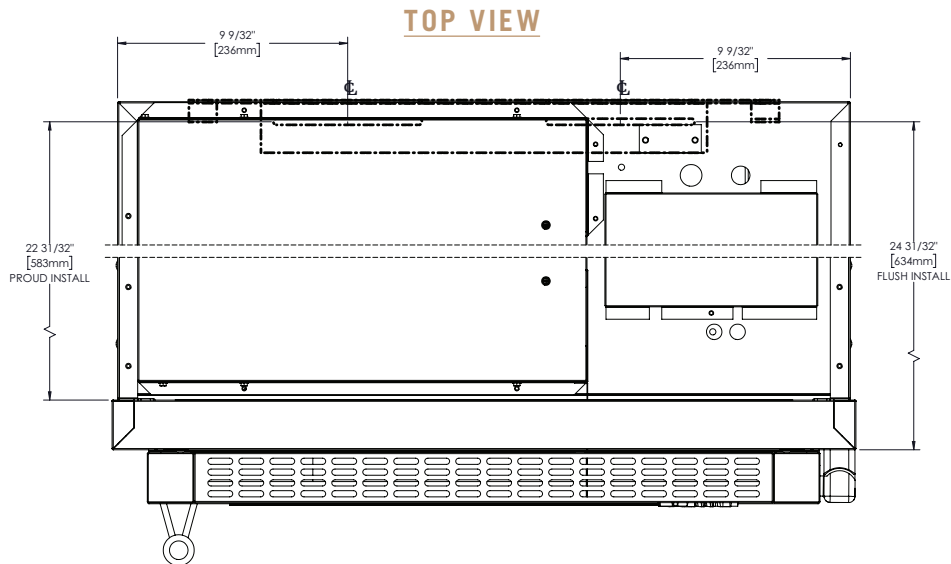

Dimensions may vary by $\pm 1/8"$ (3.2 mm)

LEVELING

It is important that your unit is level. This ensures the doors align and seal correctly and drain pans do not spill over.

PROCEDURE

1. Place a level on the interior floor on the unit. Check the level back-to-front and side-to-side. See fig. 1 for leveling adjustment locations.
2. Adjust the front leveling legs as needed with pliers or an adjustable wrench.
3. Adjust the rear leveling legs as needed with a 7/16" socket. Turn clockwise to raise the rear of the unit.

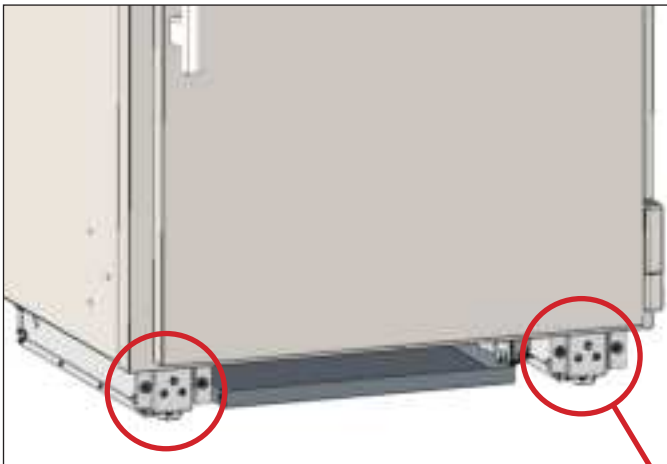
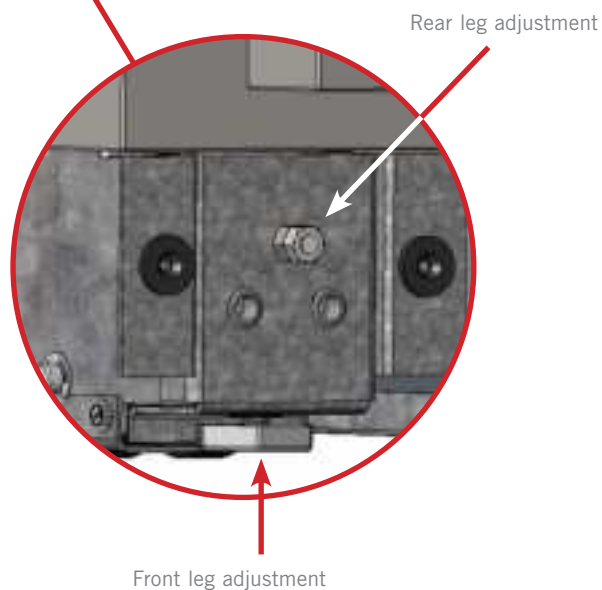

FIG. 1. Leveling leg adjustment locations.



KICKPLATE INSTALLATION

The kickplate (see fig. 1) is shipped unattached to the unit to allow easy access for leveling the unit. The kickplate attaches to the unit with magnets (see fig. 2) located on either side at the bottom of the unit.

INSTALLATION

After leveling the unit, position the kickplate at the bottom of the unit's front. See fig. 3.

REMOVAL

Pull the kickplate away from the unit.

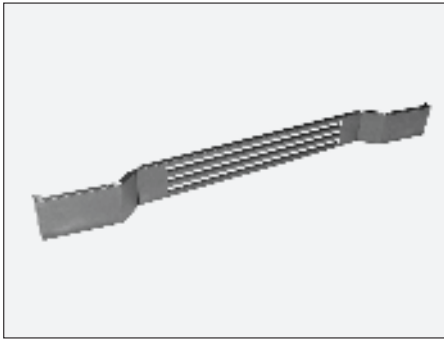

FIG. 1. The kickplate.

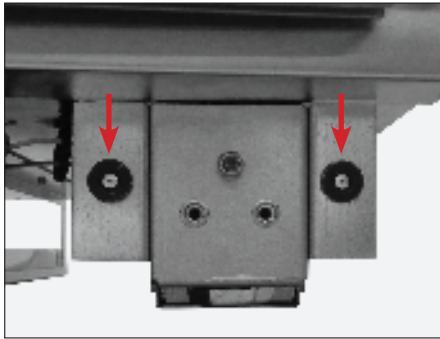

FIG. 2. The magnets. One side shown.

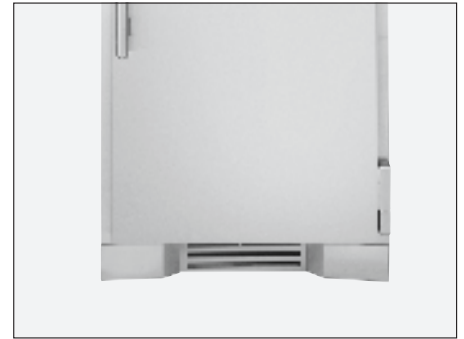

FIG. 3. Installed kickplate.

JOINING KIT INSTALLATION

Kit Sizes: 60" (1524 mm) / 72" (1828.8 mm) / 78" (1981.2 mm) / 90" (2286 mm)

KIT CONTENTS

- (1) Joining Rainshield Assembly
- (1) Joining Kickplate
- Anti-Sweat Foam End Panels*
- Joining Bracket*
- 1/4-20 x 1" Hex Head Screws*
- 1/4" Split Lock Washers*

*Quantities vary by kit size.

REQUIRED TOOLS

Required tools include (but may not be limited to) the following:

- Phillips Bit Driver or Screwdriver
- 7/16" Socket Wrench
- 1/4" Socket Wrench
- Tape
- Marking Utensil
- Drill

NOTE: MAKE SURE THE ANTI-TIP BRACKETS ARE INSTALLED PER INSTALLATION MANUAL INSTRUCTIONS. EACH UNIT WILL ALSO NEED TO BE PROPERLY LEVELED PER INSTALLATION MANUAL INSTRUCTIONS.



CAUTION! Electrical shock or burn hazard. Unplug the unit or turn off the power supply before proceeding.



WARNING! To avoid hazards from appliance instability, be sure to install the anti-tip brackets (see fig. 1) on each individual unit per the installation manual instructions.



WARNING! TIP OVER HAZARD. A child or adult could tip the appliance, resulting in property damage or bodily harm. Follow these instructions to properly install the anti-tip device. If the appliance is moved, verify that the device is properly engaged before the normal usage of the appliance commences.



FIG. 1. Anti-tip bracket. Be sure to install a bracket for each unit.



FIG. 2. Pull the rainshield open.



FIG. 3. Locate the reed switch in the bottom of the rainshield.



FIG. 4. Remove the plastic cover.

JOINING KIT INSTALLATION (CONT.)

Kit Sizes: 60" (1524 mm) / 72" (1828.8 mm) / 78" (1981.2 mm) / 90" (2286 mm)

PROCEDURE

1. Remove the reed switch bracket. See figs. 2 and 3.
2. Remove the reed switch cover, and then disconnect the reed switch. See figs. 4 and 5.



NOTE: IF FOUR (4) WIRES ARE CONNECTED TO THE REED SWITCH, BE SURE TO CLEARLY LABEL THE WIRES' ORIGINAL LOCATIONS BEFORE DISCONNECTING THE REED SWITCH. WIRE LOCATION IS CRITICAL TO THE CABINET'S OPERATION. SEE FIG. 5.

3. Remove the reed switch wire from the rainshield. See figs. 6 and 7.
4. Remove the rainshield. See figs. 8-10.
5. Repeat steps 1-4 for each unit of the joined installation.
6. Remove the inner magnet brackets (see figs. 11 and 12). Then, thread and tighten the magnet bracket screws. Discard the magnet bracket.

NOTE: BE SURE TO RETURN MAGNET BRACKET SCREWS TO THEIR ORIGINAL POSITIONS; THE SCREWS SUPPORT THE CASTOR ASSEMBLY HOUSING.

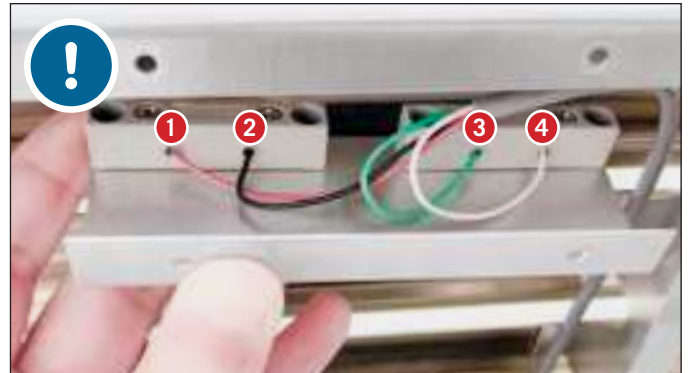

FIG. 5. Label the original wire locations **BEFORE** disconnecting the reed switch.



FIG. 6. Remove the p-clip holding the wire to the rainshield.



FIG. 7. Pull the reed switch wire through the rainshield bushing.



FIG. 8. Bracket screw location. Other bracket not shown.



FIG. 9. Rainshield screw locations.



FIG. 10. Remove the screws from the metal channel.

JOINING KIT INSTALLATION (CONT.)

Kit Sizes: 60" (1524 mm) / 72" (1828.8 mm) / 78" (1981.2 mm) / 90" (2286 mm)

7. Install anti-sweat foam end panels on the joined units' sides where the cabinets will meet. See figs. 13 and 14.
8. Position the units in front of the final installation location. Then, level the units.
9. Verify the fronts of the units are flush at the seams and the gap(s) between the units is (are) consistent from top to bottom. See figs. 15 and 16.
10. With the provided hardware, install the joining bracket across the interior legs. See figs. 17 and 18.
11. With the existing hardware, install the joining rainshield assembly. See fig. 19.

NOTE: ASSISTANCE (AT LEAST TWO (2) PEOPLE) RECOMMENDED.

12. Route the reed switch wires through the rainshield. See figs. 6 and 7.
13. With the predrilled holes in the joining rainshield, connect and install the reed switches near the handle-side of the units.

NOTE: BE SURE TO CONNECT THE WIRES TO THE REED SWITCH AS ORIGINALLY CONFIGURED. WIRE LOCATION IS CRITICAL TO THE CABINET'S OPERATION. SEE FIGS. 5 OR 20.



FIG. 11. Remove and discard the interior magnet brackets.



FIG. 12. Magnet bracket screw locations.



FIG. 13. Install the anti-sweat foam panel where the unit will be positioned next to another unit.

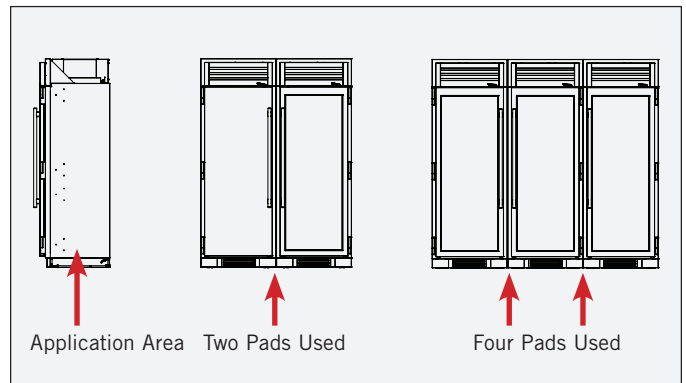

FIG. 14. Install foam pads between the joined units.

JOINING KIT INSTALLATION (CONT.)

Kit Sizes: 60" (1524 mm) / 72" (1828.8 mm) / 78" (1981.2 mm) / 90" (2286 mm)

14. Walk the joined units into their final installation location.
15. Verify the level of the cabinets. Level the units as needed.
16. Restore power to the units and turn the units on.
17. After 3 minutes of runtime, open the doors individually and verify correct door switch operation. When operating correctly, the following should occur:
 - Unless set otherwise, the lights turn on and off with the door openings.
 - The evaporator (interior) fan turns on and off with door openings.
 - There is a low-pitched click from the control board area when the door opens or shuts.
18. Install the joining kit grill.

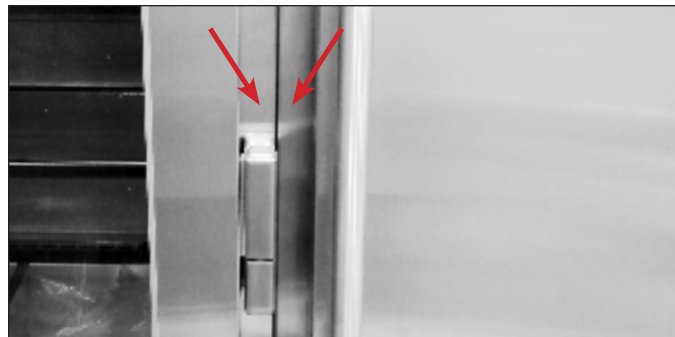

FIG. 15. Verify the cabinet fronts are flush. Adjust the units accordingly.

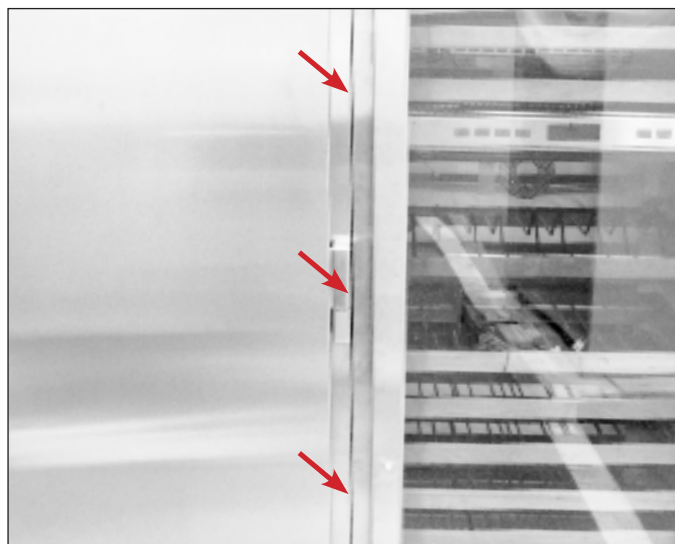

FIG. 16. Verify the gap(s) between cabinets is (are) even throughout.

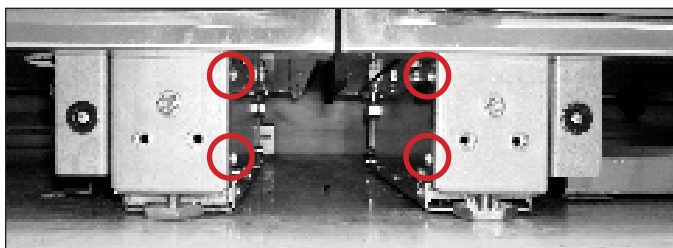

FIG. 17. Return the magnet bracket screws to their original locations



FIG. 18. Installed joining bracket.

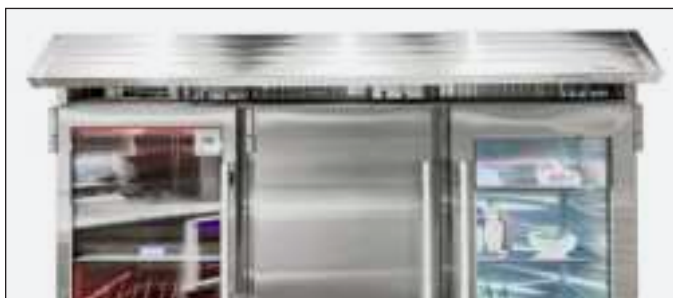

FIG. 19. Installed joining rainshield.

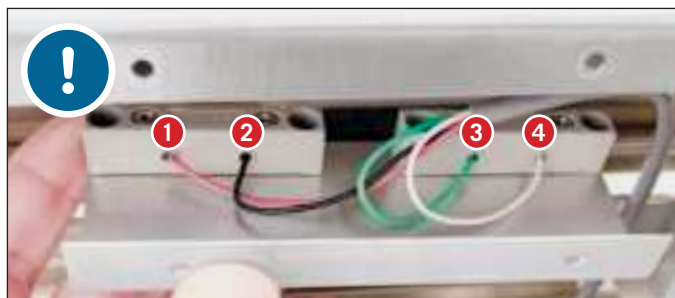

FIG. 20. Connect the reed switches with the original wire configurations.

SHELVING, BINS, DRAWERS

REFRIGERATOR STORAGE

DOOR BINS

DRAWERS

FREEZER STORAGE

WIRE BASKET

OPTIONAL ICEMAKER



PRESERVE THE MOMENT®

SHELVING, BINS, DRAWERS

Your TRUE appliance ships with shelving and drawers installed. Door bins ship packaged inside the unit. See fig. 1.

REFRIGERATOR STORAGE

GLASS SHELVES

Remove interior packaging before use. See fig. 2.

ADJUSTMENT

1. Tilt the shelf front forward. See fig. 3.
2. Lift the shelf up and out of the unit.
3. Hook the shelf into the desired shelf standard slots. See fig. 4.



FIG. 1. Interior packaging.



FIG. 2. Remove interior packaging from shelving.



FIG. 3. Hook the shelves into the shelf standards.



FIG. 4. Installed shelving.

DOOR BINS

Door bins ship in the refrigerator's bottom drawer. See fig. 5.

INSTALLATION

1. Hook a door bin into the door slots. See fig. 6.
2. Push the bin down to ensure the tabs are fully engaged in the slots. See fig. 7.

CAUTION! INCORRECTLY INSTALLED DOOR BINS MAY RESULT IN APPLIANCE DAMAGE OR PERSONAL INJURY.

REMOVAL

Lift the door bin up and away from the door.



FIG. 5. Packaged door bins.

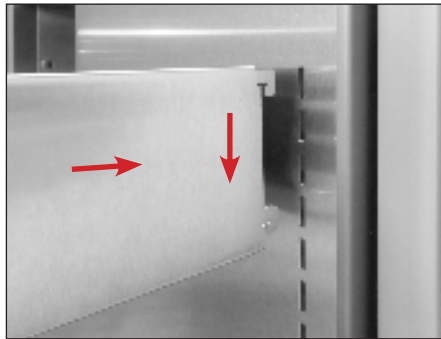

FIG. 6. Hook the door bins into the door slots.



FIG. 7. Final door bin installation.

DRAWERS

REMOVAL

1. Pull the drawer fully forward.
2. Remove the drawer slide screws. See fig. 8.
3. Lift the drawer from the unit.

REMOVAL

1. Pull the drawer slides fully forward.
2. Position the drawer on the drawer slides and carefully push the drawer towards the back of the unit. Lift the drawer from the unit.

NOTE: BE SURE THE DRAWER SITS UNDER THE SLIDES' REAR TABS. SEE FIG. 9.

3. Reinstall the drawer slide screws.

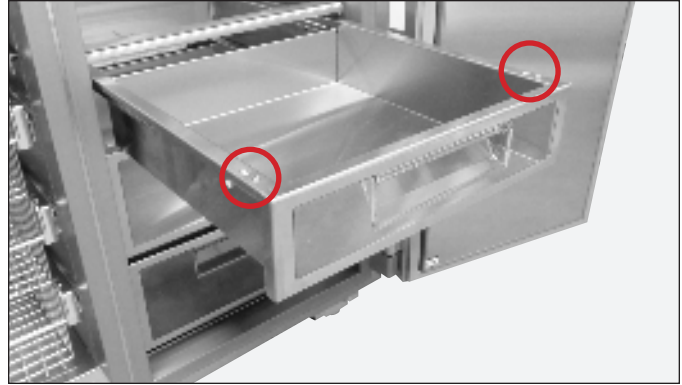

FIG. 8. Drawer slide screw locations.

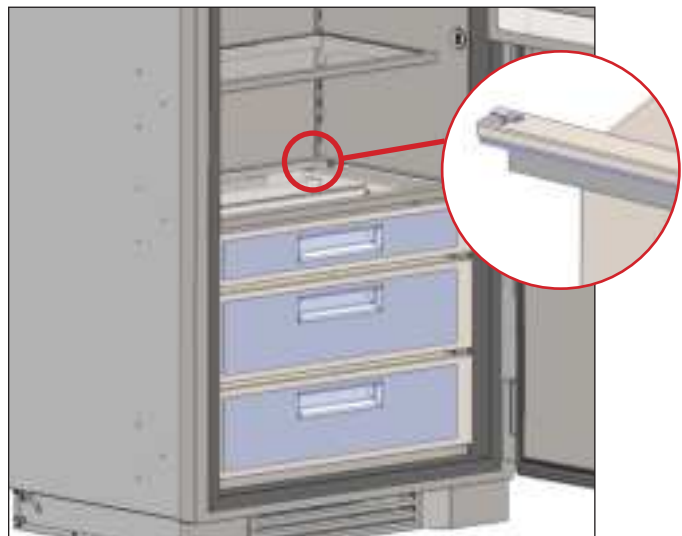

FIG. 9. Be sure the drawer sits under the rear tabs.

FREEZER STORAGE

WIRE SHELVES

Your True appliance ships with shelving installed. Remove interior packaging before use. See fig. 10.

ADJUSTMENT

1. Tilt the shelf front forward. See fig. 11.
2. Lift the shelf up and out of the unit.
3. Hook the shelf into the desired shelf standard slots. See fig. 12.



FIG. 10. Interior packaging.



FIG. 11. Hook the shelves into the shelf standards.



FIG. 12. Installed shelving.

WIRE BASKETS

REMOVAL

1. Pull the drawer fully forward.
2. Remove the drawer slide screws. See fig. 13.
3. Lift the drawer from the unit.

INSTALLATION

1. Pull the drawer slides fully forward.
2. Position the drawer on the drawer slides and carefully push the drawer towards the back of the unit. NOTE: Be sure the drawer sits under the slides' rear tabs. See fig. 14.
3. Reinstall the drawer slide screws.

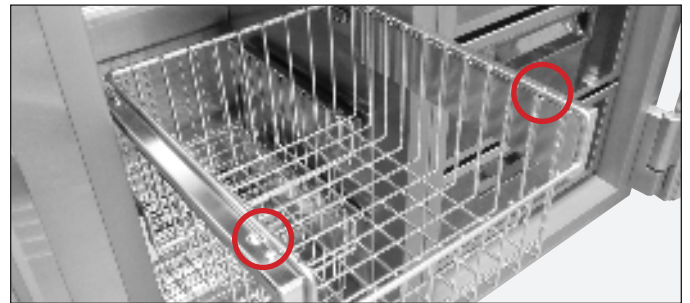

FIG. 13. Drawer slide screw locations.



FIG. 14. Drawer slide screw locations.

OPTIONAL ICEMAKER

The icemaker (see fig. 1) is in the rear upper left of the freezer section. For water supply requirements, please see “Water Supply Requirements” (page 17). To turn the icemaker on, please see “Ice Menu Navigation” (page 55).

- The icemaker will not operate if the water filter has not been installed. See “Water Filter Installation” (page 18) for installation instructions.
- After the initial startup, **discard the first batch of produced ice**. This ice may contain impurities from new plumbing connections.
- Do not remove the ice bin, even if the icemaker is not in use. The ice bin prevents stacked product from damaging the icemaker.
- If ice is not used regularly, it may fuse together. To avoid this, discard the ice and allow the ice maker to replenish.

ICE SCOOP

The ice scoop ships inside the ice bin. See fig. 2.

MAX ICE

When the max ice is turned on, the unit maximizes ice production for 24 hours. For information on turning Max Ice on or off, please see “Ice Menu Navigation” (page 55).



FIG. 1. The icemaker.



FIG. 2. The ice scoop ships inside the ice bin.

TURN ON/OFF

TEMPERATURE ADJUSTMENT

MODE NAVIGATION

SHOWROOM MODE

ACCENT LIGHTING SYSTEM

ALARM NAVIGATION

NOTIFICATION ALERTS

ICE MENU NAVIGATION (OPTIONAL ICEMAKER ONLY)



PRESERVE THE MOMENT®

TURN ON/OFF

All units are shipped in **ON** mode. During the initial startup, the unit runs a short power up diagnostic followed by a single audible beep. The lights turn on and temperature readings appear on the display.





WARNING! Electrical shock or burn hazard. Turning the unit off with the power button does not remove the power supply from the control. Unplug the unit or turn off the power supply.

PLEASE NOTE THAT THOUGH THE DISPLAY CAN SHOW EITHER FAHRENHEIT OR CELSIUS, IN MOST CASES THE FIGURES SHOW FAHRENHEIT.

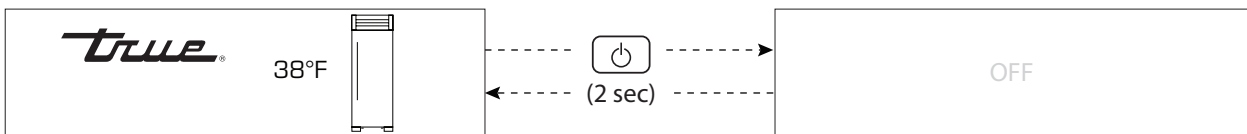
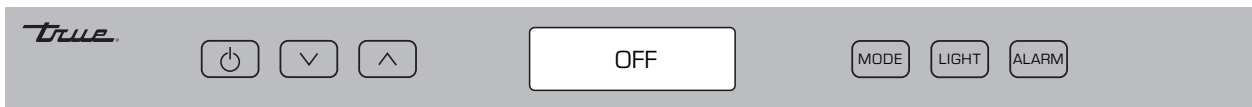
HOME SCREEN ON / OFF



TEMPERATURE ADJUSTMENT

1. Press down  or up  until the display shows the desired set point.

NOTE: A BUTTON PRESS CHANGES THE SET POINT BY 1° AND IS ACCOMPANIED BY AN AUDIBLE BEEP.

2. When the display shows the desired set point, leave the display inactive until the display shows the Home screen.

	Default Set Point	Temperature Range
Refrigerator Zone	38°F (3°C)	34 - 42°F (1 - 6°C)
Freezer Zone	0°F (-18°C)	-4 - 4°F (-20 - -16°C)

SET POINT NAVIGATION

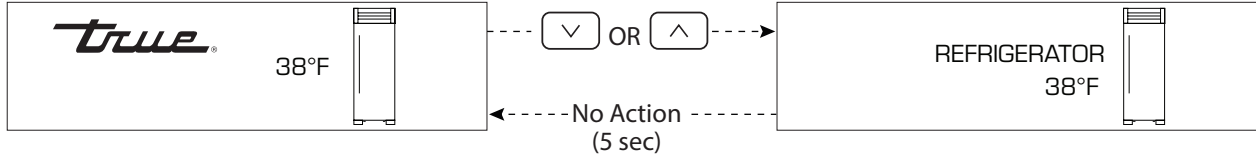
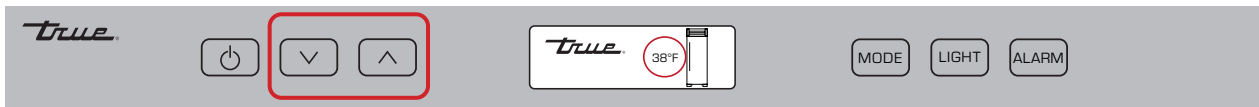

REFRIGERATOR 38°F / FREEZER 0°F

MODE NAVIGATION

This page explains the following models:

- HOLIDAY Mode
- Temperature Unit Selection Mode
- VACATION MODE

HOLIDAY MODE

NOTE: IN HOLIDAY MODE, SET POINTS CANNOT CHANGE AND MANUAL DEFROST CANNOT INITIATE.

The following holds true in accordance with Star-K requirements:

- Freezer defrosting function switch to a fixed time-based sequence.
- The compartment/zone thermistors detect cut-in and cut-out temperatures (determining factor to start/stop cooling), but there is a random 16-21 second delay before cooling begins/ends.
- The display shows HOLIDAY MODE ACTIVE when the door is closed.

VACATION MODE

Vacation mode is operation optimized for energy savings.

MODE NAVIGATION

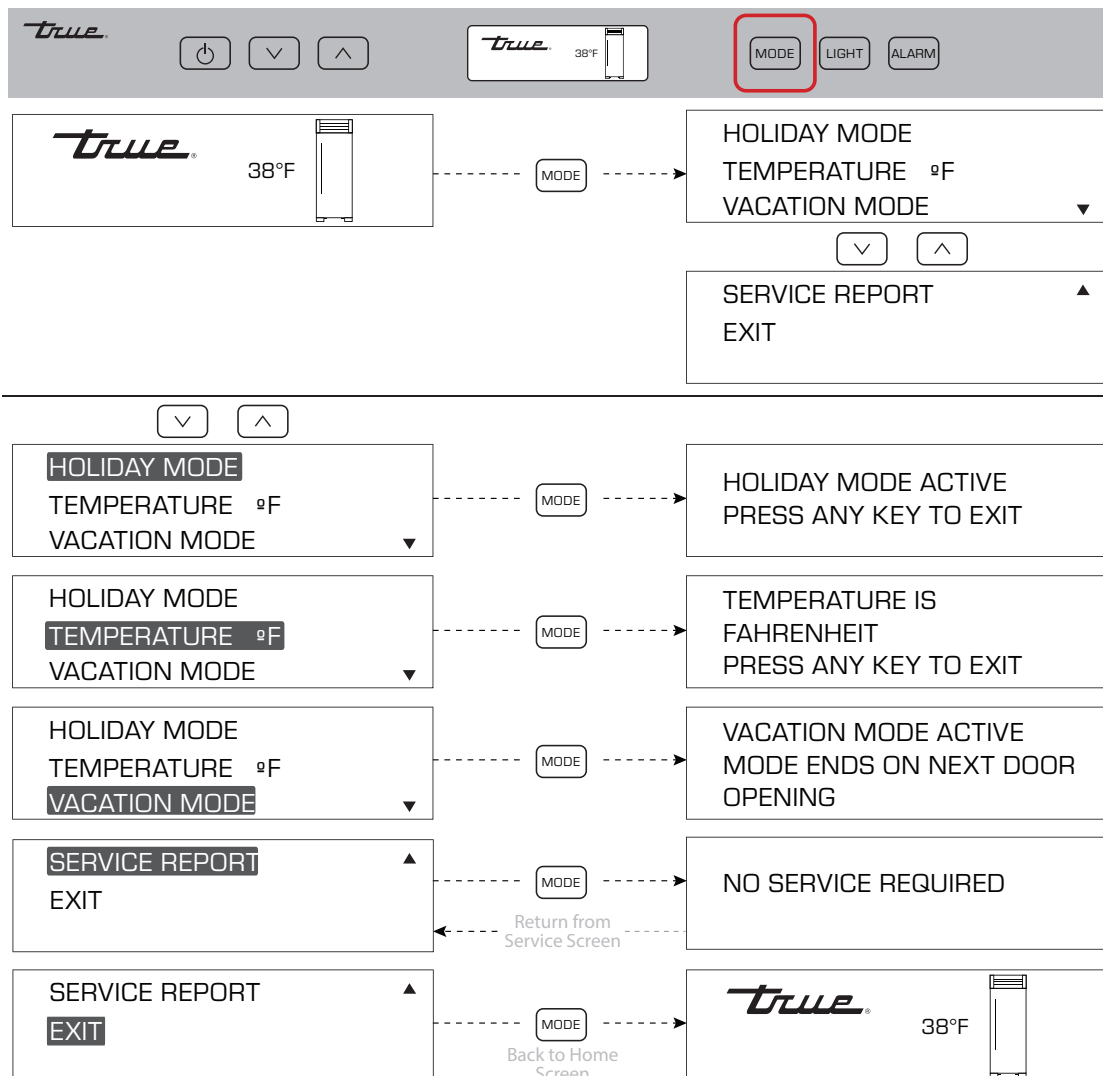



SHOWROOM MODE



SHOWROOM MODE DISABLES THE REFRIGERATION SYSTEM. The appliance will not cool or defrost; however, the lighting system and door ajar alarm system function, and the display shows the set points.

NOTE: ALL MENUS ARE DISPLAY ONLY. ANY SETTING CHANGES WILL NOT AFFECT THE REFRIGERATION SYSTEM'S OPERATION UNTIL SHOWROOM MODE IS OFF.

SHOWROOM MODE ON

1. Press both power  and down  until the display shows the service warning.
2. Press down.
3. Press down until SHOWROOM MODE OFF is selected.
4. With SHOWROOM MODE OFF selected, press MODE.

SHOWROOM MODE OFF

1. Press both power  and down  until the display shows the service warning.
2. Press down.
3. Press down until SHOWROOM MODE ON is selected.
4. With SHOWROOM MODE ON selected, press MODE.

HOME SCREEN

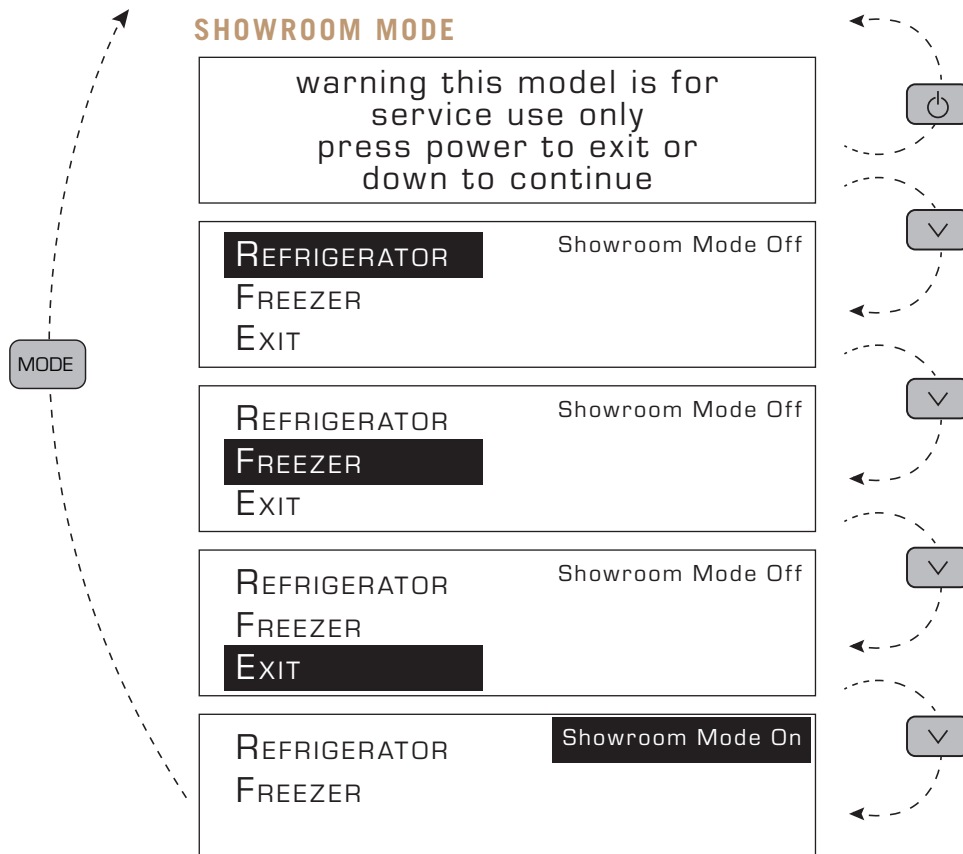
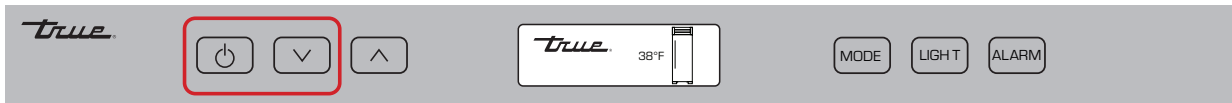

ACCENT LIGHTING SYSTEM

All models are equipped with an accent lighting system in the refrigerator/freezer compartment(s).

PROCEDURE

1. Press LIGHT.
2. With the arrow buttons, navigate to the desired menu option.
3. With the desired option selected, press LIGHT to toggle between options.

LIGHT MODE: Interior lights

BACKLIGHT: Display

ON mode: Stays illuminated when the door is closed.

NOTE: WHEN IN ON MODE, LIGHTS WILL NOT FADE-UP WHEN THE DOOR OPENS.

DOOR mode: Only illuminates when the door is open.

LIGHT NAVIGATION

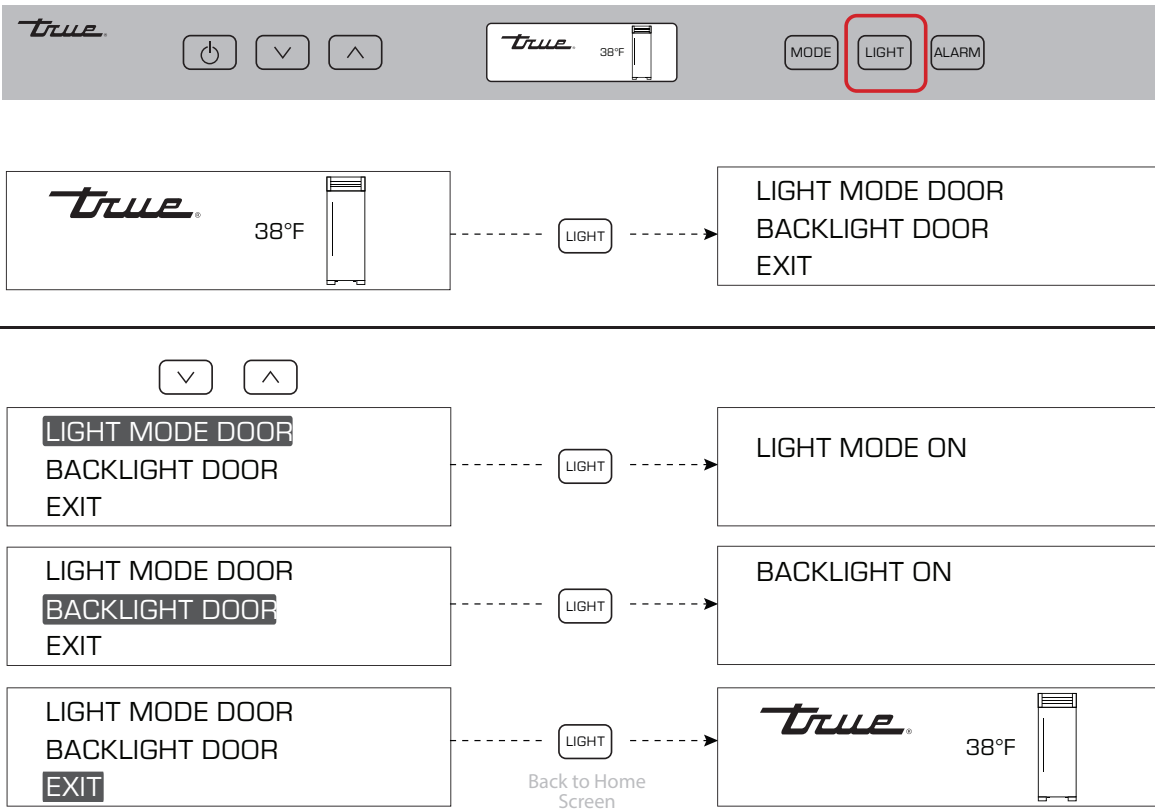

ALARM NAVIGATION (DOOR AJAR ALARM FEATURE ON/OFF)

All models are equipped with a door ajar alarm. The door ajar alarm beeps continuously when the door is left open for more than 5 minutes. During a door ajar alarm, the display shows the notification icons.

ENABLE:

Press ALARM. The display will show DOOR ALARM IS ON.

DISABLE:

Press ALARM. The display will show DOOR ALARM IS OFF.

ALARM NAVIGATION



* TO STOP ALARM BUZZER PRESS 

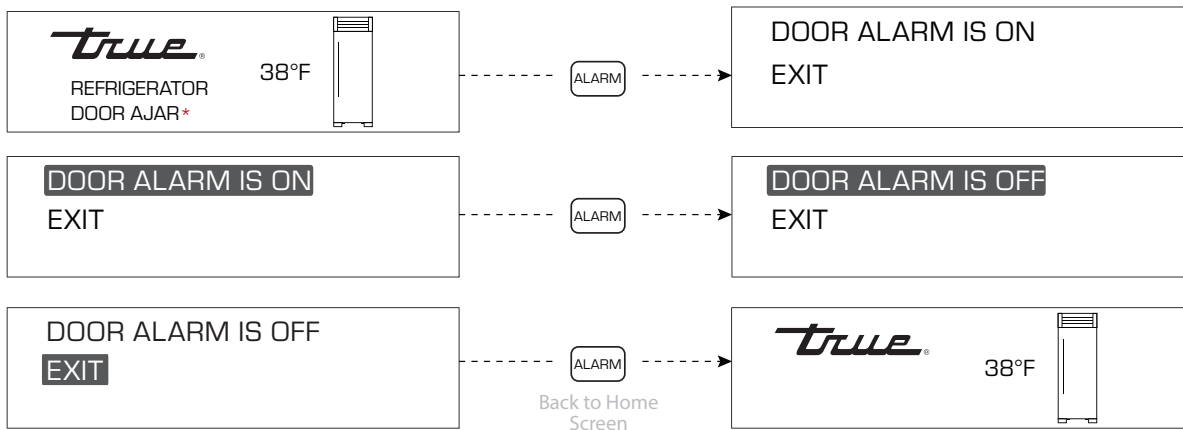

NOTIFICATION ALERTS

The following notification alerts may show on the display if the appliance needs attention.

NOTIFICATION ALERTS

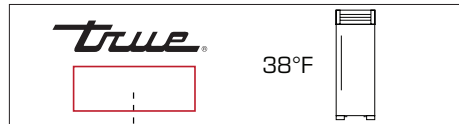
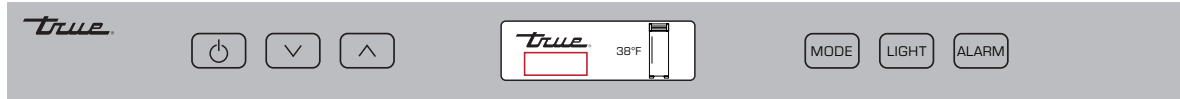

- DEFROST
- HIGH TEMP
- SHOWROOM MODE
- COMMUNICATION ERROR
- SERVICE REQUIRED
- DOOR ALARM

ICE MENU NAVIGATION (OPTIONAL ICEMAKER ONLY)

To enter the Ice Menu, press **ICE** on the user interface. Use the **UP** and **DOWN** arrows to navigate between the menu options and use **ICE** to make a selection. See the diagram below.

The Ice Menu contains three operations.

- Ice Maker: Toggles the icemaker between on/off.
- Max Ice: Maximizes ice production for 24 hours.
- Water Filter Reset: Immediately resets the countdown to change the water filter.



↓ ↑ To change selection (dark highlight/white text)

ICE To toggle **ICE MAKER** and **MAX ICE** between **ON** and **OFF**
Return to home if EXIT is highlighted

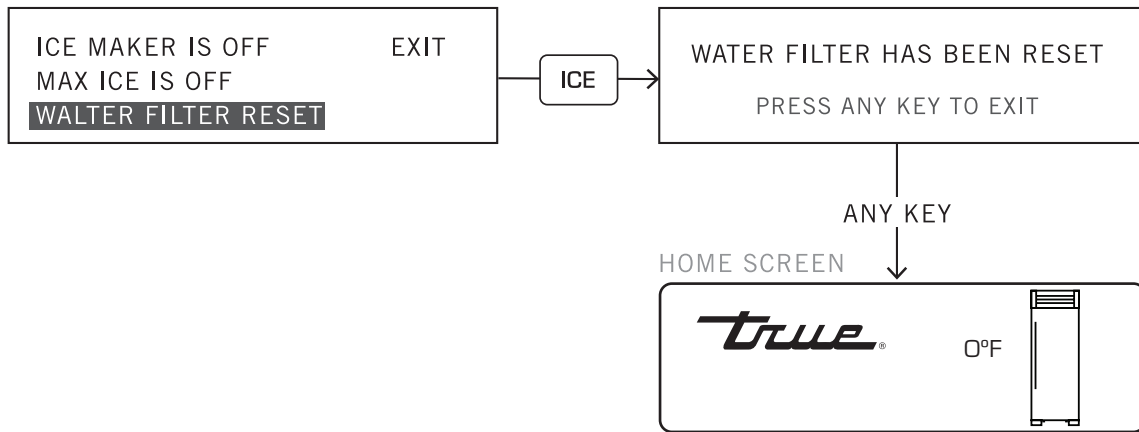

ICE TROUBLESHOOTING

Please see the table below to troubleshoot some common problems with ice production. If your issue is not resolved, please contact True Residential Service at **844-746-9423** or **TrueResidentialService@TrueMfg.com**.

Icemaker Troubleshooting	
No ice	<ul style="list-style-type: none"> • Verify the water filter is installed • Verify water is being supplied to the unit • Verify the icemaker is on and has been running for at least 24 hours • Verify the ice bin is positioned correctly • Verify the freezer temperature is near 0° • Verify the water filter has been replaced within the last 12 months and has been installed correctly
Black flecks in the ice cubes	Stop use and contact True Residential Technical Service
Bad taste	<ul style="list-style-type: none"> • Defrost the freezer and clean with soap and water • Place coffee grounds or charcoal briquettes in the freezer to absorb odor
Hollow cubes	Clean the condenser coil. Contact True Residential Customer Service if the issue is unresolved.

DUAL ZONE TURN ON/OFF

DUAL ZONE TEMPERATURE ADJUSTMENT

DUAL ZONE MODE NAVIGATION

DUAL ZONE SHOWROOM MODE

DUAL ZONE ACCENT LIGHTING SYSTEM

DUAL ZONE ALARM NAVIGATION

DUAL ZONE NOTIFICATION ALERTS

DUAL ZONE ICE MENU NAVIGATION (OPTIONAL ICEMAKER ONLY)



PRESERVE THE MOMENT®

DUAL ZONE OPERATION

TURN ON/OFF

All units are shipped in **ON** mode. During the initial startup, the unit runs a short power up diagnostic followed by a single audible beep. The lights turn on and temperature readings appear on the display.



WARNING! Electrical shock or burn hazard. Turning the unit off with the power button does not remove the power supply from the control. Unplug the unit or turn off the power supply.

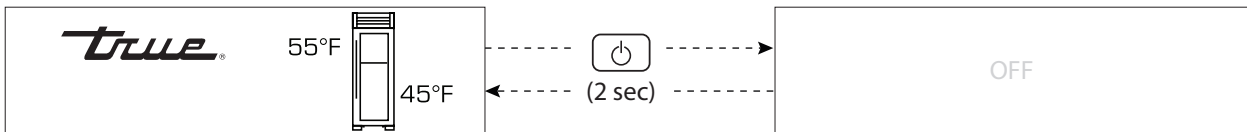
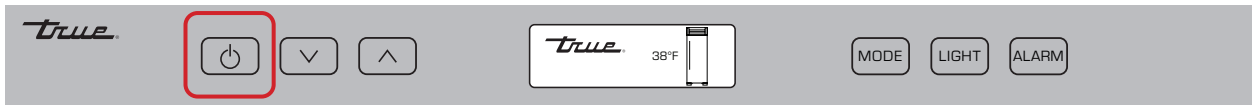
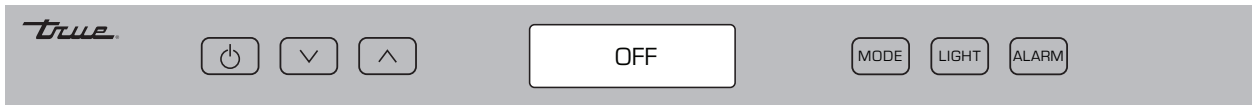

PLEASE NOTE THAT THOUGH THE DISPLAY CAN SHOW EITHER FAHRENHEIT OR CELSIUS, IN MOST CASES THE FIGURES SHOW FAHRENHEIT.

HOME SCREEN ON / OFF



DUAL ZONE OPERATION

TEMPERATURE ADJUSTMENT

1. Press ZONE until the display selects the desired zone.
2. Press down  or up  until the display shows the desired set point.

	Default Set Point	Temperature Range
Upper Zone	55°F (12.7°C)	40 - 65°F (4.4 - 18.3°C)
Lower Zone	45°F (7.2°C)	40 - 65°F (4.4 - 18.3°C)

NOTE: A BUTTON PRESS CHANGES THE SET POINT BY 1° AND IS ACCOMPANIED BY AN AUDIBLE BEEP.

3. When the display shows the desired set point, press ZONE or leave the display inactive until the display shows the Home screen.

SET POINT NAVIGATION

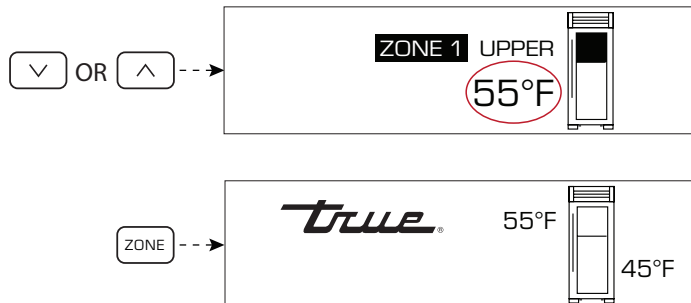
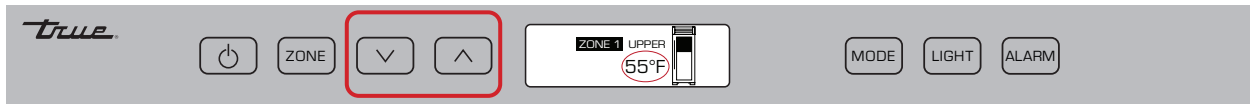
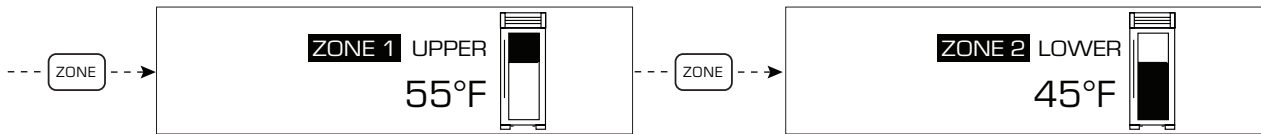

UPPER ZONE 55°F / LOWER ZONE 45°F

MODE NAVIGATION

This page explains the following models:

- HOLIDAY Mode
- Temperature Unit Selection Mode
- VACATION MODE

HOLIDAY MODE

NOTE: IN HOLIDAY MODE, SET POINTS CANNOT CHANGE AND MANUAL DEFROST CANNOT INITIATE.

The following holds true in accordance with Star-K requirements:

- Freezer defrosting function switch to a fixed time-based sequence.
- The compartment/zone thermistors detect cut-in and cut-out temperatures (determining factor to start/stop cooling), but there is a random 16-21 second delay before cooling begins/ends.
- The display shows HOLIDAY MODE ACTIVE when the door is closed.

VACATION MODE

Vacation mode is operation optimized for energy savings.

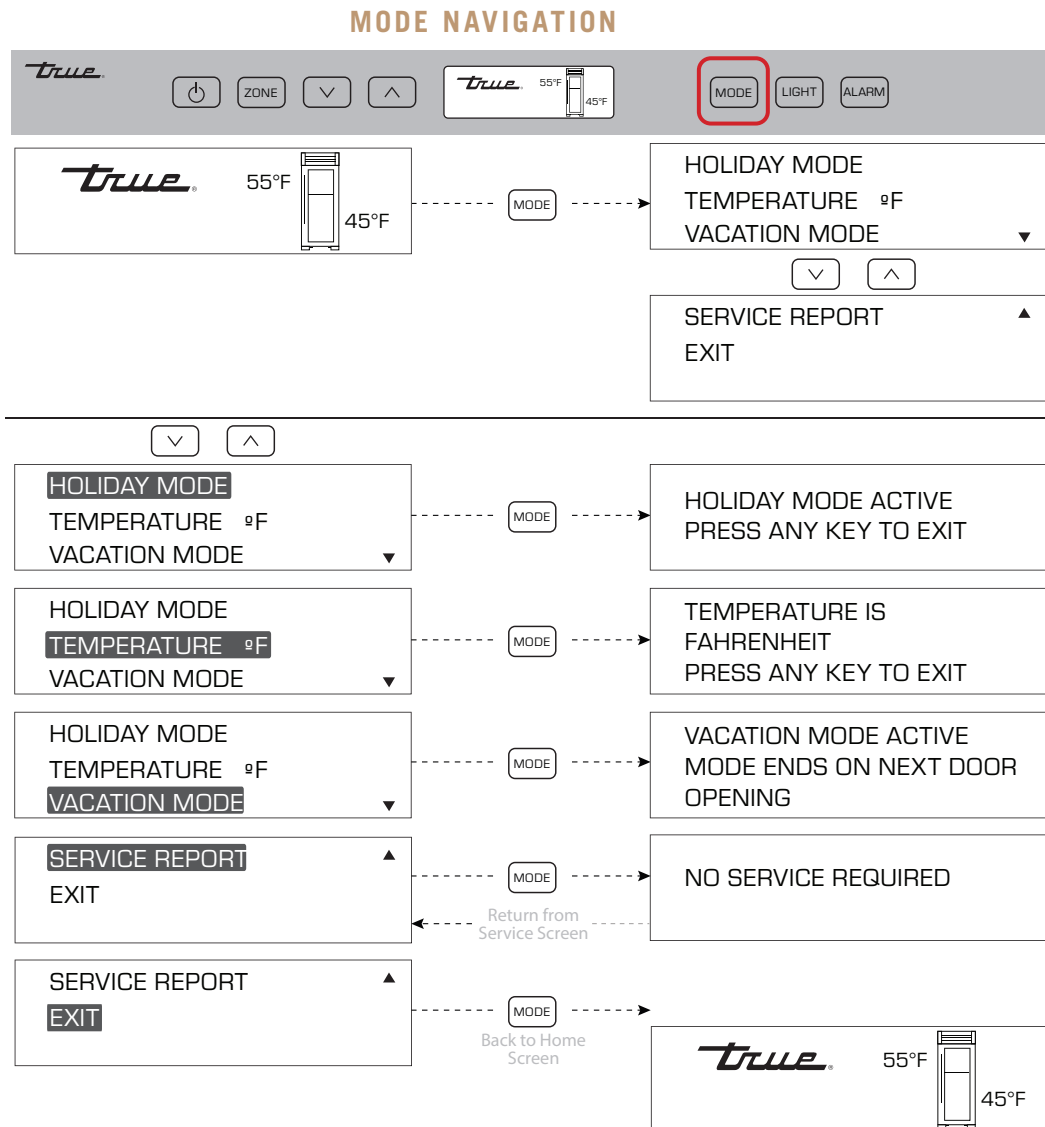



SHOWROOM MODE



SHOWROOM MODE DISABLES THE REFRIGERATION SYSTEM. The appliance will not cool or defrost; however, the lighting system and door ajar alarm system function, and the display shows the set points.

NOTE: ALL MENUS ARE DISPLAY ONLY. ANY SETTING CHANGES WILL NOT AFFECT THE REFRIGERATION SYSTEM'S OPERATION UNTIL SHOWROOM MODE IS OFF.

SHOWROOM MODE ON

1. Press both power  and down  until the display shows the service warning.
2. Press down.
3. Press down until SHOWROOM MODE OFF is selected.
4. With SHOWROOM MODE OFF selected, press MODE.

SHOWROOM MODE OFF

1. Press both power  and down  until the display shows the service warning.
2. Press down.
3. Press down until SHOWROOM MODE ON is selected.
4. With SHOWROOM MODE ON selected, press MODE.

HOME SCREEN

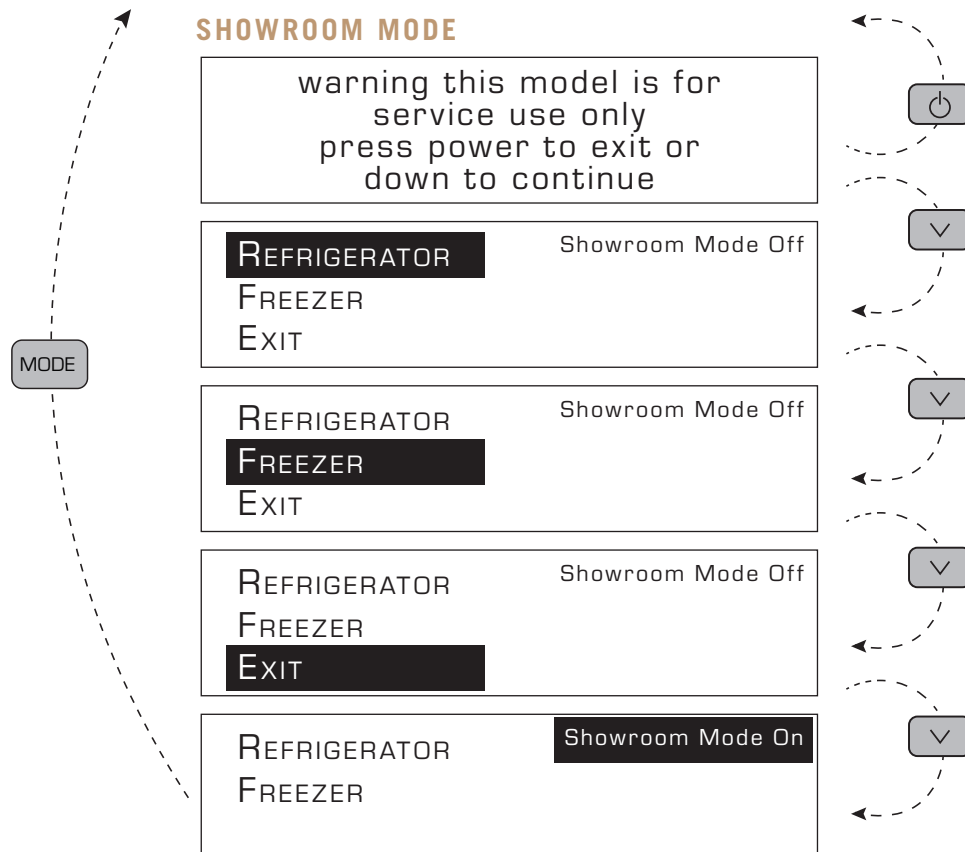
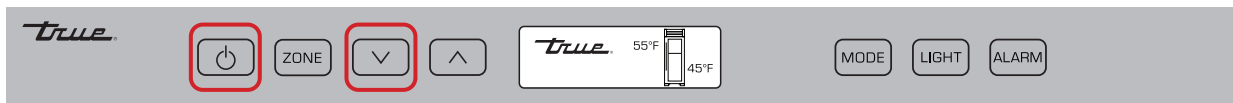

DUAL ZONE OPERATION

ACCENT LIGHTING SYSTEM

All models are equipped with an accent lighting system in the refrigerator/freezer compartment(s).

PROCEDURE

1. Press LIGHT
2. With the arrow buttons, navigate to the desired menu option.
3. With the desired option selected, press LIGHT to toggle between options.

LIGHT MODE: Interior lights

BACKLIGHT: Display

ON mode: Stays illuminated when the door is closed.

NOTE: WHEN IN ON MODE, LIGHTS WILL NOT FADE-UP WHEN THE DOOR OPENS.

DOOR mode: Only illuminates when the door is open.

CHANGE TRULUMINA® LIGHT COLOR

PROCEDURE

1. Press LIGHT until the display shows CHANGE COLOR.
2. With the display showing CHANGE COLOR, press LIGHT. The appliance will cycle through the light color options.
3. When the light is the desired color, press LIGHT.



LIGHT NAVIGATION

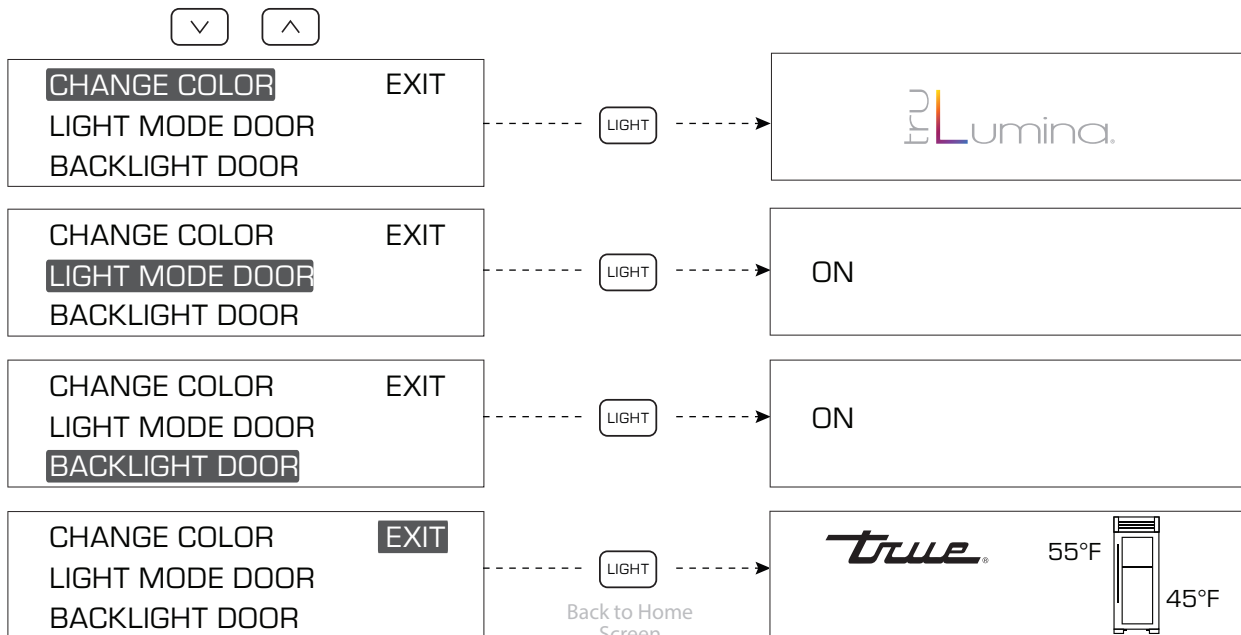
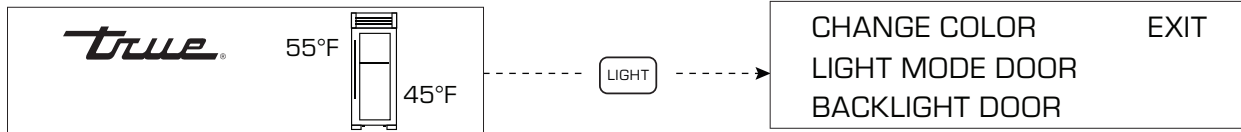
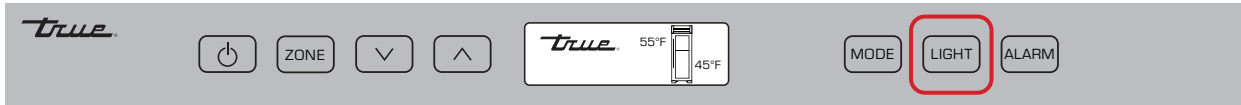

DUAL ZONE OPERATION

ALARM NAVIGATION (DOOR AJAR ALARM FEATURE ON/OFF)

All models are equipped with a door ajar alarm. The door ajar alarm beeps continuously when the door is left open for more than 5 minutes. During a door ajar alarm, the display shows the notification icons.

ENABLE:

Press ALARM. The display will show DOOR ALARM IS ON.

DISABLE:

Press ALARM. The display will show DOOR ALARM IS OFF.

ALARM NAVIGATION

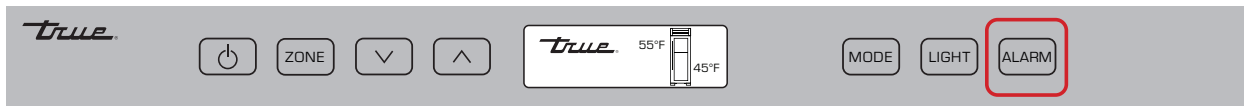

* TO STOP ALARM BUZZER PRESS 

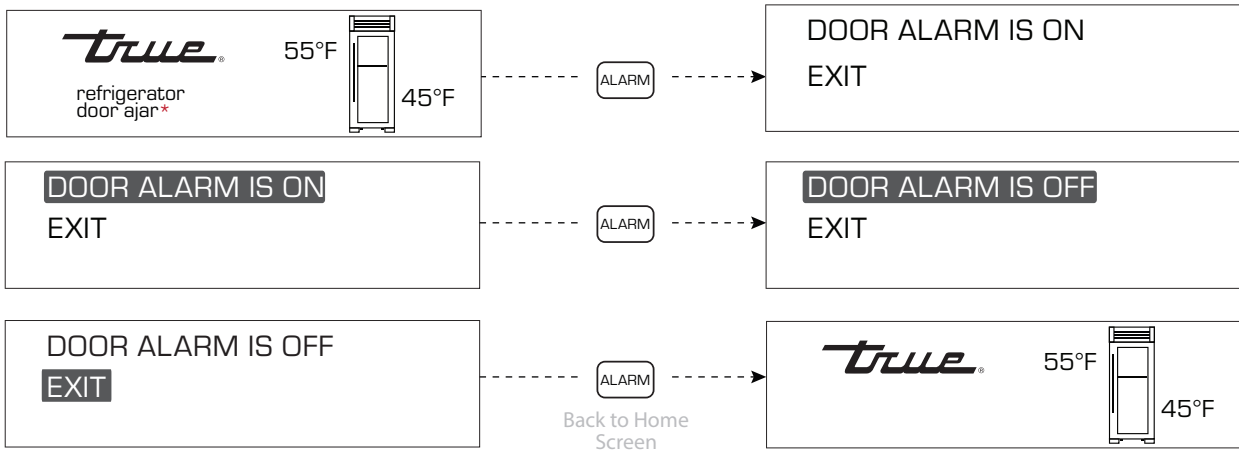

NOTIFICATION ALERTS

The following notification alerts may show on the display if the appliance needs attention.

NOTIFICATION ALERTS

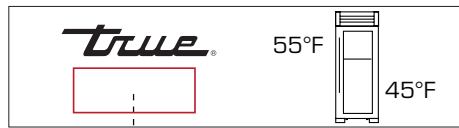
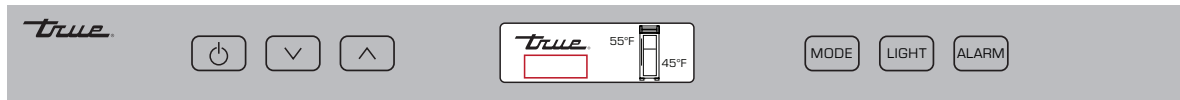

- DEFROST
- HIGH TEMP
- SHOWROOM MODE
- COMMUNICATION ERROR
- SERVICE REQUIRED
- DOOR ALARM
- ZONE 1 UPPER HIGH TEMP
- ZONE 2 LOWER HIGH TEMP

DOOR REMOVAL

CONDENSER COIL CLEANING

CONDENSATION

HANDLE TIGHTENING

WATER FILTER REPLACEMENT

STAINLESS STEEL EQUIPMENT CARE AND CLEANING

SERIAL LABEL LOCATION

CONTACT US

WARRANTY



PRESERVE THE MOMENT®

DOOR REMOVAL

REMOVAL

1. Open the rainshield. See fig. 1.
2. Open the door 90°. See fig. 2.
3. Carefully lift the door from the hinges. See fig. 3

INSTALLATION

1. Open the rainshield. See fig. 1.
2. Hold the door 90° to the opening.
3. Align the hinge posts with the hinges.
4. Lower the door into place.

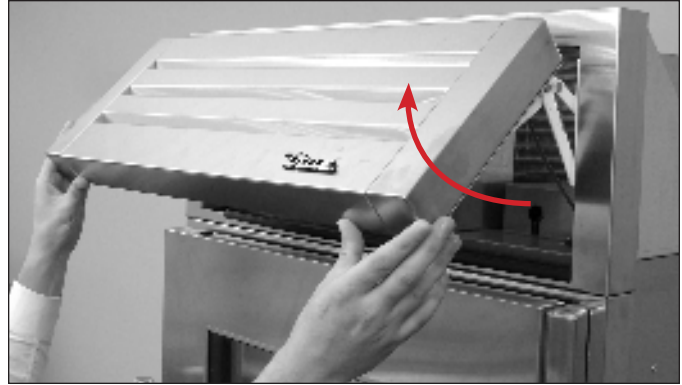

FIG. 1. Open the rainshield.

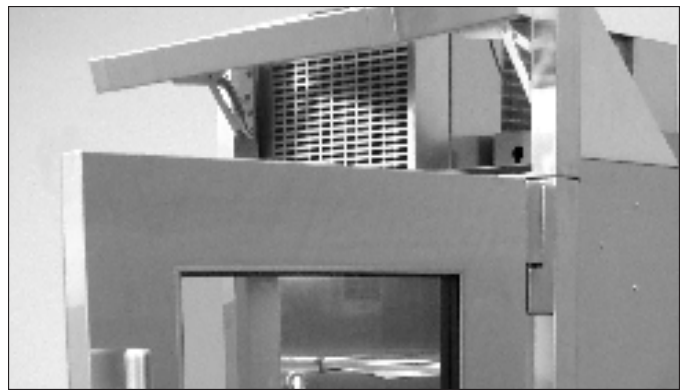

FIG. 2. Open the door 90°.

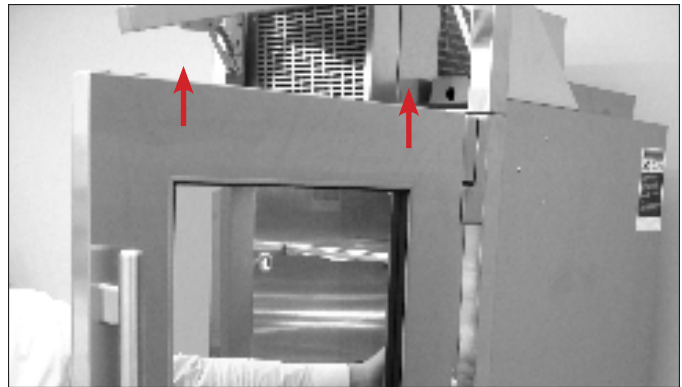

FIG. 3. Lift the door up.

CONDENSER COIL CLEANING

Keeping the condenser coil clean minimizes required servicing and lowers electrical cost. Warranty does not cover cleaning the condenser coil.



WARNING! Electrical shock or burn hazard. Unplug the unit or turn off the power supply before proceeding. **DO NOT** clean appliance with a pressure washer or hose.



CAUTION! Risk of eye injury from debris. Eye protection is recommended.



CAUTION! Coil fins are sharp. Gloves are recommended.

REQUIRED TOOLS

- Stiff-bristled brush
- Vacuum Cleaner
- Gloves (recommended)

PROCEDURE

1. Open the rainshield. See fig. 1.
2. With a stiff-bristled brush, carefully clean accumulated dirt from the condenser coil fins. See fig. 2.

NOTE: NEVER BRUSH ACROSS THE COIL FINNS.

3. Carefully vacuum any dirt around the condensing unit area.
4. Close the rainshield.

CONDENSATION

Leaving the doors and/or drawers open for long periods of time or running a unit with little/no product inside may cause excessive condensation.

HANDLE TIGHTENING

Tighten handles with a 3/32" Allen wrench.



FIG. 1. Opened rainshield.

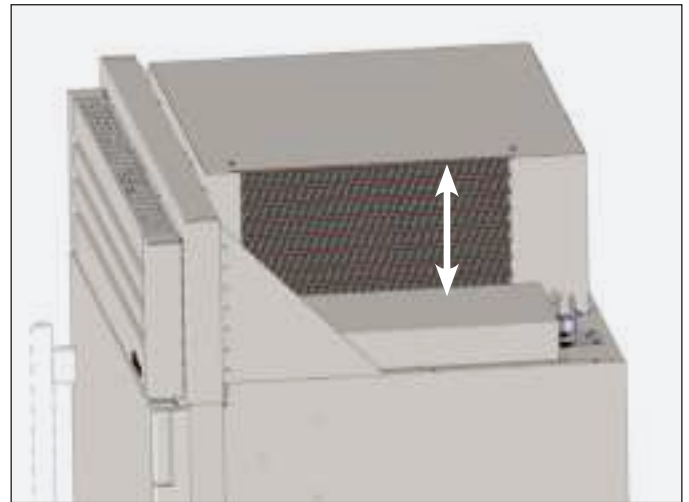

FIG. 2. Never brush across coil fins.

WATER FILTER REPLACEMENT (OPTIONAL ICEMAKER ONLY)

The ice machine water has a life expectancy of 300 gal (1,136 L) or six months. When the water filter reaches the end of its life, the control display shows WATER FILTER.

To order a replacement water filter, go to <https://store.trueresidential.com/collections/maintenance-1> or contact our parts department at **844-849-6226** or **TrueResidentialParts@TrueMfg.com**.

Follow the instruction below to change the water filter. For information on clearing the water filter notification, please see “Ice Menu Navigation” (page 55).

PROCEDURE

1. Remove the kickplate. See fig. 1.
2. Rotate the water filter counterclockwise and pull the filter from the unit. See fig. 2.
3. Insert the replacement water filter and rotate the filter clockwise. See fig. 3.
4. Reinstall the kickplate.

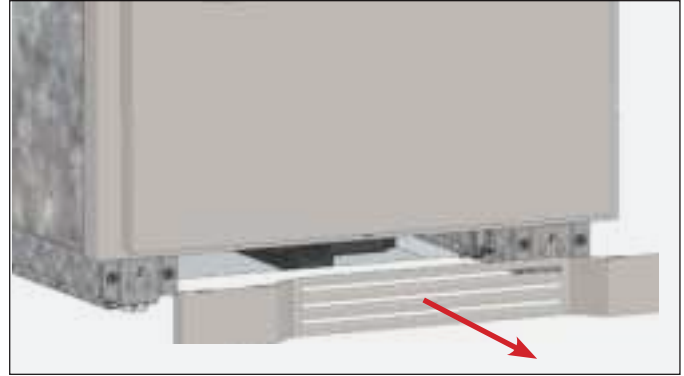

FIG. 1. Pull the kickplate from the cabinet.

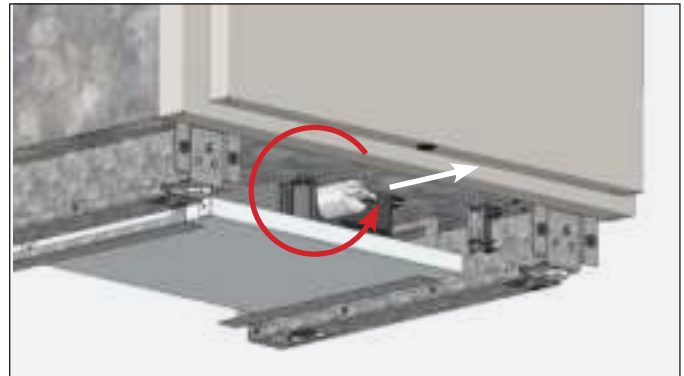

FIG. 2. Rotate the existing water filter counterclockwise.

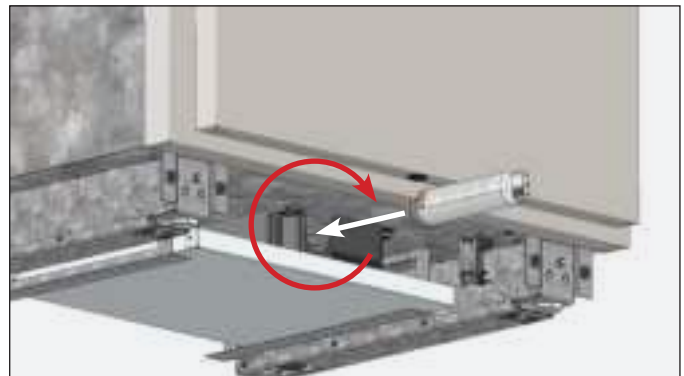

FIG. 3. Insert the new water filter and rotate it clockwise.

STAINLESS STEEL EQUIPMENT CARE AND CLEANING



NOTE! DO NOT USE ANY STEEL WOOL, ABRASIVE OR CHLORINE BASED PRODUCTS TO CLEAN STAINLESS STEEL SURFACES.

STAINLESS STEEL OPPONENTS

There are three basic things which can break down your stainless steel’s passivity layer and allow corrosion to rear its ugly head.

- Scratches from wire brushes, scrapers, and steel pads are just a few examples of items that can be abrasive to stainless steel’s surface.
- Deposits left on your stainless steel can leave spots. You may have hard or soft water depending on what part of the country you live in. Hard water can leave spots. Hard water that is heated can leave deposits if left to sit too long. These deposits can cause the passive layer to break down and rust your stainless steel. All deposits left from food prep or service should be removed as soon as possible.
- Chlorides are present in table salt, food, and water. Household and industrial cleaners are the worst type of chlorides to use.

STAINLESS STEEL CLEANING AND RESTORATION

Do not use stainless steel cleaners or similar solvents to clean plastic or powder-coated parts. Instead, use warm soapy water.

- For routine cleaning and removal of grease and oil, apply white vinegar, ammonia, or any good commercial detergent* with a soft cloth or sponge.
- Stainless steel polish (i.e., Zep® Stainless Steel Polish, Weiman® Stainless Steel Cleaner & Polish, Nyco® Stainless Steel Cleaner & Polish, or Ecolab® Ecoshine®) and olive oil can act as a barrier against fingerprints and smears.
- Degreasers* (i.e., Easy-Off® Specialty Kitchen Degreaser or Simple Green® Industrial Cleaner & Degreaser) are excellent for removal of grease, fatty acids, blood and burnt-on foods on all surfaces.
- For restoration/passivation or removing stubborn stains and discoloration, Brillo® Cameo®, Zud® Cleanser, Ecolab® Specifix™ First Impression® Metal Polish, Sheila Shine, or talc can be applied by rubbing in the direction of the polish lines.

***DO NOT USE DETERGENTS OR DEGREASERS WITH CHLORIDES OR PHOSPHATES.**

STAINLESS STEEL EQUIPMENT CARE AND CLEANING

8 TIPS TO HELP PREVENT RUST ON STAINLESS STEEL

- **Maintain the Cleanliness of Your Equipment** – Avoid build-up of hard stains by cleaning frequently. Use cleaners at the recommended strength (alkaline chlorinated or non-chloride).
- **Use the Correct Cleaning Tools** – Use non-abrasive tools when cleaning your stainless steel products. The stainless steel's passive layer will not be harmed by soft cloths and plastic scouring pads.
- **Clean Along Polishing Lines** – Polishing lines ("grain") are visible on some stainless steels. Always scrub parallel to polishing lines when visible. Use a plastic scouring pad or soft cloth when you cannot see the grain.
- **Use Alkaline, Alkaline-Chlorinated or Non-Chloride Cleaners** – While many traditional cleaners are loaded with chlorides, the industry is providing an ever increasing choice of non-chloride cleaners. If you are not sure of your cleaner's chloride content, contact your cleaner supplier. If they tell you that your present cleaner contains chlorides, ask if they have an alternative. Avoid cleaners containing quaternary salts, as they can attack stainless steel, causing pitting and rusting.
- **Rinse** – When using chlorinated cleaners, you must rinse and wipe dry immediately. It is better to wipe standing cleaning agents and water as soon as possible. Allow the stainless steel equipment to air dry. Oxygen helps maintain the passivity film on stainless steel.
- **Never Use Hydrochloric Acid (Muriatic Acid) on Stainless Steel** – Even diluted, hydrochloric acid can cause corrosion, pitting and stress corrosion cracking of stainless steel.
- **Water Treatment** – To reduce deposits, soften hard water when possible. Installation of certain filters can remove corrosive and distasteful elements. Salts in a properly maintained water softener can also be to your advantage. Contact a treatment specialist if you are not sure of the proper water treatment.
- **Regularly Restore & Passivate Stainless Steel** – Stainless steel gets its stainless properties from the protective chromium oxides on its surface. If these oxides are removed by scouring, or by reaction with harmful chemicals, then the iron in the steel is exposed and can begin to oxidize, or rust. Passivation is a chemical process that removes free iron and other contaminants from the surface of stainless steel, allowing the protective chromium oxides to re-form.

SERIAL LABEL LOCATION

The serial label is located on the left wall near the freezer wire basket or the refrigerator upper drawer.

This label contains important information such as your model name and serial number. Please have this information on hand when contacting True so we can better assist you with your service -or parts- related inquiries.



FIG. 1. Serial label location.

CONTACT US

CUSTOMER SERVICE

Phone: 888-616-8783
info@true-residential.com

WARRANTY DEPARTMENT

Phone: 844-849-6179
trueresidentialwarranty@truemfg.com

SERVICE DEPARTMENT

Phone: 844-746-9423
TrueResidentialService@truemfg.com

NOTES

NOTES

TRUE RESIDENTIAL® SERIES LIMITED WARRANTY STATEMENT

LIMITED 30 DAY COSMETIC WARRANTY

Stainless steel doors, handles, and shelves are warranted to be free from defective materials or workmanship for a period of thirty (30) days from the date of original retail purchase. Any defects must be reported to the selling dealer within thirty (30) days from the date of original retail purchase. This limited warranty excludes any type of freight / concealed damage.

THREE-YEAR PARTS & LABOR WARRANTY *For units purchased after Feb 1, 2013

TRUE® warrants to the original purchaser of every new TRUE refrigerated unit, the cabinet and all parts thereof, to be free from defects in material or workmanship under normal and proper use and maintenance as specified by TRUE and upon proper installation and start-up in accordance with the instruction packet supplied with each TRUE unit. TRUE's obligation under this warranty is limited to a period of three (3) years from the date of original installation or thirty nine (39) months after shipment date from TRUE, whichever occurs first. Contact the factory regarding warranty for installations in a commercial/light commercial application.

SIX-YEAR SEALED SYSTEM WARRANTY – PARTS & LABOR *For units purchased after Feb 1, 2013

TRUE warrants its hermetically sealed system: compressor, evaporator coil, condenser coil, drier, metering device and connecting tubing to be free from defects in both material and workmanship under normal and proper use and maintenance service for a period of six (6) years from the date of original installation but not to exceed six (6) years and three (3) months after shipment from the manufacturer, whichever occurs first.

SEVEN THROUGH TWELVE-YEAR SEALED SYSTEM WARRANTY – PARTS ONLY

*For units shipped from True after Feb 1, 2017 and REGISTERED via TRUE's Product Registration Page – TRUE warrants its hermetically sealed system: compressor, evaporator coil, condenser coil, drier, metering device and connecting tubing to be free from defects in both material and workmanship under normal and proper use and maintenance service period of Twelve (12) years from the date of original installation but not to exceed twelve (12) years and three (3) months after shipment from the manufacturer, whichever occurs first. Product must be registered with TRUE within 12 months of the unit's installation to qualify for this warranty. Factory seconds and clear Ice machines are excluded from this warranty.

DISPLAY PRODUCTS

True Residential Products on showroom display that are sold more than 3 years (36 months) from the invoice date to the dealer would carry a 1 year parts and labor warranty, along with an additional 4 year sealed system, parts only warranty.

ADA-COMPLIANT PRODUCTS

True Residential ADA-Compliant models have a separate warranty that is two years parts and labor with an additional three years parts only on the compressor. Full statement can be found under the ADA product Installation Guide.

TERMS APPLICABLE TO EACH WARRANTY

Any part covered under the above warranties that is determined by TRUE to have been defective within the time frame is limited to the repair or replacement, including labor charges, of defective parts or assemblies. The labor warranty shall include standard straight time labor charges only and reasonable travel time, as determined by TRUE.

WARRANTY CLAIMS

All claims for labor or parts must be made directly through TRUE. All claims should include: model number and serial number of cabinet, proof of purchase, and date of installation. In case of warranted compressor, the compressor model tag must be returned to TRUE along with the above listed information.

WHAT IS NOT COVERED BY THIS WARRANTY

TRUE's sole obligation under this warranty is limited to either repair or replacement of parts, subject to the additional limitations below. This warranty neither assumes nor authorizes any person to assume obligations other than those expressly covered by this warranty.

NO CONSEQUENTIAL DAMAGES

TRUE is not responsible for economic loss, profit loss; or special, indirect or consequential damages, including without limitation, losses or damages arising from food or product spoilage claims whether or not on account or refrigeration failure.

WARRANTY IS NOT TRANSFERABLE

This warranty is not assignable and applies only in favor of the original purchaser/user to whom delivered. Any such assignment or transfer shall void the warranties herein made and shall void all warranties, express or implied, including any warranty or merchantability or fitness for a particular purpose.

IMPROPER USAGE

TRUE assumes no liability for parts or labor coverage for component failure or other damages resulting from improper usage or installation or failure to clean and/or maintain product as set forth in the warranty packet provided with the unit.

ALTERATION OR NEGLECT

TRUE is not responsible for the repair or replacement of any parts that TRUE determines have been subjected after the date of manufacture to alteration, neglect, abuse, misuse, accident, damage during transit or installation, fire, flood, or act of God.

IMPROPER ELECTRICAL CONNECTIONS

TRUE is not responsible for the repair or replacement of failed or damaged components resulting from electrical power failure, high or low voltage, use of extension cords, or improper grounding of the unit.

YOUR RIGHTS UNDER STATE LAW

This warranty gives you specific legal rights and you may have other rights that vary from state to state. Some states do not allow the exclusion or limitation of consequential damages or a limitation on how long an implied warranty lasts, so the above exclusion or limitation may not apply to you.

ENVIRONMENTAL ATTRIBUTES

Any and all environmental attributes, including environmental offset credit rights, with respect to TRUE refrigeration units manufactured after September 1, 2015, shall remain the property of TRUE Manufacturing Co., Inc. and are not transferred.

OUTSIDE U.S./CANADA

This warranty does not apply to, and TRUE is not responsible for, any warranty claims made on products sold or used outside the United States or Canada.

SUBMIT WARRANTY CLAIMS TO: True Residential
2001 East Terra Lane
O'Fallon MO 63366
TrueResidentialWarranty@truemfg.com

BP_06.2021_166956

CONTACT US

true-residential.com

636.240.2400 | toll free 888.616.8783



212530

AL_190909_07.22