

QUICK REFERENCE GUIDE



TOYOTA

**COROLLA CROSS
COROLLA CROSS
HYBRID**

2024



2024

COROLLA CROSS / COROLLA CROSS HYBRID

This Quick Reference Guide is a summary of basic vehicle operations. It contains brief descriptions of fundamental operations so you can locate and use the vehicle's main equipment quickly and easily.

The Quick Reference Guide is not intended as a substitute for the Owner's Manual located in your vehicle's glove box. We strongly encourage you to review the Owner's Manual and supplementary manuals so you will have a better understanding of your vehicle's capabilities and limitations.

Your dealership and the entire staff of Toyota Motor North America, Inc. wish you many years of satisfied driving in your new Corolla Cross.

A word about safe vehicle operations

This Quick Reference Guide is not a full description of Corolla Cross operations. Every Corolla Cross owner should review the Owner's Manual that accompanies this vehicle.

Pay special attention to the boxed information highlighted in color throughout the Owner's Manual. Each box contains operating instructions to help you avoid injury or equipment malfunction.

All information in this Quick Reference Guide is current at the time of printing. Toyota reserves the right to make changes at any time without notice.

INDEX

OVERVIEW

Engine maintenance	11
Fuel tank door release & cap	10
Hood release	10
Indicator symbols	6-7
Instrument cluster	4-5
Instrument panel	2-3
Instrument panel light control	9
Keyless entry ^{1,2}	8-9
Smart Key system ^{1,2}	9

FEATURES & OPERATIONS

Air conditioning/heating ^{1,2}	28-29
Audio Multimedia	24
Auto lock/unlock ^{1,2}	14
Blind Spot Monitor (BSM) and Rear Cross Traffic Alert (RCTA) ²	34
Bottle holders	19
Clock	24
Continuously variable transmission/ Hybrid transmission	12
Cup holders	19
Door lock switches ^{1,2}	14
Driving mode select switch	31
Electric parking brake	18-19
EV drive mode	31
Front and Rear Parking Assist with Automatic Braking (PA w/AB) ²	36
Front seats-Adjustments	16
Garage door opener ³	25
Heated seats	27
Hybrid Synergy Drive System	13
Intuitive Parking Assist ²	33
Lights ^{1,2} & turn signals	22-23
Moonroof ¹	15
Multi-Information Display (MID) ^{1,2}	20
Power outlet-12V DC	26
Power windows ¹	14
Qi Wireless charger	27
Rear door-Power Liftgate ²	17
Rear seats-Folding	16
Rear view monitor system	32
Safe Exit Assist (SEA) ²	35
Seats-Head restraints	16

FEATURES & OPERATIONS (continued)

Steering lock release	15
Steering wheel switches & telephone controls (Bluetooth®)	21
Stop & Start Engine System ²	30
Tilt & telescopic steering wheel	15
USB Type-C charge ports	26
USB Type-C media port	26
Vehicle Stability Control (VSC)/ TRAC OFF switch	32
Windshield wipers & washers	23

TOYOTA SAFETY SENSE™ 3.0

Automatic High Beams (AHB)	51-52
Cruise Control	49-50
Full-Speed Range Dynamic Radar Cruise Control (DRCC)	46-49
Lane Departure Alert (LDA) with Steering Assist	43-45
Lane Tracing Assist (LTA)	42
Over-The-Air (OTA) Updates	38
Pre-Collision System with Pedestrian Detection (PCS w/PD)	39-41
Proactive Driving Assist (PDA)	54-56
Quick overview- Toyota Safety Sense™ 3.0	37-38
Road Sign Assist (RSA)	52-53
Sensors	38

SAFETY & EMERGENCY FEATURES

Floor mat installation	64
Rear door child safety locks	58
Safety Connect®	58
Seat belts	57
Seat belts-Shoulder belt anchor	57
Spare tire & tools	60-61
Star Safety System™	63-64
Tire Pressure Monitoring (warning) System (TPMS)	62
Tire repair kit & tools	59

GETTING STARTED WITH TOYOTA AUDIO MULTIMEDIA AND CONNECTED SERVICES	66-77
--	-------

¹ Visit your Toyota dealer for information on customizing this feature.

² Programmable by customer. Refer to the "Owner's Manual" for instructions and more information.

³ HomeLink® is a registered trademark of Gentex Corporation.

Instrument panel

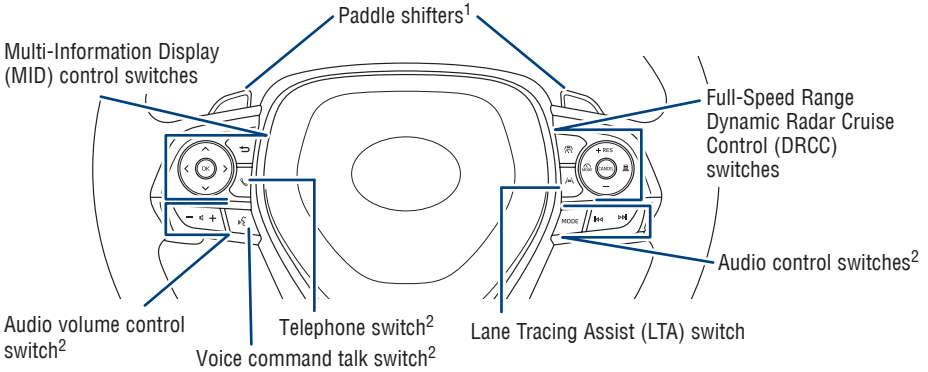

Steering wheel controls

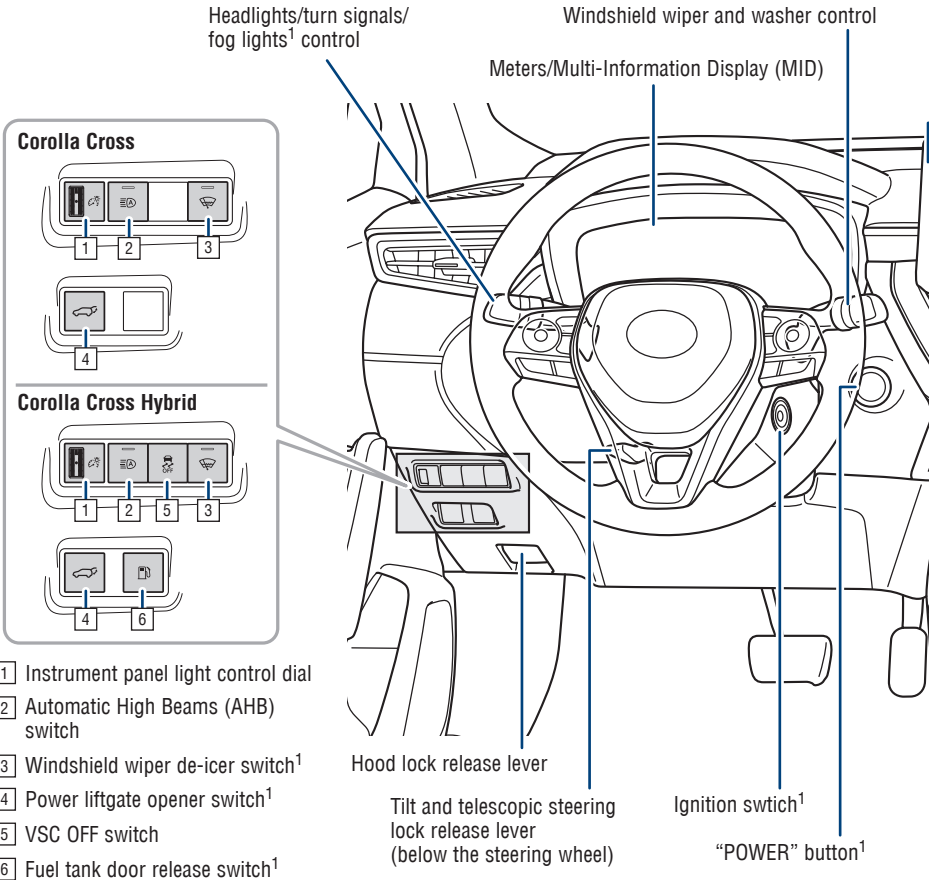

¹ If equipped.

² For details, refer to the "Owner's Manual", "Multimedia Owner's Manual" or visit www.toyota.com/audio-multimedia for additional resources.

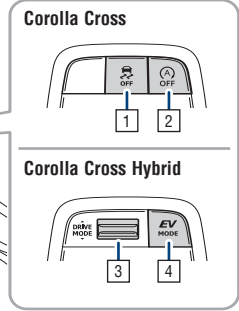
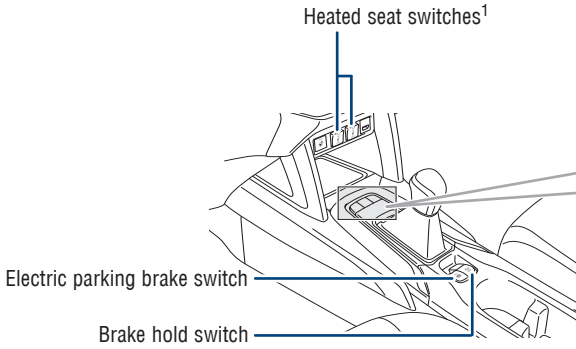

- 1 VSC OFF switch
- 2 Stop & Start cancel switch
- 3 Driving mode select switch
- 4 EV drive mode switch

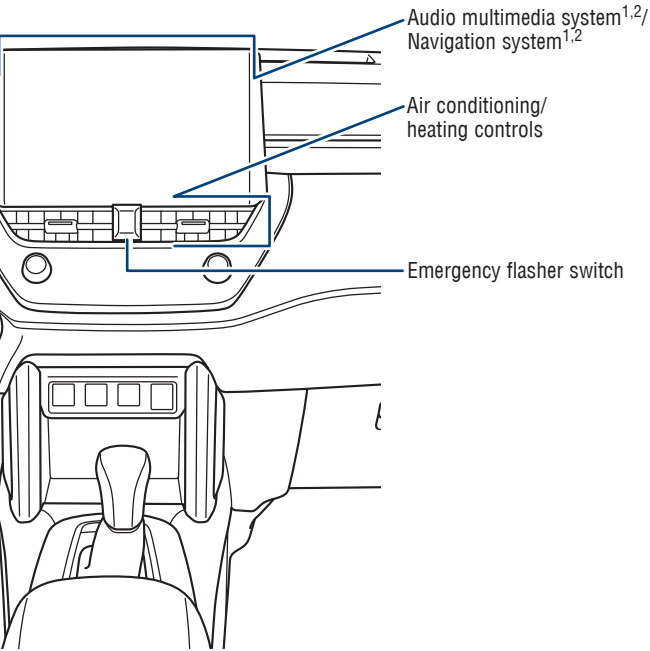

Instrument cluster

COROLLA CROSS

Vehicles equipped with 4.2-in display

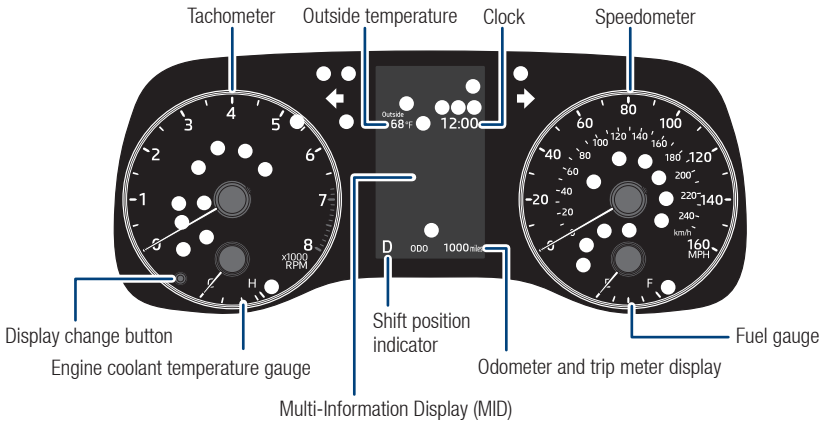

Vehicles equipped with 7-in display

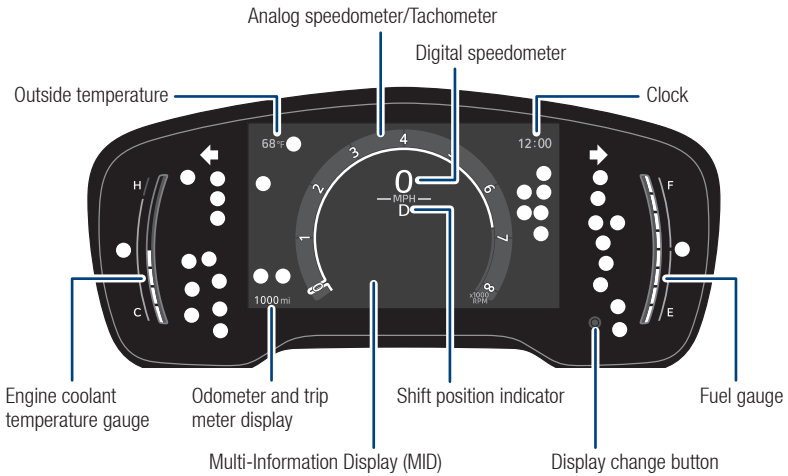

○ Service indicators and warning lights

Vehicles equipped with 4.2-in display

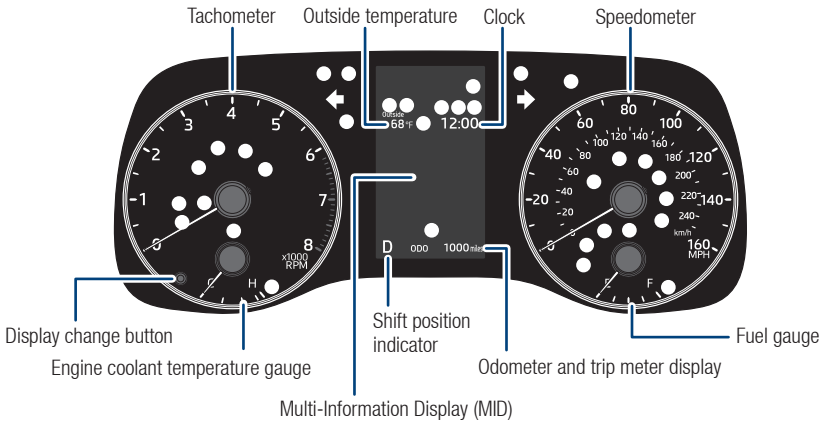

Vehicles equipped with 7-in display

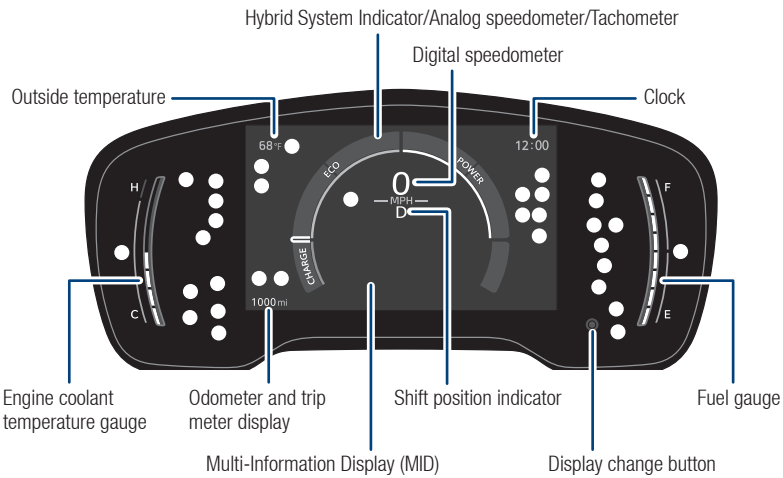















































○ Service indicators and warning lights

OVERVIEW

Indicator symbols

For details, refer to “Warning lights and indicators,” Section 2-1, 2024 “Owner’s Manual”.

	“AIR BAG ON/OFF” indicator ¹		Fog light indicator ⁴
	ABS (Anti-lock Brake System) warning ¹		Fuel tank door position
	AHB (Automatic High Beams) indicator		Full-Speed Range Dynamic Radar Cruise Control (DRCC) indicator ⁸ [white/green/yellow]
	Brake hold operating indicator ^{2,8}		Headlight low/high beam indicators
	Brake hold standby indicator		High coolant temperature warning ⁸
	Brake system warning ^{1,8}		Hybrid system overheat warning ^{7,8}
	Brake system warning [yellow] ¹		Inappropriate pedal operation warning ⁸
	BSM (Blind Spot Monitor) outside rear view mirror indicators ^{1,4}		Intuitive parking assist OFF indicator ^{4,8}
	Charging system warning ⁸		LDA (Lane Departure Alert) indicator ⁸ [white/green/yellow ³]
	Driver's and front passenger's seat belt reminder (alarm will sound when the vehicle is on)		LTA (Lane Tracing Assist) indicator ⁸ [white/green/yellow ³]
	Driving assist information indicator ¹		Low engine oil pressure warning ⁸
	Eco Driving Indicator light ^{1,6}		Low fuel level warning
	Eco drive mode indicator ⁷		Low outside temperature indicator
	Electric power steering system warning ^{1,8} [red/yellow]		Low tire pressure warning ^{1,8}
	EV drive mode indicator ⁷		Malfunction/Check Engine indicator ^{1,8}
	EV indicator ⁷		

	Parking brake indicator ²
	PCS (Pre-Collision System) warning ^{1,2,8} [yellow]
	PDA (Proactive Driving Assist) indicator ⁸ [white/green/yellow]
	“READY” indicator ⁷
	Rear passengers’ seat belt reminder ⁸ (4.2-in display)
	Rear passengers’ seat belt reminder ⁸ (7-in display)
	Security indicator
	Slip indicator ^{1,3}
	Smart Key system indicator ⁴
	Sport mode indicator ^{4,7}
	Stop & Start cancel indicator ^{1,2,6,8}
	Stop & Start indicator ⁶
	SRS airbag warning ¹
	Turn signal indicator
	VSC (Vehicle Stability Control) OFF indicator ¹

¹ If the indicator does not turn off within a few seconds of starting the vehicle, there may be a malfunction. Have the vehicle inspected by your Toyota dealer.

² If the indicator flashes or illuminates, there may be a malfunction. Refer to the “Owner’s Manual”.

³ If the indicator flashes, it indicates that the system is operating.

⁴ If equipped.

⁵ Refer to section PKSB (Parking Support Braking function) in the “Owner’s Manual”.

⁶ Corolla Cross only.

⁷ Corolla Cross Hybrid only.

⁸ With warning buzzer.

OVERVIEW

Keyless entry (if equipped)

UNLOCKING OPERATION

Smart Key

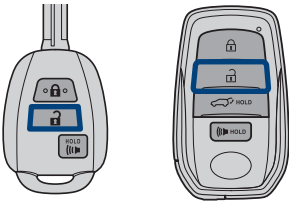

(Corolla Cross)



Press

ONCE: Driver door
TWICE: All doors

Carry Smart Key remote

Driver door unlock*
Grasp

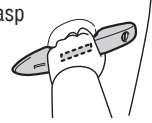

NOTE: If a door is not opened within 60 seconds of unlocking, all doors will relock for safety.

LOCKING OPERATION

Smart Key



(Corolla Cross)



Press

Carry Smart Key remote

All-door lock

Touch

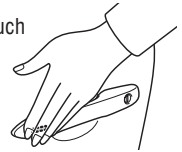

POWER LIFTGATE OPERATION (OPENING/LOCKING/UNLOCKING)*

Smart Key



Press and hold

* If equipped

Carry Smart Key remote

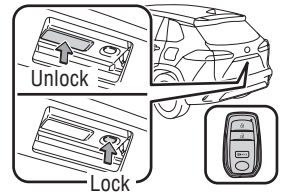

* Driver door unlocking function can be programmed to unlock driver door only, or all doors. In some models, grasping front passenger door handle will unlock all doors.

Please refer to the "Owner's Manual" for more details on how to program the doors.

NOTE: Vehicle with a Smart Key system - Doors may also be locked/unlocked using the mechanical key. (Slide the release lever on the back of Smart Key and take the mechanical key out.)

PANIC BUTTON

Smart Key



(Corolla Cross)



HOLD
Press and hold



Smart Key system (if equipped)

START FUNCTION

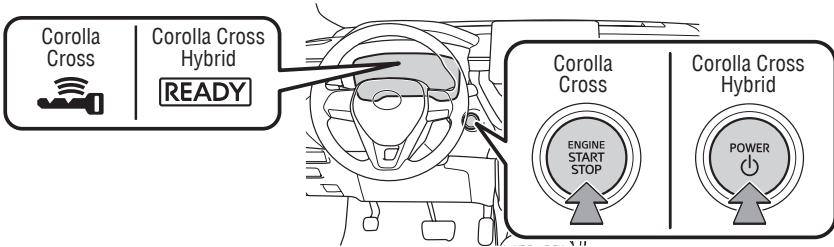

NOTE: The Smart Key must be carried to enable the start function. With the shift lever in Park and the brake pedal depressed, press the power button.

POWER (WITHOUT STARTING THE VEHICLE)

Without depressing the brake pedal, pressing the power button will change the operation mode in succession from:

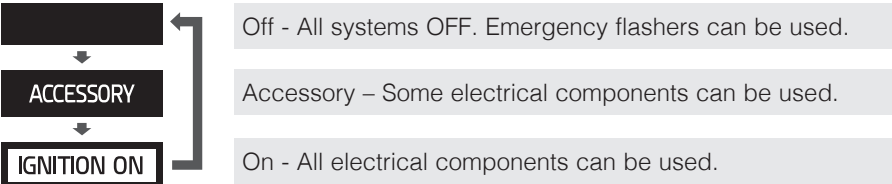

Instrument panel light control

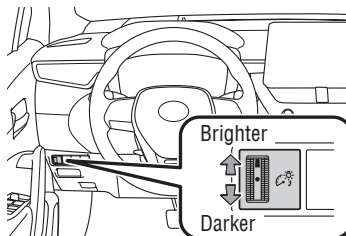

OVERVIEW

Fuel tank door release & cap

COROLLA CROSS

COROLLA CROSS HYBRID

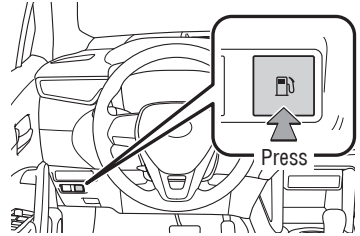
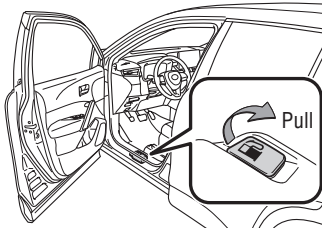

OPENING/CLOSING

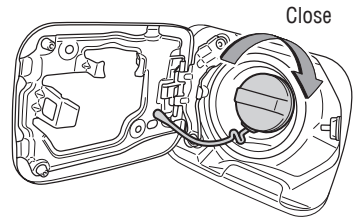
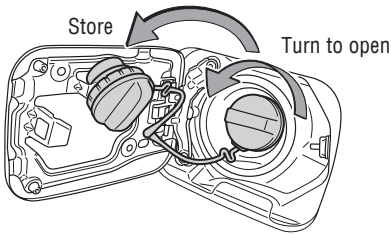

NOTE: Tighten until one click is heard. If the cap is not locked or tightened enough, the Check Engine indicator  may illuminate.

Hood release

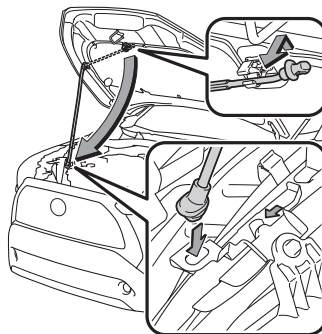
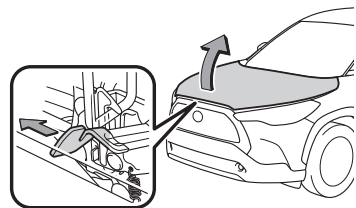
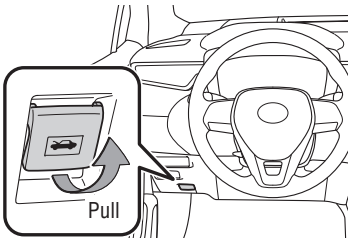

Engine maintenance

COROLLA CROSS

Engine coolant reservoir

Engine oil filler cap

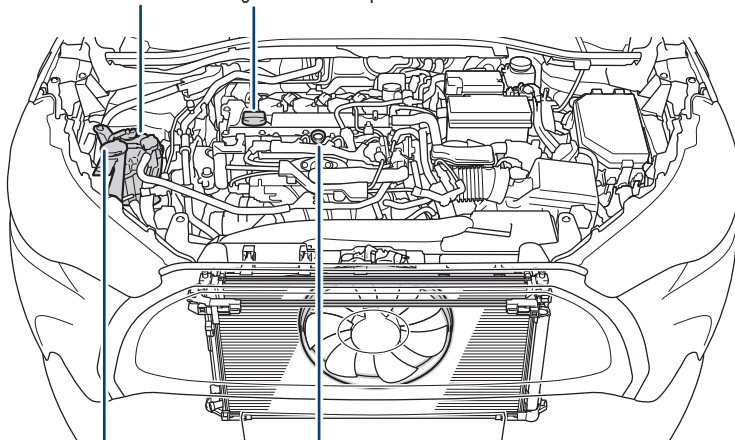

Washer fluid tank

Engine oil level dipstick

COROLLA CROSS HYBRID

Engine coolant reservoir

Engine oil filler cap

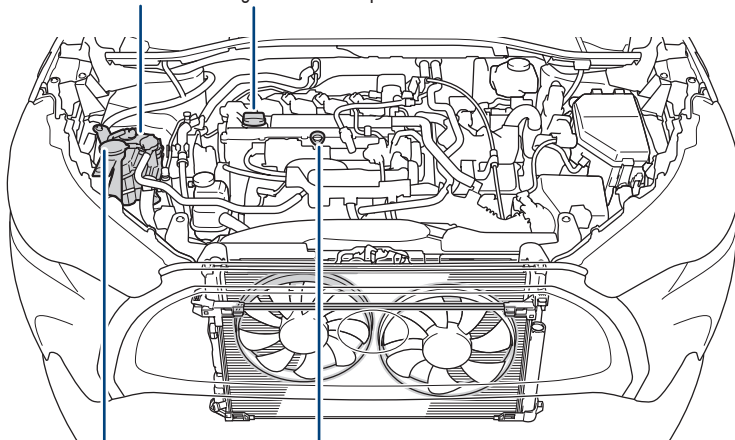

Washer fluid tank

Engine oil level dipstick

NOTE: Regularly scheduled maintenance at your Toyota dealer, including oil changes, will help extend the life of your vehicle and maintain performance. Please refer to the “Warranty & Maintenance Guide.”

FEATURES & OPERATIONS

Continuously variable transmission/ Hybrid transmission

VEHICLES EQUIPPED WITHOUT PADDLE SHIFTERS -
COROLLA CROSS / COROLLA CROSS HYBRID

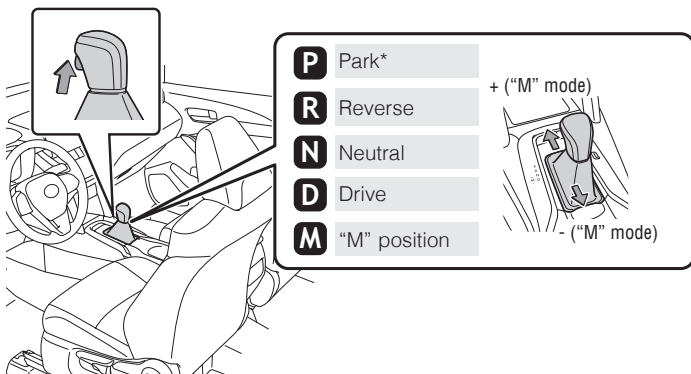

VEHICLES EQUIPPED WITH PADDLE SHIFTERS -
COROLLA CROSS HYBRID

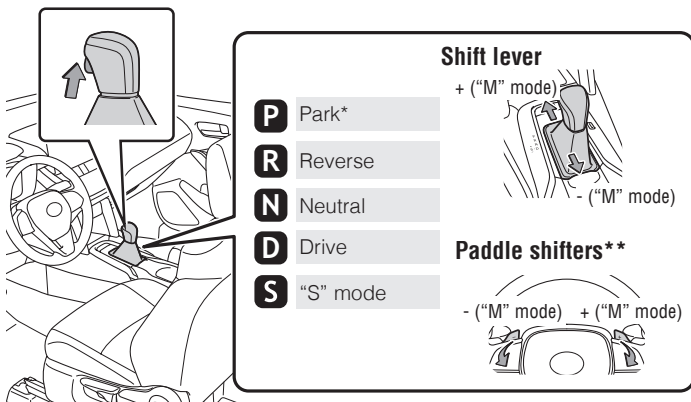

* The vehicle must be on and the brake pedal depressed to shift from Park.

** If equipped.

"M" 10-SPEED SPORT SEQUENTIAL SHIFTMATIC MODE*1 / S MODE*2

Shift the shift lever to "M"*1 position from "S"*2 position.

Shift lever type:

- + : Upshift (push and release)
- : Downshift (pull and release)

Paddle shifters type (if equipped):

- + : Upshift (pull and release)
- : Downshift (pull and release)

Downshifting increases power going uphill, or provides engine braking downhill. For best fuel economy during normal driving conditions, always drive with the shift lever in the "D" position.

*1: Corolla Cross

*2: Corolla Cross Hybrid

Refer to the "Owner's Manual" for more details.

Hybrid Synergy Drive System

The Hybrid Synergy Drive System utilizes a computer-controlled gasoline engine and electric motor to provide the most efficient combination of power for the vehicle. When the brakes are applied, the braking force generates electricity, which is then sent to the traction battery to conserve energy. In addition, the engine shuts off when the vehicle is stopped. The benefits are better fuel economy and reduced vehicle emissions.

NOTE: Fuel consumption and energy information of the Hybrid System are shown on the Multi-Information Display (MID) and the multimedia system screen.

TIPS FOR IMPROVED FUEL ECONOMY

- Ensure tire pressures are maintained at levels specified in the “Owner’s Manual”.
- When possible, link trips to reduce engine cold starts.
- Avoid driving at speeds that are higher than necessary, especially on the highway.
- When possible, avoid sudden stops to maximize regenerative braking energy.
- Minimize use of the air conditioning.

STARTING YOUR VEHICLE

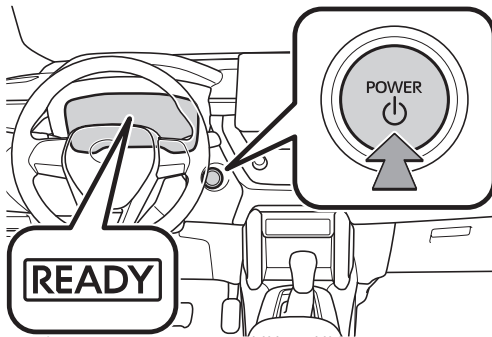

1. Put the shift lever in “P.”
2. Depress the brake pedal, and “” and a message will be displayed on the Multi-Information Display (MID).
3. Press the “POWER” button briefly and firmly.
4. Continue depressing the brake pedal until the “READY” indicator is illuminated. If the “READY” indicator turns on, the hybrid system will operate normally. Shift the lever to the desired position and you may begin driving.

FEATURES & OPERATIONS

Auto lock/unlock

Automatic door locks can be programmed to operate in different modes, or turned OFF.

DEFAULT SETTING

Shift position linked door locking/unlocking function

- Doors lock when shifting from Park.
- Doors unlock when shifting into Park.

CUSTOMIZED SETTING

Speed linked door locking function

- Doors lock when the vehicle speed is approximately 12 mph (20 km/h) or higher.

Driver's door linked door unlocking function

- Doors automatically unlock when the driver's door is opened.

Refer to the "Owner's Manual" or contact your Toyota dealer for more details.

Door lock switches

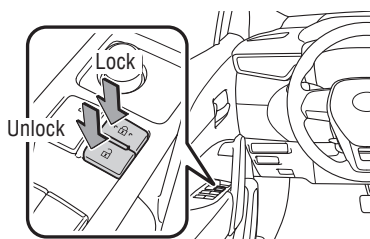

Power windows

Driver side

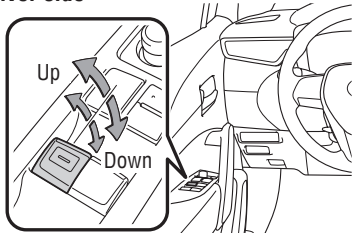

Window lock switch

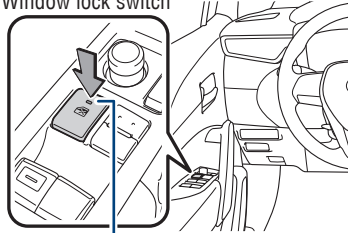

All window auto up/down

Push the switch completely down or pull it completely up and release to fully open or close. To stop the window partway, operate the switch in the opposite direction.

Window lock switch

Deactivates all passenger windows. Driver's window remains operable.

Steering lock release (if equipped)

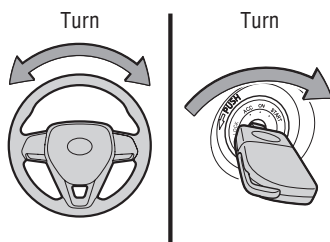

When starting the engine, the engine switch may seem stuck in OFF. To free it, turn the key while turning the steering wheel slightly left and right.

Tilt & telescopic steering wheel

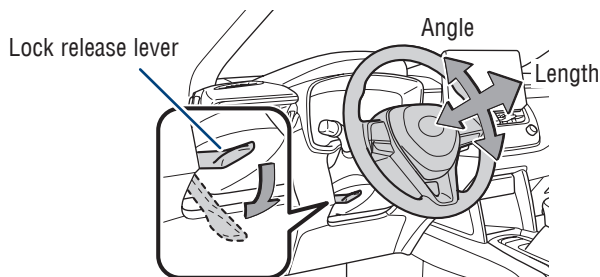

Hold the steering wheel, push the lever down, set angle and length, and return the lever.

NOTE: Do not attempt to adjust while the vehicle is in motion.

Moonroof (if equipped)

SLIDING OPERATION

Recommended open position to minimize wind noise.

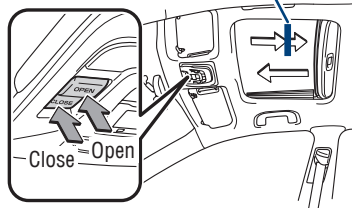

Press once to open partway.
Press again to open completely.

TILTING OPERATION

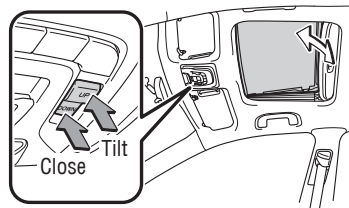

Press once to open completely.

Lightly press either side of the moonroof switch while opening/tilting is in progress, the moonroof stops partway.

FEATURES & OPERATIONS

Front seats-Adjustments

MANUAL SEAT

POWER SEAT (DRIVER SIDE ONLY)

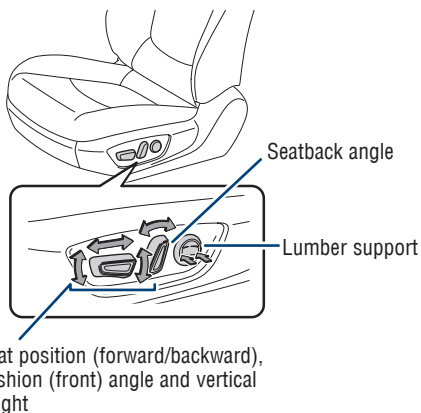
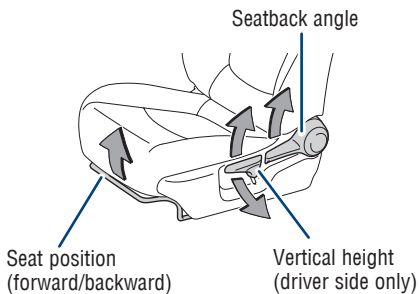

Rear seats-Folding

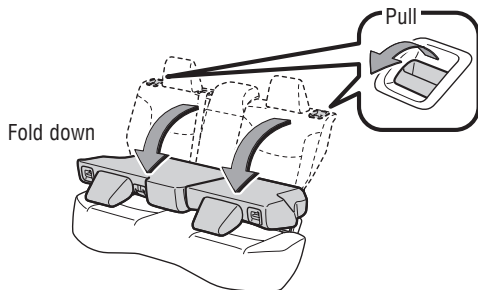

Seats-Head restraints

Front

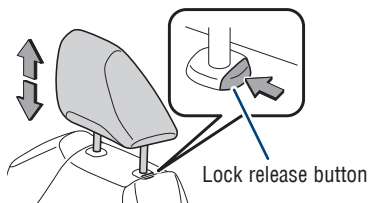

Rear outside

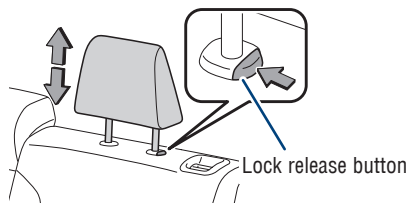

Rear door-Power Liftgate (if equipped)

OPENING/CLOSING POWER LIFTGATE

Instrument panel

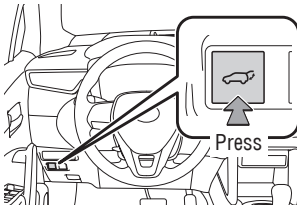

Open: Press and hold
Close: Press and hold again

Liftgate opener switch (open only)

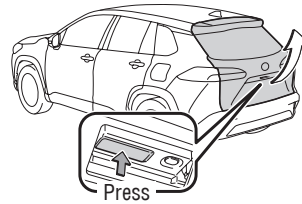

Power liftgate switch on the back door

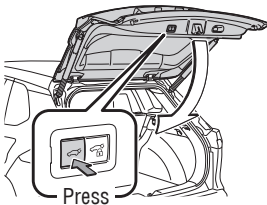

Lock switch on the back door

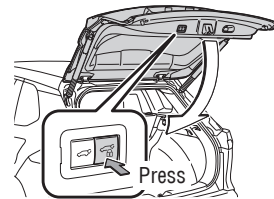

When the back door is closed, all of the doors will lock simultaneously and operation signals will indicate that all of the doors have been locked.

ADJUSTING THE POWER LIFTGATE HEIGHT

1. When the liftgate reaches the desired height, press the rear liftgate close-button (on the door jam of the liftgate) once. Press and hold the button until the buzzer sounds (4 times).
2. To reset the height, with the liftgate open and not moving, press and hold the rear liftgate close-button for approximately 7 seconds until the buzzer sounds 4 times, and continue to hold until it buzzes 2 times again, then let go. Press the same button to close the liftgate. When you open the liftgate next time, it will open to the maximum height.

For more details, refer to the "Owner's Manual".

Electric parking brake

PARKING BRAKE

Automatic mode ON

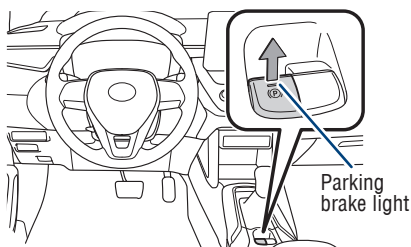

Automatic mode OFF

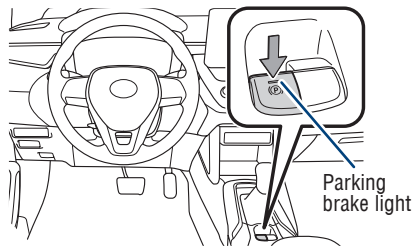

Manual mode

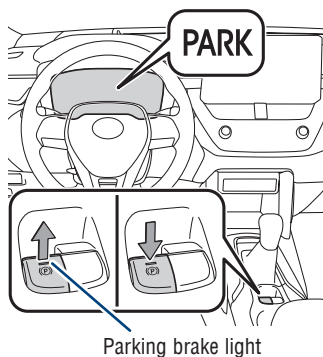

Automatic mode

To turn automatic mode ON, while vehicle is stopped, pull and hold the parking brake switch until a buzzer sounds and a message displays on the Multi-Information Display (MID). While depressing the brake pedal, shifting the lever into P position will automatically set the brake and turn the parking brake indicator light and parking brake light on. To release brake, depress the brake pedal and shift the lever out of P. The indicator and the light will turn off.

To turn automatic mode OFF, press and hold the parking brake switch until a buzzer sounds and a message displays on the MID.

Manual mode

While the vehicle is stopped and the brake pedal is depressed, pull the switch to set the parking brake and turn the parking brake indicator light and parking brake light on. To release, depress the brake pedal and press the switch. The indicator and the light will turn off.

Refer to the "Owner's Manual" for limitations and more details.

BRAKE HOLD

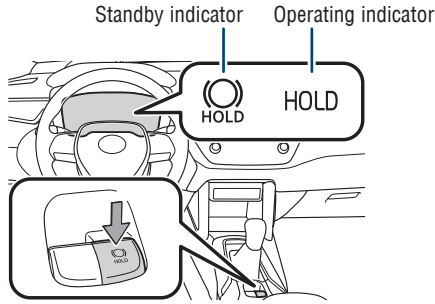

Brake hold

The brake hold system keeps the brake applied when the shift lever is in D, M*1/S*2 or N while the system is on and the brake pedal has been depressed to stop the vehicle. The system releases the brake when the accelerator pedal is depressed with the shift lever in D or M*1/S*2 to allow smooth start off.

*1: Corolla Cross

*2: Corolla Cross Hybrid

Refer to the "Owner's Manual" for more details.

Bottle holders

FRONT (DOOR MOUNTED)

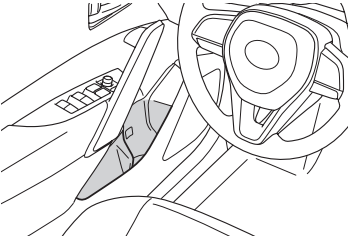

REAR (DOOR MOUNTED)

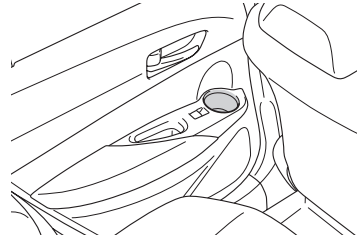

Cup holders

FRONT

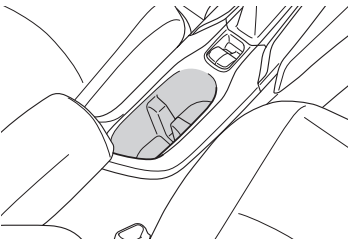

REAR (IF EQUIPPED)

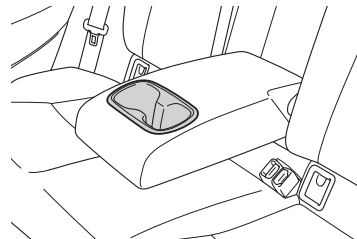

FEATURES & OPERATIONS

Multi-Information Display (MID)

VEHICLES EQUIPPED WITH
4.2-in DISPLAY

Driving support system status display area



Content display area

VEHICLES EQUIPPED WITH
7-in DISPLAY

Driving support system status display area

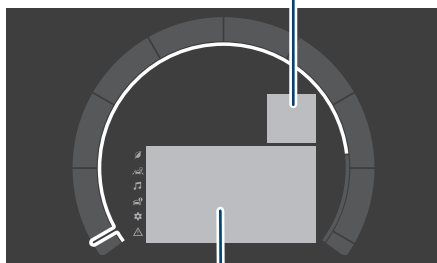

Content display area

Return to the previous screen

Press: Enter/Set
Press and hold: Reset

Scroll/search screens/
select menu icons

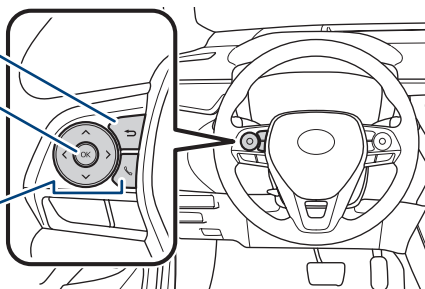

Press MID control switches to change and select information in the following:



Driving information display



Driving support system information display



Audio system-linked display (4.2-in display/7-in display)



Vehicle information display



Settings display (4.2-in display/7-in display)



Warning message display

Refer to the "Owner's Manual" for limitations and more details.

Steering wheel switches & telephone controls (Bluetooth®)

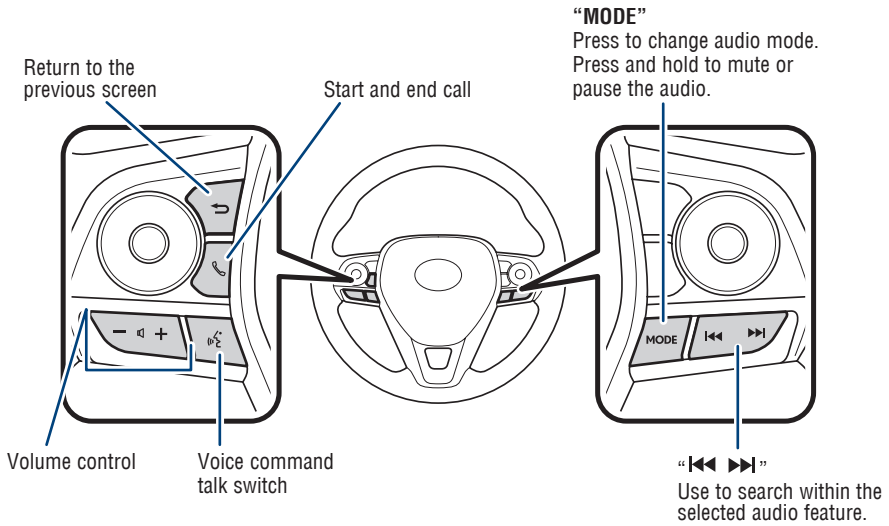

Bluetooth® technology allows dialing or receipt of calls without removing your hands from the steering wheel.

Refer to the Bluetooth® device pairing in this guide or the “Multimedia Owner’s Manual” for additional user instructions.

NOTE: Always use safe driving practices and follow all traffic rules.

Lights & turn signals

HEADLIGHTS

Operating the “☀️” switch turns on the headlight indicator 🚗.

Type A

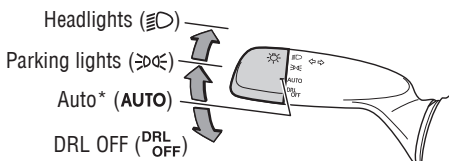

Type B

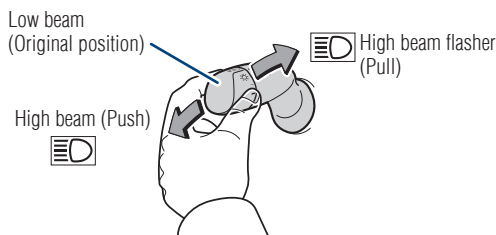
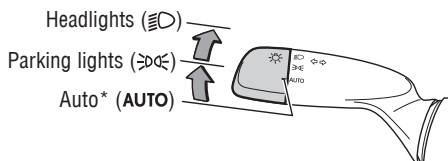

*: If equipped

Daytime Running Light system (DRL)

Automatically turns on under certain conditions to make vehicle more visible to other drivers. Not for use at night. (The parking brake needs to be released and the headlight switch must be in the “🚗” or “AUTO” position while the vehicle is on.)

Automatic light cut off system (AUTO)

- Headlights are on: The headlights and taillights will turn off automatically 30 seconds after the vehicle is turned from ON to ACC or OFF and the driver’s door is opened and closed. (If the “🔒” switch on the Smart Key remote is pressed after all doors are closed, the lights will turn off immediately.)
- Only the taillights are on: The taillights will turn off automatically if the vehicle is turned from ON to ACC or OFF and the driver’s door is opened.

Automatic High Beams system (AHB)**

Automatically switches between high and low beams as appropriate to enhance vision at night.

Refer to Toyota Safety Sense™ 3.0 in this guide or the “Owner’s Manual” for more details on the Automatic High Beams feature.

** Operating conditions must be met. Refer to the “Owner’s Manual” for details.

FRONT FOG LIGHTS (IF EQUIPPED)

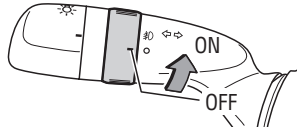

Front fog lights come on only when the headlights are on low beam.

TURN SIGNALS

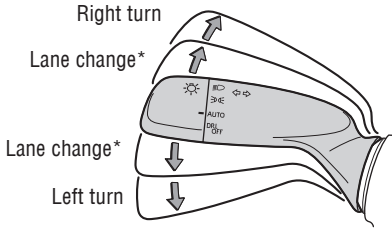
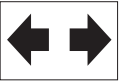

* Move the lever partway and release. The signals will flash three times.

Windshield wipers & washers

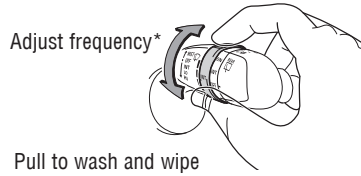
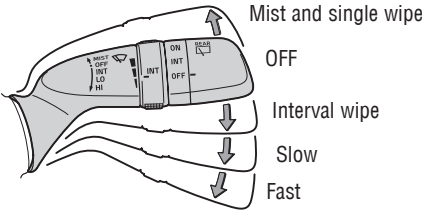

* **Intermittent windshield wiper frequency adjustment:** Rotate to increase/decrease wiper frequency. (Available on select grades.)

REAR (IF EQUIPPED)

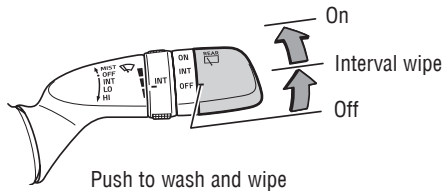

Refer to the "Owner's Manual" for more information.

Audio Multimedia

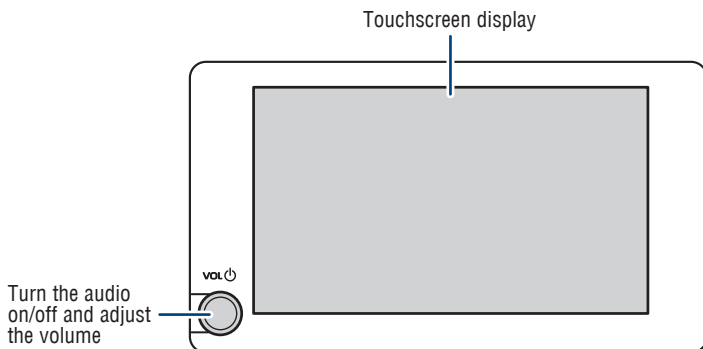

Refer to the "Multimedia Owner's Manual" or visit www.toyota.com/audio-multimedia for additional resources.

NOTE: Always use safe driving practices and follow all traffic rules.

Clock



- 1) Press "⚙️" on the main menu.
- 2) Select "General" on the submenu.
- 3) Select "Date & Time."
- 4) Select the desired items to be set.

NOTE: It is recommended to "Set date & time by GPS" feature to ON for automatic time updates based on your location.

Refer to the "Multimedia Owner's Manual" for more details.

Garage door opener (HomeLink®)*

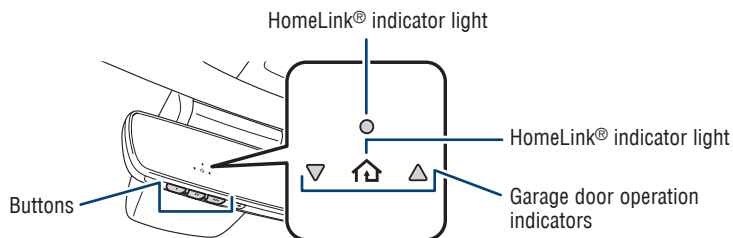

Garage door openers manufactured under license from HomeLink®* can be programmed to operate garage doors, estate gates, security lighting, etc.

Refer to the "Owner's Manual" for more details.

For programming assistance, contact HomeLink® at 1-800-355-3515, or visit www.homelink.com/toyota.



* HomeLink® is a registered trademark of Gentex Corporation.

FEATURES & OPERATIONS

Power outlet-12V DC

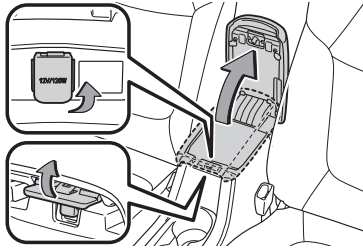

The vehicle must be in the “ACCESSORY” or “IGNITION ON” mode for use.

USB Type-C media port

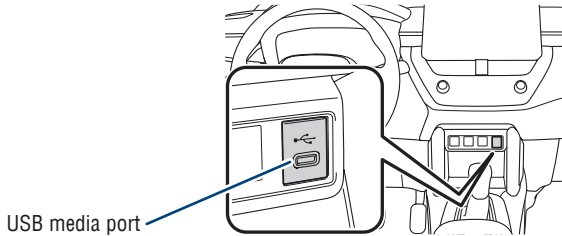

Connecting a compatible device and cable into the USB media port will support charging and music playback through the audio multimedia system.

USB Type-C charge ports (if equipped)

FRONT (IF EQUIPPED)

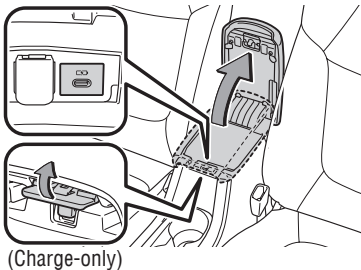

REAR (IF EQUIPPED)

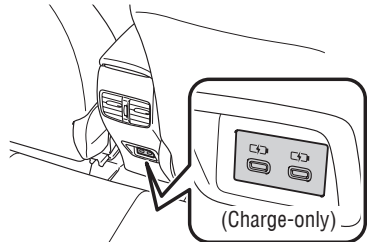

The vehicle must be in the “ACCESSORY” or “IGNITION ON” mode for use.

Qi Wireless charger (if equipped)

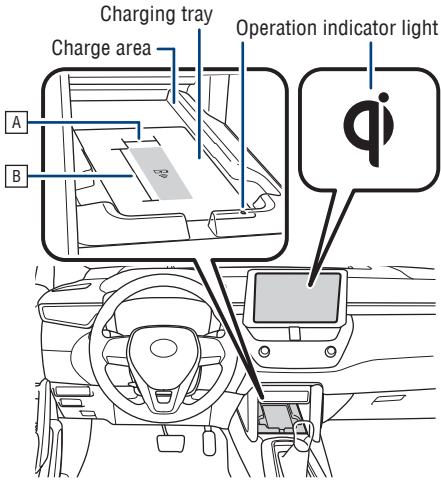

- A Approximately 1.0 in. (2.5 cm)
- B Approximately 3.9 in. (10 cm)

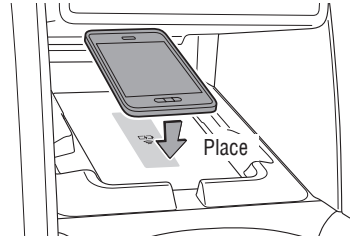

Place device nearest in the center of the charging area for best results. If the charging coil is not in the center of the device, place the device so that its charging coil is centered in the charging area.

A mobile device can be charged wirelessly on the tray. Place a compatible mobile device on the tray as shown in the illustration. An amber indicator illuminates while charging is in progress. When charging is complete, the indicator illuminates green. Some phones, cases or cover type wireless chargers may not cause the green indicator to illuminate even though it is fully charged.

The vehicle must be in the “ACCESSORY” or “IGNITION ON” mode for use.

Refer to the “Owner’s Manual” for limitations and more details on this system before attempting to use it.

Heated seats (if equipped)

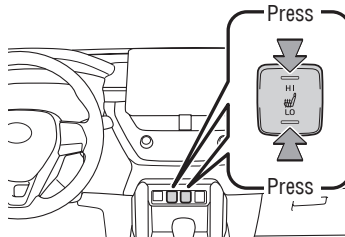

The vehicle must be on for use.

FEATURES & OPERATIONS

Air conditioning/heating

AUTOMATIC AIR CONDITIONING -
COROLLA CROSS* / COROLLA CROSS HYBRID

* If equipped.

Without DUAL mode air conditioning system

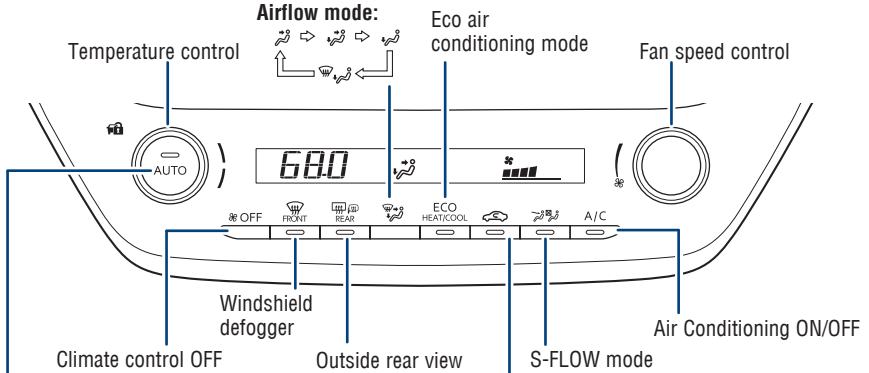

Automatic mode:

Adjusting the temperature setting will cause the airflow mode, air intake and fan speed to adjust automatically to the set temperature.

With DUAL mode air conditioning system

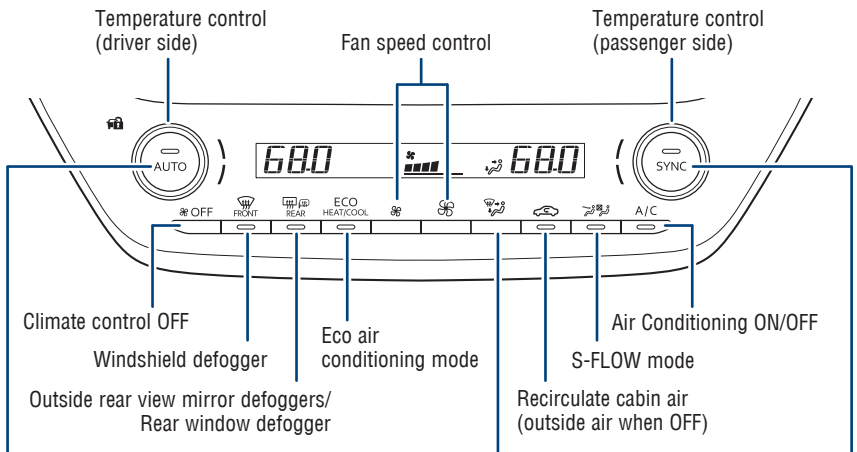

Automatic mode:

Adjusting the temperature setting will cause the airflow mode, air intake and fan speed to adjust automatically to the set temperature.

Airflow mode:



“SYNC” mode:

Adjusting the temperature for driver's and front passenger's seats separately.

MANUAL AIR CONDITIONING (IF EQUIPPED) - COROLLA CROSS

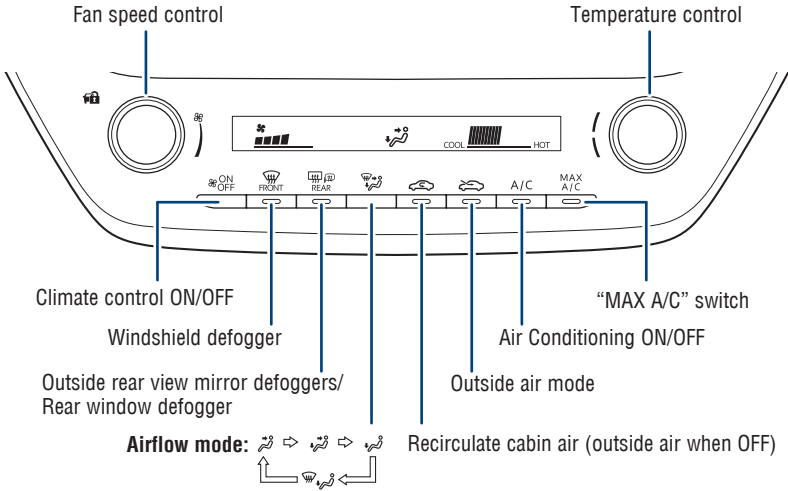

FEATURES & OPERATIONS

Stop & Start Engine System (Corolla Cross only*)

* Not applicable to Corolla Cross Hybrid.

The Stop & Start Engine System stops and starts the engine according to brake pedal or shift lever operation when the vehicle is stopped, such as at a stoplight, intersection, etc., in order to improve fuel economy and reduce noise pollution caused by the engine idling.

STOP & START ENGINE SYSTEM OPERATION

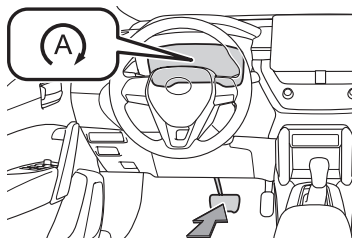

Stopping the engine

While driving with the D shift position selected, depress the brake pedal and stop the vehicle. The engine will stop automatically.

When the engine stops, the Stop & Start indicator will illuminate.

Restarting the engine

Release the brake pedal. The engine will start automatically.

When the engine starts, the Stop & Start indicator will turn off.

DISABLING THE STOP & START SYSTEM

Press the Stop & Start Engine System cancel switch to disable the Stop & Start Engine System. The Stop & Start cancel indicator will illuminate. Pressing the switch again will enable the Stop & Start Engine System and the Stop & Start cancel indicator will turn off.

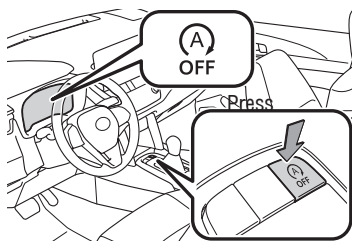

HILL-START ASSIST CONTROL (HAC)

If the engine is stopped by the Stop & Start Engine System when the vehicle is on an incline, brake force is temporarily maintained to prevent rolling backwards until the engine is restarted and drive force is generated.

When drive force is generated, the maintained brake force is automatically canceled.

Refer to the "Owner's Manual" for limitations and more details on this system before attempting to use it.

Driving mode select switch (Corolla Cross Hybrid only*)

* Not applicable to Corolla Cross.

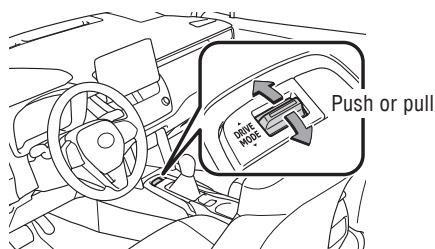

Normal mode

Suitable for normal driving.

Sport mode

Use Sport mode when increased acceleration response and precise handling is desired, for example, when driving on roads with many curves.

ECO drive mode

Helps the driver accelerate in an eco-friendly manner and improve fuel economy through moderate throttle characteristics and by controlling the operation of the air conditioning system (heating/cooling).

Refer to the "Owner's Manual" for limitations and more details on this system.

EV drive mode (Corolla Cross Hybrid only*)

* Not applicable to Corolla Cross.

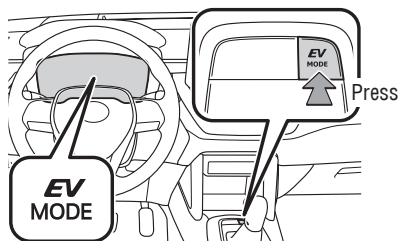

Use EV drive mode when driving short distances to reduce noise early in the morning and late at night in residential areas or to cut emissions when parking in a small garage or indoor car park.

Refer to the "Owner's Manual" for limitations and more details on this system.

FEATURES & OPERATIONS

Rear view monitor system

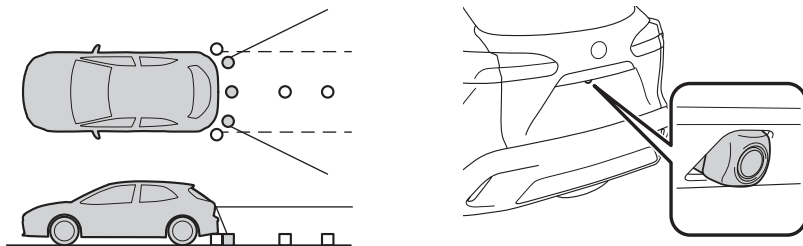

The rear view monitor system displays an image of the view from the bumper of the rear area of the vehicle. The camera for the rear view monitor system is located above the license plate.

To adjust the image on the rear view monitor screen, press “” on the main menu on the Multimedia display and select “Display.” Select “Camera” to adjust the screen contrast and brightness.

Refer to the “Multimedia Owner’s Manual” for limitations and more details on this system.

Vehicle Stability Control (VSC)/ TRAC OFF switch

COROLLA CROSS

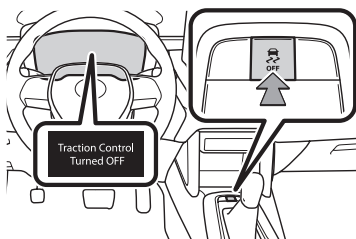

COROLLA CROSS HYBRID

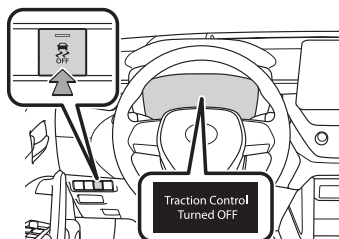

The VSC OFF switch can be used to help free a stuck vehicle in surroundings like mud, dirt or snow. While the vehicle is stopped, press the switch to disable the TRAC system.

To disable both VSC and TRAC systems, press and hold the switch for at least 3 seconds while the vehicle is stopped.

Refer to the “Owner’s Manual” for limitations and more details.

Intuitive Parking Assist (if equipped)

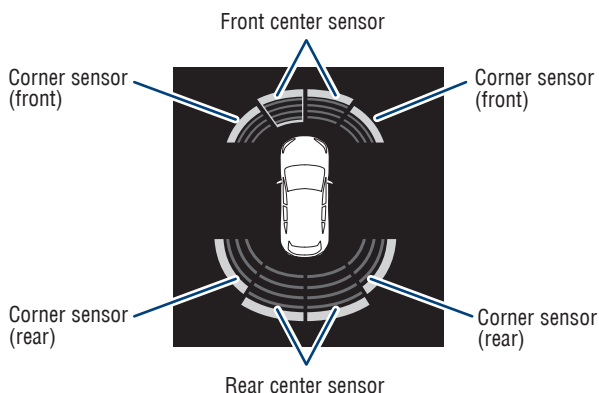

The parking assist sonar system operates when the vehicle approaches an obstacle. The distance from your vehicle to nearby obstacles when parallel parking or maneuvering into a garage is measured by sensors and communicated via the Multi-Information Display (MID) and/or the multimedia display and a buzzer.

When the sensor detects an obstacle, the direction and the approximate distance to the obstacle are displayed on the MID and/or the multimedia display by illuminating continuously (far) or blinking (near), and beeping sounds will switch from intermittent to continuous as you approach and get closer to a detected obstacle. When the sensors detect two or more obstacles, the audible alerts will respond to the nearest zone.

Always check the surrounding area when using this system.

SYSTEM ON/OFF

- (1) Press “<>” or “◊” switches and select “⚙️ (4.2-in display)” or “⚙️ (7-in display)” from the Multi-Information Display (MID).
- (2) Press “<>” or “◊” switches and select “P📏 Parking Assist” and then press “OK” to turn the system On/Off.
- (3) Press “↩️” to go back to the menu.

Refer to the “Owner’s Manual” for limitations and more details.

FEATURES & OPERATIONS

Blind Spot Monitor (BSM) and Rear Cross Traffic Alert (RCTA) (if equipped)

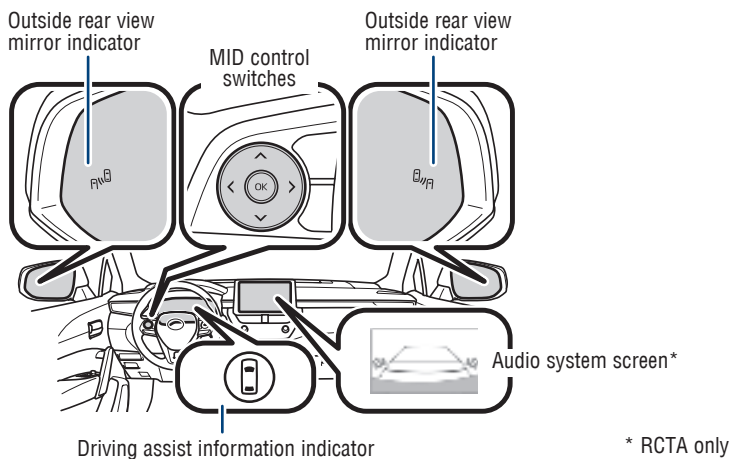

BLIND SPOT MONITOR (BSM)

The system is designed to use radar sensors to detect vehicles traveling in the Corolla Cross's blind spot. If a vehicle is detected, the driver will be alerted via the outside rear view mirror indicator on the detected side.

REAR CROSS TRAFFIC ALERT (RCTA)

While in reverse, when a vehicle approaching from the right or left rear of the Corolla Cross is detected, the outside rear view mirror indicators will flash and a buzzer will sound. Also, the RCTA icon for the detected side will be displayed on the audio system screen.

SYSTEM ON/OFF

- (1) Press “<>” or “◇” switches and select “⚙️ (4.2-in display)” or “⚙️ (7-in display)” from the Multi-Information Display (MID).
- (2) Press “<>” or “◇” switches and select “🚗 BSM” or “🚗 RCTA” and then press “OK” to turn BSM or RCTA On/Off.
- (3) Press “↩️” to go back to the menu.

Refer to the “Owner’s Manual” for limitations and more details on this system before attempting to use it.

Safe Exit Assist (SEA) (if equipped)

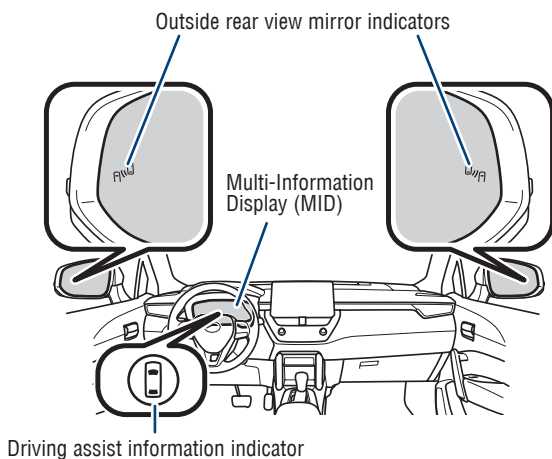

Safe Exit Assist is a system that uses rear side radar sensors installed on the inner side of the rear bumper to help warn occupants if an approaching vehicle or bicycle may collide with an opened door, before or as the door is being opened, to reduce the possibility of a collision.

SYSTEM ON/OFF

- (1) Press “<>” or “◊” switches and select “⚙️ (4.2-in display)” or “⚙️ (7-in display)” from the Multi-Information Display (MID).
- (2) Press “<>” or “◊” switches and select “🚪 SEA” or “🚪 Safe Exit Assist” and then press “Ⓞ” to turn the system On/Off.
- (3) Press “↩️” to go back to the menu.

Refer to the “Owner’s Manual” for limitations and more details on this system before attempting to use it.

FEATURES & OPERATIONS

Front and Rear Parking Assist with Automatic Braking (PA w/AB) (if equipped)

Front and Rear Parking Assist with Automatic Braking consists of the following functions that operate when driving at a low speed or backing up, such as when parking. When the system determines that the possibility of a collision with a detected object is high, a warning operates to urge the driver to take evasive action. If the system determines that the possibility of a collision with a detected object is extremely high, the brakes are automatically applied to help avoid the collision or help reduce the impact of the collision.

FUNCTIONALITY

For static objects front and rear

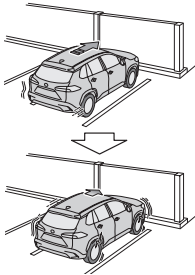

When traveling at a low speed and the brake pedal is not depressed, or is depressed late.

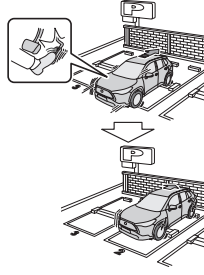

When the accelerator pedal is depressed excessively.

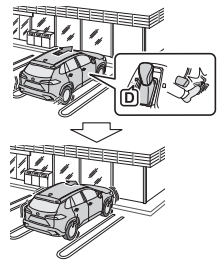

When the vehicle moves in the unintended direction due to the wrong shift lever position.

Moving vehicles rear of the vehicle



When reversing, a vehicle is approaching and the brake pedal is not depressed, or is depressed late.

SYSTEM ON/OFF

- (1) Press “<>” or “◊” switches and select “⚙️ (4.2-in display)” or “⚙️ (7-in display)” from the Multi-Information Display (MID).
- (2) Press “<>” or “◊” switches and select “🚗 PKSB” and then press “OK” to turn the system On/Off.
- (3) Press “↩️” to go back to the menu.

Refer to all of the section “Parking Support Brake function” in the “Owner’s Manual” for limitations and more details.



Quick overview-Toyota Safety Sense™ 3.0

Toyota Safety Sense™ (TSS) 3.0 is a suite of safety and driver assistance technologies designed to support driver awareness, decision making, and vehicle operation. TSS includes features such as Pre-Collision System with Pedestrian Detection, Lane Departure Alert with Steering Assist, and Dynamic Radar Cruise Control.

Refer to the Owner's Manual for details including system operation, limitations, and setting adjustments.

For more information, please visit www.toyota.com/safety-sense.



Pre-Collision System with Pedestrian Detection (PCS w/PD)

PCS w/PD is designed to provide alert, mitigation, and/or avoidance support in certain conditions, when the system determines there is potential for a collision with a detected object.

The advanced front radar system is designed to work with the forward-facing camera to help recognize a preceding vehicle, bicyclist, pedestrian or motorcyclist in certain conditions.



Lane Tracing Assist (LTA)

When driving on a road with clear lane lines with the dynamic radar cruise control operating, Lane Tracing Assist detects the lane lines and preceding and surrounding vehicles using the front camera and radar sensor, and operates the steering wheel to maintain the vehicle's lane position. LTA requires the driver to grip the steering wheel.

When LTA is activated, if the system does not detect driving operations, such as if the driver is not holding the steering wheel, and determines the driver is not responsive, the Emergency Driving Stop System (EDSS) is designed to decelerate the vehicle to a stop within its current lane to help avoid or mitigate a possible collision.



Lane Departure Alert (LDA) with Steering Assist

LDA uses the front camera to detect lane lines or certain other roadway boundaries. This system warns the driver if the vehicle may deviate from the current lane or course and also can slightly operate the steering wheel to help avoid deviation from the lane or course. If LDA detects that the vehicle is swaying, a message will be displayed and a warning buzzer will sound to urge the driver to take a break.



Full-Speed Range Dynamic Radar Cruise Control (DRCC)

Full-Speed Range DRCC is designed to help maintain a pre-set distance to a preceding vehicle when the preceding vehicle is traveling at a lower speed.



Automatic High Beams (AHB)

AHB is designed to detect the headlights of oncoming vehicles and the taillights of preceding vehicles and switch between high beams and low beams as appropriate.

TOYOTA SAFETY SENSE™



Road Sign Assist (RSA)

RSA is designed to recognize specific road signs using the forward-facing camera to provide information to the driver via the display.



Proactive Driving Assist (PDA)

When system operating conditions are met, using the vehicle's camera and radar, Proactive Driving Assist (PDA) provides gentle braking into curves or gentle braking and/or steering to help control distance between your vehicle and a preceding vehicle, pedestrian or bicyclist.

Over-The-Air (OTA) Updates

TSS 3.0 is capable of over-the-air updates. To use this function it is necessary to opt-in to the Connected Service Master Data Consent. In some instances when software is updated, the operating methods or functions may change. Before using the system, make sure to read the Digital Owner's Manual corresponding to the current software version, available at www.toyota.com/owners/resources/warranty-owners-manuals.

Sensors

TSS 3.0 combines a forward-facing camera mounted in front of the inside rear view mirror and a grille-mounted radar mounted in the front grille. These sensors support the driving assist systems.

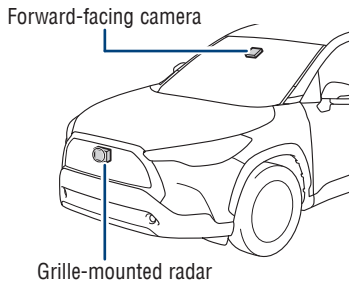

Pre-Collision System with Pedestrian Detection (PCS w/PD)

The Pre-Collision System with Pedestrian Detection (PCS w/PD) is designed to help detect a vehicle, bicyclist, pedestrian or motorcyclist in certain situations. Using both a camera and front radar, PCS w/ PD can provide an audio/visual alert to warn you of a possible collision under certain circumstances. If you don't react, the system is designed to automatically brake.

As there is a limit to the degree of recognition accuracy and control performance that this system can provide, do not overly rely on this system. This system will not prevent collisions or lessen collision damage or injury in every situation. Do not use PCS instead of normal braking operations under any circumstances. Do not attempt to test the operation of the Pre-Collision System yourself, as the system may not operate or engage, possibly leading to an accident. In some situations, such as when driving in inclement weather such as heavy rain, fog, snow or a sandstorm or while driving on a curve and for a few seconds after driving on a curve, a vehicle, bicyclist, pedestrian or motorcyclist may not be detected by the radar and camera sensors, preventing the system from operating or engaging properly.

Refer to the Toyota "Owner's Manual" for a list of additional situations in which the system operation may be limited.

Pre-Collision Warning

When the system determines that the possibility of a frontal collision is high, a buzzer will sound and an icon and warning message will be displayed on the Multi-Information Display (MID) to urge the driver to take evasive action.

Pre-Collision Brake Assist

If the driver notices the hazard and brakes, the system may provide additional braking force using Brake Assist. This system may prime the brakes and may apply greater braking force in relation to how strongly the brake pedal is depressed.

Pre-Collision Brake Control

If the driver does not brake in a set time and the system determines that the possibility of a collision with a preceding vehicle is extremely high, the system may automatically apply the brakes, reducing speed in order to help the driver reduce the impact and in certain cases avoid the collision.

See www.toyota.com/safety-sense for more information.

TOYOTA SAFETY SENSE™

PCS PEDESTRIAN DETECTION

Under certain conditions, the PCS included with TSS 3.0 may also help to detect a pedestrian, bicyclist or motorcyclist in front of your vehicle using the forward-facing camera and the front radar sensor. The forward-facing camera of PCS detects a potential pedestrian, bicyclist or motorcyclist based on size, profile, and motion of the detected pedestrian, bicyclist or motorcyclist. However, a pedestrian, bicyclist or motorcyclist may not be detected depending on the conditions, including the surrounding brightness and the motion, posture, size, and angle of the potential detected pedestrian, bicyclist or motorcyclist, preventing the system from operating or engaging.

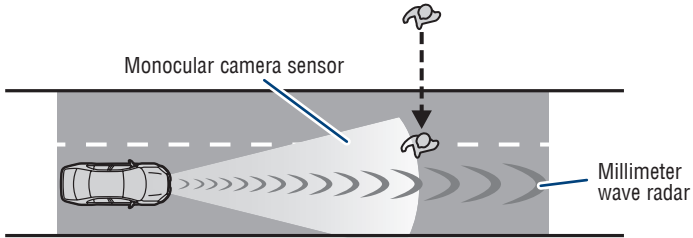

As part of the Pre-Collision System, this function is also designed to first provide an alert and then automatic braking if needed.

Refer to the Toyota “Owner’s Manual” for additional limitations and information.

CHANGING PCS WARNING TIMING

- (1) Press “<>” or “⬠” switches and select “⚙️ (4.2-in display)” or “⚙️ (7-in display)” from the Multi-Information Display (MID).
- (2) Press “<>” or “⬠” switches and select “🚗 PCS” and then press and hold “OK.” The setting screen is displayed.
- (3) Press “<>” or “⬠” switches and select “Warning timing” and then press “OK” to change the desired setting. Each time it is pressed, the PCS warning timing changes “Later” or “Default” or “Earlier.”
- (4) Press “➡️” to go back to the menu.

Note: PCS is enabled each time the vehicle is turned on. The system can be disabled/enabled and the alert timing of the system can be changed. (Alert timing only, brake operation remains the same.)

DISABLING PRE-COLLISION SYSTEM (PCS)

- (1) Press “<>” or “◊” switches and select “⚙️ (4.2-in display)” or “⚙️ (7-in display)” from the Multi-Information Display (MID).
- (2) Press “<>” or “◊” switches and select “🚗 PCS” and then press and hold “OK.” The setting screen is displayed.
- (3) Press “<>” or “◊” switches and select “🚗 PCS” and then press “OK” to turn PCS On/Off.
- (4) Press “↩️” to go back to the menu.

Refer to the Toyota “Owner’s Manual” for additional information on PCS w/PD operation, settings adjustments, limitations, and precautions before attempting to use it.









Lane Tracing Assist (LTA)

When driving on a road with clear lane lines with the dynamic radar cruise control operating, Lane Tracing Assist detects the lane lines and preceding and surrounding vehicles using the front camera and radar sensor, and operates the steering wheel to maintain the vehicle's lane position. LTA requires the driver to grip the steering wheel.

When LTA is activated, if the system does not detect driving operations, such as if the driver is not holding the steering wheel, and determines the driver is not responsive, the Emergency Driving Stop System (EDSS) is designed to decelerate the vehicle to a stop within its current lane to help avoid or mitigate a possible collision.

See www.toyota.com/safety-sense for more information.

Operation of the Lane Tracing Assist function is indicated by the following icons on the instrument cluster.

Indicator	Lane display	Steering icon	Situation
 White	 Gray/White	 Gray	LTA is on standby
 Green	 Green	 Green	LTA is operating
 Yellow Flashing	 Yellow Flashing	 Green	The vehicle is departing the lane toward the side which the lane display is flashing

Refer to the Toyota "Owner's Manual" for additional information on LTA operation, settings adjustments, limitations, and precautions before attempting to use it.

TURNING LANE TRACING ASSIST (LTA) ON/OFF

Press the LTA switch to turn LTA ON/OFF.

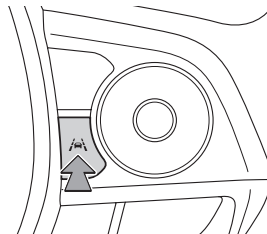

Note: Operation of LTA and setting adjustments continues in the same condition regardless of power switch modes until changed by the driver or the system is reset. The LTA indicator is illuminated when LTA is on.

Lane Departure Alert (LDA) with Steering Assist

LANE DEPARTURE ALERT (LDA) WITH STEERING ASSIST

By detecting visible lane markings or the road's edge at speeds above 30 mph, Lane Departure Alert (LDA) with Steering Assist is designed to issue a visual alert and audio or steering vibration alert if an inadvertent lane departure is detected. If the driver does not take corrective action, the Steering Assist function is designed to provide gentle corrective steering.* If LDA detects that the vehicle is swaying, a message will be displayed and a warning buzzer will sound to urge the driver to take a break.

* See www.toyota.com/safety-sense for more information and limitations.

Lane departure alert function

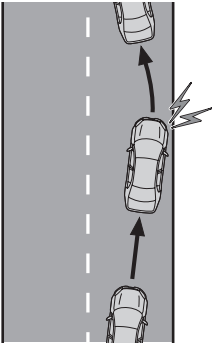

Lane departure prevention function

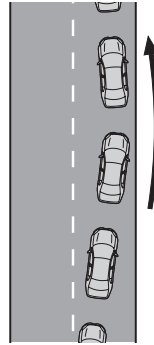



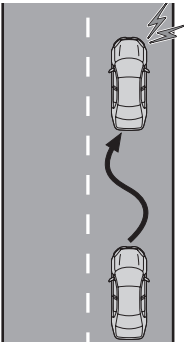









Break suggestion function (Sway Warning)









TOYOTA SAFETY SENSE™

LANE DEPARTURE ALERT (LDA) WITH STEERING ASSIST (CONTINUED)







Operation of the Lane Departure Alert function is indicated by the following icons on the instrument cluster.

Indicator	Lane display	Steering icon	Operation
Not illuminated	Not illuminated	Not illuminated	System disabled
 White	 Gray	Not illuminated	Lane lines are not detected by the system
 White	 White	Not illuminated	Lane lines are detected by the system
 Yellow Flashing	 Yellow Flashing	Not illuminated	Lane departure alert function is operating for the side which the lane display is flashing
 Green	 Green	 Green	Lane departure prevention function is operating for the side which the lane display is illuminated
 Yellow Flashing	 Yellow Flashing	 Green	Lane departure alert function/lane departure prevention function is operating for the side which the lane display is flashing







TURNING LDA ON/OFF

- (1) Press “<>” or “◊” switches and select “ (4.2-in display)” or “ (7-in display)” from the Multi-Information Display (MID).
- (2) Press “<>” or “◊” switches and select “ LDA” or “ Lane Departure Alert System” and then press and hold “OK.” The setting screen is displayed.
- (3) Press “<>” or “◊” switches and select “ LDA” or “ Lane Departure Alert System” and then press “OK” to turn LDA On/Off.
- (4) Press “↩” to go back to the menu.







ADJUSTING LDA ALERT TIMING

- (1) Press “<>” or “↕” switches and select “ (4.2-in display)” or “ (7-in display)” from the Multi-Information Display (MID).
- (2) Press “<>” or “↕” switches and select “ LDA” or “ Lane Departure Alert System” and then press and hold “.
 The setting screen is displayed.
- (3) Press “<>” or “↕” switches and select “Alert Timing” and then press “.
 to change the desired setting. Each time it is pressed, the LDA alert timing changes “Default” or “Earlier.”
- (4) Press “↩” to go back to the menu.

ADJUSTING LDA ALERT OPTIONS

- (1) Press “<>” or “↕” switches and select “ (4.2-in display)” or “ (7-in display)” from the Multi-Information Display (MID).
- (2) Press “<>” or “↕” switches and select “ LDA” or “ Lane Departure Alert System” and then press and hold “.
 The setting screen is displayed.
- (3) Press “<>” or “↕” switches and select “Alert Options” and then press “.
 to change the desired setting. Each time it is pressed, the LDA alert options changes “Vibration” or “Beep.”
- (4) Press “↩” to go back to the menu.

TURNING THE DRIVER BREAK SUGGESTION (SWAY WARNING) ON/OFF

- (1) Press “<>” or “↕” switches and select “ (4.2-in display)” or “ (7-in display)” from the Multi-Information Display (MID).
- (2) Press “<>” or “↕” switches and select “ Vehicle Settings” and then press and hold “.
 The setting screen is displayed.
- (3) Press “<>” or “↕” switches and select “ Driver Break Suggestion” and then press “.
 to turn the system On/Off.
- (4) Press “↩” to go back to the menu.

Refer to the Toyota “Owner’s Manual” for additional information on LDA operation, settings adjustments, limitations, and precautions before attempting to use it.

Full-Speed Range Dynamic Radar Cruise Control (DRCC)

Intended for highway use, Full-Speed Range Dynamic Radar Cruise Control (DRCC) let's you drive at a preset speed, with a minimum set speed of approximately 20 mph. The system uses vehicle-to-vehicle distance control, helping maintain a preset distance from the vehicle ahead of you.*

* See www.toyota.com/safety-sense for more information

Refer to the Toyota "Owner's Manual" for a list of additional situations in which the system operation may be limited.

Meter display

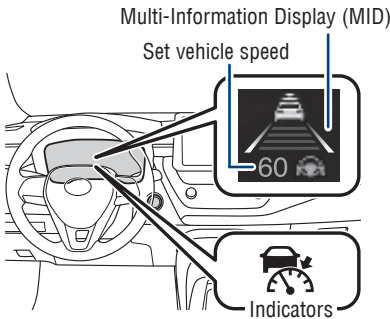

Switches

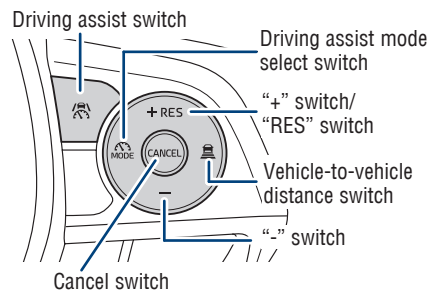

ACTIVATING DRCC

(1)

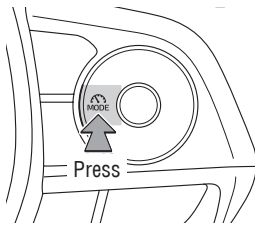

(2)

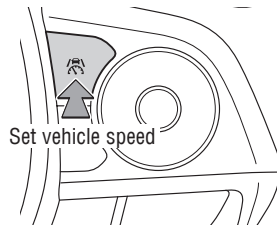



The vehicle will cruise at a set vehicle speed, decelerate to maintain a selected distance from a slower preceding vehicle and accelerate back up to the selected speed if the vehicle in front changes lanes or speeds up.

- (1) Press "MODE" switch to select DRCC. The dynamic radar cruise control indicator  will illuminate and the message "Adaptive Cruise Mode" will be displayed on the MID.
- (2) Using the accelerator pedal, accelerate or decelerate to the desired vehicle speed (approximately 20 mph [30 km/h] or more), and press "+RES" switch to set the set vehicle speed. The set vehicle speed will be displayed on the Multi-Information Display (MID).

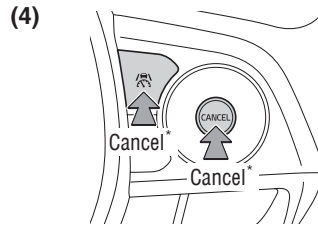
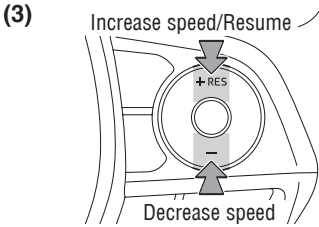
ADJUSTING SET VEHICLE SPEED



(3) To change the set vehicle speed, press the “+” (increase) or “-” (decrease) switch until the desired speed is displayed. Press and hold to continuously adjust the speed in 1 mph (1.6 km/h) increments, or use a single press to adjust in individual increments of 1 mph (1.6 km/h).

(4) Press “” switch or “” switch to cancel the speed control.
(Press the “” switch to resume control.)

* The speed control may also be canceled by depressing the brake pedal.

ADJUSTING DISTANCE

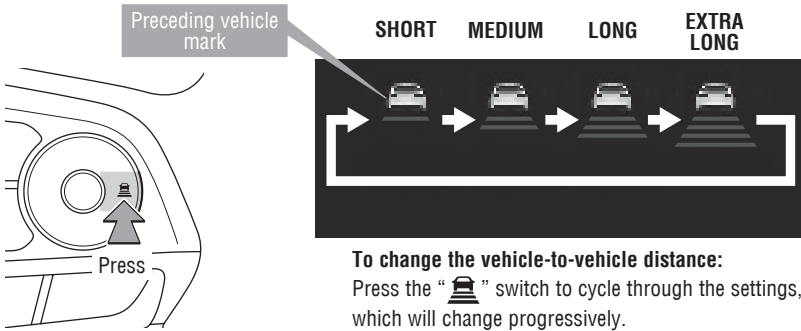

The actual vehicle-to-vehicle distance varies in accordance with the vehicle speed. Also, when the vehicle is stopped by system control, it will be stopped at a certain distance from the preceding vehicle, depending on the situation, regardless of the setting.

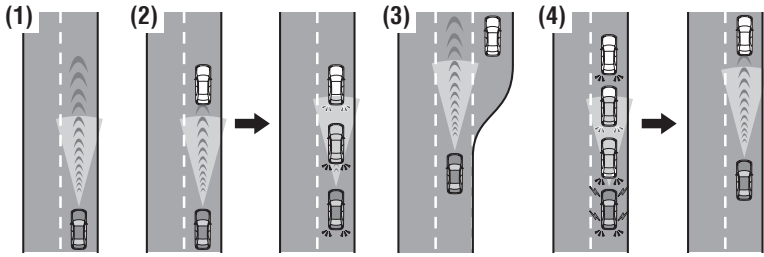

(1) Constant speed cruising when there are no vehicles ahead

The vehicle travels at the speed set by the driver. If the set vehicle speed is exceeded while driving down a hill, the set vehicle speed display will blink and a buzzer will sound.

(2) Deceleration cruising and follow-up cruising when a preceding vehicle driving slower than the set vehicle speed is detected

When a slower vehicle is detected running ahead of your vehicle, the vehicle automatically decelerates and if a greater reduction in vehicle speed is necessary, the brakes may be applied (the brake lights will come on at this time). The vehicle is controlled to maintain the vehicle-to-vehicle distance set by the driver, in accordance with changes in the speed of the preceding vehicle. If vehicle deceleration is not sufficient and the vehicle approaches the vehicle ahead, the approach warning will sound.

(3) Acceleration when there are no longer any preceding vehicles driving slower than the set vehicle speed

The vehicle accelerates until the set vehicle speed is reached and then resumes constant speed cruising.

(4) Starting off

If a preceding vehicle stops, the vehicle will also stop (controlled stop). After the preceding vehicle starts off, pressing the “RES” switch or depressing the accelerator pedal will resume follow-up cruising (start off operation). If a start off operation is not performed, the controlled stop will continue.

Note: When your vehicle is too close to a vehicle ahead, and sufficient automatic deceleration via the cruise control is not possible, the display will flash and the buzzer will sound to alert the driver. An example of this would be if another driver cuts in front of you while you are following a vehicle. Depress the brake pedal to ensure an appropriate vehicle-to-vehicle distance.

ADDITIONAL DRCC SETTINGS

- (1) Press “<>” or “↕” switches and select “⚙️ (4.2-in display)” or “⚙️ (7-in display)” from the Multi-Information Display (MID).
- (2) Press “<>” or “↕” switches and select “🚗 Vehicle Settings” then press and hold “OK.”
- (3) Press “<>” or “↕” switches and select “🚗 DRCC” and then press “OK.”
The setting screen is displayed.
- (4) Press “<>” or “↕” switches to select a DRCC setting from the menu, and the press “OK” to change the desired setting.
- (5) Press “↩” to go back to the menu.

Refer to the Toyota “Owner’s Manual” for additional information on DRCC operation, settings adjustments, limitations, and precautions before attempting to use it.

Cruise Control

Intended for highway use, Cruise Control lets you drive at a preset speed. The system is designed to function at speeds greater than 20 mph.

Refer to the Toyota “Owner’s Manual” for a list of additional situations in which the system operation may be limited.

Meter display

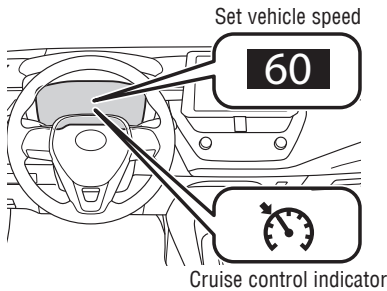

Switches

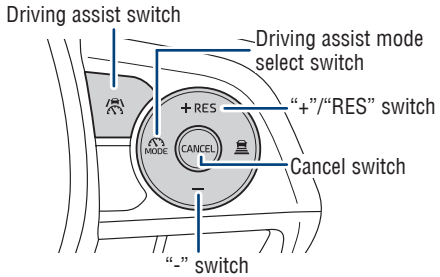

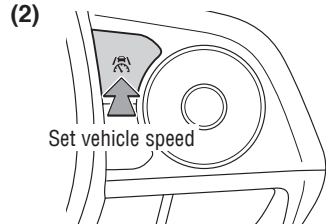
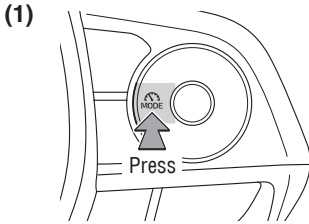

TOYOTA SAFETY SENSE™

ACTIVATING CRUISE CONTROL





Vehicle will cruise at a set vehicle speed.

- (1) Press “MODE” switch to select “Cruise Control Mode.” The cruise control indicator “” will illuminate.
- (2) Using the accelerator pedal, accelerate or decelerate to the desired vehicle speed (approximately 20 mph [30 km/h] or more), and press “” switch to set the set vehicle speed. The set vehicle speed will be displayed on the Multi-Information Display (MID).

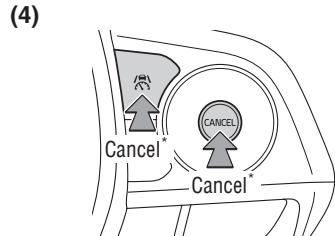
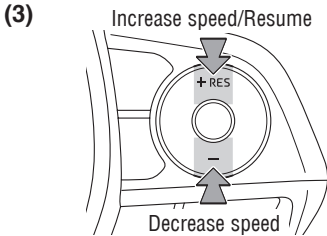
ADJUSTING SET VEHICLE SPEED



- (3) To change the set vehicle speed, press the “+” (increase) or “-” (decrease) switch until the desired speed is displayed. Press and hold to continuously adjust the speed in 1 mph (1.6 km/h) increments, or use a single press to adjust in individual increments of 1 mph (1.6 km/h).
- (4) Press “” switch or “” switch to cancel the speed control.
(Press the “” switch to resume control.)

* The speed control may also be canceled by depressing the brake pedal.

Note: NOTE: On steep downhills, or where there are sudden changes between sharp up and down gradients, vehicle speed may exceed the set speed when driving down a steep hill.

Refer to the Toyota “Owner’s Manual” for additional information on Cruise Control operation, settings adjustments, limitations, and precautions before attempting to use it.

Automatic High Beams (AHB)

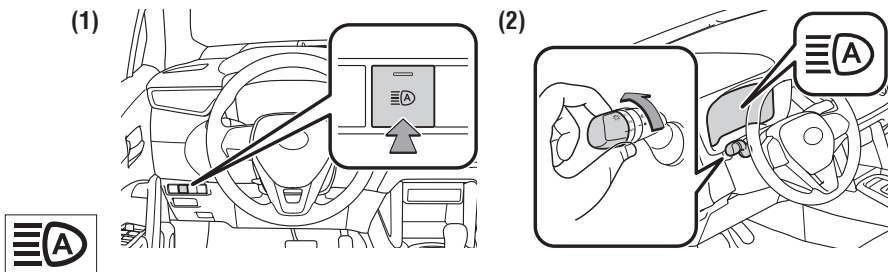

The Automatic High Beams (AHB) safety system is designed to help the driver see more clearly at night. At speeds above 21 mph, AHB can detect the headlights of oncoming vehicles and taillights of preceding vehicles, then automatically toggles between high and low beams accordingly.

See www.toyota.com/safety-sense for more information.

Refer to the Toyota "Owner's Manual" for additional information on AHB operation, settings adjustments, limitations, and precautions before attempting to use it.

ACTIVATING THE AHB SYSTEM

- (1) Press the "☰A" switch.
- (2) Turn the headlight switch to the "☰D" or "AUTO" position.

The AHB indicator "☰A" will come on when the headlights are on and the headlight switch lever is in the low beam position to indicate the system is active.

Note: Push the lever away from you to manually turn on high beams. Press the AHB switch to turn the AHB system off.

CONDITIONS WHERE AHB WILL TURN ON/OFF AUTOMATICALLY

When all of the following conditions are met, the high beams will be automatically turned on (after approximately 1 second):

- Vehicle speed is approximately 21 mph (34 km/h) or more.
- The area ahead of the vehicle is dark.
- There are no oncoming or preceding vehicles with headlights or taillights turned on.
- There are few streetlights or other lights on the road ahead.

If any of the following conditions occur, the high beams will be automatically turned off:

- Vehicle speed drops below approximately 17 mph (27 km/h).
- The area ahead of the vehicle is not dark.
- Oncoming or preceding vehicles have headlights or taillights turned on.
- There are many streetlights or other lights on the road ahead.

TEMPORARILY SWITCHING TO THE LOW BEAMS

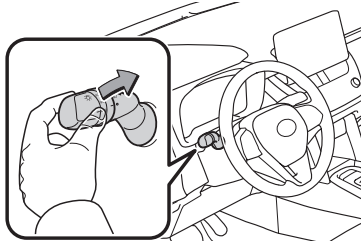

Pull the lever rearward and then return it to its original position to switch to the low beams temporarily.

The high beams will illuminate while the lever is pulled. However, after the lever is returned to its original position, the low beams will remain on for a certain period of time. Afterwards, the Automatic High Beams will be activated again.

NOTE: It is recommended to switch to the low beams when use of the high beams is inappropriate or the high beams may cause problems or distress to other drivers or pedestrians nearby.

Road Sign Assist (RSA)

Using the forward-facing camera and/or navigation system (if equipped), Road Sign Assist (RSA) is designed to detect certain road signs and display them on the instrument cluster.

*All vehicle actions must be driver-initiated and are not automated.
Refer to the Toyota "Owner's Manual" for additional information and limitations.*

SUPPORTED TYPES OF ROAD SIGNS

The following types of road signs can be displayed.



Speed limit



Do Not Enter



No U-turn



No Turn On Red



Stop







Yield



Warning





Depending on the specifications of the vehicle, signs may be displayed overlapping.

SYSTEM ON/OFF

- (1) Press “<>” or “↕” switches and select “ (4.2-in display)” or “ (7-in display)” from the Multi-Information Display (MID).
- (2) Press “<>” or “↕” switches and select “ RSA” and then press “” to turn RSA On/Off.
- (3) Press “↩” to go back to the menu.

Note: If the vehicle was last turned off while a speed limit sign was displayed on the Multi-Information Display (MID), the same sign displays again when the vehicle is turned back ON.

ADDITIONAL RSA SETTINGS





- (1) Press “<>” or “↕” switches and select “ (4.2-in display)” or “ (7-in display)” from the Multi-Information Display (MID).
- (2) Press “<>” or “↕” switches and select “ RSA” and then press and hold “.
- (3) Press “<>” or “↕” switches to select an RSA setting from the menu, and press “.
- (4) Press “↩” to go back to the menu.

Refer to the Toyota “Owner’s Manual” for additional information on RSA operation, settings adjustments, limitations, and precautions before attempting to use it.

Proactive Driving Assist (PDA)

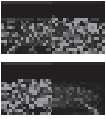
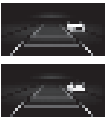
When system operating conditions are met, using the vehicle's camera and radar, Proactive Driving Assist (PDA) provides gentle braking into curves or gentle braking and/or steering to help support driving tasks such as distance control between your vehicle and a preceding vehicle, pedestrian or bicyclist.

SYSTEM OPERATION DISPLAY

Icon	Meaning
	<ul style="list-style-type: none"> • White: Monitoring for detectable objects • Green: Detectable object crossing the road or detectable object on the side of the road assistance operating
	A pedestrian has been detected as crossing the road or on the side of the road and brake or steering assistance is operating
	A vehicle has been detected on the side of the road and brake or steering operation assistance is being performed
	Steering operation assistance is being performed to prevent the vehicle from approaching too close to a detectable object on the side of the road
	Preceding vehicle deceleration assistance is being performed
	Warning to maintain appropriate vehicle-to-vehicle distance
	Curve deceleration assistance is being performed

TURNING PDA ON/OFF

- (1) Press “<>” or “⬠” switches and select “⚙️ (4.2-in display)” or “⚙️ (7-in display)” from the Multi-Information Display (MID).
- (2) Press “<>” or “⬠” switches and select “(🚗) PDA” and then press “OK” to turn PDA On/Off.
- (3) Press “➡️” to go back to the menu.

ADJUSTING PDA SUPPORT TIMING

- (1) Press “<>” or “↕” switches and select “⚙️ (4.2-in display)” or “⚙️ (7-in display)” from the Multi-Information Display (MID).
- (2) Press “<>” or “↕” switches and select “(PDA) PDA” and then press and hold “OK.” The setting screen is displayed.
- (3) Press “<>” or “↕” switches and select “Sensitivity” and then press “OK” to change the desired setting. Each time it is pressed, the timing options changes “Later”, “Default” or “Earlier.”
- (4) Press “↩” to go back to the menu.

OBSTACLE ANTICIPATION ASSIST (OAA)

Obstacle Anticipation Assist (OAA) is designed to detect vehicles parked on the side of the road, or pedestrians or bicyclists on the side of the road or crossing the road, and depending on the circumstances, OAA may provide mild braking and/ or steering assist to control distance between the detected object and the vehicle. This system operates at vehicle speeds of approximately 20-35 mph (30-60 km/h).

TURNING OBSTACLE ANTICIPATION ASSIST (OAA) ON/OFF

- (1) Press “<>” or “↕” switches and select “⚙️ (4.2-in display)” or “⚙️ (7-in display)” from the Multi-Information Display (MID).
- (2) Press “<>” or “↕” switches and select “(PDA) PDA” and then press and hold “OK.” The setting screen is displayed.
- (3) Press “<>” or “↕” switches and select “OAA” or “Obstacle Anticipation Assist” and then press “OK” to turn the system On/Off.
- (4) Press “↩” to go back to the menu.

DECELERATION ASSIST (DA)

Deceleration Assist (DA) is designed to provide braking assist and gently reduce vehicle speed when the system detects preceding vehicles or certain upcoming curves in the road and the driver is not pressing on the accelerator or brake pedals. This feature operates at speeds above approximately 15 mph (20 km/h). DA does not provide steering support and will not bring the vehicle to a complete stop.

TURNING DECELERATION ASSIST (DA) ON/OFF







- (1) Press “<>” or “↕” switches and select “⚙️ (4.2-in display)” or “⚙️ (7-in display)” from the Multi-Information Display (MID).
- (2) Press “<>” or “↕” switches and select “(PDA) PDA” and then press and hold “OK.” The setting screen is displayed.
- (3) Press “<>” or “↕” switches and select “DA” or “Deceleration Assist” and then press “OK” to turn the system On/Off.
- (4) Press “↩” to go back to the menu.

TOYOTA SAFETY SENSE™

STEERING ASSIST (SA)

PDA Steering Assist (SA) is designed to detect the lines of the roadway and vary the assistance from the power steering to help the driver stay within the lane. Steering Assist does not actively steer the vehicle. This feature is designed to operate at vehicle speeds between 5-80 miles per hour and does not require DRCC to be engaged.

TURNING STEERING ASSIST (SA) ON/OFF

- (1) Press “<>” or “◊” switches and select “ (4.2-in display)” or “ (7-in display)” from the Multi-Information Display (MID).
 - (2) Press “<>” or “◊” switches and select “ PDA” and then press and hold “.
 The setting screen is displayed. - (3) Press “<>” or “◊” switches and select “SA” or “Steering Assist” and then press “.
- (4) Press “” to go back to the menu.

Refer to the Toyota “Owner’s Manual” for additional information on PDA operation, settings adjustments, limitations, and precautions before attempting to use it.

Seat belts

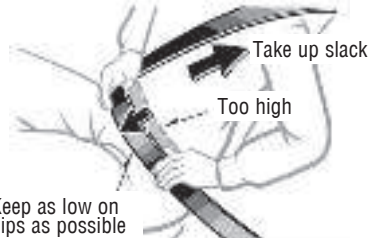

NOTE: If a passenger's seat belt is fully extended, then retracted even slightly, the Automatic locking retractor (ALR) will prevent it from being re-extended beyond that point, unless fully retracted again. This feature is used to help hold child restraint systems securely.

To find more information about seat belts, and how to install a child restraint system, refer to the "Owner's Manual".

Seat belts-Shoulder belt anchor

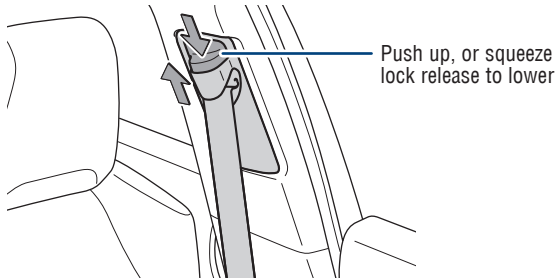

SAFETY & EMERGENCY FEATURES

Rear door child safety locks

Rear door

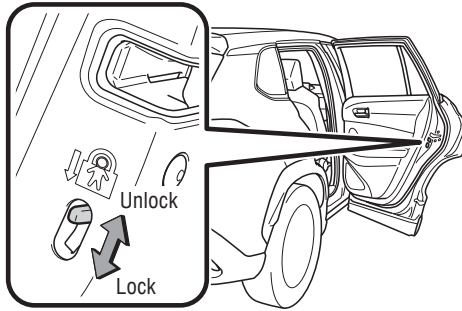

Moving the lever downward will allow the door to be opened only from the outside.

Safety Connect®

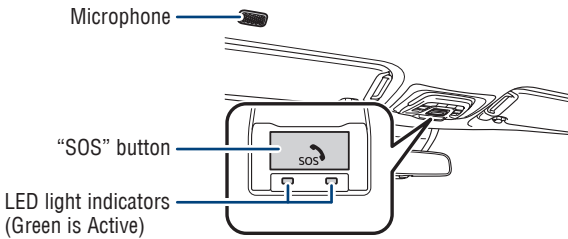

Safety Connect is a subscription-based telematics service that uses Global Positioning System (GPS) data and embedded cellular technology to provide safety and security features to subscribers. Safety Connect is staffed with live agents at the Toyota response center, which operates 24 hours per day, 7 days per week.

Services for subscribers include:

- Automatic collision notification
- Stolen vehicle locator
- Emergency assistance (“SOS” button)
- Enhanced roadside assistance

For limitations and additional information, refer to the “Owner’s Manual” or visit www.toyota.com/connected-services.

Tire repair kit & tools (if equipped, Corolla Cross Hybrid only*)

* Not applicable to Corolla Cross.

TOOL LOCATION

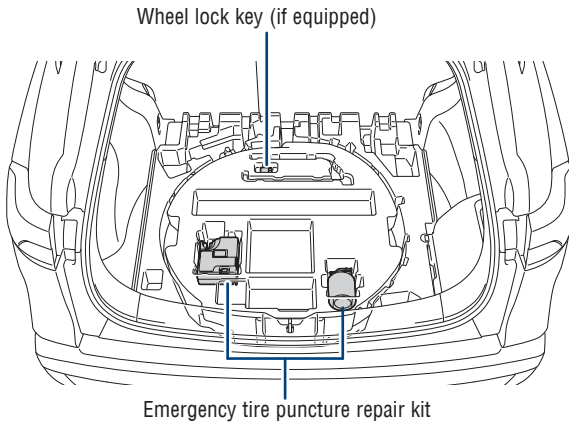

TIRE REPAIR KIT COMPONENTS

Bottle

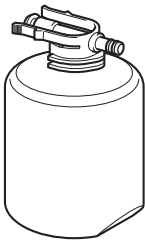

Sticker



Compressor

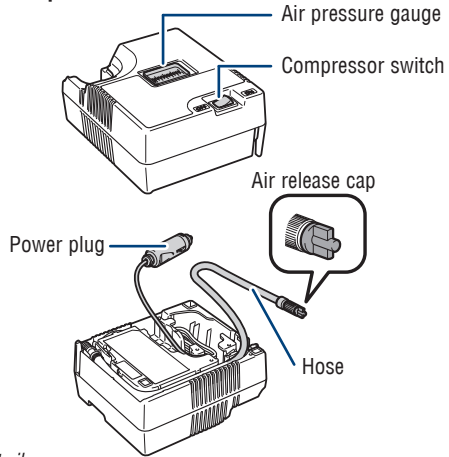

Refer to the "Owner's Manual" for more details.

SAFETY & EMERGENCY FEATURES

Spare tire & tools (if equipped, Corolla Cross only*)

* Not applicable to Corolla Cross Hybrid.

TOOL LOCATION

2WD models

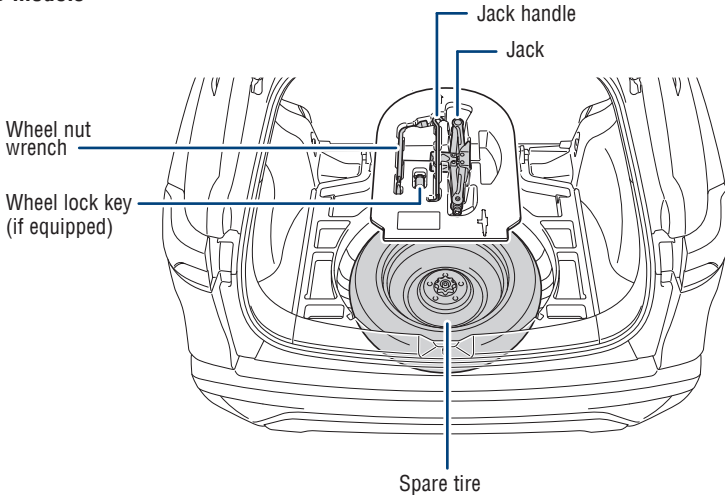

AWD models

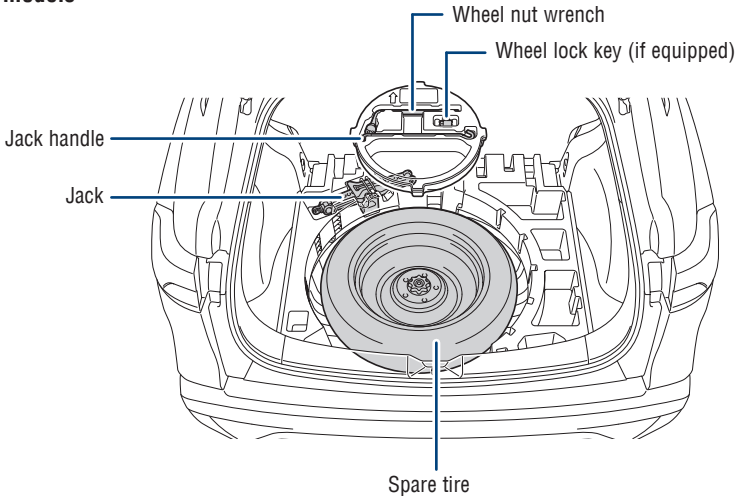

REMOVE THE SPARE TIRE

- (1) Remove the luggage floor cover.

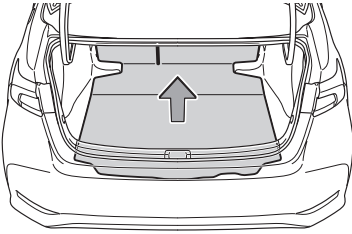

- (2) Remove the tool tray.

2WD models

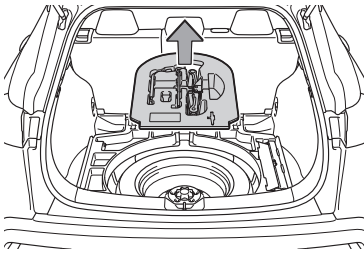

AWD models

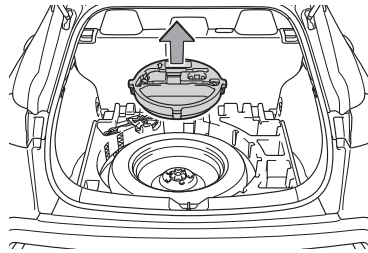

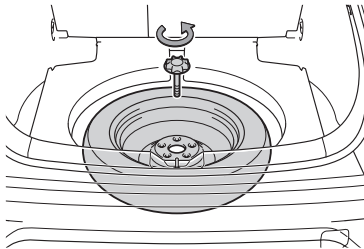

- (3) Loosen the center fastener that secures the spare tire.





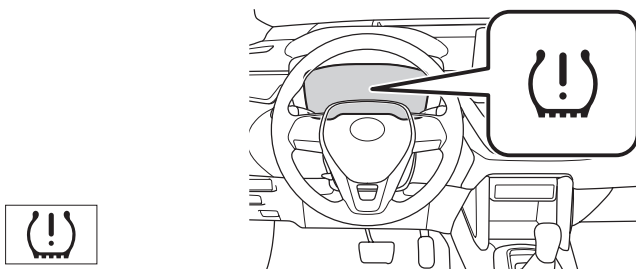









Refer to the "Owner's Manual" for tire changing and jack positioning procedures.

Tire Pressure Monitoring (warning) System (TPMS)



The tire pressure warning system can be selected on “ (4.2-in display)” or “ (7-in display)” of the Multi-Information Display (MID).

System reset initialization

- (1) Press “” or “” switches and select “ (4.2-in display)” or “ (7-in display)” from the Multi-Information Display (MID).
- (2) Press “” or “” switches and select the “Vehicle Settings,” then press and hold “.
- (3) Press “” or “” switches and select “TPWS setting” and then press “.
- (4) Press “” or “” switches and select “Set Pressure” then press and hold “.

The tire pressure detected by the tire pressure warning system can be displayed on the Multi-Information Display (MID).

If the tire pressure indicator flashes for approximately 1 minute and then remains on, take the vehicle to your local Toyota dealer.

Refer to the load label on the door jamb or the “Owner’s Manual” for tire inflation specifications.

NOTE: The warning light may come on due to temperature changes or changes in tire pressure from natural air leakage. If the system has not been initialized recently, setting the tire pressures to factory specifications should turn off the light.

Star Safety System™

Your vehicle comes standard with the Star Safety System™, which combines Anti-lock Braking System (ABS), Brake Assist (BA), Electronic Brake-force Distribution (EBD), Smart Stop Technology (SST), Traction Control (TRAC) and Vehicle Stability Control (VSC).

Refer to the “Owner’s Manual” for more details and important information on limitations to these systems.

ANTI-LOCK BRAKE SYSTEM (ABS)

Toyota’s Anti-lock Brake System detects which wheels are locking up and limits wheel lockup by “pulsing” each wheel’s brakes independently. Pulsing releases brake pressure repeatedly for fractions of a second. This helps the tires attain the traction that current road conditions will allow, helping you to stay in directional control.

BRAKE ASSIST (BA)

Brake Assist is designed to detect sudden or “panic” braking, and then add braking pressure to help decrease the vehicle’s stopping distance. When there’s only a split second to react, Brake Assist can add additional brake pressure more quickly than just the driver alone can.

ELECTRONIC BRAKE FORCE DISTRIBUTION (EBD)

Toyota’s ABS technology has Electronic Brake-force Distribution (EBD) to help maintain control and balance when braking. EBD responds to sudden stops by redistributing brake force to enhance the braking effectiveness of all four wheels.

SMART STOP TECHNOLOGY (SST)

Smart Stop Technology automatically reduces engine power when the accelerator and brake pedals are pressed simultaneously under certain conditions.

SST engages when the accelerator is depressed first and the brakes are applied firmly for longer than one-half second at speeds greater than five miles per hour.

SST doesn’t engage if the brake pedal is depressed before the accelerator pedal, allowing vehicles to start on a steep hill and safely accelerate without rolling backward.

ENHANCED VEHICLE STABILITY CONTROL (VSC)

Enhanced Vehicle Stability Control provides cooperative control of the ABS, TRAC, VSC and EPS.

Enhanced VSC helps to maintain directional stability when loss of traction occurs during a turn.

SAFETY & EMERGENCY FEATURES

TRACTION CONTROL (TRAC)

VSC helps prevent loss of traction during cornering by reducing engine power, and Traction Control helps maintain traction on loose gravel and wet, icy, or uneven surfaces by applying brake force to the spinning wheel(s).

Toyota's TRAC sensors are activated when one of the drive wheels starts to slip. TRAC limits engine output and applies the brakes to the spinning wheel. This transfers power to the wheels that still have traction to help keep you on track.

Floor mat installation

There are two types of Toyota floor mats: carpeted and all-weather. Each vehicle has model-specific floor mats. Installation is easy.

To keep your floor mat properly positioned, follow these steps:

- Only use Toyota floor mats designed for your specific model.
- Only use one floor mat at a time, using the equipped fasteners to keep the mat in place.
- Install floor mats right side up.

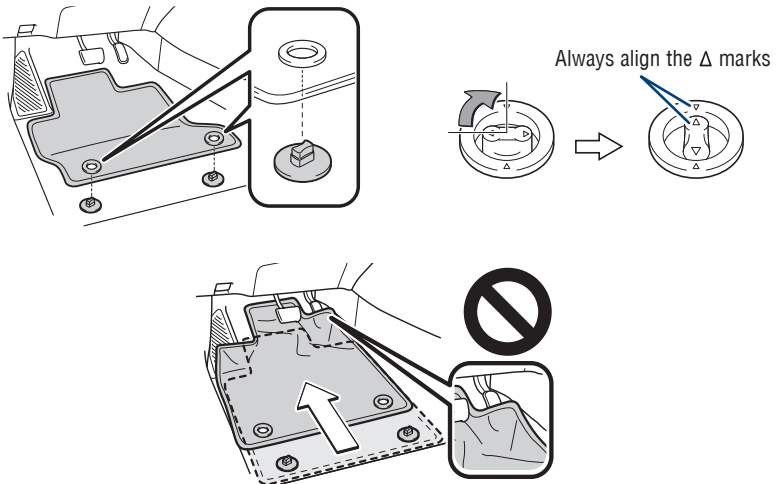

GETTING STARTED WITH TOYOTA AUDIO MULTIMEDIA AND CONNECTED SERVICES

- Registering Your Vehicle
- Toyota app
- Bluetooth® Pairing
- Connected Services
- Apple CarPlay®
- Android Auto™
- SiriusXM®
- Online Support Tool
- Updating System Software

Scan QR Code to Download Toyota app

Apple



Android



Do not attempt the process while driving.

Registering Your Vehicle

With the Toyota app, you will be connected to your Toyota on the go. Use the app to personalize your profile and take the customized vehicle settings and preferences for the multimedia features you enjoy most with you too. Get real time vehicle health information, enjoy remote service, manage your Connected Services subscriptions and more.



STEP 1 Start the vehicle and select your language preference.



STEP 2 Select "Enter phone number".



STEP 3 Enter your mobile phone number to receive a link to download the Toyota app.

STEP 4 Download and open the Toyota app on your device and follow instructions to add your vehicle by scanning the QR Code displayed on your vehicle's screen. Complete the steps in your Toyota app to create your profile, activate included trial services and enable access in your vehicle.



STEP 5 Once complete, select "I've completed app setup".



STEP 6 A welcome banner will be displayed on screen to confirm linking is complete.

Toyota app



TOYOTA

Toyota app allows access to valuable information about your vehicle and control of capable features equipped with your vehicle.

- Manuals & Warranties
- Schedule Maintenance
- Roadside Assistance
- Vehicle Health Report
- SiriusXM[®] Radio
- Safety Recalls
- Toyota Financial Services - Vehicle Payment

Remote Connect equipped vehicle functions (*if equipped):

- Lock/Unlock*
- Start Vehicle*
- Vehicle Finder*
- Guest Driver settings*
- Hazard Lights On*
- Horn Alert*
- Buzzer Alert*
- Lock/Unlock Hatch*
- Remote Climate*

Scan QR Code to Download Toyota app.

Apple



Android



Or

Search "Toyota" at your applicable app store.



If you have a Toyota Owner's account, use your credentials to "Sign In" and get started with Toyota app.

Or

If you do not have a Toyota Owner's account, "Register" now to get started with Toyota app.



Bluetooth® Pairing¹

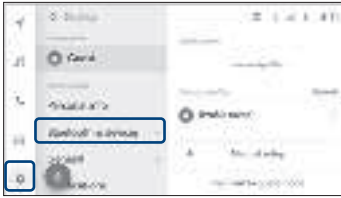

Note:
Do not attempt the Bluetooth®
Pairing process while driving.

STEP 1 Select [**GEAR ICON**] from the main menu, then “**Bluetooth & Devices.**”



iPhone Bluetooth Menu Android Bluetooth Menu

STEP 2 Ensure Bluetooth is turned on for your phone.



STEP 3 Select “**Manage devices**”, then “**Search for devices.**”



STEP 4 Select “**Device name**” to register.

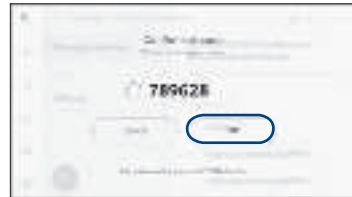

STEP 5 Check that the displayed PIN code matches the PIN code displayed on the Bluetooth® device, and then select [**OK**].

Bluetooth® Pairing¹ (continued)



STEP 6 If your device supports Apple CarPlay / Android Auto, select “Yes” to enable.



STEP 7 While pairing your device, a message may display asking to check your device to allow syncing contacts and allow messaging.

Note: You may also select “Skip” on display screen to skip enabling notifications. If skipped, proceed to **STEP 9**.



STEP 8 Turn on “Show Notifications” for iPhone® or “ON” for Android.



STEP 9 A confirmation will appear once your phone has been paired and connected.

Connected Services²

Your vehicle may come available with a trial period for the following Connected Services.

Learn more at www.toyota.com/connected-services/.

Safety Connect³

- (SOS) EMERGENCY ASSISTANCE BUTTON
- AUTOMATIC COLLISION NOTIFICATION
- ROADSIDE ASSISTANCE
- STOLEN VEHICLE LOCATOR

Remote Connect⁴ (*if equipped)

- START VEHICLE*
- VEHICLE STATUS ALERTS*
- HAZARD LIGHTS ON*
- BUZZER ALERT*
- REMOTE CLIMATE*
- LOCK/UNLOCK VEHICLE DOORS*
- VEHICLE FINDER*
- HORN ALERT*
- LOCK/UNLOCK HATCH*

Completing the registration process is required to enable Remote Connect.

Service Connect⁵ (if equipped)

- VEHICLE HEALTH REPORT
- VEHICLE MAINTENANCE ALERT NOTIFICATION

Completing the registration process is required to enable Service Connect.

Drive Connect

- CLOUD NAVIGATION
- DESTINATION ASSIST
- INTELLIGENT ASSISTANT

GETTING STARTED WITH

Connected Services² (continued)

Wi-Fi Connect⁷

Multiple mobile devices

- Connect up to 5 Wi-Fi enabled devices
- Passengers can use smartphones, laptops and tablets

Infotainment

- Browse the internet
- Send and receive email
- Stay connected on social media
- Access favorite apps
- Stream movies



Several factors may affect smartphone and/or system performance including:

1. Smartphone operating system software version
2. Smartphone battery power level
3. Poor cellular reception to the smartphone
4. Multiple applications running on a smartphone at the same time
5. Charge/media cable quality
6. Smartphone operating system updates may also affect Toyota app functionality

For additional information, please visit: www.toyota.com/connected-services

Connected Services Online Support



Toyota's online support tool provides intuitive "How-To" instruction and videos.

To begin, please visit: <https://toyotaaudioandconnectedservicesupport.com/>

Apple CarPlay® (Compatible iPhone® required)

Setup of Apple CarPlay®



STEP 1 Ensure Siri® is enabled on your phone.



STEP 2 Plug a compatible iPhone® into the USB media port using an Apple® approved cable or have the smartphone and vehicle connected through Bluetooth®.

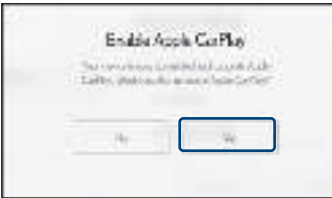

STEP 3 On the multimedia system, select “Yes” when asked if you would like to Enable Apple CarPlay®.



STEP 4 Select Allow to use CarPlay® while the phone is locked.



* Screen depiction accurate at time of posting.

STEP 5 To launch Apple CarPlay®, select the Apple CarPlay® icon on the top of the side menu bar.



* Screen depiction accurate at time of posting.

STEP 6 Apple CarPlay® is now ready to operate. You can go back to the Toyota multimedia system by using the Toyota icon in the Apple CarPlay® screen.

Requirements:

Bluetooth® functions will be inoperable while CarPlay® is in use. Wireless CarPlay® is supported. Features may vary by vehicle model and phone.

To learn more about how your iPhone® works with CarPlay® visit: <https://support.apple.com/en-us/HT205634>

To view a full list of CarPlay® supported apps visit: <https://www.apple.com/ios/carplay/>

GETTING STARTED WITH

Apple CarPlay® (Compatible iPhone® required) (continued)

Siri® through CarPlay®

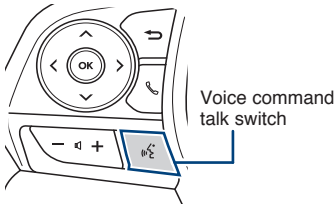

Press and hold the voice command talk switch for 2-3 seconds to activate.



* Screen depiction accurate at time of posting.

Once Siri® is activated you can ask to: make calls, send and receive text messages, listen to music and more.

Android Auto™ (Compatible Android™ device required)

Setup of Android Auto™



STEP 1 With Android 9 or below, the Android Auto™ app download is required. With Android 10, Android Auto™ is built in and the app is NOT required.



STEP 2 Open Android Auto™ app and tap get started.



STEP 3 Ensure Android Auto™ is enabled on the phone.



STEP 4 Plug a compatible Android™ smartphone into the USB media port using an Android approved cable or have the smartphone and vehicle connected through Bluetooth®.

Setup of Android Auto™ (continued)

STEP 5 On the multimedia system, select “Yes” when asked if you would like to Enable Android Auto™.



STEP 6 To launch Android Auto™, select the Android Auto™ icon on the top of the side menu bar.



* Screen depiction accurate at time of posting.

STEP 7 Android Auto™ is now ready to operate. You can go back to the Toyota multimedia system by using the Toyota icon in the Android Auto™ screen.

Requirements:

Bluetooth® functions will be inoperable while Android Auto™ is in use. Wireless Android Auto™ is supported. Features may vary by vehicle model and phone.

To learn more about how to use Android Auto™ visit: <https://www.android.com/auto>

Google Assistant through Android Auto™

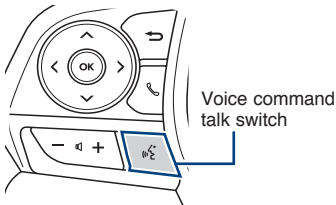

Press and hold the voice command talk switch for 2-3 seconds to activate.



* Screen depiction accurate at time of posting.

Once Google Assistant is activated, you can ask to: make calls, send and receive text messages, listen to music and more.

GETTING STARTED WITH

SiriusXM® 8 (If equipped)

SiriusXM® Audio



* Screen depiction accurate at time of posting.

Toyota vehicles equipped with SiriusXM® come with a 3-month Platinum Plan trial subscription. With the Platinum Plan, you get 425+ channels, including 165+ channels in your vehicle to enjoy ad-free music, plus sports, news, talk, comedy and more. Experience even more on the SXM App, featuring a collection of podcasts, Xtra channels of music, personalized Pandora® stations, SiriusXM video and more.



Audio Multimedia Online Support



Toyota's online support tool provides intuitive "How-To" instruction and videos.

To begin, please visit: <https://toyotaaudioandconnectedservicesupport.com/>

Updating System Software

The Toyota Audio Multimedia system is capable of over-the-air, over Wi-Fi®, and through USB flash drive updates. To use this function it is necessary to opt-in to the Connected Service Master Data Consent. When the Toyota Audio Multimedia system software is updated, the operating methods of functions may change. Each update will identify the proper updating method to one or all of the following methods:

- Update the software using the Data Communication Module (DCM)
- Update the software using Wi-Fi
- Update the software using a USB flash drive

See the Owner's Manual for complete details on the updating procedure.

After updating make sure to read the Digital Navigation Owner's Manual corresponding to the current software version available at <https://www.toyota.com/owners/resources/warranty-owners-manuals>.

Privacy & Protection

To learn about Toyota's Connected Services data collection, use, sharing and retention, visit: www.toyota.com/privacyvts.

- ¹ The Bluetooth word mark and logos are registered trademarks owned by Bluetooth SIG, Inc. and any use of such marks by Toyota is under license. A compatible Bluetooth enabled phone must first be paired. Phone performance depends on software, coverage and carrier.
- ² Visit Toyota.com/connected-services or see your local Toyota Dealer for additional details.
- ³ Safety Connect depends on an operative telematics device, a cellular connection, GPS signal strength and other factors outside of Toyota's control, all of which can limit system functionality or availability, including access to response center and emergency support. Stolen vehicle police report required to use Stolen Vehicle Locator. Some features may require the Toyota app. Registration required. Subscription required after trial. Service subject to change at any time without notice. Terms of Use apply. Data charges may apply. Service may vary by vehicle and region. See usage precautions and service limitations in Owner's Manual and Toyota.com/connected-services/ for additional details.
To learn about Toyota's data collection, use, sharing and retention practices, please visit <https://www.toyota.com/privacyvts/>.
- ⁴ Toyota - Remote Connect
Use only if aware of circumstances surrounding vehicle and it is legal and safe to do so (e.g., do not remotely start engine if vehicle is in an enclosed space or vehicle is occupied by a child). Toyota Remote Connect depends on an operative telematics device, a cellular connection, GPS signal strength and other factors outside of Toyota's control, which can limit system functionality and availability. Service may vary by vehicle and region. Registration and Toyota app download required. Subscription required after trial. Terms of Use apply. Data charges may apply. Remote start/stop not available on manual transmission-equipped vehicles. Services subject to change at any time without notice. See usage precautions and service limitations in Toyota Owner's Manual and <https://www.toyota.com/connected-services> for additional details.
To learn about Toyota's data collection, use, sharing and retention practices, please visit <https://www.toyota.com/privacyvts/>.
- ⁵ Service Connect information provided is based on the last time data was collected from the vehicle and is not real time data. Service Connect depends on an operative telematics device, a cellular connection, GPS signal strength and other factors outside of Toyota's control, which can limit functionality or availability. Service may vary by vehicle and region. Registration required. Subscription required after trial. Service subject to change at any time without notice. Terms of Use apply. Data charges may apply. See usage precautions and service limitations in Owner's Manual and Toyota.com/connected-services for additional details.
To learn about Toyota's data collection, use, sharing and retention practices, please visit <https://www.toyota.com/privacyvts/>.
- ⁶ Destination Assist depends on an operative telematics device, a cellular connection, navigation map data and GPS signal strength and other factors outside of Toyota's control, which can limit system ability functionality or availability. Use common sense when relying on this information. Service may vary by vehicle and region. Registration required. Subscription required after trial. Services subject to change at any time without notice. Terms of Use apply. Data charges may apply. See Owner's Manual and Toyota.com/connected-services for additional limitations and details.
To learn about Toyota's data collection, use, sharing and retention practices, please visit <https://www.toyota.com/privacyvts/>.
- ⁷ Wi-Fi Connect is available on select 2018 and newer Toyota vehicles.
Visit Toyota.com/connectedservices for vehicle availability.
- ⁸ SiriusXM® audio services require a subscription sold separately by Sirius XM Radio Inc. To cancel, you must call SiriusXM at 1-866-635-2349. See SiriusXM Customer Agreement for complete terms at www.siriusxm.com.
All fees and programming subject to change. Not all vehicles or devices are capable of receiving all services offered by SiriusXM.
SiriusXM and all related marks and logos are trademarks of Sirius XM Radio Inc.



Printed in U.S.A. 10/23
23-MKG-17925



TOYOTA

Quick Reference Guide 2024



00505QRG24CCR

toyota.com