

# **YAESU**

*Radio for Professionals*

VHF FM TRANSCEIVER

# **FT-3185R**

# **FT-3185E**

## Operating Manual

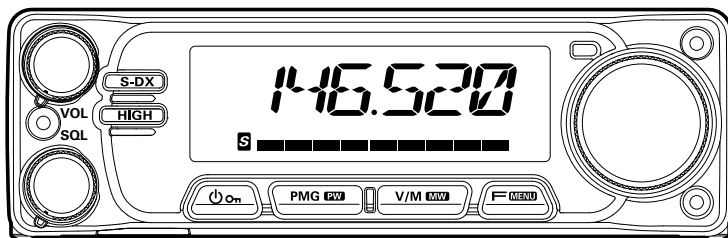

# Index

|  |  |
|--|--|
| <b>FT-3185R/FT-3185E Quick Reference Guide</b> .... 1      |  |
| <b>Introduction</b> ..... 2                                |  |
| New Features of the Yaesu FT-3185R/FT-3185E .. 2           |  |
| Other Features..... 2                                      |  |
| <b>Accessories &amp; Options</b> ..... 3                   |  |
| Supplied Accessories..... 3                                |  |
| Optional Accessories..... 3                                |  |
| About this manual..... 3                                   |  |
| <b>Basic Operation</b> ..... 4                             |  |
| Turning the Transceiver ON and OFF..... 4                  |  |
| Adjusting the volume..... 4                                |  |
| Adjusting the squelch Setting..... 4                       |  |
| Tuning to a Frequency..... 4                               |  |
| DIAL knob..... 4   |  |
| The numeric keys on microphone..... 4                      |  |
| Transmitting..... 5  |  |
| Changing the Transmitter Power Level..... 5                |  |
| Locking the Keys and DIAL knob..... 5                      |  |
| <b>New Features</b> ..... 6                                |  |
| Function List..... 6                                       |  |
| Setting functions using the function list..... 7           |  |
| Setting functions using the Set Up Menu..... 7             |  |
| Registration to the Function List..... 8                   |  |
| Cancel registration in the Function List..... 8            |  |
| PMG (Primary Memory Group)..... 9                          |  |
| PMG Screen..... 9  |  |
| Register the frequency to PMG..... 9                       |  |
| Unregister a Channel (Frequency) from PMG... 10            |  |
| Super DX plus Noise Cancelling..... 11                     |  |
| Installing the Audio Signal Processing                     |  |
| Unit "SPU-1"..... 11                                       |  |
| <b>Front and Rear Panel Controls &amp; Switches</b> ... 12 |  |
| <b>Microphone Switches</b> ..... 14                        |  |
| <b>Safety Precautions</b> ..... 16                         |  |
| <b>Installation</b> ..... 18                               |  |
| About the Antenna..... 18                                  |  |
| Connection of Antenna and Power Cables..... 18             |  |
| Installing the Transceiver..... 19                         |  |
| Installing the Microphone..... 19                          |  |
| Base Station Feet..... 19                                  |  |
| <b>Advanced Operation</b> ..... 20                         |  |
| Weather Broadcast Reception                                |  |
| (USA version only)..... 20                                 |  |
| Severe Weather Alert Feature..... 20                       |  |
| LOCK Feature..... 21                                       |  |
| Keyboard Beeper..... 21                                    |  |
| Channel Step Selection..... 21                             |  |
| Display Brightness..... 21                                 |  |
| <b>Repeater Operation</b> ..... 22                         |  |
| Reverse function..... 22                                   |  |
| Tone Calling (1750Hz)..... 22                              |  |
| <b>CTCSS/DCS/EPCS Operation</b> ..... 23                   |  |
| CTCSS Operation..... 23                                    |  |
| DCS Operation..... 24                                      |  |
| Tone Search Scanning..... 25                               |  |
| EPCS (Enhanced Paging & Code Squelch)                      |  |
| Operation..... 26  |  |
| Storing the CTCSS Tone Pairs for                           |  |
| EPCS Operation..... 26                                     |  |
| Activating the Enhanced Paging &                           |  |
| Code Squelch System..... 27                                |  |
| CTCSS/DCS/EPCS Bell Operation..... 27                      |  |
| Split Tone Operation..... 27                               |  |
| <b>DTMF Operation</b> ..... 28                             |  |
| Manual DTMF Tone Generation..... 28                        |  |
| DTMF Autodialer..... 28                                    |  |
| Registering the DTMF memory..... 28                        |  |
| Transmitting the registered DTMF code..... 29              |  |
| <b>Memory Operation</b> ..... 30                           |  |
| Memory Storage..... 30                                     |  |
| Storing Independent Transmit Frequencies                   |  |
| ("Odd Splits")..... 30                                     |  |
| Memory Recall..... 30                                      |  |
| Memory Recall from the Microphone's Keypad: 31             |  |
| Erasing memory channel data..... 31                        |  |
| Copying memories..... 31                                   |  |
| Copy memory channel information to VFO..... 31             |  |
| Memory-Only Mode..... 31                                   |  |
| Labeling Memories..... 32                                  |  |
| Home Channel Memory..... 33                                |  |
| Recall the Home Channel..... 33                            |  |
| Recall with the programmable key on the                    |  |
| microphone..... 33   |  |
| Changing the Home Channel Frequency..... 33                |  |
| <b>Scanning</b> ..... 34                                   |  |
| VFO Scan / Memory Scan..... 34                             |  |
| Scan-Resume Options..... 34                                |  |
| Memory Skip Scanning..... 35                               |  |
| Programmable Memory Channel Scan (PMS)... 35               |  |
| Registering to the Programmable                            |  |
| Memory Channels..... 35                                    |  |
| Priority Channel Scanning (Dual Watch)..... 36             |  |
| Activating the Dual Watch (DW) feature..... 36             |  |
| Priority Revert Mode..... 36                               |  |
| Weather Alert Scan (USA version only)..... 37              |  |
| <b>ARTS™ (Automatic Range</b>                              |  |
| <b>Transponder System)</b> ..... 38                        |  |
| Basic ARTS™ Setup and Operation..... 38                    |  |
| <b>Miscellaneous Settings</b> ..... 39                     |  |
| Time-Out Timer (TOT)..... 39                               |  |
| Automatic Power-Off (APO)..... 39                          |  |
| Programming the Key Assignments..... 40                    |  |
| FM Bandwidth & TX Deviation Level..... 41                  |  |
| MIC Gain Setting..... 41                                   |  |
| Busy Channel Lock-Out (BCLO)..... 41                       |  |
| Displaying the Temperature..... 42                         |  |
| Displaying the Supply Voltage..... 42                      |  |
| DCS Code Inversion..... 42                                 |  |
| <b>Reset Procedure</b> ..... 43                            |  |
| All Reset..... 43  |  |
| Set Mode Resetting..... 43                                 |  |
| <b>Setup (Menu) Mode</b> ..... 44                          |  |
| <b>Specifications</b> ..... 53                             |  |
| <b>YAESU LIMITED WARRANTY</b> ..... 54                     |  |

## VOL knob

Adjusts the audio volume level.

## DIAL knob

Selects the operating Frequency.

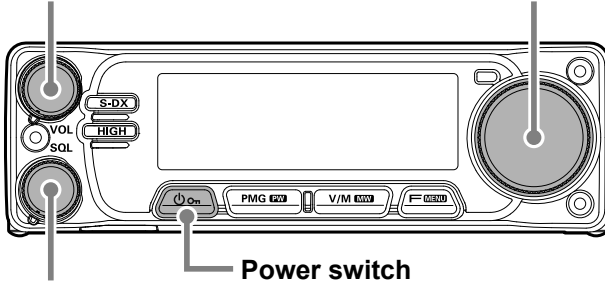

## SQL knob

Adjust to the point where the background noise is muted.

## Power switch

Press and hold for one second.

## Microphone

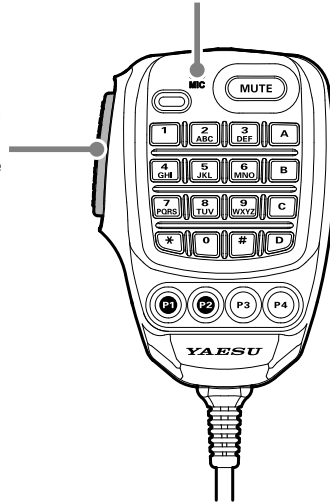

## Transmission Switch

Speak into the microphone in a normal voice level while pressing this switch.



## Introduction

### New Features of the Yaesu FT-3185R/FT-3185E

- ❑ The final power amplifier section has been optimized to achieve a transmit power output of 85W. The transmit power can be selected from 85W, 50W, 20W, or 5W.
- ❑ The new Super DX function increases the sensitivity of the RF amplifier when the received signal is weak, and expands the communication range.
- ❑ Installing the optional “Audio Signal Processing Unit SPU-1”, permits digitally processing the received audio signal to separate and remove noise. The voice can be enhanced to produce clear, comfortable, audio quality. Even weak signals that were previously inaudible due to noise can now be received clearly.
- ❑ The Primary Memory Group Activity Monitor (PMG) function can register up to 5 memory channels or VFO receive frequencies simply by pressing and holding the  key. Press the  key to scan the registered frequencies and when a signal comes in on a channel other than the current channel, the transceiver will automatically receive that signal.
- ❑ The Custom Function List (CFL) can be personalized by registering frequently used functions (up to 9) from the 44 items of the Setup Menu. The functions may then be called up with one touch of the  key or easily selected with the DIAL knob.

### Other Features

- ❑ Keyboard entry of operating frequencies from the microphone.
- ❑ Excellent protection from receiver intermodulation distortion, thanks to Yaesu's renowned Advanced Track Tuning front end.
- ❑ 226 memories (200 “basic” memory channels, 10 sets of band-edge memory channels, one “Home” channel, and 5 “PMG” memory channels) which can store repeater shifts, odd repeater shifts, CTCSS/DCS tones, and 6-character Alpha-Numeric labels for easy channel recognition.
- ❑ 10 NOAA Weather Broadcast Channels, with Weather Alert and a Volume Control for the Weather Alert tone. (USA version only)
- ❑ Built-in CTCSS and DCS Encoder/Decoder circuits.
- ❑ Extensive Menu system, which allows customization of a number of transceiver performance characteristics.

Additional features include a transmit Time-Out-Timer (TOT), Automatic Power-Off (APO), Automatic Repeater Shift (ARS), plus provision for reduction of the Tx deviation in areas of high channel congestion.

Thank you for purchasing the **FT-3185R/E** Transceiver. We urge you to read this manual in its entirety, to gain a full understanding of the amazing capability of the exciting new **FT-3185R/E** Transceiver.

## Supplied Accessories



|   |   |
|---|---|
| Microphone <b>SSM-85D</b> .....             | 1 |
| Mobile Mounting Bracket <b>MMB-83</b> ..... | 1 |
| DC Power Cord w/Fuse.....                   | 1 |
| Spare Fuse 25A (USA/Asian version) .....    | 2 |
| Spare Fuse 20A (European version) .....     | 2 |
| Standing Foot .....                         | 2 |
| Operating Manual .....                      | 1 |

## Optional Accessories

|  |                 |
|--|-----------------|
| DTMF Microphone (equivalent to the supplied microphone)..... | <b>SSM-85D</b>  |
| Microphone.....  | <b>MH-42C6J</b> |
| Audio Signal Processing Unit .....                           | <b>SPU-1</b>    |
| High-Power External Speaker .....                            | <b>MLS-100</b>  |

## About this manual

This manual contains symbols and conventions to call attention to important information.

| Symbols   | Description  |
|---|--|
|  | This icon indicates cautions and information that should be read.            |
|  | This icon indicates helpful notes, tips and information that should be read. |

## Basic Operation

### Turning the Transceiver ON and OFF

Press and hold the  key to turn the transceiver **ON** / **OFF**.

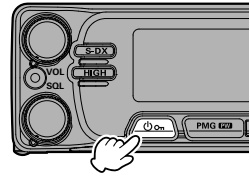

### Adjusting the volume

Rotate the **VOL** knob to adjust the volume to a comfortable level.

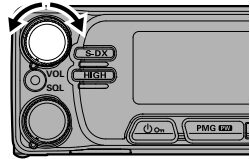

### Adjusting the squelch Setting

Rotate the **SQL** knob just to the point where the noise is silenced. If the **SQL** knob is set further clockwise, sensitivity to weak signals is reduced.

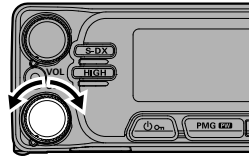

### Tuning to a Frequency

#### • DIAL knob

Rotating the **DIAL** knob allows tuning in the pre-programmed steps.

#### Change frequency in 1MHz steps

Press the **DIAL** knob, and then rotate the **DIAL** knob. Instead of pressing the **DIAL** knob, you may also press the **[A]** key on the Microphone's keypad to engage tuning in 1MHz steps.

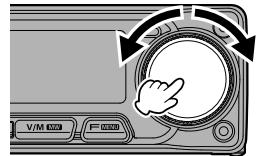

#### • The numeric keys on microphone

Press the numeric keys "0" to "9" to enter the frequency.

Example: To enter 145.520MHz

[1] → [4] → [5] → [5] → [2] → [0]

Example: To enter 145.000MHz

[1] → [4] → [5] → [Press and hold any numeric key]

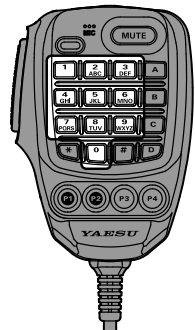

## Transmitting

1. While pressing and holding the **PTT**, speak into the microphone.
2. Release the **PTT** to return to receive.

- If the **PTT** switch is pressed when a frequency other than the amateur ham radio band is selected, an alarm tone (beep) will be emitted, “**Inhbt**” appears on the display, and transmit is disabled.



- If transmission is continued for a long period, the transceiver overheats, and the high temperature protection function is activated. As a result, the transmitting power level is automatically set to Low Power. If transmission continues while the high temperature protection function is active, the transceiver will be forcibly returned to the receive mode.

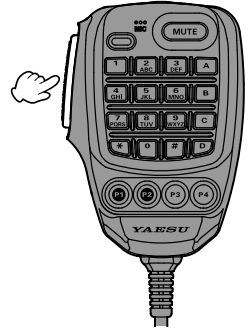

## Changing the Transmitter Power Level

Can be select from among a total of four transmit power levels on your **FT-3185R/E**.

To change the power level, press the **HIGH** key. These power levels will be stored, in memory registers, at the time of memory storage.

During transmission, the Bar Graph will deflect in the display, according to the power output selected

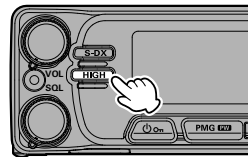

5 Watts

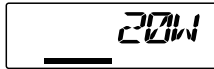

20 Watts



50 Watts



85 Watts

## Locking the Keys and DIAL knob

1. Press the **LOCK** key, “**LOCK**” is shown on the display for 2 second, the “**LOCK**” icon appears on the display, and then the keys and **DIAL** knob are locked.
2. Press the **LOCK** key again, “**UNLOCK**” will be shown on the Display and the keys and the **DIAL** knob are unlocked. The “**LOCK**” icon disappears.

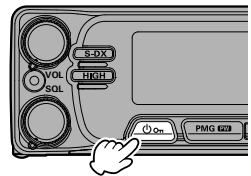

The **PTT** switch, VOL knob and SQL knob cannot be locked.

# New Features

## Function List

The Function List allows selecting 9 frequently used functions from the 44 different setup menus.

### Function List **Press the key**

|   |                                       |                                     |                                   |                                     |
|---|---------------------------------------|-------------------------------------|-----------------------------------|-------------------------------------|
| <b>F1 HOME</b><br>Recall the HOME channel | <b>F2 RPT.REV</b><br>Repeater Reverse | <b>F3 RPT.SFT</b><br>Repeater Shift | <b>F4 SQL.TYP</b><br>Squelch TYPE | <b>F5 TON.FRQ</b><br>TONE Frequency |
| <b>F6 DCS.COD</b><br>DCS Code             | <b>F7 xxxxxxxxx</b>                   | <b>F8 xxxxxxxxx</b>                 | <b>F9 xxxxxxxxx</b>               |                                     |

\*The "F1 HOME" to "F6 DCS.COD" are registered in the Function List by factory default.

The following 6 functions are registered in the Function List as the factory default settings:

|            |            |            |
|------------|------------|------------|
| F1 HOME    | F2 RPT.REV | F3 RPT.SFT |
| F4 SQL.TYP | F5 TON.FRQ | F6 DCS.COD |

### Set Up Menu **Press and hold the key**

|                   |                   |                         |                         |                   |
|-------------------|-------------------|-------------------------|-------------------------|-------------------|
| 01 APO            | 02 AR MOD         | 03 AR INT               | 04 BCLO                 | 05 BEEP           |
| 06 BELL           | 07 CLK.TYP        | 08 DIMMER               | 09 DTMF                 | 10 DT TX          |
| 11 DT MEM         | 12 DT DLY         | 13 DT SPD               | <b>14 HOME</b>          | 15 MCGAIN         |
| 16 PRG P1         | 17 PRG P2         | 18 PRG P3               | 19 PRG P4               | 20 PAG.CDR        |
| 21 PAG.CDT        | <b>22 RPT.REV</b> | <b>23 RPT.SFT</b>       | 24 RPT.ARS              | 25 RPT.FRQ        |
| 26 SCN.ON         | 27 SCN.RSM        | 28 DW RVT               | <b>29 SQL.TYP</b>       | <b>30 TON.FRQ</b> |
| <b>31 DCS.COD</b> | 32 DCS RV         | 33 SQL.EXP              | 34 TS MUT               | 35 TS SPD         |
| 36 STEP           | 37 TEMP           | 38 TOT                  | 39 TX PWR               | 40 VER.DSP        |
| 41 DC VLT         | 42 WIDTH          | 43 WX ALT <sup>**</sup> | 44 WX VOL <sup>**</sup> |                   |

<sup>\*\*</sup> USA version only.

The gray  setting items are registered in the Function List by factory default.



## Registering/Unregistering in the Function List

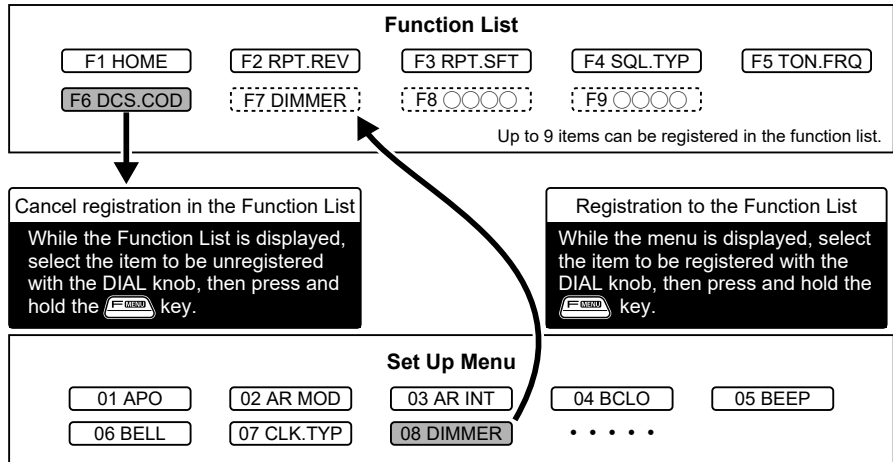

### • Setting functions using the function list

1. Press the **F-LOCK** key.  
The Function List is displayed.
2. Rotate the **DIAL** knob to select the desired function.
3. Press the **DIAL** knob to execute functions or change settings.

#### Close the function List

Press any key, the **DIAL** knob or the **PTT** switch to return to the previous screen.

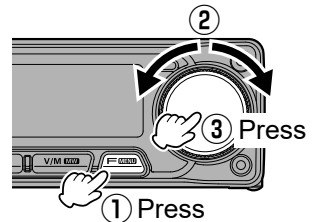

### • Setting functions using the Set Up Menu

1. Press and hold the **F-LOCK** key.  
The Setup Menu screen is displayed.
2. Rotate the **DIAL** knob to select the desired function.
3. Press the **DIAL** knob to execute functions or change settings.

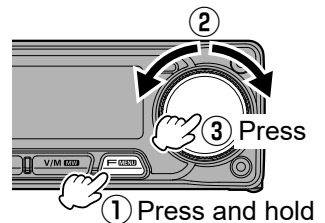

#### Close the Set Up Menu

Press any key, the **DIAL** knob or the **PTT** switch to return to the previous screen.



## New Features

### • Registration to the Function List

1. Press and hold the  key.  
The Setup Menu screen is displayed.
2. Rotate the **DIAL** knob to select the item to be registered in the Function List.
3. Press and hold the  key.  
The function is registered in the Function List.

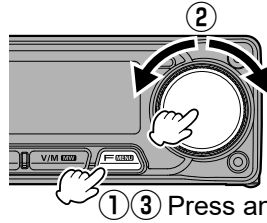

① ③ Press and hold



- The numbers “F1” to “F9” will be displayed in the upper left corner of the screen in the order they were registered.



- Up to 9 items can be registered in the Function List. If 9 items have already been registered, a beep will sound and additional functions cannot be entered. Before registering the new item, first unregister one item.



### • Cancel registration in the Function List

1. Press the  key.
2. Rotate the **DIAL** knob to select the registered item to cancel.
3. Press and hold the  key.  
The item will be deleted to return to the previous screen.

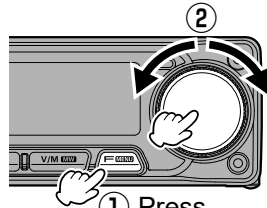

① Press  
③ Press and hold

## PMG (Primary Memory Group)

Register up to 5 channels to the Primary Memory Group, in advance. The registered channels may be scanned, and the channels with signals will be displayed with a bar graph.

**PMG Screen**

Press the **PMG** key.  
To scan the PMG channels.

Current Frequency  
146.520

P1 P2 P3 P4 P5

Current transmit/receive channel      PMG channel  
If there is a signal, a bar graph is displayed

Press the **PMG** key.  
To return to the screen displayed before the PMG screen.

- If there are no registered Channels in PMG, the PMG screen will not be displayed even if the **PMG** key is pressed.
- Press and hold the **V/M** key on the PMG screen. The contents of the currently selected PMG channel will be transferred to the VFO and the VFO mode is entered.
- Press and hold the **PMG** key on the PMG screen to unregister the currently selected PMG channel.
- Press the **V/M** key on the PMG screen to return to the VFO/Memory mode.

### Register the frequency to PMG

To register the frequency to PMG, display the VFO or memory channel, then press and hold the **PMG** key.

Up to 5 channels can be registered in PMG. When registering more than five Frequencies, older frequencies will be deleted in order from PMG.

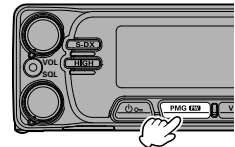

Press and hold

# New Features

## AUTO Mode The selected channel number is blinking

Scans PMG channels and automatically receives channels with signals. Resumes PMG scanning when the signal disappears. Transmit is automatically set to the receiving channel.

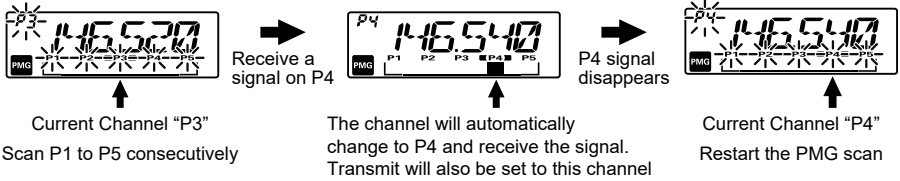

Press and hold the **DIAL** knob to switch AUTO and MANUAL Mode



## MANUAL Mode The selected channel number does not blink

Receives the signal of the channel selected with the **DIAL** knob. Transmit is also set to this channel. Reception status of other channels is displayed with the bar graph.

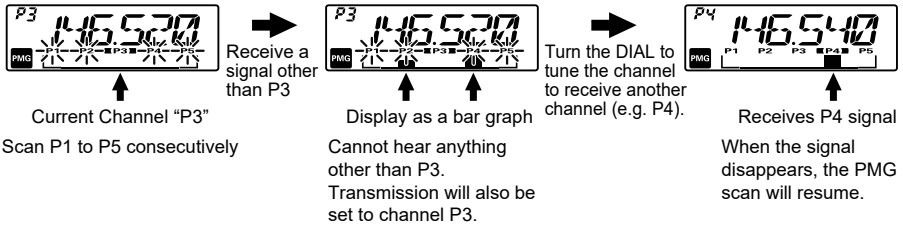

## Unregister a Channel (Frequency) from PMG

1. On the PMG screen, select the channel (frequency) to be unregistered by rotating the **DIAL** knob.
2. Press and hold the  key.

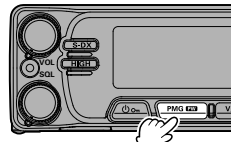

## Super DX plus Noise Cancelling

The Super DX function increases the sensitivity of the RF amplifier when the received signal is weak, expanding the calling range. In addition, by installing the optional “Signal Processing Unit SPU-1”, the received audio signal can be digitally processed to separate and remove noise. The voice can be enhanced to produce clearer, more comfortable sound quality. Even weak signals that were previously inaudible due to noise can now be received clearly.

Press the **S-DX** key to activate the Super DX function, the indicator on the right of the display will light white. (When the SPU-1 is installed, the **S-DX** key also turns the “Noise Canceling” function ON, and the indicator will light blue.)

Press the **S-DX** key again to return the receiver to normal sensitivity. The indicator light will turn OFF.

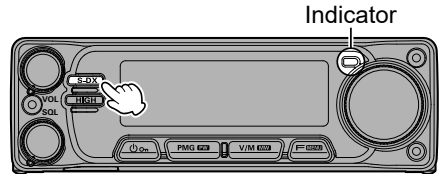

### • Installing the Audio Signal Processing Unit “SPU-1”

1. Turn the transceiver OFF.
2. Disconnect all the cables and the microphone from the transceiver.
3. Remove the six screws from the bottom cover.
4. Refer to the illustration for the mounting location of the SPU-1.  
Align the triangle marks and plug the SPU-1 toward the rear, all the way into the connector.
5. Fasten the SPU-1 into place using the two screws supplied with the SPU-1.  
Do not use incorrect screws, only use the supplied screws.
6. The SPU-1 installation is now complete.
7. Replace the top cover and secure it using the six screws.
8. Connect all the cables and the microphone to the transceiver.

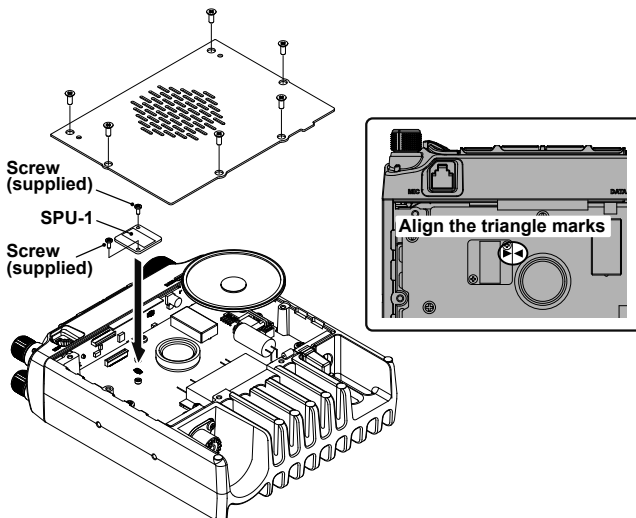

## Front and Rear Panel Controls & Switches

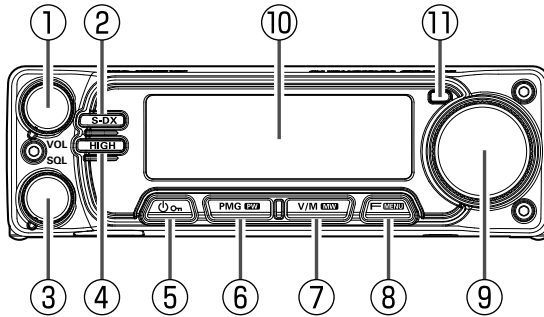

- ① **VOL Knob**  
Rotate the VOL Knob to adjust the audio volume level.
- ② **S-DX Key**  
Enable the Super DX function and increase sensitivity. Installation of the optional “SPU-1”, provides even greater noise reduction and clearer audio.
- ③ **SQL Knob**  
Rotate the SQL knob to adjust the squelch level. The squelch level may be adjusted to mute the background noise when no signal is present.
- ④ **HIGH Key**  
Press this key momentarily to select the transmit power (5W / 20W / 50W / 85W).
- ⑤ **Power Key**  
Press and hold this key to toggle the transceiver’s power ON and OFF.  
When the press this key to toggle the Lockout Feature “ON” or “OFF”.
- ⑥ **PMG 627 Key**  
Press this key momentarily to Displays PMG (Primary Memory Group).  
Press and hold in this key to Register the displayed frequency in PMG.
- ⑦ **V/M 6003 Key**  
Press this key momentarily to switch the frequency control among the VFO and Memory System.  
Press and hold in this key to activate the Memory Storage mode.
- ⑧ **F-MENU Key**  
Press this key to display the function list. Rotate the **DIAL** knob to select an item and perform the functions and make settings.  
Press and hold in this key to enter Setup Menu Mode.
- ⑨ **DIAL Knob**  
Change the frequency or select the memory channel. The microphone **[UP]/[DWN]** keys duplicate the functions of this knob.
  - In the VFO mode, press the **DIAL** knob to enable setting the operating frequency in 1MHz units.
  - In the memory mode, press the **DIAL** knob to fast-forward in 10 channel steps.

# Front and Rear Panel Controls & Switches

## 10 Display

The main digits on the display may show the operating frequency, memory name, or any of many parameters during Menu setup.

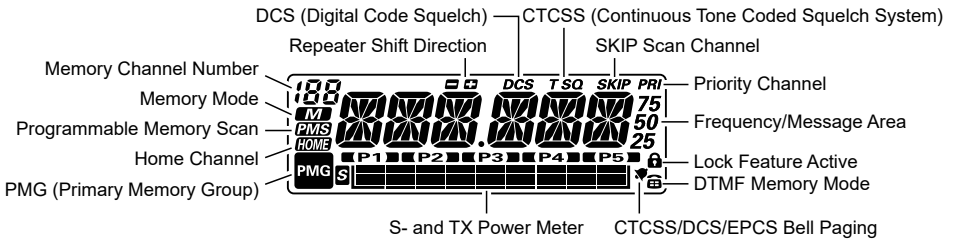

## 11 Mode indicator

The current operating mode is indicated by the color of the LED.

**Green:** RX

**Red:** TX

**White:** Super DX function

**Blue:** Super DX function (with SPU-1 installed)

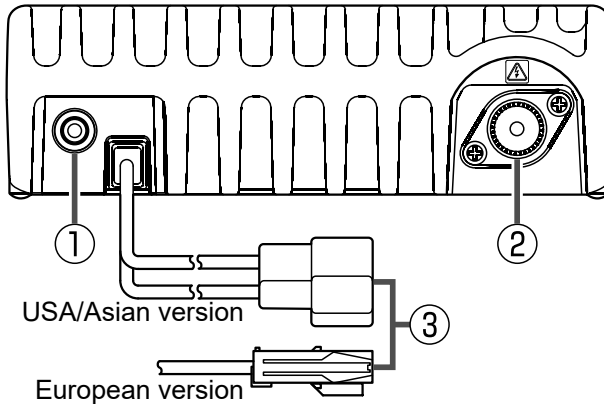

### 1 EXT SP Jack

This 2-contact 3.5-mm mini phone jack provides receiver audio output for an optional external speaker.

### 2 ANT Coaxial Socket

Connect the co-axial cable for the antenna.

### 3 13.8V DC Cable Pigtail

Connect the provided DC power supply cable (with fuse attached). The fuse is 25A (USA/Asian version) or 20A (European version).

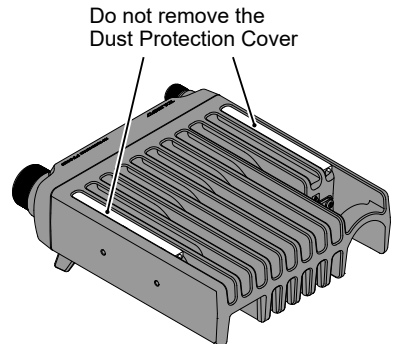

## Microphone Switches

### ① MIC

Speak into the microphone during transmission.

### ② TX LED

Lights red while pressing PTT switch.

### ③ PTT

Press and hold the PTT switch to transmit, and release it to receive.

### ④ DWN

Press this key to move the frequency or memory channel lower by one step, press and hold it to start scanning.

### ⑤ UP

Press this key to move the frequency or memory channel up by one step, press and hold it to start scanning.

### ⑥ MUTE

Press this key to mute the receive audio. Press it again to unmute the audio.

### ⑦ DTMF keypad

Press these keys during transmit to enter and send a DTMF sequence. The following operations can be performed during receive.

**0 - 9** : Enter the frequency or memory channel number.

**A** : VFO Mode: Change frequency in 1MHz steps

Memory mode: Change memory channel in 10 channel steps

**B** : This key has the same function as the  key on the Front Panel.

**C** : This key has the same function as the  key on the Front Panel.

**D** : This key has the same function as the  key on the Front Panel.

**\*** : No function assigned.

**#** : This key has the same function as the  key on the Front Panel.

### ⑧ Program keys (P1/P2/P3/P4)

The default function settings of the [P1] / [P2] / [P3] / [P4] keys are shown in the table below.

| Key | Function                        | Description                                    |
|-----|---------------------------------|--|
| P1  | SQL.OFF                         | Opens the squelch (SQL off)                    |
| P2  | HOME                            | Recalls the HOME channel                       |
| P3  | DW                              | Operation setting of dual receive function     |
| P4  | WX-CH (USA version)             | Switches operation to the Weather Channel Bank |
|     | T-CALL (European/Asian version) | Transmits the T-CALL (1750Hz)                  |

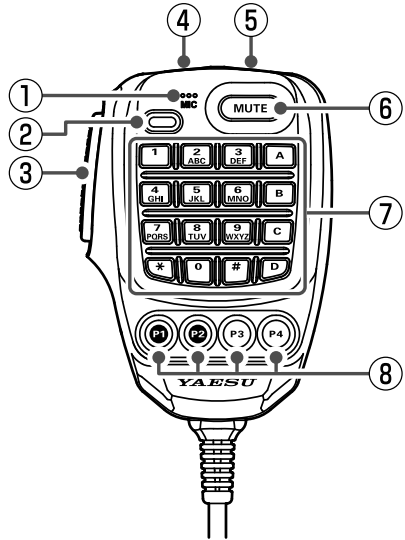



## Microphone Switches

The functions of the [P1] / [P2] / [P3] / [P4] keys can be assigned by the following operations:

1. Press and hold the  key.
2. Rotate the **DIAL** knob to select the Set mode Item to configure the desired microphone key:  
("16 PRG P1", "17 PRG P2", "18 PRG P3" or "19 PRG P4").
3. Press the **DIAL** knob.
4. Rotate the **DIAL** knob to select a function (see below) then press the **DIAL** knob.

**ARTS** : Engages the ARTS™ operation

**SCN ON** : Engages the Scan operation

**HOME** : Recall the HOME channel

**RPT.SFT** : Sets the repeater shift direction

**REV** : Reverses the transmit and receive frequencies in repeater mode

**TX PWR** : Selects the transmit power output level

**SQL.OFF** : Open the Squelch to allow un-muted reception

**T-CALL** : Activates 1750Hz Tone Burst

**DW** : Operation setting of dual receive function



**WX-CH** : Switches operation to the Weather Channel Bank (USA version only)

5. Press and hold the **DIAL** knob to save the new setting and exit to normal operation.





# Safety Precautions

Note beforehand that the company shall not be liable for any damages suffered by the customer or third parties in using this product, or for any failures and faults that occur during the use or misuse of this product, unless otherwise provided for under the law.







## Type and meaning of the marks

|   |  |
|---|--|
|  <b>DANGER</b>  | This symbol indicates the possibility of death or serious injury being inflicted on the user and the surrounding people when these instructions are ignored and the product is mishandled.                       |
|  <b>WARNING</b> | This symbol indicates the possibility of death or serious injury being inflicted on the user and the surrounding people when these instructions are ignored and the product is mishandled.                       |
|  <b>CAUTION</b> | This symbol indicates the possibility of physical impediments occurring or impediments being inflicted on the user and the surrounding people when these instructions are ignored and the product is mishandled. |











## Type and meaning of symbols

|   |  |
|---|--|
|  Prohibited actions that must not be attempted, in order to use this radio safely. For example,  signifies that disassembly is prohibited.   |  |
|  Precautions that must be adhered to in order to use this radio safely. For example,  signifies that the power supply is to be disconnected. |  |

## DANGER

|  |   |
|--|---|
|  <b>Do not use the device in “regions or aircrafts and vehicles where its use is prohibited” such as in hospitals and airplanes.</b><br>This may exert an impact on electronic and medical devices.                  |  <b>Never touch the antenna during transmission.</b><br>This may result in injury, electric shock and equipment failure.   |
|  <b>Do not use this product while driving or riding a motorbike. This may result in accidents.</b><br>Make sure to stop the car in a safe location first before use if the device is going to be used by the driver. |  <b>Do not transmit in crowded places in consideration of people who are fitted with medical devices such as heart pacemakers.</b><br>Electromagnetic waves from the device may affect the medical device, resulting in accidents caused by malfunctions.      |
|  <b>Do not operate the device when flammable gas is generated.</b><br>Doing so may result in fire and explosion.   |  <b>Do not touch any liquid leaking from the liquid display with your bare hands.</b><br>There is a risk of chemical burns occurring when the liquid comes into contact with the skin or gets into the eyes. In this case, seek medical treatment immediately. |

## WARNING

|   |   |
|---|---|
|  <b>Do not use voltages other than the specified power supply voltage.</b><br>Doing so may result in fire and electric shock.   |  <b>Keep the power plug pins and the surrounding areas clean at all times.</b><br>This may result in fire, liquid leak, overheating, breakage, ignition etc.                                 |
|  <b>Do not transmit continuously for long periods of time.</b><br>This may cause the temperature of the main body to rise and result in burns and failures due to overheating.  |  <b>Disconnect the power cord and connection cables before incorporating items sold separately and replacing the fuse.</b><br>This may result in fire, electric shock and equipment failure. |
|  <b>Do not dismantle or modify the device.</b><br>This may result in injury, electric shock and equipment failure.  |  <b>Never cut off the fuse holder of the DC power cord.</b><br>This may cause short-circuiting and result in ignition and fire.  |
|  <b>Do not handle the power plug and connector etc. with wet hands. Also do not plug and unplug the power plug with wet hands.</b><br>This may result in injury, liquid leak, electric shock and equipment failure.   |  <b>Do not use fuses other than those specified.</b><br>Doing so may result in fire and equipment failure.   |
|  <b>When smoke or strange odors are emitted from the radio, turn off the power and disconnect the power cord from the socket.</b><br>This may result in fire, liquid leak, overheating, damage, ignition and equipment failure. Please contact our company amateur customer support or the retail store where you purchased the device. |  <b>Do not allow metallic objects such as wires and water to get inside the product.</b><br>This may result in fire, electric shock and equipment failure.                                   |

## Safety Precautions



**Do not place the device in areas that may get wet easily (e.g. near a humidifier).**  
This may result in fire, electric shock and equipment failure.



**When connecting a DC power cord, pay due care not to mix up the positive and negative polarities.**  
This may result in fire, electric shock and equipment failure.



**Do not use DC power cords other than the one enclosed or specified.**  
This may result in fire, electric shock and equipment failure.



**Do not bend, twist, pull, heat and modify the power cord and connection cables in an unreasonable manner.**  
This may cut or damage the cables and result in fire, electric shock and equipment failure.



**Do not pull the cable when plugging and unplugging the power cord and connection cables.**  
Please hold the plug or connector when unplugging. If not, this may result in fire, electric shock and equipment failure.



**Refrain from using headphones and earphones at a loud volume.**  
Continuous exposure to loud volumes may result in hearing impairment.



**Do not use the device when the power cord and connection cables are damaged, and when the DC power connector cannot be plugged in tightly.**  
Please contact YAESU Technical Support or the retail store where you purchased the device as this may result in fire, electric shock and equipment failure.



**Follow the instructions given when installing items sold separately and replacing the fuse.**  
This may result in fire, electric shock and equipment failure.



## CAUTION



**Do not place this device near a heating instrument or in a location exposed to direct sunlight.**  
This may result in deformation and discoloration.



**Do not place this device in a location where there is a lot of dust and humidity.**  
Doing so may result in fire and equipment failure.



**Stay as far away from the antenna as possible during transmission.**  
Long-term exposure to electromagnetic radiation may have a negative effect on the human body.



**Do not wipe the case using thinner and benzene etc.**  
Please use a soft and dry piece of cloth to wipe away the stains on the case.



**Keep out of the reach of small children.**  
If not, this may result in injuries to children.



**Do not put heavy objects on top of the power cord and connection cables.**  
This may damage the power cord and connection cables, resulting in fire and electric shock.



**Do not transmit near the television and radio.**  
This may result in electromagnetic interference.



**Do not use optional products other than those specified by our company.**  
If not, this may result in equipment failure.



**When using the device in a hybrid car or fuel-saving car, make sure to check with the car manufacturer before using.**  
The device may not be able to receive transmissions normally due to the influence of noises from the electrical devices (inverters etc.) fitted in the car.



**For safety reasons, switch off the power and pull out the DC power cord connected to the DC power connector when the device is not going to be used for a long period of time.**  
If not, this may result in fire and overheating.



**Do not throw or subject the device to strong impact forces.**  
This may result in equipment failure.



**Do not put this device near magnetic cards and video tapes.**  
The data in the cash card and video tape etc. may be erased.



**Do not turn on the volume too high when using a headphone or earphone.**  
This may result in hearing impairment.



**Do not place the device on an unsteady or sloping surface, or in a location where there is a lot of vibration.**  
The device may fall over or drop, resulting in fire, injury and equipment failure.



**Do not stand on top of the product, and do not place heavy objects on top or insert objects inside it.**  
If not, this may result in equipment failure.



**Do not use a microphone other than those specified when connecting a microphone to the device.**  
If not, this may result in equipment failure.



**Do not touch the heat radiating parts.**  
When used for a long period of time, the temperature of the heat radiating parts will get higher, resulting in burns when touched.



**Do not open the case of the product except when replacing the fuse and when installing items sold separately.**  
This may result in injury, electric shock and equipment failure.

# Installation

## About the Antenna

The antenna is an extremely important part for both transmitting and receiving. The antenna type and its inherent characteristics determine whether the performance of the transceiver can be fully realized. As such, please note the following:

- Use an antenna that is suitable for the operating frequency band.
- Use an antenna and a coaxial cable with a characteristic feed point impedance of  $50\Omega$ .
- Adjust the VSWR (Voltage Standing Wave Ratio) until it is 1.5 or less for an antenna with an adjusted impedance of  $50\Omega$ .
- Keep the coaxial cable routing length as short as possible.

## Connection of Antenna and Power Cables

Please follow the outline in the illustration regarding the proper connection of antenna coaxial cables and Power Supply.

### Cautions

- **Do not use a DC power supply cable other than the one that is provided.**
- **Do not use the DC power supply cable with the fuse holder cut off.**
- **Use an external power source capable of supplying DC 13.8V, a current capacity of 20A or more.**



High RF voltage is present in the TX RF section of the transceiver while transmitting. Absolutely! Do not touch the TX RF section while transmitting.



Permanent damage can result when improper supply voltage, or reverse polarity voltage, is applied to the **FT-3185R/E**. The Limited Warranty on this transceiver does not cover damage caused by application of AC voltage, reverse polarity DC, or DC voltage outside the specified range of  $13.8V \pm 15\%$ . When replacing fuses, be certain to use a fuse of the proper rating. The **FT-3185R/E** requires a 25 Amp (USA/Asian version) or 20 Amp (European version) blade fuse.

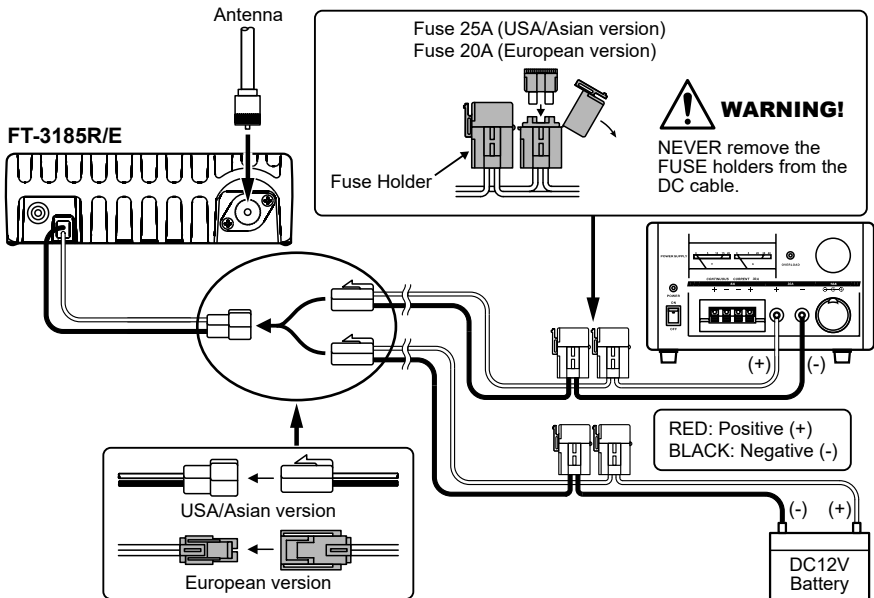

## Installing the Transceiver

The **FT-3185R/E** must only be installed in vehicles having a 13.8 Volt negative ground electrical system. Mount the transceiver where the display, controls, and microphone are easily accessible, using the supplied **MMB-83** mounting bracket.

The transceiver may be installed in almost any location, but should not be positioned near a heating vent nor anywhere where it might interfere with driving (either visually or mechanically). Make sure to provide plenty of space on all sides of the transceiver so that air can flow freely around the transceiver's case. Refer to the diagrams showing proper installation procedures.

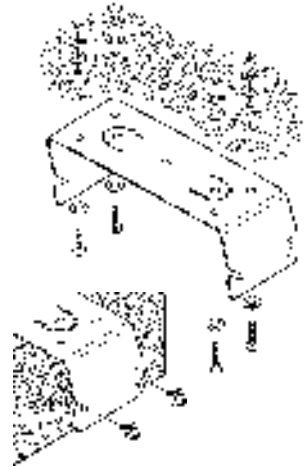

## Installing the Microphone

Insert the microphone plug into the recessed jack on the transceiver, as shown in the illustration.

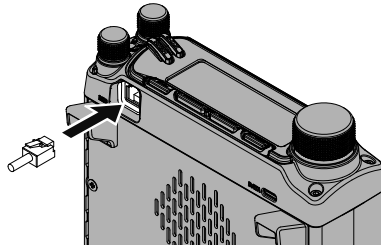

## Base Station Feet

The supplied Base Station Feet allow the transceiver to be tilted upward for better viewing. To install the Base Station Feet, remove the two screws affixing the front side of the bottom cover, then install the Base Station Feet using these screws.

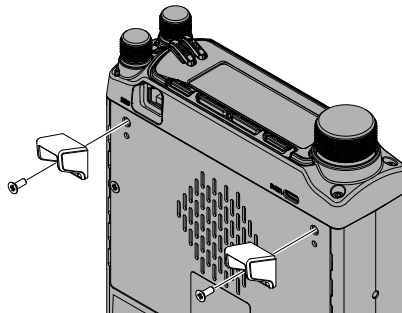

## Advanced Operation

### Weather Broadcast Reception (USA version only)

The **FT-3185R** includes a unique feature which allows reception of weather broadcasts in the 160MHz frequency range. Ten standard Weather Broadcast channels are pre-loaded into a special memory bank.

To listen to a Weather Broadcast Channel:

1. Press the Microphone's **[P4]** key to recall the Weather Broadcast channels.
2. Turn the **DIAL** knob to select the desired Weather Broadcast channel.

| CH | Frequency  | CH | Frequency  |
|----|------------|----|------------|
| 01 | 162.550MHz | 06 | 162.500MHz |
| 02 | 162.400MHz | 07 | 162.525MHz |
| 03 | 162.475MHz | 08 | 161.650MHz |
| 04 | 162.425MHz | 09 | 161.775MHz |
| 05 | 162.450MHz | 10 | 163.275MHz |

3. If you wish to check the other channels for activity by scanning, just press the Microphone's **PTT** switch.
4. To exit to normal operation, press the **[P4]** key again. Operation will return to the VFO or Memory channel you were operating on before you began Weather Broadcast operation.



The **[P4]** key, one of the programmable keys, is assigned (default setting) as the "WX Broadcast" one-touch access key. Please note that if you change/assign another function to the **[P4]** key, one-touch access to the WX channel will be unavailable.



### • Severe Weather Alert Feature

In the event of extreme weather disturbances, such as storms and hurricanes, NOAA (the National Oceanic and Atmospheric Administration) sends a weather alert accompanied by a 1050Hz tone and subsequent weather report on one of the NOAA weather channels. You may enable this feature via Menu Item "**43 WX ALT**", if desired.

When scanning the band or the "regular" memories, with the Severe Weather Alert feature engaged, you will notice that the **FT-3185R** will break over to the Weather Channel bank every five seconds, performing a quick scan of those channels in search for the 1050Hz alert tone. If the alert tone is received, operation will lock on the weather broadcast station issuing the alert; otherwise, the transceiver will revert to the VFO or memory scan session in progress without interruption.

When the alert tone is received, press the **PTT** switch momentarily to disable the alarm, and the Severe Weather message will now be audible from the speaker.

## LOCK Feature

To activate the locking feature, press the  key. The “” icon will appear on the LCD.

To cancel locking, press the  key again.

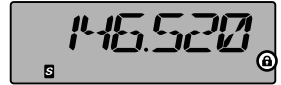

## Keyboard Beeper

A key beeper provides useful audible feedback whenever a key is pressed. If you want to turn the beeper off (or back on again):

1. Press and hold the  key, then rotate the **DIAL** knob to select “**05 BEEP**”.
2. Press the **DIAL** knob, then rotate the **DIAL** knob to set the display to “OFF”.
3. Press and hold the **DIAL** knob to save the new setting and exit to normal operation.
4. To turn the beep back on again, select “LOW (factory default)” or “HIGH” in step 2 above.

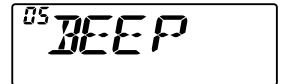
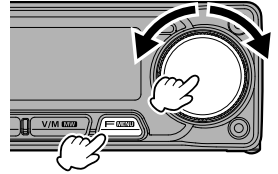

## Channel Step Selection

Tuning steps are factory preset to default increments which are appropriate for the country to which this transceiver is exported. You may have a reason to use a different step size, however, and here is the procedure for changing the channel steps:

1. Press and hold the  key, then rotate the **DIAL** knob to select “**36 STEP**”.
2. Press the **DIAL** knob, then rotate the **DIAL** knob to select the desired step size (AUTO/ 5 / 6.25 / 10 / 12.5 / 15 / 20 / 25 / 50 / 100 kHz).
3. Press and hold the **DIAL** knob to save the new setting and exit to normal operation.

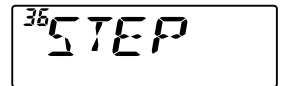
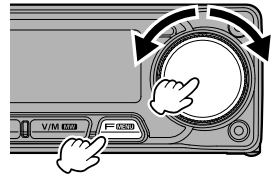

## Display Brightness

The **FT-3185R/E** display illumination has been specially engineered to provide high visibility with minimal disruption of your “night vision” while you are driving. The brightness of the display is manually adjustable, using the following procedure:

1. Press and hold the  key, then rotate the **DIAL** knob to select “**08 DIMMER**”.
2. Press the **DIAL** knob, then rotate the **DIAL** knob to select the comfortable brightness level (OFF / MID / MAX).
3. Press and hold the **DIAL** knob to save the new setting and exit to normal operation.

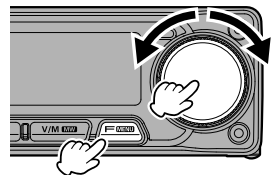

## Repeater Operation

The **FT-3185R/E** includes an ARS (Automatic Repeater Shift) function which automatically sets the repeater operation when the receiver is tuned to the repeater frequency.

1. Set the receive frequency to the repeater frequency “**□**” or “**□**” icon appears on top of the display.
2. Speak into the microphone while pressing and holding the **PTT** switch.

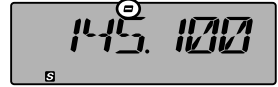

## Reverse function

The “reverse” state temporarily reverses the transmit and receive frequencies. This allows checking to find if direct communication with the other station is possible.

1. Press the **F LIST** key.
2. Rotate the **DIAL** knob to select “**22 RPT.REV**”, then press the **DIAL** knob.

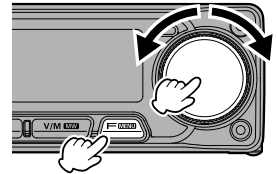

In the factory default setting, “**22 RPT.REV**” is registered in the “Function List” that is displayed when the **F LIST** key is pressed.

- The transmit and receive frequencies are temporarily reversed (“reverse” state).
  - In the “reverse” state, the “**□**” or “**□**” blinks on the display.
3. To release the reverse state, repeat the above steps again.

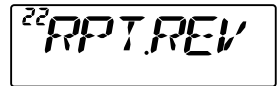

- The repeater settings may be changed from the Menu list.  
Function or Menu list “**23 RPT.SFT**”: Allows setting the repeater shift direction.  
Menu list “**24 RPT.ARS**”: The ARS function may be set to OFF  
Menu list “**25 RPT.FRQ**”: Allows changing the repeater shift offset.
- Menu list “**30 TON.FRQ**”: CTCSS Tone frequency

## Tone Calling (1750Hz)

If the transceiver is **FT-3185E** (European version), press and hold the [**P4**] key on the microphone (in factory default setting) to generate a 1750 Hz burst tone to access the European repeater. The transmitter will automatically be activated, and a 1750Hz audio tone will be superimposed on the carrier. Once access to the repeater has been achieved, release the switch, and thereafter use the switch for activating the transmitter. To access repeaters which require a 1750Hz burst tone with the **FT-3185R** (USA/Asian versions), set the program key on the microphone to serve as a “**T-CALL**” key. To change the configuration of this switch, use menu list “**16 PRG P1**”, “**17 PRG P2**”, “**18 PRG P3**” or “**19 PRG P4**”.



## CTCSS Operation

Many repeater systems require that a very-low-frequency audio tone be superimposed on your FM carrier in order to activate the repeater. This helps prevent false activation of the repeater by radar or spurious signals from other transmitters. This tone system, called “CTCSS” (Continuous Tone Coded Squelch System), is included in your **FT-3185R/E**, and is very easy to activate.

**i** CTCSS setup involves two actions: setting the Tone Mode and then setting of the Tone Frequency. These actions are set up by using the Setup Menu mode, selections “**29 SQL.TYP**” and “**30 TON.FRQ**”.

1. Press and hold the  key, then rotate the **DIAL** knob to select “**29 SQL.TYP**”.

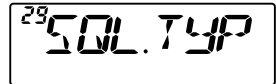

2. Press the **DIAL** knob, then rotate the **DIAL** knob so that “TONE” appears on the display; this activates the CTCSS Encoder, which allows repeater access.
3. Rotating the **DIAL** knob one more click clockwise in the above step will cause “TON.SQL” to appear. When “TON.SQL” appears, this means that the Tone Squelch system is active, which mutes your **FT-3185R/E**'s receiver until it receives a call from another radio sending out a matching CTCSS tone. This can help keep your radio quiet until a specific call is received, which may be helpful while operating in congested areas.

**i** You may notice a “RV TON” indication on the display while you rotate the **DIAL** knob in this step; this means that the Reverse Tone Squelch system is active, which mutes your **FT-3185R/E**'s receiver (instead of opening the squelch) when it receives a call from the transceiver sending a matched CTCSS tone. The “T SQ” icon will blink on the display when the Reverse Tone Squelch system is activated.

4. When you have made your selection of the CTCSS tone mode, press the **DIAL** knob momentarily, then rotate the **DIAL** knob one more click clockwise to select Menu “**30 TON.FRQ**”. This Menu selection allows setting of the CTCSS tone frequency to be used.

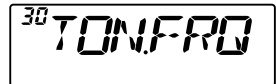

5. Press the **DIAL** knob momentarily to enable the adjustment of the CTCSS frequency.
6. Rotate the **DIAL** knob to select the desired Tone Frequency.

| CTCSS TONE FREQUENCY (Hz) |       |       |       |       |       |       |       |       |       |       |       |       |
|---------------------------|-------|-------|-------|-------|-------|-------|-------|-------|-------|-------|-------|-------|
| 67.0                      | 69.3  | 71.9  | 74.4  | 77.0  | 79.7  | 82.5  | 85.4  | 88.5  | 91.5  | 94.8  | 97.4  | 100.0 |
| 103.5                     | 107.2 | 110.9 | 114.8 | 118.8 | 123.0 | 127.3 | 131.8 | 136.5 | 141.3 | 146.2 | 151.4 | 156.7 |
| 159.8                     | 162.2 | 165.5 | 167.9 | 171.3 | 173.8 | 177.3 | 179.9 | 183.5 | 186.2 | 189.9 | 192.8 | 196.6 |
| 199.5                     | 203.5 | 206.5 | 210.7 | 218.1 | 225.7 | 229.1 | 233.6 | 241.8 | 250.3 | 254.1 | -     | -     |

7. Press and the **DIAL** knob to save the new setting and exit to normal operation.

**i** Press the **DIAL** knob momentarily as described in procedure “6”. You can now set the transmit CTCSS frequency. “**T**” is displayed at the right of the CTCSS frequency indication. Rotate the **DIAL** knob until the desired CTCSS frequency is displayed. Press the **DIAL** knob again to save the new setting and return to the previous screen.



# CTCSS/DCS/EPCS Operation

## DCS Operation

Another form of tone access control is Digital Code Squelch, or DCS. It is a newer, more advanced tone system which generally provides more immunity from false paging than does CTCSS. The DCS Encoder/Decoder is built into your **FT-3185R/E**, and operation is very similar to that just described for CTCSS. Your repeater system may be configured for DCS; if not, it is frequently quite useful in Simplex operation if your friend(s) use transceivers equipped with this advanced feature.

**i** Just as in CTCSS operation, DCS requires that you set the Tone Mode to DCS and that you select a Tone Code.

1. Press and hold the  key, then rotate the **DIAL** knob to select "**29 SQL.TYP**".
2. Press the **DIAL** knob, then rotate the **DIAL** knob until "DCS" appears on the display; this activates the DCS Encoder/Decoder.
3. Now press the **DIAL** knob momentarily, then rotate the **DIAL** knob to select Menu "**31 DCS.COD**".
4. Press the **DIAL** knob momentarily to enable the adjustment of the DCS code.
5. Rotate the **DIAL** knob to select the desired DCS Code (a three-digit number).

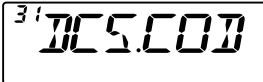
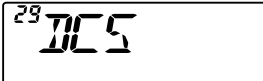
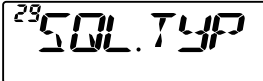

4. Press the **DIAL** knob momentarily to enable the adjustment of the DCS code.
5. Rotate the **DIAL** knob to select the desired DCS Code (a three-digit number).

| DCS CODE |     |     |     |     |     |     |     |     |     |     |     |     |     |     |
|----------|-----|-----|-----|-----|-----|-----|-----|-----|-----|-----|-----|-----|-----|-----|
| 023      | 025 | 026 | 031 | 032 | 036 | 043 | 047 | 051 | 053 | 054 | 065 | 071 | 072 | 073 |
| 074      | 114 | 115 | 116 | 122 | 125 | 131 | 132 | 134 | 143 | 145 | 152 | 155 | 156 | 162 |
| 165      | 172 | 174 | 205 | 212 | 223 | 225 | 226 | 243 | 244 | 245 | 246 | 251 | 252 | 255 |
| 261      | 263 | 265 | 266 | 271 | 274 | 306 | 311 | 315 | 325 | 331 | 332 | 343 | 346 | 351 |
| 356      | 364 | 365 | 371 | 411 | 412 | 413 | 423 | 431 | 432 | 445 | 446 | 452 | 454 | 455 |
| 462      | 464 | 465 | 466 | 503 | 506 | 516 | 523 | 526 | 532 | 546 | 565 | 606 | 612 | 624 |
| 627      | 631 | 632 | 654 | 662 | 664 | 703 | 712 | 723 | 731 | 732 | 734 | 743 | 754 | -   |

6. Press and the **DIAL** knob to save the new setting and exit to normal operation.
  - 1) Remember that the DCS is an Encode/Decode system, so your receiver will remain muted until a matching DCS code is received on an incoming transmission. Switch the DCS off when you're just tuning around the band.
  - 2) Press the **DIAL** knob momentarily as described in procedure "5". You can now set the transmit DCS code. "T" is displayed at the right of the DCS code indication. Rotate the **DIAL** knob until the desired DCS code is displayed. Press the **DIAL** knob again to save the new setting and return to the previous screen.

**i**



## Tone Search Scanning

In operating situations where you don't know the CTCSS tone or DCS code being used by another station or stations, you can command the transceiver to listen to the incoming signal and scan in search of the tone being used. Two things must be remembered in this regard:

- You must be sure that your repeater uses the same tone type (CTCSS vs. DCS).
- Some repeaters do not pass the CTCSS tone or DCS code; you may have to listen to the station(s) transmitting on the repeater uplink (input) frequency in order to allow Tone Search Scanning to work.

To scan for the tone in use:

1. Set the transceiver up for either CTCSS or DCS Decoder operation (see the previous discussion). In the case of CTCSS, "T SQ" will appear on the display; in the case of DCS, "DCS" will appear on the display.
2. Press and hold the  key, then rotate the **DIAL** knob to select "**30 TON.FRQ**" or "**31 DCS.COD**".
3. Press the **DIAL** knob.
4. Press and hold the Microphone's **[UP]** or **[DWN]** key to start scanning for the incoming CTCSS or DCS tone/code.
5. When the transceiver detects the correct tone or code, it will halt on that tone/code, and audio will be allowed to pass.
6. Press the Microphone's **[UP]** / **[DWN]** key or **PTT** switch momentarily to lock in that tone/code.



---

If the Tone Scan feature does not detect a tone or code, it will continue to scan indefinitely. When this happens, it may be that the other station is not sending any tone. You can press the Microphone's **[UP]** / **[DWN]** key or **PTT** switch to halt the scan at any time.

---

You may listen to the (muted) signals from the other stations during Tone Scanning when Set Mode Item "**34 TS MUT**" is set to "OFF". You can also change the Tone Search scanning speed, using Set Mode Item "**35 TS SPD**".

Tone Scanning works either in the VFO or Memory mode.

# CTCSS/DCS/EPCS Operation





## EPCS (Enhanced Paging & Code Squelch) Operation

The FT-3185R/E includes an Enhanced CTCSS tone encoder/decoder and a dedicated microprocessor providing paging and selective calling features. This allows you to place a call to a specific station (Paging), and to receive calls of your choice directed only to you (Code Squelch).

The paging and code squelch systems use two pairs of (alternately switched) CTCSS tones which are stored in the pager memories. Basically, your receiver remains silent until it receives the CTCSS tone pair that matches those stored in the Receiving Pager Memory. The squelch then opens so the caller is heard, and the paging ringer immediately sounds, if activated. When you close the **PTT** switch to transmit, the CTCSS tone pair which is stored in the Transmitting Pager Memory will be transmitted automatically.

On the paged transceiver, the squelch will close automatically after the incoming page ends.

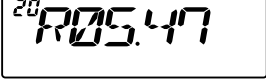
### • Storing the CTCSS Tone Pairs for EPCS Operation

1. Press and hold the  key to enter the Set mode.
2. Rotate the **DIAL** knob to select “**20 PAG.CDR**” for the Receiving CTCSS Tone Pair or “**21 PAG.CDT**” for the Transmitting CTCSS Tone Pair.  

3. Press the **DIAL** knob to enable adjustment of this Set Mode Item.  

4. Rotate the **DIAL** knob to set the CTCSS Tone number which corresponds to the first tone of the CTCSS Tone Pair.  

5. Press the **DIAL** knob, then rotate the **DIAL** knob to set the CTCSS Tone number which corresponds to the second tone of the CTCSS Tone Pair.
6. Press the **DIAL** knob to save the new setting.
7. Press the  key exit to normal operation.

 The FT-3185R/E does not recognize the order of the 1st tone and the 2nd tone. In other words, for example, the FT-3185R/E considers both CTCSS pairs “10, 35” and “35, 10” to be identical.

CTCSS Tone Number

| No. | Hz   | No. | Hz    | No. | Hz    | No. | Hz    | No. | Hz    |
|-----|------|-----|-------|-----|-------|-----|-------|-----|-------|
| 01  | 67.0 | 11  | 94.8  | 21  | 131.8 | 31  | 171.3 | 41  | 203.5 |
| 02  | 69.3 | 12  | 97.4  | 22  | 136.5 | 32  | 173.8 | 42  | 206.5 |
| 03  | 71.9 | 13  | 100.0 | 23  | 141.3 | 33  | 177.3 | 43  | 210.7 |
| 04  | 74.4 | 14  | 103.5 | 24  | 146.2 | 34  | 179.9 | 44  | 218.1 |
| 05  | 77.0 | 15  | 107.2 | 25  | 151.4 | 35  | 183.5 | 45  | 225.7 |
| 06  | 79.7 | 16  | 110.9 | 26  | 156.7 | 36  | 186.2 | 46  | 229.1 |
| 07  | 82.5 | 17  | 114.8 | 27  | 159.8 | 37  | 189.9 | 47  | 233.6 |
| 08  | 85.4 | 18  | 118.8 | 28  | 162.2 | 38  | 192.8 | 48  | 241.8 |
| 09  | 88.5 | 19  | 123.0 | 29  | 165.5 | 39  | 196.6 | 49  | 250.3 |
| 10  | 91.5 | 20  | 127.3 | 30  | 167.9 | 40  | 199.5 | 50  | 254.1 |

## • Activating the Enhanced Paging & Code Squelch System

1. Press and hold the  key, then rotate the **DIAL** knob to select “**29 SQL.TYP**”.



2. Press the **DIAL** knob, then rotate the **DIAL** knob to set the display to “**PAGER**”.

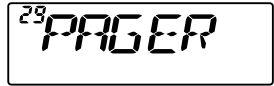

3. Press and hold the **DIAL** knob to save the new setting and exit to normal operation.

## CTCSS/DCS/EPCS Bell Operation

During CTCSS Decode, DCS, or EPCS operation, you may set up the **FT-3185R/E** such that a ringing “bell” sound alerts you to the fact that a call is coming in. Here is the procedure for activating the CTCSS/DCS/EPCS Bell:

1. Set the transceiver up for CTCSS Decode (“Tone Squelch”), DCS, or EPCS operation, as described previously.
2. Adjust the operating frequency to the desired channel.

3. Press and hold the  key, then rotate the **DIAL** knob to select “**6 BELL**”.

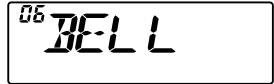

4. Rotate the **DIAL** knob to set the desired number of rings of the Bell. The available choices are 1, 3, 5, or 8 rings, CONTI (continuous ringing), or OFF.
5. Press and hold the **DIAL** knob to save the new setting and exit to normal operation.

When you are called by a station whose transceiver is sending a CTCSS tone, DCS code, or CTCSS code pair which matches that set into your Decoder, the Bell will ring in accordance with this programming.

When the CTCSS/DCS/EPCS Bell is activated, the “” icon will appear on the display.

## Split Tone Operation

The **FT-3185R/E** can be operated in a “Split Tone” configuration, to enable operation on repeaters using a mix of both CTCSS and DCS control via the Set mode.

1. Press and hold the  key, then rotate the **DIAL** knob to select “**33 SQL.EXP**”.



2. Press the **DIAL** knob, then rotate the **DIAL** knob to set this Menu item to “ON” (to enable the Split Tone feature).
3. Press and hold the **DIAL** knob to save the new setting and exit to normal operation.

When the Split Tone feature is activated, you can see the following additional parameters following the “PAGER” parameter (while selecting the tone mode by Set mode item “**29 SQL.TYP**”):

D CODE: DCS Encode only (the “**DCS**” icon will blink during operation)

T DCS: Encodes a CTCSS Tone and Decodes a DCS code  
(the “**T**” icon will blink and the “**DCS**” icon will appear during operation)

D TONE: Encodes a DCS code and Decodes a CTCSS Tone  
(the “**T SQ**” icon will appear and “**DCS**” icons will blink during operation)

Select the desired operating mode from the selections shown above.

## DTMF Operation

The Microphone's 16-button keypad allows easy DTMF dialing for Autopatch, repeater control, or Internet-link access purposes. Besides numerical digits [0] through [9], the keypad includes the [\*] and [#] digits, plus the [A], [B], [C], and [D] tones often used for repeater control.

### Manual DTMF Tone Generation

You can generate DTMF tones during transmission manually.

1. Press and hold the  key, then rotate the **DIAL** knob to select “9 DTMF”.
2. Press the **DIAL** knob, then rotate the **DIAL** knob to set this Set Mode Item to “MANUAL” (thus enabling the Manual DTMF Tone Generation).
3. Press and hold the **DIAL** knob to save the new setting and exit to normal operation.
4. Press the **PTT** switch to begin transmission.
5. While transmitting, press the desired numbers on the keypad.
6. When you have sent all the digits desired, release the **PTT** switch.

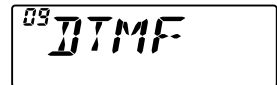
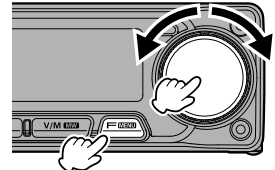



### DTMF Autodialer

Nine DTMF Autodialer memories are available on the **FT-3185R/E**. These DTMF Autodialer memories can store up to 16 digits of a telephone number for repeater autopatch or other use.

#### • Registering the DTMF memory

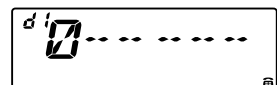
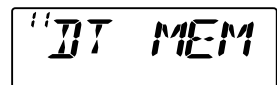
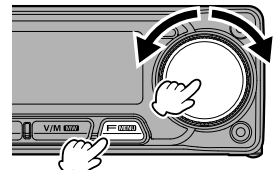
1. Press and hold the  key, then rotate the **DIAL** knob to select “11 DT MEM”.
2. Press the **DIAL** knob, then rotate the **DIAL** knob to select the DTMF Autodialer memory channel number into which you wish store a telephone number (“d1” to “d9”).
3. Press the **DIAL** knob momentarily, then rotate the **DIAL** knob to select the first digit of the telephone number you wish to store.
4. When you have selected the correct digit, press the **DIAL** knob momentarily. Now, rotate the **DIAL** knob to select the second of 16 available numbers in the current DTMF Autodialer memory register.



5. Repeat this procedure for each digit in the telephone number. If you a mistake, press the  key to move back to the left digit, then re-enter the correct number.
6. When entry of all digits is complete, press and hold the **DIAL** knob.
7. If you wish to store another DTMF string, repeat steps 2 through 6 above.
8. Press and hold the **DIAL** knob to save the new setting and exit to normal operation.

## • Transmitting the registered DTMF code

1. Press and hold the  key, then rotate the **DIAL** knob to select “**09 DTMF**”.
2. Press the **DIAL** knob, then rotate the **DIAL** knob to set this Set Mode Item to “**AUTO**”.
3. Press and hold the **DIAL** knob to save the new setting and exit to normal operation.
4. In the Autodialer mode, which you just engaged, first press the **PTT** switch, then press the microphone’s numeric key ([1] through [9]) corresponding to the DTMF memory string you wish to send. Once the string begins, you may release the **PTT** switch, as the transmitter will be held “on the air” until the DTMF string is completed.

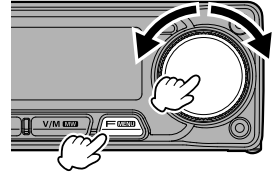

While the DTMF Autodialer is activated, the “” icon will appear on the LCD.

To disable the Autodialer function mode, select “**MANUAL**” in step 2 above.

The speed at which the DTMF digits are sent can be changed. Two speed levels are available: Low (10 digits per second) and High (20 digits per second: default). To toggle between Low and High speed, use the following procedure:

1. Press and hold the  key, then rotate the **DIAL** knob to select “**13 DT SPD**”.
2. Press the **DIAL** knob, then rotate the **DIAL** knob to select the desired speed (“50MS”: High speed or “100MS”: Low speed).
3. Press and hold the **DIAL** knob to save the new setting and exit to normal operation.

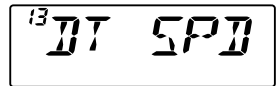
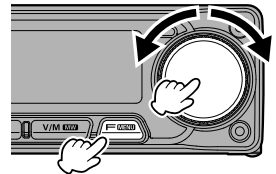

You can also set a longer delay between the time your transmitter is keyed and the first DTMF digit is sent. To set the delay time, use the following procedure:

1. Press and hold the  key, then rotate the **DIAL** knob to select “**12 DT DLY**”.
2. Press the **DIAL** knob, then rotate the **DIAL** knob to select the desired speed (50MS / 250MS / 450MS / 750MS / 1000MS).
3. Press and hold the **DIAL** knob to save the new setting and exit to normal operation.

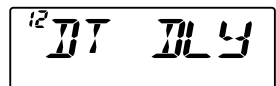
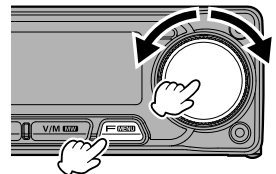



## Memory Operation

The **FT-3185R/E** provides a wide variety of memory system resources. These include:

- 200 “basic” memory channels, numbered “0” through “199”.
- A “Home” channel, providing storage and quick recall of one prime frequency.
- 10 sets of band-edge memories, also known as “Programmable Memory Scan” channels, labeled “L0 / U0” through “L9 / U9”.



Each memory may be appended with an alpha-numeric label of up to six characters, for quick channel recognition.

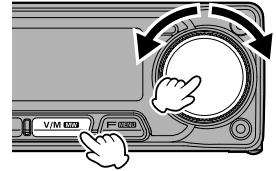

### Memory Storage

1. In the VFO mode, select the desired frequency.
2. Press and hold the  key. A memory number will appear in the top left-hand corner of the display.
3. Rotate the **DIAL** knob to select the desired memory into which you wish to store the frequency.
4. Press and hold the  key, to store the displayed data into the selected memory channel slot.
5. To store other frequencies, repeat steps 1 through 4, remembering to set the repeater shift, CTCSS/DCS tone, and TX power level, as appropriate.





### Storing Independent Transmit Frequencies (“Odd Splits”)

1. Store the receiving frequency using the method already described.
2. Tune to the desired transmit frequency, then press and hold the  key.
3. Rotate the **DIAL** knob to select the same memory channel number used in step 1 above.
4. While pressing and holding the **PTT** switch, and press and hold the  key. This will not cause transmission. Confirmation screen “**OVR.OK?**” is appears.
5. Press and hold the  key. The split memory is stored.

Whenever you recall a memory which contains independently stored transmit and receive frequencies, the “ ” indication will appear in the display.



### Memory Recall

1. Press the  key, repeatedly if necessary, until the “” icon and a memory channel number appear on the display; this indicates that the “Memory Recall” mode is now engaged.
2. When more than one memory has been stored, use the **DIAL** knob to select any of the programmed memories for operation. Press and then turn the **DIAL** knob to select in 10 channel steps. Alternatively, the microphone’s **[UP]** or **[DWN]** key may be used to step or scan through the available memories. When using the microphone’s keys, press the key momentarily to move one step up or down; press and hold the **[UP]** or **[DWN]** key for one second to begin memory scanning.

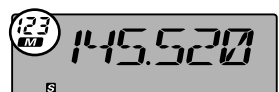
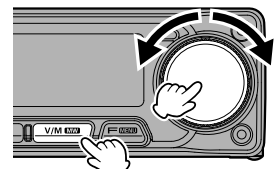



## • Memory Recall from the Microphone's Keypad:

While operating in the Memory Recall mode, the keypad of the **SSM-85D** Microphone may be used for direct recall of memory channels.

To do this, enter the desired channel number on the keypad and then press the [#] key.

**Examples:** To recall Memory channel "123", press [1] → [2] → [3]

To recall Memory channel "16", press [1] → [6] → [#]

You may also recall Programmable Memory Scan (PMS) channels ("L0/U0" through "L9/U9") using the following numbers:

Programmable Memory channels #L0 = "200", U0 = "201", L9 = "218", and U9 = "219".

|    |     |    |     |    |     |    |     |    |     |    |     |    |     |    |     |    |     |    |     |
|----|-----|----|-----|----|-----|----|-----|----|-----|----|-----|----|-----|----|-----|----|-----|----|-----|
| L0 | 200 | L1 | 202 | L2 | 204 | L3 | 206 | L4 | 208 | L5 | 210 | L6 | 212 | L7 | 214 | L8 | 216 | L9 | 218 |
| U0 | 201 | U1 | 203 | U2 | 205 | U3 | 207 | U4 | 209 | U5 | 211 | U6 | 213 | U7 | 215 | U8 | 217 | U9 | 219 |

## Erasing memory channel data

The contents written to the memory channel may be erased.

1. Select the memory channel to be erased.
2. Press and hold the  key, then rotate the **DIAL** knob to select "**DELETE**".
3. Press the **DIAL** knob.  
The erase confirmation screen appears.
4. Press the **DIAL** knob to erase the selected memory channel.

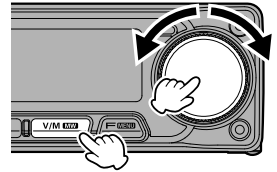

**i** Data on memory channel 00, and Home channel may not be cleared.

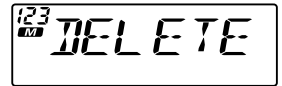

## Copying memories

1. Select the memory channel from which the data is to be copied, then press and hold the  key.
2. Rotate the **DIAL** knob to select "COPY", then press the **DIAL** knob.
3. Rotate the **DIAL** knob to select the copy destination channel.
4. Press and hold the **DIAL** knob to copy the memory channel.

## Copy memory channel information to VFO

Data stored on memory channels can easily be moved to the VFO.

1. Press and hold the **DIAL** knob while recalling memory.  
Copy the contents of the recalled memory channel to the VFO and enter VFO mode.

## Memory-Only Mode

Once memory channel programming has been completed, you may place the transceiver in a "Memory Only" mode, whereby VFO and Home Channel operation are impossible.

To place the transceiver into the Memory Only mode, turn the transceiver OFF. Now press and hold the  key while turning the transceiver ON. The VFO and Home Channel will now be disabled.

To return to normal operation, repeat the above power-on procedure.



## Memory Operation

### Labeling Memories

You may wish to append an alpha-numeric “Tag” (label) to a memory or memories, to aid in recollection of the channel’s use (such as club name, etc.). This is easily accomplished using the Setup Menu mode.

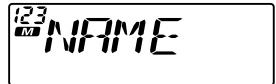
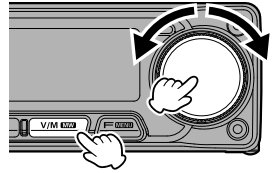
1. Recall the memory channel on which you wish to append a label.
2. Press and hold the  key, then rotate the **DIAL** knob to select “NAME”.



3. Press the **DIAL** knob. You will notice the first character location blinking, indicating that you are now in the Alpha-Numeric (“A/N”) entry mode. Within the A/N entry mode, rotate the **DIAL** knob to select characters; pressing the  key will move the character’s entry location to the right.
4. Rotate the **DIAL** knob to select the desired number, letter, or symbol, then press the  key to move the next character’s location. Press the  key if you want to “backspace” one slot.
5. Repeat step 4, as necessary, to complete the name tag (up to six characters) for the memory, then press and hold the **DIAL** knob to save the A/N name just entered.

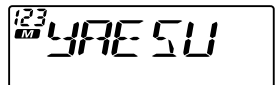

While operating in the Memory Recall mode, press and hold the  key, and then press and hold the **DIAL** knob to change the frequency display indication and the channel’s Alpha/Numeric label.

## Home Channel Memory

### • Recall the Home Channel

With the factory default setting, "HOME" (calls the home channel) is registered to the Function list.

1. Press the  key.
2. Rotate the **DIAL** knob to select "**Fn HOME**", then press the **DIAL** knob.



Or press and hold the  key → Rotate the **DIAL** knob to select "**14 HOME**", then press the **DIAL** knob.



3. "**HOME**" and the home channel frequency appears on the display.
4. Press the  key to return to the previous screen.

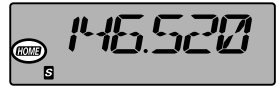



### • Recall with the programmable key on the microphone

With the factory default setting, "HOME" (calls the home channel) is registered to the [P2] key of the Microphone.

1. Press the **[P2]**\* key on the microphone.  
\* This is the factory setting. This function can also be assigned to the [P1] - [P4] key (see page 14).
2. "**HOME**" and the home channel frequency appears on the display.
3. Press the **[P2]** key again, to return to the previous screen.

### • Changing the Home Channel Frequency

The factory default frequency for the Home channel is 146.520MHz (USA version) or 144.000MHz (Asian and European version). The Home channel can be re-programmed in a manner identical to that used for the regular memories:

1. Set the frequency to store as the home channel.
2. Press and hold the  key.
3. Rotate the **DIAL** knob to the left to select "**HOME**".  
"**HOME**" is listed before memory channel "00".
4. Press and hold the  key.  
The confirmation screen appears.
5. Press and hold the  key.  
To overwrite the frequency and return to HOME channel operation.

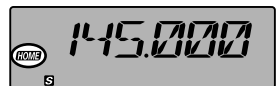
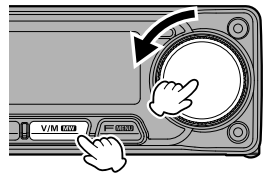

## Scanning

The **FT-3185R/E**'s scanning capability provides the operator with many convenient methods of rapid frequency navigation.

### VFO Scan / Memory Scan

To find frequencies where there are signals in VFO mode or Memory mode:

1. Press and hold the microphone [UP] or [DWN] key to start scanning.  
Or press and hold the  key → select “**26 SCN.ON**” → press the **DIAL** knob.
- If the **DIAL** knob is rotated while scanning is in progress, the scanning will continue up or down in frequency according to the direction of the **DIAL** Knob rotation.
  - Scanning pauses when a signal opens the squelch, and the decimal point on the display will blink. You can choose one of three scan-resume modes (described later).
  - To halt the scan manually, the easiest way is to push the **PTT** switch on the microphone momentarily (no transmission will occur while you are scanning). The scan may also be halted manually by pressing the microphone's [UP] or [DWN] key.

### Scan-Resume Options

Three scan-resume modes are available on the **FT-3185R/E**:

- In the “**BUSY**” mode, the scanner will remain halted for as long as there is carrier present on the channel; after the carrier drops at the end of the other station's transmission, scanning will resume.
- In the “**HOLD**” mode, the scanner will halt on a signal it encounters. It will not restart automatically; you must manually re-initiate scanning if you wish to resume.
- In the “**3SEC / 5SEC / 10SEC**” mode, the scanner will halt for the selected resume time, after which scanning will resume (whether or not the other station is still transmitting).

The default scan-stop mode is “**BUSY**”. To change the scan-resume mode, use the following procedure:

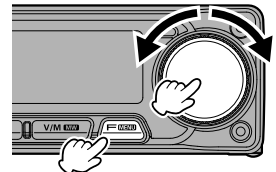

1. Press and hold the  key, then rotate the **DIAL** knob to select “**27 SCN.RSM**”.
2. Press the **DIAL** knob, then rotate the **DIAL** knob to select the desired scan-resume mode.
3. Press and hold the **DIAL** knob to save the new setting and exit to normal operation.



## Memory Skip Scanning

When you have some continuously-active channels in memories, you may wish to skip them for scanning, but still have them available for manual selection.

To mask a memory to be skipped (only) during scanning, use the following procedure:

1. Set the transceiver to the Memory Recall mode by pressing the  key repeatedly, as necessary, until “**M**” and a channel number appear on the left side of the display.
2. Rotate the **DIAL** knob to select the Memory Channel to be skipped during scanning.
3. Press and hold the  key, then rotate the **DIAL** knob to select “**SCAN**”.

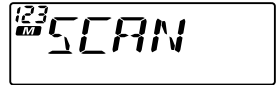
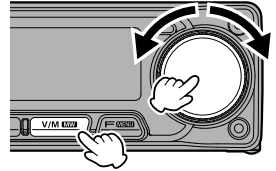

4. Press the **DIAL** knob, then rotate the **DIAL** knob so as to select “**N**”. The current Memory Channel will now be ignored during scanning.

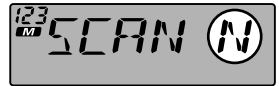

5. Press and hold the **DIAL** knob to save the new setting and exit to normal operation.

A “**SKIP**” icon will appear when you recall the “skipped” memory channel manually.

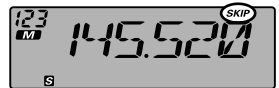

To re-institute a channel into the scanning loop, select “**Y**” in step 4 above, after first recalling the currently-blocked channel (the “Skipped” channel is accessible via manual channel selection methods using the **DIAL** knob in the Memory mode, whether or not it is locked out of the scanning loop).

## Programmable Memory Channel Scan (PMS)

The **FT-3185R/E** can be set to tune or scan only the frequencies between user defined lower and upper band limits.

### • Registering to the Programmable Memory Channels

1. Store the lower edge of the desired scanning/tuning range in memory “**L0**”, and the upper edge in memory “**U0**” (or, alternatively, in memories “**L1/U1**” through “**L9/U9**”).
2. With any of these memories recalled. The “**PMS**” icon will appear.
3. Press and hold the microphone’s [**UP**] or [**DWN**] key to activate the Programmable Band-Scan Limits. Tuning and scanning will now be limited within the just-programmed range.

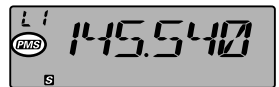

To cancel the Band-Scan Limits and return to normal memory operation, press the  key momentarily.

## Priority Channel Scanning (Dual Watch)

The FT-3185R/E's scanning features include a two-channel scanning capability which allows you to operate on a VFO, Memory channel, or Home channel, while periodically checking a user-defined Memory Channel for activity. If a station is received on the Memory Channel which is strong enough to open the Squelch, the scanner will pause on that station in accordance with the Scan-Resume mode set via Menu item "27 SCN.RSM" (see page 34).

### • Activating the Dual Watch (DW) feature

1. Set the frequency to monitor continually.  
The monitor frequency may be set on the VFO mode or the memory channel mode.
2. Assigning the "DW" function to a programmable key ([P1]/[P2]/[P3]/[P4]) on the microphone.

#### How to assign DW function

1. Press and hold the  key.
  2. Rotate the **DIAL** knob to select the "16 PRG P1", "17 PRG P2", "18 PRG P3" or "19 PRG P4" key to assign a function, then press the **DIAL** knob.
  3. Rotate the **DIAL** knob to select "DW".
  4. Press and hold the **DIAL** knob to save the new setting and exit to normal operation.
3. Press the key to which "DW" function is assigned.
    - The dual watch function is activated.
    - When a signal is received on the priority channel, it will continue to be received until there is no signal.
    - The decimal point will blink while receiving a signal.
  4. Press the key assigned "DW" function to cancel the dual watch function.

### • Priority Revert Mode

During Priority channel operation (Dual Watch), a special feature is available which will allow you to move to the Priority Channel instantly, without waiting for activity to appear on the Priority Channel.

When this feature is enabled, and priority monitoring is engaged, just press the microphone's PTT switch. Operation will instantly revert to the Priority Channel.

To enable Priority Revert operation:

1. Press and hold the  key, then rotate the **DIAL** knob to select "28 DW RVT".
2. Press the **DIAL** knob, then rotate the **DIAL** knob to set this Menu item to "ON".
3. Press and hold the **DIAL** knob to save the new setting and exit to normal operation.

To disable Priority Revert operation, select "OFF" in step 2 above.

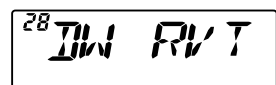
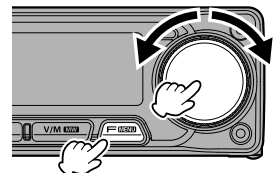

## Weather Alert Scan (USA version only)

This feature allows you to check the Weather Broadcast Memory Channels for the presence of the NOAA Alert Tone while operating using VFO scan or Memory channel scan.

When the Weather Alert Scan feature is engaged, the **FT-3185R** will check the Weather Broadcast Memory Channels for activity every five seconds while scanning. If you watch the display carefully, you'll observe the scanner periodically shifting to the Weather Broadcast bank, scanning the Weather channels quickly in search of the Alert Tone, after which regular scanning will resume for another five seconds.

To enable the Weather Alert Scan feature:

1. Press and hold the  key, then rotate the **DIAL** knob to select "**43 WX ALT**".
2. Press the **DIAL** knob, then rotate the **DIAL** knob to set this Menu item to "ON".
3. Press and hold the **DIAL** knob to save the new setting and exit to normal operation.
4. To disable the Weather Alert Scan feature, select "OFF" in step 2 above.

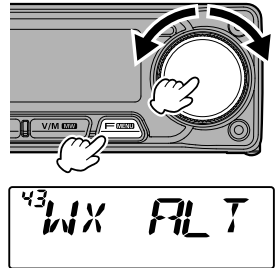

You can change the Weather Alert Tone volume level to maximum regardless the **VOL** knob setting, using Menu item "**44 WX VOL**".

## ARTS™ (Automatic Range Transponder System)

The ARTS™ feature uses DCS signaling to inform both parties when you and another ARTS™-equipped station are within communications range. This may be particularly useful during Search-and Rescue situations, where it is important to stay in contact with other members of your group.

Both stations must set up their DCS codes to the same code number, then activate their ARTS™ feature using the command appropriate for their transceiver. Alert ringers may be activated, if desired.

Whenever you press the **PTT** switch, or every 30 seconds after ARTS™ is activated, your transceiver will transmit a signal which includes a (subaudible) DCS signal for about 1 second. If the other transceiver is in range, the beeper will sound (if enabled) and the display will show "IN.RNG" as opposed to the out of range display "OUT.RNG" in which ARTS™ operation begins.



Whether you talk or not, the polling every 30 seconds will continue until you de-activate ARTS™. When ARTS™ is de-activated, DCS will also be deactivated (if you were not using it previously in non-ARTS™ operation).

If you move out of range for more than 80 seconds, your transceiver will sense that no signal has been received, two beeps will sound, and the display will revert to "OUT.RNG". If you move back into range, your transceiver will again beep, and the display will change back to the "IN.RNG" indication.

During ARTS™ operation, your operating frequency will continue to be displayed, but no changes may be made to it or other settings; you must terminate ARTS™ in order to resume normal operation. This is a safety feature designed to prevent accidental loss of contact due to channel change, etc.

### Basic ARTS™ Setup and Operation

1. Assign the ARTS™ feature to the microphone's programmable key ([P1], [P2], [P3], or [P4]).
2. Set your transceiver and the other transceiver(s) to the same DCS code number.
3. Press the assigned microphone's programmable key momentarily. You will observe the "OUT.RNG" display on the LCD. ARTS™ operation has now commenced.
4. Every 30 seconds, your transceiver will transmit a "polling" call to the other station. When that station responds with its own ARTS™ polling signal, the display will change to "IN.RNG" to confirm that the other station's polling code was received in response to yours.
5. Press the assigned microphone's programmable key momentarily to exit ARTS™ operation and resume normal functioning of the transceiver.





## Time-Out Timer (TOT)

The “Time-Out Timer” (TOT) feature is designed to force the transceiver into the “receive” mode after a preset time period of continuous transmission (the default is 3 minutes). This feature prevents your transceiver from transmitting a “dead carrier” for a long period of time in the event that the microphone **PTT** switch is accidentally locked in the “TX” condition.

The Time-Out Timer’s “switch-to-receive” time may be adjusted to 1, 2, 3, 5, 10, 15, 20, 30 minutes, or OFF.

To change the default (3 minutes) time setting:

1. Press and hold the **F-MEMO** key, then rotate the **DIAL** knob to select “38 TOT”.
2. Press the **DIAL** knob, then rotate the **DIAL** knob to select the desired interval (1 / 2 / 3 / 5 / 10 / 15 / 20 / 30 minutes), or OFF.
3. Press and hold the **DIAL** knob to save the new setting and exit to normal operation.

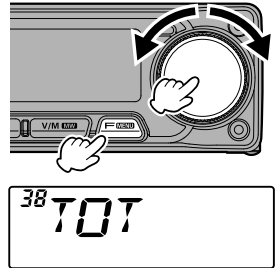

**i** When your transmission time is within 10 seconds of the Time-Out Timer expiration, an Alert bell will provide an audible warning from the speaker.

## Automatic Power-Off (APO)

The “Automatic Power-Off” (APO) feature will turn the transceiver completely *OFF* after a user-defined period of **PTT** or key inactivity. If you do not press any front panel keys, rotate the **DIAL** knob, use the microphone’s keys, or transmit, and so long as the transceiver is not scanning or engaged in priority monitoring, the transceiver will shut itself off after the specified time period. The available selections for the time before power-off are 0.5 / 1 / 3 / 5 / 8 hours, as well as APO OFF. This feature is useful in minimizing battery drain in a mobile installation if you forget to turn the transceiver off when you leave your vehicle.

To activate the APO feature:

1. Press and hold the **F-MEMO** key, then rotate the **DIAL** knob to select “01 APO”.
2. Press the **DIAL** knob, then rotate the **DIAL** knob to select the desired “switch-off” time or OFF.
3. Press and hold the **DIAL** knob to save the new setting and exit to normal operation.

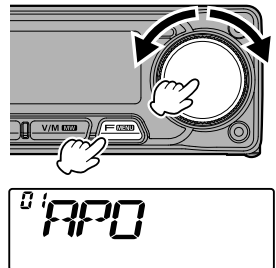

If there is no action by you within the time interval programmed, an Alert bell will provide an audible warning from the speaker within 1 minute of the APO Timer expiration, then the microprocessor will shut down the transceiver automatically.

## Miscellaneous Settings

### Programming the Key Assignments

Default FT-3185R/E key functions have been assigned to the Microphone's [P1]/[P2]/[P3]/[P4] keys at the factory. These may be changed by the user, if you wish to assign quick access to another function.

To change the assignments for the programmable keys:

1. Press and hold the  key, then rotate the **DIAL** knob to select the Menu Item to be configured ("16 PRG P1", "17 PRG P2", "18 PRG P3" or "19 PRG P4").
2. Press the **DIAL** knob, then rotate the **DIAL** knob to select the function you wish to assign to the key you selected in the previous step. The available choices are vary slightly among the four keys you may program, and they include:

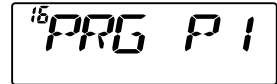
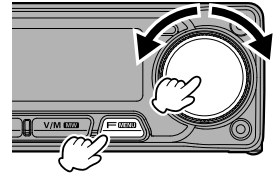

| Key | Function                        | Description                                    |
|-----|---------------------------------|--|
| P1  | SQL.OFF                         | Opens the squelch (SQL off)                    |
| P2  | HOME                            | Recalls the HOME channel                       |
| P3  | DW                              | Operation setting of dual receive function     |
| P4  | WX-CH (USA version)             | Switches operation to the Weather Channel Bank |
|     | T-CALL (European/Asian version) | Transmits the T-CALL (1750Hz)                  |

- ARTS** :Engages the ARTS™ operation  
**SCN ON** :Engages the Scan operation  
**HOME** :Recalls the HOME channel  
**RPT.SFT** :Sets the repeater shift direction  
**REV** :Reverses the transmit and receive frequencies in repeater mode  
**TX PWR** :Selects the transmit power output level  
**SQL.OFF** :Opens the Squelch to allow un-muted reception  
**T-CALL** :Activates 1750Hz Tone Burst  
**DW** :Operation setting of dual receive function  
**WX-CH** :Switches operation to the Weather channels bank (USA version only)

3. Press the **DIAL** knob momentarily to save the new setting, then rotate the **DIAL** knob to select another programmable key to modify, if desired, and repeat the above steps.
4. Press and hold the **DIAL** knob to save the new setting and exit to normal operation.

### FM Bandwidth & TX Deviation Level

You can reduce the receiver bandwidth and microphone deviation level when operating on tightly-clustered frequencies (channel spacing of 12.5 or 15kHz). This will reduce the transmitter deviation, thus minimizing interference to other users.

To configure for the narrower bandwidth, use the following procedure:

1. Press and hold the  key, then rotate the **DIAL** knob to select “**42 WIDTH**”.
2. Press the **DIAL** knob, then rotate the **DIAL** knob to change the display to “NARROW”.
3. Press and hold the **DIAL** knob to save the new setting and exit to normal operation.

To return to wide bandwidth and deviation, repeat the above procedure, selecting “WIDE” in step 2 above.

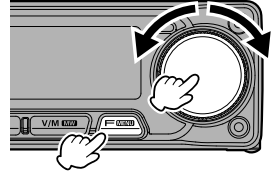

### MIC Gain Setting

At the factory, a microphone gain has been programmed that should be satisfactory for the supplied **SSM-85D** Microphone. If you use an after-market microphone, you may wish to set a different Mic Gain level, using Set Mode item “**15 MCGAIN**”.

1. Press and hold the  key, then rotate the **DIAL** knob to select “**15 MCGAIN**”.
2. Press the **DIAL** knob, then rotate the **DIAL** knob to set the desired level (Default: NORMAL).
3. Press and hold the **DIAL** knob to save the new setting and exit to normal operation.

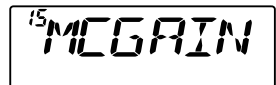
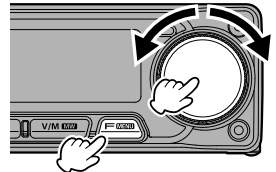

### Busy Channel Lock-Out (BCLO)

The BCLO feature prevents the radio's transmitter from being activated if a signal strong enough to break through the “noise” squelch is present. On a frequency where stations using different CTCSS or DCS codes may be active, BCLO prevents you from disrupting their communications accidentally (because your radio may be muted by its own Tone Decoder). The default setting for the BCLO is OFF, and here is how to change that setting:

1. Press and hold the  key, then rotate the **DIAL** knob to select “**04 BCLO**”.
2. Press the **DIAL** knob, then rotate the **DIAL** knob to set this Menu item to “ON”.
3. Press and hold the **DIAL** knob to save the new setting and exit to normal operation.
4. To disable the BCLO feature, select “OFF” in step 2 above.

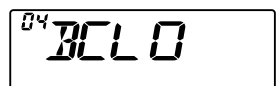
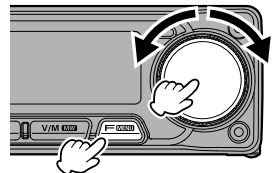

## Miscellaneous Settings

### Displaying the Temperature

Indicates the current temperature inside the transceiver.

Note: See Setup Menu Item “**37 TEMP**” on page 45.

### Displaying the Supply Voltage

Display the Power Supply voltage.

Note: See Setup Menu Item “**41 DC VLT**” on page 45.

### DCS Code Inversion

DCS uses a codeword consisting of a 23-bit frame, transmitted (subaudible) at a data rate of 134.4 bps (bit/sec).

Occasionally, signal inversion can result in the complement of a code to be sent or received. This prevents the receiver’s squelch from opening with DCS enabled, as the decoded bit sequence would not match that selected for operation.

Typical situations that might cause inversion to occur are:

- Connection of an external receiver preamplifier.
- Operating through a repeater.
- Connection of an external linear amplifier.

Note that code inversion does not mean that any of the above listed equipment is defective!

In certain amplifier configurations, the output signal (phase) is inverted from the input.

Small signal or power amplifiers having an odd number (1, 3, 5, etc.) of amplification stages may result in inversion of a transmitted or received DCS code.

While under most circumstances this should not occur, if you find that your receiver squelch does not open when both you and the other station are using a common DCS code, you or the other station (but not both) can try the following:

1. Press and hold the  key, then rotate the **DIAL** knob to select “**32 DCS RV**”.
2. Press the **DIAL** knob, then rotate the **DIAL** knob to set this Menu item to “ENABLE”.
3. Press and hold the **DIAL** knob to save the new setting and exit to normal operation.
4. To disable the BCLO feature, select “DISBLE(DISABLE)” in step 2 above.

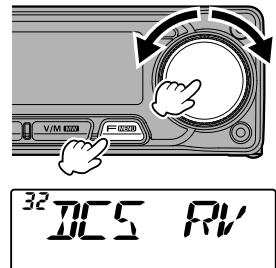

## Reset Procedure

In some instances of erratic or unpredictable operation, the cause may be corruption of data in the microprocessor (due to static electricity, etc.). If this happens, resetting of the microprocessor may restore normal operation. Note that all memories will be erased if you do a complete microprocessor reset, as described below.

### All Reset

To clear all memories and other settings to factory defaults:

1. Turn the transceiver OFF.
2. Press and hold the **F-STORE** key and **DIAL** knob while turning the transceiver ON.

The “**ALL.RST**” notation will on the display.

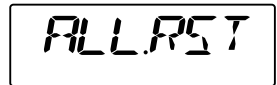
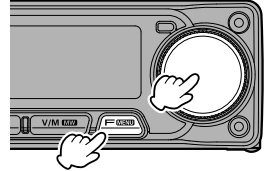

3. Press the **DIAL** knob.  
The “**RST.OK?**” notation will on the display.  
Turn the transceiver OFF to cancel the Reset procedure.



4. Press the **DIAL** knob to reset all settings to their factory defaults.

### Set Mode Resetting

To reset the Setup Menu mode settings to their factory defaults, while leaving other settings unchanged:

1. Turn the transceiver OFF.
2. Press and hold the **S-DX** and **DIAL** keys while turning the transceiver ON.

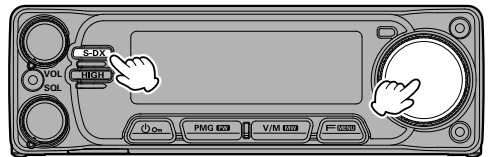

The “**SMD.RST**” notation will on the display.

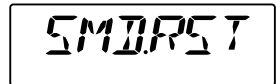

3. Press the **DIAL** knob.  
The “**RST.OK?**” notation will on the display.  
Turn the transceiver OFF to cancel the Reset procedure.



4. Press the **DIAL** knob to reset the Setup Menu mode settings to their factory defaults.

## Setup (Menu) Mode

The **FT-3185R/E** Setup Menu mode, already described in parts of many previous chapters, is easy to activate and set. It may be used for configuration of a wide variety of transceiver parameters, some of which have not been detailed previously. Use the following procedure to activate the Setup Menu mode:

1. Press and hold the  key to enter the Setup mode.
2. Rotate the **DIAL** knob to select the Menu Item to be adjusted.
3. Press the **DIAL** knob to enable adjustment of the selected Menu item, then rotate the **DIAL** knob to perform the actual adjustment.
4. After completing your selection and adjustment, press and hold the **DIAL** knob to exit the Setup mode and resume normal operation.

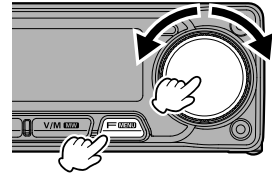

| Menu Item  | Function   | Available Values   | Default |
|------------|--|--|---------|
| 1 APO      | Enables/Disables the Automatic Power Off feature.                                      | OFF / 0.5H / 1.0H / 3.0H / 5.0H / 8.0H   | OFF     |
| 2 AR MOD   | Selects the Beep option during ARTS™ operation.  | OFF / IN RNG / OUTRNG  | IN RNG  |
| 3 AR INT   | Selects the Polling Interval during ARTS™ operation.                                   | 30 SEC / 1 MIN   | 30 SEC  |
| 4 BCLO     | Enables/Disables the Busy Channel Lock-Out feature.                                    | OFF / ON   | OFF     |
| 5 BEEP     | Enables/Disables the key beeper.   | OFF / LOW / HIGH   | LOW     |
| 6 BELL     | Selects the CTCSS/DCS/EPCS Bell Ringer repetitions.                                    | OFF / 1TIME / 3TIMES / 5TIMES / 8TIMES / CONTI   | OFF     |
| 7 CLK.TYP  | Shifting of the CPU clock frequency.   | TYP A / TYP B  | TYP A   |
| 8 DIMMER   | Setting of the front panel display's illumination level.                               | OFF / MID / MAX  | OFF     |
| 9 DTMF     | Enables/Disables the DTMF Autodialer feature.  | MANUAL / AUTO  | MANUAL  |
| 10 DT TX   | Load DTMF Autodialer Memories.   | ---  | ---     |
| 11 DT MEM  | Set the DTMF auto dialer channel and code (16 characters).                             | d1 - d9  | ---     |
| 12 DT DLY  | Setting of the DTMF Autodialer's TX Delay Time.  | 50MS / 250MS / 450MS / 750MS / 1SEC  | 450MS   |
| 13 DT SPD  | Setting of the DTMF Autodialer Sending Speed.  | 50 MS / 100 MS   | 50 MS   |
| 14 HOME    | Recall the home channel.   | ---  | ---     |
| 15 MCGAIN  | Adjust the microphone gain level.  | MIN / LOW / NORMAL / HIGH / MAX  | NORMAL  |
| 16 PRG P1  | Programming the function assigned to Microphone's [P1] key.                            | ARTS / SCN ON / HOME / RPT.SFT / REV / TX PWR / SQL.OFF / T-CALL / DW / WX-CH (USA version only) | SQL.OFF |
| 17 PRG P2  | Programming the function assigned to Microphone's [P2] key.                            |  | HOME    |
| 18 PRG P3  | Programming the function assigned to Microphone's [P3] key.                            |  | DW      |
| 19 PRG P4  | Programming the function assigned to Microphone's [P4] key.                            |  | WX-CH   |
| 20 PAG.CDR | Setting the Receiver Pager Code for the Enhanced CTCSS Paging & Code Squelch function. |  | ---     |

## Setup (Menu) Mode

| Menu Item               | Function   | Available Values  | Default    |
|-------------------------|--|---|------------|
| 21 PAG.CDT              | Setting the Transmitting Pager Code for the Enhanced CTCSS Paging & Code Squelch function. | ---   | 05.47      |
| 22 RPT.REV              | Reverses the transmit and receive frequencies while working through a repeater.            | ---   | ---        |
| 23 RPT.SFT              | Sets the Repeater Shift direction.   | SIMP / -RPT / +RPT  | SIMP       |
| 24 RPT.ARS              | Activates/Deactivates the Automatic Repeater Shift feature.                                | OFF / ON  | ON         |
| 25 RPT.FRQ              | Sets the magnitude of the Repeater Shift.  | 0.0 - 99.95M (MHz)  | 0.60M      |
| 26 SCN.ON               | Engages the Scan operation.  | ---   | ---        |
| 27 SCN.RSM              | Selects the Scan Resume mode.  | 3SEC / 5SEC / 10SEC / BUSY / HOLD   | BUSY       |
| 28 DW.RVT               | The transmission operation during dual watch always transmits on the priority channel.     | OFF / ON  | OFF        |
| 29 SQL.TYP              | Selects the Tone Encoder and/or Decoder mode.  | OFF / TONE / TON.SQL / DCS / RV TON / PAGER / (D CODE)* <sup>1</sup> / (T DCS)* <sup>1</sup> / (D TONE)* <sup>1</sup> | OFF        |
| 30 TON.FRQ              | Setting of the TX/RX CTCSS Tone Frequency.   | 50 standard CTCSS tones   | 100.0 (Hz) |
| 31 DCS.COD              | Setting of the TX/RX DCS code.   | 104 standard DCS codes  | 023        |
| 32 DCS.RV               | Enables/Disables "Inverted" DCS code decoding.   | DISBLE(DISABLE) / ENABLE  | DISBLE     |
| 33 SQL.EXP              | Separate squelch type setting for transmit and receive.                                    | OFF / ON  | OFF        |
| 34 TS.MUT               | Enables/Disables the receiver audio output during the Tone Search Scanner is activated.    | OFF / ON  | ON         |
| 35 TS.SPD               | Selects the Tone Search Scanner speed.   | FAST / SLOW   | FAST       |
| 36 STEP                 | Sets the Synthesizer steps.  | AUTO / 5.0k / 6.25k / 10.0k / 12.5k / 15.0k / 20.0k / 25.0k / 50.0k / 100.0k  | AUTO       |
| 37 TEMP                 | Indicates the current temperature inside the transceiver's case.                           | ---   | ---        |
| 38 TOT                  | Sets the Time-Out Timer.   | OFF / 1MIN / 2MIN / 3MIN / 5MIN / 10MIN / 15MIN / 20MIN / 30MIN   | 3MIN       |
| 39 TX.PWR               | Sets the transmit power level.   | 5W / 20W / 50W / 85W  | 85W        |
| 40 VER.DSP              | Display the software version.  | ---   | ---        |
| 41 DC.VLT               | Indicates the DC Supply Voltage.   | ---   | ---        |
| 42 WIDTH                | Reduction of the Microphone Gain/Deviation and receiver bandwidth.                         | WIDE / NARROW   | WIDE       |
| 43 WX.ALT* <sup>2</sup> | Enables/Disables the Weather Alert feature.  | OFF / ON  | OFF        |
| 44 WX.VOL* <sup>2</sup> | Selects the audio output level of the Weather Alert.                                       | NOR.VOL / MAX.VOL   | NOR.VOL    |

\*1 The options in the parentheses are available when the Set Mode Item "33 SQL.EXP" is ON.

\*2 USA version only.

## Setup (Menu) Mode

### Menu Selection Details

---

#### 01 APO

**Function:** Enables/Disables the Automatic Power OFF feature.

**Available Values:** OFF / 0.5H / 1.0H / 3.0H / 5.0H / 8.0H

**Default:** OFF

#### 02 AR MOD

**Function:** Selects the Beep option during ARTS operation.

**Available Values:** OFF / IN RNG / OUTRNG

**Default:** IN RNG

**IN RNG:** While within range “**IN.RNG**” will appear on the LCD every time a polling transmission is received from the other station, also the alert beeps will be heard. While out of range “**OUT.RNG**” will appear on the LCD. The beeps are issued only when the radio first confirms that the stations are out of range, but does not re-confirm with beeps thereafter.

**OUTRNG:** While within range “**IN.RNG**” will appear on the LCD. The beeps are issued only when the radio first confirms that the stations are within range, but does not re-confirm with beeps thereafter. While out of range “**OUT.RNG**” will appear on the LCD. A beep sounds every time the signal of the partner station cannot be received for 80 seconds.

**OFF:** No alert beeps sound.

#### 03 AR INT

**Function:** Selects the Polling Interval during ARTS operation.

**Available Values:** 30SEC / 1MIN

**Default:** 30SEC

#### 04 BCLO

**Function:** Enables/Disables the Busy Channel Lock-Out feature.

**Available Values:** OFF / ON

**Default:** OFF

#### 05 BEEP

**Function:** Selects the key beeper level.

**Available Values:** OFF / LOW / HIGH

**Default:** LOW

#### 06 BELL

**Function:** Selects the CTCSS/DCS/EPCS Bell Ringer repetitions.

**Available Values:** OFF / 1TIME / 3TIMES / 5TIMES / 8TIMES /  
CONTI (Continuous ringing)

**Default:** OFF



### 07 CLK.TYP

---

**Function:** Shifting of the CPU clock frequency.

**Available Values:** TYP A / TYP B

**Default:** TYP A

**Note:** This function is only used to move a spurious response “birdie”, should it fall on a desired frequency.

### 08 DIMMER

---

**Function:** Setting of the front panel display’s illumination level.

**Available Values:** OFF / MID / MAX

**Default:** OFF

### 09 DTMF

---

**Function:** Enables/Disables the DTMF Autodialer feature.

**Available Values:** MANUAL / AUTO

**Default:** MANUAL

See page 28 for details.

### 10 DT TX

---

**Function:** Transmitting the registered DTMF code.

1. Press and hold the  key.
2. Rotate the **DIAL** knob to select “**10 DT TX**” then press the **DIAL** knob.
3. Rotate the **DIAL** knob to select the desired channel (d1 to d9).
4. Press the PTT switch.

The DTMF code registered in the DTMF memory channel is automatically transmitted.

### 11 DT MEM

---

Register the DTMF memory (maximum 16 digits, 9 channels) for automatic transmission with the auto dialer.

See page 28 for details.

### 12 DT DLY

---

**Function:** Setting of the DTMF Autodialer’s TX Delay Time.

**Available Values:** 50MS / 250MS / 450MS / 750MS / 1SEC

**Default:** 450MS

### 13 DT SPD

---

**Function:** Setting of the DTMF Autodialer Sending Speed.

**Available Values:** 50MS (high speed) / 100MS (low speed)

**Default:** 50MS

### 14 HOME

---

**Function:** Recalls the home channel.

Press and hold the  key → “**14 HOME**” → Press the **DIAL** knob.

**Note:** This item is registered in the Function List by factory setting.

## Setup (Menu) Mode

### 15 MCGAIN

---

**Function:** Adjust the microphone gain level.

**Available Values:** MIN / LOW / NORMAL / HIGH / MAX

**Default:** NORMAL

### 16 PRG P1

---

**Function:** Programming the function assigned to Microphone's [P1] key.

**Available Values:** ARTS / SCN ON / HOME / RPT.SFT / REV / TX PWR / SQL.OFF / T-CALL / DW / WX-CH (USA version only).

**Default:** SQL.OFF

### 17 PRG P2

---

**Function:** Programming the function assigned to Microphone's [P2] key.

**Available Values:** ARTS / SCN ON / HOME / RPT.SFT / REV / TX PWR / SQL.OFF / T-CALL / DW / WX-CH (USA version only).

**Default:** HOME

### 18 PRG P3

---

**Function:** Programming the function assigned to Microphone's [P3] key.

**Available Values:** ARTS / SCN ON / HOME / RPT.SFT / REV / TX PWR / SQL.OFF / T-CALL / DW / WX-CH (USA version only).

**Default:** DW

### 19 PRG P4

---

**Function:** Programming the function assigned to Microphone's [P4] key.

**Available Values:** ARTS / SCN ON / HOME / RPT.SFT / REV / TX PWR / SQL.OFF / T-CALL / DW / WX-CH (USA version only).

**Default:** USA Version: WX-CH, Asian and European Version: T-CALL

### 20 PAG.CDR

---

Setting the Receiver Pager Code for the Enhanced CTCSS Paging & Code Squelch function.

See page 26 for details.

### 21 PAG.CDT

---

Setting the Transmitting Pager Code for the Enhanced CTCSS Paging & Code Squelch function.

See page 26 for details.

### 22 RPT.REV

---

The "reverse" operation temporarily reverses the transmit and receive frequencies. This permits checking to find if direct communication with the other station is possible.

1. Press and hold the  key → "22 RPT.REV" → Press the **DIAL** knob
  - The transmit and receive frequencies are temporarily reversed ("reverse" state).
  - In the "reverse" state, the "-" or "+" blinks on the display.
2. To release the reverse state, repeat the above steps again.

**Note:** This item is registered in the Function List by factory setting.

### 23 RPT.SFT

---

**Function:** Sets the Repeater Shift direction.

**Available Values:** SIMP / -RPT / +RPT

**Default:** SIMP

**Note:** This item is registered in the Function List by factory setting.

### 24 RPT.ARS

---

**Function:** Activates/Deactivates the Automatic Repeater Shift feature.

**Available Values:** OFF / ON

**Default:** ON

### 25 RPT.FRQ

---

**Function:** Sets the magnitude of the Repeater Shift.

**Available Values:** 0.0M - 99.95M (MHz)

**Default:** 0.6M

### 26 SCN.ON

---

Start scanning for channels in VFO mode or Memory mode.

1. Press and hold the  key → “22 RPT.REV” → Press the **DIAL** knob

### 27 SCN.RSM

---

**Function:** Selects the Scan Resume mode.

**Available Values:** 3SEC / 5SEC / 10SEC / BUSY / HOLD

**Default:** BUSY

**3SEC/5SEC/10SEC:** The scanner will hold for the selected resume time, then resume whether or not the other station is still transmitting.

**BUSY:** The scanner will hold until the signal disappears, then will resume when the carrier drops.

**HOLD:** The scanner will stop when a signal is received, and will not re-start.

### 28 DW RVT

---

**Function:** Set to always Transmit on the priority channel when PTT is pressed during dual watch operation.

**Available Values:** OFF / ON

**Default:** OFF

**ON:** Always send on the priority channel.

**OFF:** Sends at the currently displayed frequency.

## Setup (Menu) Mode

### 29 SQL.TYP

**Function:** Selects the Tone Encoder and/or Decoder mode.

**Available Values:** OFF / TONE / TON.SQL / DCS / RV TON / PAGER /  
(D CODE) / (T DCS) / (D TONE)

**Default:** OFF

**TONE:** CTCSS Encoder

**TON.SQL:** CTCSS Encoder/Decoder

**DCS:** Digital Coded Encoder/Decoder

**RV TON:** Reverse CTCSS Decoder (Mutes receiver when matching tone is received)

**PAGER:** Enhanced Paging & Code Squelch

**Note:** The options in the parentheses are available when the Set Mode Item "33 SQL.  
EXP" is ON.

This item is registered in the Function List by factory setting.

### 30 TON.FRQ

**Function:** Setting of the CTCSS Tone Frequency. Separate CTCSS tones can be set for transmit and receive.

**Available Values:** 50 standard CTCSS tones

**Default:** 100.0 R / 100.0 T

**Note:** This item is registered in the Function List by factory setting.

| CTCSS TONE FREQUENCY (Hz) |       |       |       |       |       |       |       |       |       |       |       |
|---------------------------|-------|-------|-------|-------|-------|-------|-------|-------|-------|-------|-------|
| 67.0                      | 69.3  | 71.9  | 74.4  | 77.0  | 79.7  | 82.5  | 85.4  | 88.5  | 91.5  | 94.8  | 97.4  |
| 100.0                     | 103.5 | 107.2 | 110.9 | 114.8 | 118.8 | 123.0 | 127.3 | 131.8 | 136.5 | 141.3 | 146.2 |
| 151.4                     | 156.7 | 159.8 | 162.2 | 165.5 | 167.9 | 171.3 | 173.8 | 177.3 | 179.9 | 183.5 | 186.2 |
| 189.9                     | 192.8 | 196.6 | 199.5 | 203.5 | 206.5 | 210.7 | 218.1 | 225.7 | 229.1 | 233.6 | 241.8 |
| 250.3                     | 254.1 | -     | -     | -     | -     | -     | -     | -     | -     | -     | -     |

### 31 DCS.COD

**Function:** Setting of the DCS code. Separate DCS codes can be set for transmit and receive.

**Available Values:** 104 standard DCS codes

**Default:** 023 R / 023 T

**Note:** This item is registered in the Function List by factory setting.

| DCS CODE |     |     |     |     |     |     |     |     |     |     |     |     |
|----------|-----|-----|-----|-----|-----|-----|-----|-----|-----|-----|-----|-----|
| 023      | 025 | 026 | 031 | 032 | 036 | 043 | 047 | 051 | 053 | 054 | 065 | 071 |
| 072      | 073 | 074 | 114 | 115 | 116 | 122 | 125 | 131 | 132 | 134 | 143 | 145 |
| 152      | 155 | 156 | 162 | 165 | 172 | 174 | 205 | 212 | 223 | 225 | 226 | 243 |
| 244      | 245 | 246 | 251 | 252 | 255 | 261 | 263 | 265 | 266 | 271 | 274 | 306 |
| 311      | 315 | 325 | 331 | 332 | 343 | 346 | 351 | 356 | 364 | 365 | 371 | 411 |
| 412      | 413 | 423 | 431 | 432 | 445 | 446 | 452 | 454 | 455 | 462 | 464 | 465 |
| 466      | 503 | 506 | 516 | 523 | 526 | 532 | 546 | 565 | 606 | 612 | 624 | 627 |
| 631      | 632 | 654 | 662 | 664 | 703 | 712 | 723 | 731 | 732 | 734 | 743 | 754 |

### 32 DCS RV

**Function:** Enables/Disables "Inverted" DCS code decoding.

**Available Values:** DISBLE (DISABLE) / ENABLE

**Default:** DISBLE

### 33 SQL.EXP

---

**Function:** The squelch type can be set separately for transmit and receive.

**Available Values:** OFF / ON

**Default:** OFF

**ON:** Add squelch types for signaling.

**OFF:** Does not add squelch types for signaling.

### 34 TS MUT

---

**Function:** Enables/Disables the receiver audio output while the Tone Search Scanner is activated.

**Available Values:** OFF / ON

**Default:** ON

### 35 TS SPD

---

**Function:** Selects the Tone Search Scanner speed.

**Available Values:** FAST / SLOW

**Default:** FAST

### 36 STEP

---

**Function:** Sets the Synthesizer steps.

**Available Values:** AUTO / 5.0K / 6.25K / 10.0K / 12.5K / 15.0K / 20.0K / 25.0K / 50.0K / 100.0K

**Default:** AUTO

### 37 TEMP

---

**Function:** Indicates the current temperature inside the transceiver's case.

**Note:** Rotate the **DIAL** knob to toggle between Fahrenheit (°F) and Celsius (°C) temperature display.

### 38 TOT

---

**Function:** Sets the Time-Out Timer.

**Available Values:** OFF / 1MIN / 2MIN / 3MIN / 5MIN / 10MIN / 15MIN / 20MIN / 30MIN

**Default:** USA Version: 3MIN, Asian and European Version: OFF

The time-out timer shuts off the transmitter after continuous transmission of the programmed time.

### 39 TX PWR

---

**Function:** Sets the transmit power level.

**Available Values:** 5W / 20W / 50W / 85W

**Default:** 85W

### 40 VER.DSP

---

**Function:** Display the software versions.

### 41 DC VLT

---

**Function:** Indicates the DC Supply Voltage.

## Setup (Menu) Mode

### 42 WIDTH

---

**Function:** Reduction of the Microphone Gain/Deviation and receiver bandwidth.

**Available Values:** WIDE ( $\pm 5$ kHz Deviation, 15kHz Bandwidth) / NARROW ( $\pm 2.5$ kHz Deviation, 6kHz Bandwidth)

**Default:** WIDE ( $\pm 5$ kHz Deviation, 15kHz Bandwidth)

### 43 WX ALT (USA version only)

---

**Function:** Enables/Disables the Weather Alert feature.

**Available Values:** OFF / ON

**Default:** OFF

### 44 WX VOL (USA version only)

---

**Function:** Selects the audio output level of the Weather Alert Tone.

**Available Values:** NOR.VOL / MAX.VOL

**Default:** NOR.VOL

## General

|                                       |  |
|---------------------------------------|--|
| <b>Frequency Range:</b>               | Tx 144 - 148MHz or 144 - 146MHz<br>(Depends on the transceiver version)<br>Rx 136 - 174MHz       |
| <b>Channel Step:</b>                  | 5 / 6.25 / 10 / 12.5 / 15 / 20 / 25 / 50 / 100kHz  |
| <b>Standard Repeater Shift:</b>       | ±600kHz  |
| <b>Frequency Stability:</b>           | Better than ±5ppm (-4°F to +140°F [-20°C to +60°C])  |
| <b>Modes of Emission:</b>             | F2D / F3E  |
| <b>Antenna Impedance:</b>             | 50 Ohms, unbalanced  |
| <b>Supply voltage:</b>                | 13.8V DC ±15%, negative ground   |
| <b>Current Consumption (typical):</b> | Rx: less than 0.7A, less than 0.5A (squelched)<br>Tx: 15A (85W) / 11A (50W) / 7A (20W) / 3A (5W) |
| <b>Operating Temperature Range:</b>   | -4°F to +140°F (-20°C to +60°C)  |
| <b>Case Size (WxHxD):</b>             | 6.3" x 2" x 7.3" (160 x 50 x 185mm) (w/o knobs)  |
| <b>Weight (Approx.):</b>              | 4.2lb (1.9kg)  |

## Transmitter

|                              |                                  |
|------------------------------|----------------------------------|
| <b>Output Power:</b>         | 85W / 50W / 20W / 5W             |
| <b>Modulation Type:</b>      | Variable Reactance               |
| <b>Maximum Deviation:</b>    | ±5kHz (Wide)<br>±2.5kHz (Narrow) |
| <b>Spurious Radiation:</b>   | Better than -60dB                |
| <b>Microphone Impedance:</b> | 2k-Ohms                          |

## Receiver

|                                      |   |
|--------------------------------------|---|
| <b>Circuit Type:</b>                 | Double Conversion Superheterodyne   |
| <b>I<sub>fs</sub>:</b>               | 21.7MHz & 450kHz  |
| <b>Sensitivity (for 12dB SINAD):</b> | Better than 0.16µV (136 - 140MHz)<br>Better than 0.14µV (140 - 150MHz)<br>Better than 0.19µV (150 - 174MHz) |
| <b>Selectivity (-60dB):</b>          | 30kHz   |
| <b>Maximum AF Output:</b>            | 3W into 8ohms @10% THD  |

***Specifications subject to change without notice or obligation. Specifications guaranteed only within Amateur band.***

***Frequency ranges will vary according to transceiver version; check with your dealer.***

# YAESU LIMITED WARRANTY

Limited Warranty is valid only in the country/region where this product was originally purchased.

## On-line Warranty Registration:

Thank you for buying YAESU products! We are confident your new radio will serve your needs for many years! Please register your product at [www.yaesu.com](http://www.yaesu.com) - Owner's Corner

## Warranty Terms:

Subject to the Limitations of the Warranty and the Warranty Procedures described below, YAESU MUSEN hereby warrants this product to be free of defects in materials and workmanship in normal use during the "Warranty Period." (the "Limited Warranty").

### Limitations of Warranty:

- A. YAESU MUSEN is not liable for any express warranties except the Limited Warranty described above.
- B. The Limited Warranty is extended only to the original end-use purchaser or the person receiving this product as a gift, and shall not be extended to any other person or transferee.
- C. Unless a different warranty period is stated with this YAESU product, the Warranty Period is three years from the date of retail purchase by the original end-use purchaser.
- D. The Limited Warranty is valid only in the country/region where this product was originally purchased.
- E. During the Warranty Period, YAESU MUSEN will, at its sole option, repair or replace (using new or refurbished replacement parts) any defective parts within a reasonable period of time and free of charge.
- F. The Limited Warranty does not cover shipping cost (including transportation and insurance) from you to us, or any import fees, duties or taxes.
- G. The Limited Warranty does not cover any impairment caused by tampering, misuse, failure to follow instructions supplied with the product, unauthorized modifications, or damage to this product for any reasons, such as: accident; excess moisture; lightning; power surges; connection to improper voltage supply; damage caused by inadequate packing or shipping procedures; loss of, damage to or corruption of stored data; product modification to enable operation in another country/purpose other than the country/purpose for which it was designed, manufactured, approved and/or authorized; or the repair of products damaged by these modifications.
- H. The Limited Warranty applies only to the product as it existed at the time of the original purchase, by the original retail purchaser, and shall not preclude YAESU MUSEN from later making any changes in design, adding to, or otherwise improving subsequent versions of this product, or impose upon YAESU MUSEN any obligation to modify or alter this product to conform to such changes, or improvements.
- I. YAESU MUSEN assumes no responsibility for any consequential damages caused by, or arising out of, any such defect in materials or workmanship.
- J. TO THE FULLEST EXTENT PERMITTED BY LAW, YAESU MUSEN SHALL NOT BE RESPONSIBLE FOR ANY IMPLIED WARRANTY WITH RESPECT TO THIS PRODUCT.
- K. If the original retail purchaser timely complies with the Warranty Procedures described below, and YAESU MUSEN elects to send the purchaser a replacement product rather than repair the "original product", then the Limited Warranty shall apply to the replacement product only for the remainder of the original product Warranty Period.
- L. Warranty statutes vary from state to state, or country to country, so some of the above limitations may not apply to your location.

### Warranty Procedures:

1. To find the Authorized YAESU Service Center in your country/region, visit [www.yaesu.com](http://www.yaesu.com). Contact the YAESU Service Center for specific return and shipping instructions, or contact an authorized YAESU dealer/distributor from whom the product was originally purchased.
2. Include proof of original purchase from an authorized YAESU dealer/distributor, and ship the product, freight prepaid, to the address provided by the YAESU Service Center in your country/ region.
3. Upon receipt of this product, returned in accordance with the procedures described above, by the YAESU Authorized Service Center, all reasonable efforts will be expended by YAESU MUSEN to cause this product to conform to its original specifications. YAESU MUSEN will return the repaired product (or a replacement product) free of charge to the original purchaser. The decision to repair or replace this product is the sole discretion of YAESU MUSEN.

### Other conditions:

YAESU MUSEN'S MAXIMUM LIABILITY SHALL NOT EXCEED THE ACTUAL PURCHASE PRICE PAID FOR THE PRODUCT. IN NO EVENT SHALL YAESU MUSEN BE LIABLE FOR LOSS OF, DAMAGE TO OR CORRUPTION OF STORED DATA, OR FOR SPECIAL, INCIDENTAL, CONSEQUENTIAL, OR INDIRECT DAMAGES, HOW EVER CAUSED; INCLUDING WITHOUT LIMITATION TO THE REPLACEMENT OF EQUIPMENT AND PROPERTY, AND ANY COSTS OF RECOVERING, PROGRAMMING OR REPRODUCING ANY PROGRAM OR DATA STORED IN OR USED WITH THE YAESU PRODUCT.

Some Countries in Europe and some States of the USA do not allow the exclusion or limitation of incidental or consequential damages, or a limitation on how long an implied warranty lasts, so the above limitation or exclusions may not apply. This warranty provides specific rights, there may be other rights available which may vary between countries in Europe or from state to state within the USA.

This Limited Warranty is void if the label bearing the serial number has been removed or defaced.



## YAESU LIMITED WARRANTY

Changes or modifications to this device that are not expressly approved by YAESU MUSEN could void the user's authorization to operate this device.

This device complies with part 15 of the FCC Rules. Operation is subject to the following two conditions: (1) This device may not cause harmful interference, and (2) this device must accept any interference including received, interference that may cause undesired operation.

The scanning receiver in this equipment is incapable of tuning, or readily being altered, by the User to operate within the frequency bands allocated to the Domestic public Cellular Telecommunications Service in Part 22.

The YAESU MUSEN is not responsible for any changes or modifications not expressly approved by the party responsible for compliance. Such modifications could void the user's authority to operate the equipment.

### DECLARATION BY MANUFACTURER

The Scanner receiver is not a digital scanner and is incapable of being converted or modified to a digital scanner receiver by any user.

**WARNING:** MODIFICATION OF THIS DEVICE TO RECEIVE CELLULAR RADIOTELEPHONE SERVICE SIGNALS IS PROHIBITED UNDER FCC RULES AND FEDERAL LAW.

CAN ICES-3 (B) / NMB-3 (B)

This equipment has been tested and found to comply with the limits for a Class B digital device, pursuant to part 15 of the FCC Rules. These limits are designed to provide reasonable protection against harmful interference in a residential installation. This equipment generates, uses, and can radiate radio frequency energy; and, if not installed and used in accordance with the instructions, may cause harmful interference to radio communications. However, there is no guarantee that interference will not occur in a particular installation.

If this equipment does cause harmful interference to radio or television reception, which can be determined by turning the equipment off and on, the user is encouraged to try to correct the interference by one or more of the following measures:

- Reorient or relocate the receiving antenna.
- Increase the separation between the equipment and receiver.
- Connect the equipment into an outlet on a circuit different from that to which the receiver is connected.
- Consult the dealer or an experienced radio/TV technician for help.

This equipment complies with FCC/IC radiation exposure limits and meets the FCC radio frequency (RF) Exposure Guidelines and RSS-102 of the IC radio frequency (RF) Exposure rules. This equipment has very low levels of RF energy that is deemed to comply without testing of specific absorption rate (SAR).

This transmitter must not be co-located or operated in conjunction with any other antenna or transmitter.



# ***YAESU***

## **Declaration of Conformity**

Type of Equipment: VHF FM Transceiver  
Brand Name: YAESU  
Model Number: FT-3185R  
Manufacturer: YAESU MUSEN CO., LTD.  
Address of Manufacturer: Omori Bell port D building 3F, 6-26-3 Minamioi,  
Shinagawa-ku, Tokyo 140-0013 JAPAN

This device complies with part 15 of the FCC Rules. Operation is subject to the following two conditions; (1) this device may not cause harmful interference, and (2) this device must accept any interference received, including interference that may cause undesired operation.

The technical documentation as required by the Conformity Assessment procedures is kept at the following address:

Company: Yaesu U.S.A.  
Address: 6125 Phyllis Drive, Cypress, CA 90630, U.S.A.  
Telephone: (714) 827-7600

## **EU Declaration of Conformity**

We, Yaesu Musen Co. Ltd of Tokyo, Japan, hereby declare that this radio equipment FT-3185E is in full compliance with EU Radio Equipment Directive 2014/53/EU. The full text of the Declaration of Conformity for this product is available to view at <http://www.yaesu.com/jp/red>

## **ATTENTION – Condition of use**

This transceiver operates on frequencies that are regulated. Use of the Transmitter in the EU countries shown in the accompanying table is not permitted without authorization. Users should consult their local spectrum management authority for licensing conditions applicable to this equipment.

|  |    |    |    |    |    |
|---|----|----|----|----|----|
| AT  | BE | BG | CY | CZ | DE |
| DK  | ES | EE | FI | FR | EL |
| HR  | HU | IE | IT | LT | LU |
| LV  | MT | NL | PL | PT | RO |
| SK  | SI | SE | CH | IS | LI |
| NO  | -  | -  | -  | -  | -  |

## **Disposal of Electronic and Electrical Equipment**

Products with the symbol (crossed-out wheeled bin) cannot be disposed as household waste.

Electronic and Electrical Equipment should be recycled at a facility capable of handling these items and their waste by-products.

Please contact a local equipment supplier representative or service center for information about the waste collection system in your country.



# ***YAESU***

***Radio for Professionals***

Copyright 2024  
YAESU MUSEN CO., LTD.  
All rights reserved.

No portion of this manual may be  
reproduced without the permission of  
YAESU MUSEN CO., LTD.

**YAESU MUSEN CO., LTD.**

Omori Bellport Building D-3F  
6-26-3 Minami-Oi, Shinagawa-ku, Tokyo, 140-0013, Japan

**YAESU USA**

6125 Phyllis Drive, Cypress, CA 90630, U.S.A.

**YAESU UK**

Unit 4, Concorde Park, Concorde Way, Segensworth North,  
Fareham, Hampshire PO15 5FG, United Kingdom

2410E-CS-1  
Printed in Japan

