

PHILIPS

NeoPix 140

Home Projector

User Manual



Register your product and get support at
www.philips.com/support



Table of contents

Introduction	3	6 Wired projection	13
Dear customer	3	7 Wireless projection	14
About this user manual.....	3	Wireless projection with Android devices/ Windows computers	14
What's in the box	3	Wireless projection with iOS devices/Mac computers	15
Customer service center	3	Stream media using DLNA.....	16
1 General safety information	4	8 Access a Wi-Fi network	17
Setting up the product	4	Connect to a Wi-Fi network	17
Repairs	4	Disconnect from a Wi-Fi network.....	17
Power supply	5	Reconnect to a Wi-Fi network.....	17
2 Overview	5	Turn Wi-Fi on or off	18
Left side view	5	9 Change projector settings	18
Front view.....	5	10 Maintenance	20
Right side view	6	Cleaning.....	20
Top view.....	6	Update software	20
Remote control.....	6	11 Troubleshooting	21
3 Initial setup	7	12 Appendixes	23
Install the projector.....	7	Technical data	23
Connect to power supply	8	CE statement	24
Prepare the remote control	8	FCC statement.....	24
Power on and set up the projector	9	Canada regulatory compliance.....	24
Select the language.....	10	Other notice.....	25
4 Connect to other devices	10		
Connect to a playback device through HDMI™	10		
Connect to a dongle.....	11		
Connect to wired speakers or headphones.....	11		
5 Play/view media from USB storage devices	12		
Connect a USB storage device	12		
Play videos.....	12		
View images	12		
Play audios	13		
View text files.....	13		

Introduction

Dear customer

Thank you for purchasing this projector.
We hope you enjoy this product and the many functions it offers!

About this user manual

The quick start guide supplied with this product allows you to start using this product quickly and easily. Detailed descriptions can be found in the following sections of this user manual.

Read the entire user manual carefully. Follow all safety instructions in order to ensure proper operation of this product (see **General safety information, page 4**). The manufacturer accepts no liability if these instructions are not followed.

Symbols used

Notice

 This symbol indicates tips that will help you use this product more effectively and easily.

DANGER!



Danger of personal injury!

This symbol gives warning of danger of personal injury. Physical injury or damage can result from improper handling.

CAUTION!



Damage to the product or loss of data!

This symbol gives warning of damage to the product and possible loss of data. Damage can result from improper handling.

What's in the box

- ① NeoPix 140 projector (NPX140/INT)
- ② Remote control
- ③ AAA batteries x 2
- ④ Quick Start Guide with Warranty Card
- ⑤ Power plug adapters x 4
- ⑥ AC adapter

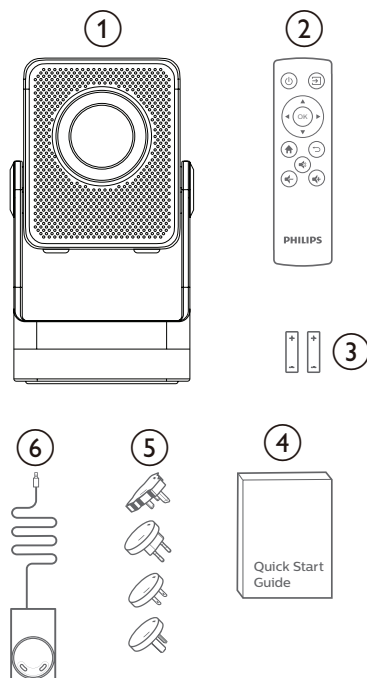

Customer service center

The Support page, warranty card, and user manuals can be found here:

Web: www.philips.com/support

Support Contacts:

International Phone: +41 215 391 665

Please ask your provider for international call costs!

Mail: support@philipsprojection.com

Access our FAQ websites:

<https://support.philipsprojection.com>

<https://community.philipsprojection.com>

1 General safety information

Take note of all warning and safety notes indicated. Do not make any changes or settings that are not described in this user manual. Incorrect operation, and improper handling can lead to physical injury, damage to the product or loss of data.

Setting up the product

This product is for indoor use only. Place the product securely on a stable, flat surface. To help avoid possible injuries to persons or damage to the product itself, position all cables in such a way that no one will trip over them.

Do not operate the product in damp rooms. Never touch the mains cable or the mains connection with wet hands.

Never operate the product immediately after moving it from a cold location to a hot location. When the product is exposed to such a change in temperature, moisture may condense on the crucial internal parts.

The product must have sufficient ventilation and must not be covered. Do not put the product in closed cabinets, boxes, or other enclosures when in use.

Protect the product from direct sunlight, heat, intense temperature fluctuations and moisture. Do not place the product in the vicinity of heaters or air conditioners. Observe the information on temperature listed in the technical data (see **Technical data, page 23**).

Prolonged operation of the product causes the surface to become hot. In case of overheating, the product automatically switches to standby mode.

Do not allow liquids to leak into the product. Turn off the product and disconnect it from the mains supply if liquids or foreign substances leaked into the product. Have the product inspected by an authorised service center.

Always handle the product with care. Avoid touching the lens. Never place heavy or sharp objects on the product or on the power cable.

If the product gets too hot or emits smoke, shut it down immediately and unplug the power cable. Have your product checked by an authorised service center. Keep the product away from open flames (e.g. candles).

DANGER!



Risk of explosion with incorrect type of batteries!

There is a risk of explosion if the wrong battery type is used.

Do not expose the batteries (battery pack or embedded batteries) to excessive heat such as sunshine, or open fire.

Under the following conditions, a layer of moisture can appear inside the product which can lead to malfunctions:

- if the product is moved from a cold to a warm area;
- after a cold room is heated;
- when the product is placed in a damp room.

Proceed as follows to avoid any moisture buildup:

- 1 Seal the product in a plastic bag before moving it to another room, in order for it to adapt to room conditions.
- 2 Wait one to two hours before you take the product out of the plastic bag.

Do not use or store the device in a dusty environment. Dust particles and other foreign objects can damage the device, which will void the product warranty.

Do not expose the product to extreme vibrations. This may damage the internal components.

Do not allow children to handle the product without supervision. The packing materials should be kept out of the hands of children.

For your own safety, do not use the product during thunderstorms with lightning.

Repairs

Do not repair the product yourself. Improper maintenance can result in injuries or damage to the product. The product must be repaired by an authorised service center.

Please find the details of authorised service centers on the warranty card supplied with this product.

Do not remove the type label from this product, as this will void the warranty.

Power supply

Use only a power adapter which is certified for this product (see **Technical data, page 23**). Check whether the mains voltage of the power supply matches the mains voltage available at the setup location. This product complies with the voltage type specified on the product.

The power outlet shall be installed near the product and shall be easily accessible.

CAUTION!



Always use the  button to turn the projector off.

Turn off the product and unplug from the power outlet before cleaning the surface (see **Cleaning, page 20**). Use a soft, lint-free cloth. Never use liquid, gaseous or easily flammable cleaners (sprays, abrasives, polishes, alcohol). Do not allow any moisture to reach the interior of the product.

DANGER!





Risk of eye irritation!

This product is equipped with a high power LED (Light Emitting Diode), which emits very bright light. Do not look directly into the projector lens during operation. This could cause eye irritation or damage.

2 Overview

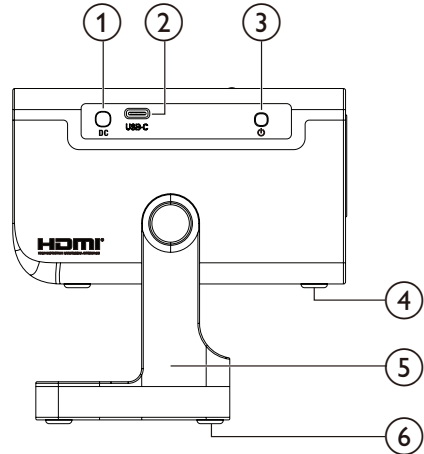
Left side view



- ① **DC**
Connect to the supplied AC adapter.
- ② **USB-C**
Connect to a USB power source such as a USB power adapter or power bank.
- ③ 
 - Switch the projector on or to standby mode.
 - When the projector is on, the LED lights up in white.
 - When the projector is in standby mode, the LED lights up in red.
- ④ **Foot pad**
- ⑤ **Rotating stand**
- ⑥ **Foot pad**

Front view

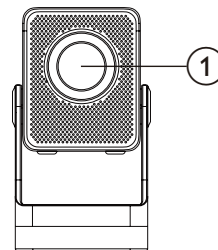

- ① **Projection lens**

Right side view

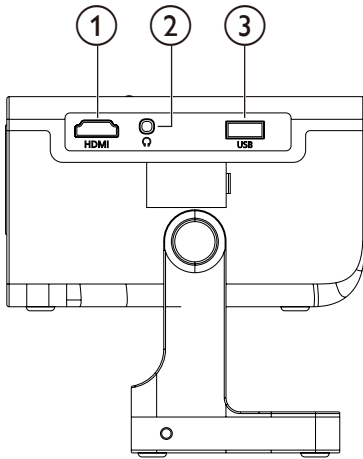

- ① **HDMI**
Connect to an HDMI™ output port on a playback device.
- ② 
3.5 mm audio output; connect to external speakers or headphones.
- ③ **USB**
Connect to a USB storage device or dongle.



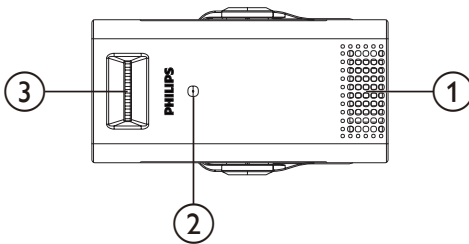



Top view

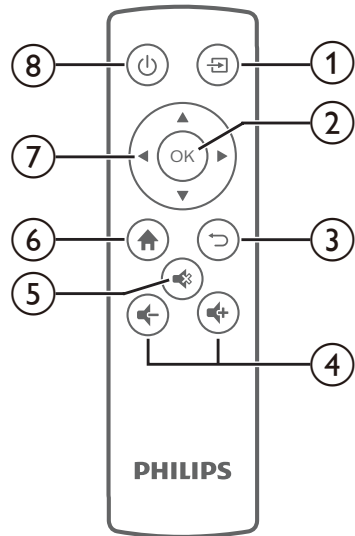

- ① **Air vent**
- ② **IR sensor**
- ③ **Focus adjustment knob**
Adjust image sharpness.

Remote control



- ① 
Display all the input sources and allow you to switch to a different input source.
- ② **OK**
Confirm a selection or change the value for the current setting.
- ③ 
Return to the previous screen.
- ④ 
Increase or decrease the volume.
- ⑤ 
Mute or unmute the speaker.
- ⑥ 
Access the home screen.
- ⑦ **Navigation buttons (Up, Down, Left, Right)**
 - Navigate items on the screen.
 - Press ▲/▼ or ◀/▶ to change the value for the current setting.
- ⑧ 
Switch the projector on or to standby mode.

3 Initial setup

Notice

i Make sure all devices are disconnected from their power supplies before establishing or changing any connections.

Install the projector

You can install the projector in four different ways. Follow the guidelines below to correctly install the projector.

Notice

i For overhead mounting on ceiling, purchase a projector mount recommended by an installation professional and follow the instructions that come with the mount.

Before mounting on the ceiling, make sure the ceiling can support the weight of the projector and mounting kit.

For ceiling installation, this product must be securely attached to the ceiling in accordance with the installation instructions. An improper ceiling installation may result in accident, injury or damage.

Front

- 1 Place the projector on a flat surface such as a table in front of the projection surface. This is the most common way to position the projector for quick setup and portability.

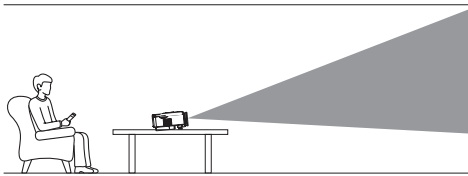

- 2 If the projection direction is incorrect, select **Settings** from the home screen to open the settings menu, go to *Display > Projection mode*, and press the **OK** button to select *Front*.

Front Ceiling

- 1 Mount the projector on the ceiling with upside up in front of the projection screen. A projector mount is required to mount the projector on ceiling.

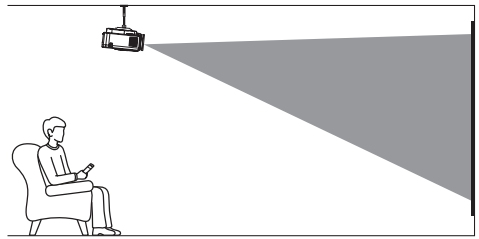

- 2 If the projection direction is incorrect, select **Settings** from the home screen to open the settings menu, go to *Display > Projection mode*, and press the **OK** button to select *Front Ceiling*.

Rear

- 1 Place the projector on a table behind the projection screen. A special rear projection screen is required.

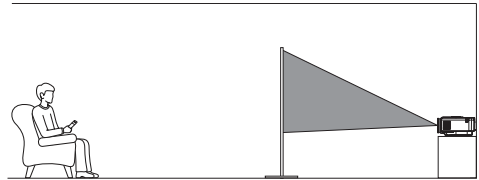

- 2 If the projection direction is incorrect, select **Settings** from the home screen to open the settings menu, go to *Display > Projection mode*, and press the **OK** button to select *Rear*.

Rear Ceiling

- 1 Mount the projector on ceiling with upside up behind the projection screen. To mount the projector on ceiling behind the screen, a projector mount and a special rear projection screen are required.

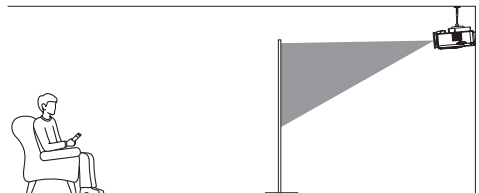

- 2 If the projection direction is incorrect, select **Settings** from the home screen to open the settings menu, go to *Display > Projection mode*, and press the **OK** button to select *Rear Ceiling*.

Connect to power supply

CAUTION!

- i** Always use the  button to turn the projector on and off.

Connect to the supplied AC adapter

The recommended way to power the projector is by connecting it to the supplied AC adapter.

- 1 Connect the AC adapter to the **DC** power jack on the left side of the projector.
- 2 Attach a suitable power plug adapter to the AC adapter and plug the AC adapter into an electrical socket.
 - The power LED on the projector lights up in red.

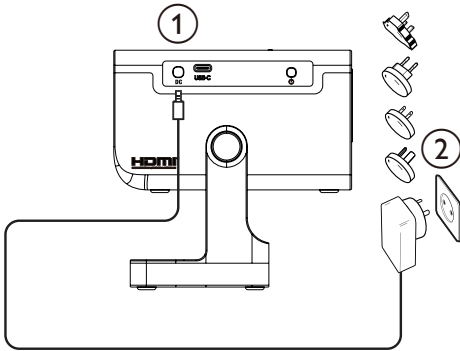

Connect to a USB power source

You can also power the projector by connecting it to a USB power source such as a USB power adapter or power bank. **Note:** The USB power source must have an output voltage of 5 V, 9 V, or 12 V and an output power of more than 10 W.

- 1 Connect a USB power source to the **USB-C** port on the left side of the projector.
- 2 If needed, connect the USB power source to an electrical socket or turn it on.
 - The power LED on the projector lights up in red.

Prepare the remote control

CAUTION!

- i** The improper use of batteries can lead to overheating, explosion, risk of fire and injury. Leaking batteries can possibly damage the remote control.
 - Never expose the remote control to direct sunlight.
 - Avoid deforming, dismantling or charging the batteries.
 - Avoid exposure to open fire and water.
 - Replace empty batteries immediately.
 - Remove the batteries from the remote control if not in use for long periods of time.

- 1 Open the battery compartment.
- 2 Insert the supplied batteries (type AAA) with correct polarity (+/-) indicated.
- 3 Close the battery compartment.

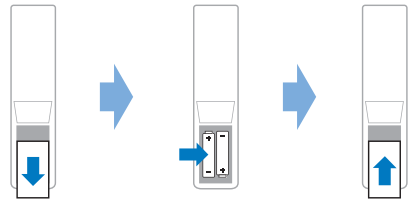

- When using a remote control with infrared signals, point the remote control at the IR sensor on the projector, and make sure there is no obstacle between the remote control and the IR sensor.

Power on and set up the projector

Power on/off the projector

- To turn on the projector, press  on the projector/remote control. The power LED on the projector turns from red to white.

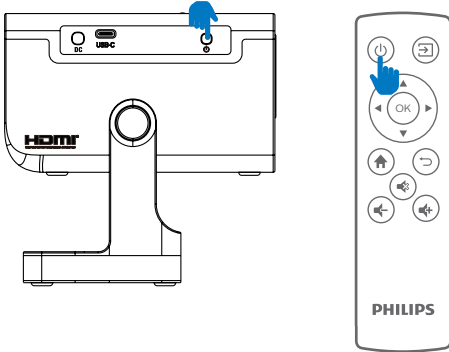

- To turn off the projector, press  on the projector/remote control 3 times. The projector enters standby mode and its power LED turns from white to red.
- To fully shut down the projector, disconnect it from the power supply.

Image focus adjustment

To adjust the image focus (sharpness), turn the focus adjustment knob above the projection lens.

Tip: If you change the projection distance later, you'll need to adjust the image focus again.

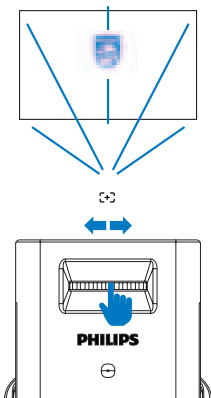

Screen size adjustment

The projection screen size (or size of images) is determined by the distance between the lens of the projector and the projection surface.

This projector has a recommended projection distance of 210 cm (85"), and thus creates a maximum screen size of 100" (230 cm). The minimum distance from the projection surface is 85 cm (35").

Digital zooming

You can use the digital zooming function to reduce the screen size. You can scale down the screen to up to 50% of its full size.

- Select **Settings** from the home screen to open the settings menu, go to *Display > Window Zoom*, and press the **OK** button. A new screen then appears.
- To adjust the screen size, highlight **Zoom-** or **Zoom+** on the screen and then press the **OK** button. To reset the screen size, highlight **Reset** and then press the **OK** button.

Projection direction adjustment

You can adjust the projection direction by rotating the main body around the pivot of the stand. The main body can rotate by up to 135°.

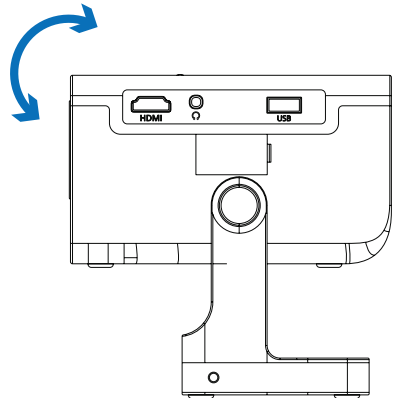

Image shape adjustment

Auto keystone correction

By default, auto keystone correction is on and the projector automatically makes the image rectangular every time it turns on or detects a change in its position or angle.

If auto keystone correction is off, follow the following steps to turn it on. **Tip:** You can follow

the same steps to turn off auto keystone.

- 1 Select **Settings** from the home screen to open the settings menu and go to *Display > Automatic vertical keystone*.
- 2 Press the **OK** button to turn on auto keystone correction.

Manual keystone correction

You can manually make the image rectangular by adjusting the vertical keystone angles.

- 1 Select **Settings** from the home screen to open the settings menu, go to *Display > keystone*, and press the **OK** button. A new screen then appears.
- 2 To adjust the image shape, highlight + or - on the screen and then press the **OK** button. To reset the image shape, highlight *Reset* and then press the **OK** button.

Select the language

When you turn on the projector for the first time or after it was reset to its factory default settings, the projector system will start and prompt you to select the language.

Press the navigation buttons to select your preferred display language and press the **OK** button to confirm.

After selecting the language, you can start using the projector or continue to make other adjustments.

Tip: To change the language later, select **Settings** from the home screen to open the settings menu, go to *Options > Menu language*, and press the **OK** button.

You will see the home screen shown below after selecting the language.





4 Connect to other devices

Connect to a playback device through HDMI™

You can connect a playback device (e.g. a Blu-ray player, gaming console, camcorder, digital camera or PC) to the projector through HDMI™ connection. With this connection, images are shown on the projection screen, and audio is played on the projector.

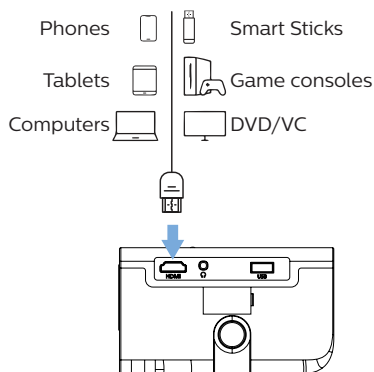
- 1 Using an HDMI™ cable, connect the **HDMI** port on the projector to an HDMI™ output port on a playback device.



- 2 If the projector doesn't automatically switch to the correct input source, select **HDMI** from the home screen, or press  on the remote control and select *HDMI*.



Connect to a dongle

You can connect a dongle (e.g. Amazon Fire Stick, Roku Stick and Chromecast) to the projector to easily watch videos over the internet. With this connection, images are shown on the projection screen, and audio is played on the projector.

- 1 Connect the dongle to the projector's **HDMI** port directly or using an HDMI™ cable.
- 2 Connect the dongle to the projector's **USB** port using a USB cable. **Note:** The maximum current supplied by this port is 5V1A.

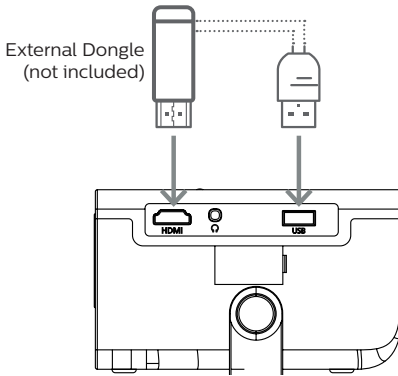

- 3 If the projector doesn't automatically switch to the correct input source, select **HDMI** from the home screen, or press  on the remote control and select *HDMI*.

Connect to wired speakers or headphones

You can connect wired speakers or headphones to the projector. With this connection, audio from the projector is played through the external speakers or headphones.

- The internal speakers of the projector are deactivated automatically when external speakers or headphones are connected to the projector.



DANGER!





Danger of hearing damage!

Before connecting the headphones, turn down the volume on the projector.

Do not use the projector over a longer time at high volume – especially when using headphones. This could lead to hearing damage.

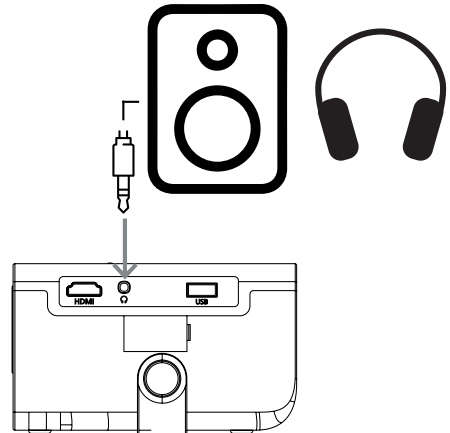
- 1 Using a 3.5 mm audio cable, connect the  jack on the projector to the analogue audio input (3.5 mm jack, or red and white jacks) on external speakers. Or connect the  jack on the projector to headphones.



- 2 After connecting the speakers or headphones, press  on the remote control to adjust the volume to the desired level.

5 Play/view media from USB storage devices

The projector has an integrated media player. Using this media player, you can play/view videos, audios, images or text files stored on a USB storage device.

Supported file formats

The integrated media player supports the following file formats.

- Video formats: MP4, RMVB, AVI, RM, MKV
- Audio formats: MP3, WMA, OGG, FLAC, WAV
- Image formats: BMP, PNG, JPEG

Connect a USB storage device

Notice



The projector supports a USB storage device that is formatted for FAT16 or FAT32 file system.

- 1 Make sure your USB storage device contains media or text files supported by the integrated media player.
- 2 Connect your USB storage device to the **USB** port on the projector.

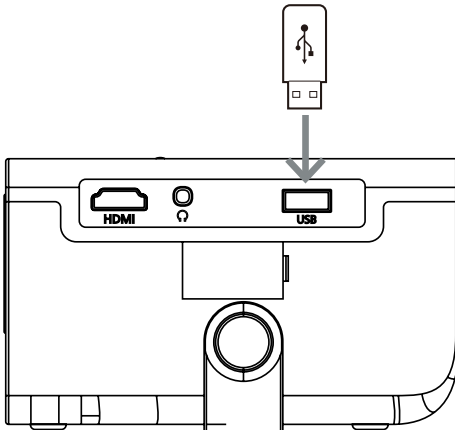

Play videos

- 1 From the projector's home screen, select **Movie**.
- 2 Press the **OK** button to open the USB storage device. **Note:** Only supported video files are displayed on the screen. All folders and files are ordered alphabetically by name.
- 3 Press the navigation buttons on the remote control to select a video file or a folder. To open a selected folder, press the **OK** button. To return to the parent folder, press **↶** or select **Back** on the screen.
- 4 Press the **OK** button to start playing the selected video file.
- 5 When a video file is playing, you can press **◀▶** to skip to the previous or next video file in the current folder. You can also press **▲** to open the projector's settings menu. To hide the menu, press **↶**.

While a video file is playing, you can press the **OK** button or **▼** to bring up the control bar at the bottom of the screen. The control bar will automatically disappear in 5 seconds. To instantly hide the control bar, press **▼** or **↶**.

While the control bar is visible, press **▲** to select the progress bar and then press **◀▶** to quickly rewind or fast-forward the video.

While the control bar is visible, press **◀▶** to select an option and then press **OK** to confirm the action or change the value. To close the dialog box of an option, press **↶**.

- 6 To stop playing a video file and return to the list of files in the current folder, press **↶** on the remote control.

View images

You can view images in a similar way as you play videos. The major differences are:

- In Step 1, you need to select **Photo** instead of **Movie**.
- In Step 4, after you press the **OK** button, the projector starts the slide show of all supported images in the current folder from the selected image.
- You cannot change the speed of the slide show.

Play audios

You can play audios in a similar way as you play videos. The major differences are:

- In Step 1, you need to select **Music** instead of **Movie**.
- When an audio is playing, you will always see the changing sound wave on the screen.

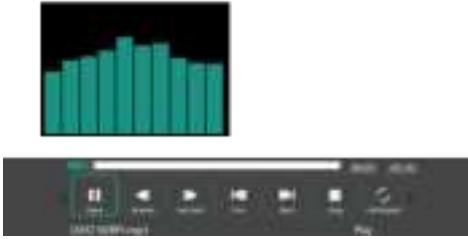

View text files

You can view text files in a similar way as you view images. The major differences are:

- In Step 1, you need to select **Text** instead of **Photo**.
- In Step 4, after you press the **OK** button, the projector opens the selected text file and displays the first page of it. The projector doesn't automatically scroll down or open the next file.
- The control bar will automatically disappear in 15 seconds. You can instantly hide it by pressing ▼ or ↶, or show it again by pressing the **OK** button.
- When viewing a text file, you can press the **OK** button or ◀▶ to bring up the control bar at the bottom of the screen.
- Press ▲/▼ to view the previous or next page of the text file.
- When viewing a text file, you cannot open the projector's settings menu.

6 Wired projection

This projector can mirror the screens of an iOS device (iPhone, iPad or iPod touch) to the projection screen when the two devices are connected by cable.

- 1 From the projector's home screen, select **iOS Wired Mirroring** to activate the screen mirroring function.



- 2 Connect your iOS device to the **USB** port of the projector using your iOS device's original data cable.
- 3 If your iOS device screen shows a dialog box, select **Trust** to continue.
- 4 If your iOS device prompts you to enter the passcode, enter the passcode to continue.
- 5 The screen mirroring will start in a few seconds.

7 Wireless projection

This projector can wirelessly mirror the screens of the following devices to the projection screen.

- Android devices
- Windows computers
- iOS devices (iPhone, iPad and iPod touch)
- Mac computers

Notice



For better streaming performance, use a 5 GHz Wi-Fi network.

Copyright-protected content from Netflix, Amazon Prime Video, Hulu, etc. cannot be streamed.

The steps below might vary slightly depending on the version of your operating system and your device.

Wireless projection with Android devices/Windows computers

What you need

- An Android device or Windows computer that supports Miracast. **Note:** This feature is also called Screen Cast, Screen Sharing, Wireless Display, Wireless projection, etc. Not all devices have this feature. Refer to your device user manual for details.
- 1 Make sure the projector's Wi-Fi is on. To learn how to turn on Wi-Fi, see **Turn Wi-Fi on or off, page 18**. **Tip:** You do not need to connect the projector to a Wi-Fi network to use screen mirroring.
 - 2 Make sure you have turned on Wi-Fi on your Android device or Windows computer. **Tip:** You do not need to connect your device to a Wi-Fi network to use screen mirroring. But, connecting it to a Wi-Fi network will allow it to access the internet via Wi-Fi while its screen is being mirrored.
 - 3 From the projector's home screen, select **Wi-Fi Mirroring** to activate the screen mirroring function.
 - The projector displays its device name and the status of the connection with your device on the screen.



- 4 On your Android device, access the “Settings” menu and then select the setting for wireless display or projection.

Or on your Windows 10 computer, select the **action center** icon in the lower-right corner of the screen and then select **Connect**.

Your device will automatically scan for and display the available display devices.

- 5 On your Android device or Windows computer, select the projector to make a connection and start mirroring your device's screen. **Note:** You may need to wait a few seconds for the screen mirroring to start.



Wireless projection with iOS devices/Mac computers

Method 1

With this method, your iOS device cannot access the internet via Wi-Fi while its screen is being wirelessly mirrored.

What you need

- An iOS device such as an iPhone or a Mac computer.
- 1 Make sure the projector's Wi-Fi is on and the projector is not connected to any Wi-Fi network. To learn how to turn on Wi-Fi and disconnect from a Wi-Fi network, see **Access a Wi-Fi network, page 17**.
 - 2 From the projector's home screen, select **Wi-Fi Mirroring** to activate the screen mirroring function.
 - The projector displays the device name and password for connecting to its Wi-Fi network (hotspot), as well as the status of the connection with your device.
 - 3 On your iOS device, go to **Settings > Wi-Fi** and turn on Wi-Fi if it's off. Or on your Mac computer, click the Wi-Fi icon  in the menu bar and turn on Wi-Fi if it's off. The list of available Wi-Fi networks is displayed.
 - 4 On your iOS device or Mac computer, select the name of the projector's Wi-Fi network, enter the password displayed on the projector screen, and select **Join**.



- 5 On your iOS device, open Control Center.
 - On iPhone X or later or iPad with iPadOS 13 or later: Swipe down from the upper-right corner of the screen.
 - On iPhone 8 or earlier or iOS 11 or earlier: Swipe up from the bottom edge of the screen.

Or on your Mac computer, select the AirPlay status icon  in the menu bar, which is near the upper-right corner of the screen.

- 6 On your iOS device, tap Screen Mirroring  in Control Center and select the projector to start mirroring your iOS device's screen.

Or on your Mac computer, select the projector to start mirroring your Mac computer's screen.



Note: You may need to wait a few seconds for the screen mirroring to start.



Method 2

With this method, your iOS device can access the internet via Wi-Fi while its screen is being wirelessly mirrored.

What you need

- An iOS device such as an iPhone or a Mac computer.
- 1 Make sure you have connected the projector and your iOS device or Mac computer to the same Wi-Fi network. To learn how to connect the projector to a Wi-Fi network, see **Connect to a Wi-Fi network, page 17**.
 - 2 From the projector's home screen, select **Wi-Fi Mirroring** to activate the screen mirroring function.
 - The projector displays its device name and the status of the connection with your device on the screen.
 - 3 On your iOS device, open Control Center.
 - On iPhone X or later or iPad with iPadOS 13 or later: Swipe down from the upper-right corner of the screen.
 - On iPhone 8 or earlier or iOS 11 or earlier: Swipe up from the bottom edge of the screen.
- Or on your Mac computer, select the AirPlay status icon  in the menu bar, which is near the upper-right corner of the screen.
- 4 On your iOS device, tap Screen Mirroring  in Control Center and select the projector to start mirroring your iOS device's screen.
- Or on your Mac computer, select the projector to start mirroring your Mac computer's screen.

Note: You may need to wait a few seconds for the screen mirroring to start.

Stream media using DLNA

What you need

- A smart device (e.g. a smartphone or tablet) with DLNA-supported media apps installed.
- 1 Make sure you have connected the projector and your smart device to the same Wi-Fi network. To learn how to connect the projector to a Wi-Fi network, see **Connect to a Wi-Fi network, page 17**.
 - 2 From the projector's home screen, select **DLNA** to activate the screen mirroring function.
 - The projector displays its device name and the status of its Wi-Fi connection on the screen.

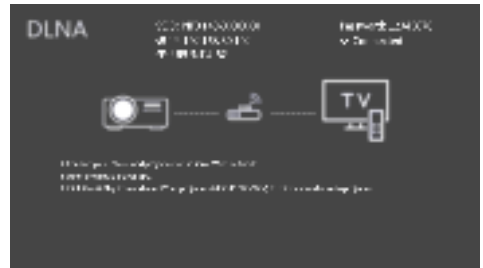

- 3 On your smart device, while playing a video/audio or viewing a picture in a DLNA-supported media app, tap or click the screen to show the controls if they are invisible.
- 4 On your smart device, select the TV icon.
- 5 On your smart device, select the projector to start streaming the video, audio or picture. **Note:** You may need to wait a few seconds for the streaming to start.

8 Access a Wi-Fi network

Connect to a Wi-Fi network

You can connect the projector to the same Wi-Fi network as your iOS device. With this connection, your iOS device can access the internet via Wi-Fi while its screen is being wirelessly mirrored. In addition, you can update the projector software online with this connection.

Note: An Android device can access the internet via Wi-Fi while its screen is being wirelessly mirrored, even when the projector is not connected to a Wi-Fi network.

What you need

- A wireless router connected to the internet. For best wireless performance and coverage, use an 802.11n router (“Wi-Fi 4”).
- 1 Select **Wi-Fi** from the home screen to open the Wi-Fi settings screen. If Wi-Fi is off, press the **OK** button to turn on Wi-Fi.



- 2 The projector will scan for and display the available Wi-Fi networks. The network with the strongest signal appears at the top of the list.
- 3 Press the navigation buttons to highlight a network from the list of available Wi-Fi networks and press the **OK** button. You are prompted to enter the password for connecting to the network using the on-screen keyboard.
- 4 Enter the correct password using the navigation buttons and **OK** button.
- 5 Highlight the check mark on the keyboard and press the **OK** button.
- 6 Wait a few seconds for the connection to be established. After the connection is established, the connected Wi-Fi network

will appear at the top of the screen and its status will become *Connected*.

Tip: When the projector is connected to a Wi-Fi network, a white Wi-Fi icon appears near the upper-right corner of the home screen.

Disconnect from a Wi-Fi network

- 1 Select **Wi-Fi** from the home screen to open the Wi-Fi settings screen. The projector will scan for and display the available Wi-Fi networks.
- 2 Press the navigation buttons to highlight the connected Wi-Fi network and press the **OK** button. A dialog box appears.
- 3 Highlight the **Disconnect** button and press the **OK** button to disconnect the projector from the connected Wi-Fi network and close the dialog box. This network will move to the list under **Saved Wi-Fi**.

Note: After you disconnect a Wi-Fi network, the projector will remember its password, unless you factory reset the projector.

Reconnect to a Wi-Fi network

When you turn on the projector again, the projector will automatically try to reconnect to the last connected Wi-Fi network, unless you factory reset the projector.

To manually reconnect to other previously connected Wi-Fi networks, follow these steps:

- 1 Select **Wi-Fi** from the home screen to open the Wi-Fi settings screen. The projector will scan for and display the available Wi-Fi networks.
- 2 Press the navigation buttons to highlight a Wi-Fi network in the list under **Saved Wi-Fi** and press the **OK** button. A dialog box appears.
- 3 Highlight the **Connect** button and press the **OK** button. Another dialog box appears.
- 4 To use the saved password for the reconnection, highlight the **No** button and press the **OK** button. To reenter the password, highlight the **Yes** button, press the **OK** button, and do Steps 4 and 5 in **Connect to a Wi-Fi network, page 17**.
- 5 Wait a few seconds for the connection to be established.

Turn Wi-Fi on or off

Wi-Fi is off by default. To turn it on or off, highlight the toggle on the left of the Wi-Fi settings screen and press the **OK** button.



9 Change projector settings

This section helps you change the projector settings using the settings menu.

- 1 Select **Settings** from the home screen to open the settings menu.
- 2 Use the navigation buttons and the **OK** button to select a menu item. Press **↶** to return to the previous level of the menu tree.
- 3 Press **▲/▼**, **◀▶** or the **OK** button to select a value for the menu item.
- 4 Press the **OK** button to make the change.
Note: For some menu items such as *Contrast*, the change takes effect once you select a different value.
- 5 Press **↶** one or more times or **⬆** to exit the settings menu.

Picture settings

You can view and change the following picture settings.



- *Image Mode:* Select predefined color settings for picture or video display. Select *User* to customize the following settings:
 - *Contrast:* Adjust the contrast of the projected image.
 - *Brightness:* Adjust the overall brightness of the projected image.
 - *Color:* Adjust the color saturation of the projected image.
 - *Sharpness:* Adjust the clarity of detail in the projected image.
- *Color Temperature:* You can set the projector to use the following color temperature types.
 - *Cold:* Make the picture more bluish.
 - *Standard:* Use a moderate color temperature.

- *Warm*: Make the picture more reddish.

Sound settings

You can view and change the following sound settings.



- *Sound Mode*: You can set the projector to use the following sound modes, depending on your environment, audio type or preferences.
 - *Standard*: Optimize the bass and treble levels for general audio.
 - *Music*: Optimize the bass and treble levels for music.
 - *Movie*: Optimize the bass and treble levels for movies.
 - *Sports*: Optimize the bass and treble levels for sports.
 - *User*: Define your own bass and treble levels.
- *Treble*: Set the treble level. This menu item is enabled only when the sound mode is *User*.
- *Bass*: Set the bass level. This menu item is enabled only when the sound mode is *User*.
- *Balance*: Adjust the stereo balance to compensate for volume differences between the left and right speakers at the listening position.

Display settings

You can view and change the following display settings.



- *Projection mode*: Adjust the projection to the correct direction based on how the projector is installed.
- *Window Zoom*: Scale down the screen to up to 50% of its full size. The default value is 100% (no scale-down).
- *Keystone*: Manually make the image rectangular by adjusting the vertical and horizontal keystone angles.
- *Automatic vertical keystone*: Choose to toggle auto keystone correction on or off.

Other settings

You can view and change the following additional settings.



- *Menu language*: Select your preferred display language.
- *Factory Reset*: Restore the projector's settings to the factory default settings. After the factory reset, the projector will restart and allow you to set it up as new.
- *Software Upgrade*: Update the projector's software offline. For more details, see **Update software offline, page 20**.
- *Auto Sleep*: Select a period of time after which the projector turns off automatically. The default value is *Off*.
- *Timer*: Select a period of time after which the settings menu automatically closes. The default value is *15s*. If you select *Off*, the menu won't automatically close.
- *Network Upgrade*: Update the projector's software online. For more details, see **Update software online, page 20**.
- *Version Info*: View the software version of this product.

10 Maintenance

Cleaning

DANGER!



Follow the following instructions when cleaning the projector:

Use a soft, lint-free cloth. Never use liquid or easily flammable cleansers (sprays, abrasives, polishes, alcohol, etc.). Do not allow any moisture to reach the interior of the projector. Do not spray the projector with any cleaning fluids.

Wipe over the surfaces gently. Be careful that you do not scratch the surfaces.

Cleaning the lens

Use a soft brush or lens cleaning paper for cleaning the lens of the projector.

DANGER!



Do not use any liquid cleaning agents!

Do not use any liquid cleaning agents for cleaning the lens, to avoid damaging the coating film on the lens.

Update software

You can update the projector software online or offline to get the best features and support from the projector.

CAUTION!



Do not turn off the projector or remove the USB flash drive during a software update.

Update software online

Updating the projector software online is quick and easy.

- 1 Make sure the projector can access the internet via a Wi-Fi network. To learn how to connect the projector to a Wi-Fi network, see **Connect to a Wi-Fi network, page 17**.
- 2 Select **Settings** from the home screen to open the settings menu and then select *Options > Network Upgrade*. The projector will automatically check for a new version of projector software. If a new version is found, the projector will prompt you to start the update.
- 3 If a new version is found, follow the on-screen instructions to complete the update.

Update software offline

- 1 Visit www.philips.com/support, find your product (model number: **NPX140/INT**), open its support page and locate "**Software & drivers**".
- 2 From the support page you opened in step 1, download the software installation file to a USB flash drive. Unzip the downloaded file and save the resulting file in the root directory of the USB flash drive.
- 3 Connect the USB flash drive to the projector.
- 4 Select **Settings** from the home screen to open the settings menu and then select *Options > Software Upgrade*.
- 5 Follow the on-screen instructions to complete the update.

11 Troubleshooting

Power cycling

If a problem occurs and you cannot resolve it using the instructions in this user manual, try the following steps to resolve the problem.

- 1 Turn the projector off by pressing \odot .
- 2 Wait at least 10 seconds.
- 3 Turn the projector on by pressing \odot .
- 4 If the problem persists, contact one of our customer service centers or your dealer.

Problem	Solution
The projector cannot be turned on.	<ul style="list-style-type: none">• Disconnect and reconnect the power cable, and try to turn the projector on again.
The projector cannot be turned off.	<ul style="list-style-type: none">• Press and hold \odot longer than ten seconds. If this does not work, disconnect the power cable.
No image from the external HDMI™ device.	<ol style="list-style-type: none">1. Check if you have switched the input source to <i>HDMI</i>.2. Disconnect the HDMI™ cable or switch off the HDMI™ device.3. Wait three seconds.4. Reconnect the HDMI™ cable or switch on the HDMI™ device again.
No sound from the external connected device.	<ul style="list-style-type: none">• Check the cables to the external device.• Check that the sound is activated on the external device.• Only the original cables from the device manufacturer may function.
No sound from external HDMI™ output device.	<ul style="list-style-type: none">• On the HDMI™ output device, set the audio setting to Multichannel (Raw data) & Stereo (PCM).
No sound when you connect your computer using an HDMI™ cable.	<ul style="list-style-type: none">• Check that the sound is activated on the computer.
Only the home menu appears and not the image from the external device.	<ul style="list-style-type: none">• Check if the cables are connected to the correct sockets.• Check that the external device is turned on.• Check if the video output of the external device is turned on.
Only the home menu appears and not the image from the connected computer.	<ul style="list-style-type: none">• Check that the HDMI™ output of the computer is turned on.• Check if the resolution of the computer is set to 1920*1080.
The projector turns itself off.	<ul style="list-style-type: none">• When the projector is running for a long period of time, the surface becomes hot.• Check that the power cable is connected correctly.
The projector cannot read the USB storage device.	<ul style="list-style-type: none">• The projector does not support the exFAT file system.• Format the USB storage device in FAT32 or NTFS format, then use it.

Problem	Solution
The projector does not react to remote control commands.	<ul style="list-style-type: none"> • Check the batteries of the remote control.
The temperature of the projector's surface is warm.	<ul style="list-style-type: none"> • For this projector it is normal to generate moderate heat during operation.
The projector does not work after I connect it to a laptop.	<ul style="list-style-type: none"> • Check that the HDMI™ cable is plugged in correctly. • Make sure that the laptop has been switched to projector display.
Black / White Pixels	<p>An LCD display may contain a small number of pixels that do not function normally (also known as “dead pixels” or “black pixels”). Your display has been inspected and is in compliance with the manufacturer’s specifications, meaning that any pixel defects do not affect the operation or use of your display. Without prejudice to generality of the foregoing, dead pixels or black pixels not exceeding 5 dots meet the factory specifications and are not considered a defect under this warranty.</p> <p>Dust Deposit – Warranty Exclusion:</p> <p>Dust may accumulate inside the projector over time. This can affect the image quality and even disrupt the functioning of the device. However, this phenomenon is not considered a defect under this warranty.</p> <p>We recommend regularly cleaning the lens with a soft cloth suitable for glass cleaning. You can also push dry air through the air vents to remove dust from the optical engine inside the device.</p>

12 Appendixes

Technical data

Technology/optical

Display technology	LCD
Light source	single LED W
Brightness	150 ANSI Lumens
Resolution	1280 x 720 pixels
LED lifetime	over 30,000 hours
Contrast ratio	1000:1
Aspect ratio	16:9
Throw ratio	1.075:1
Screen size (diagonal)	35-100"
Screen distance	0.85-4 m
Projection modes	4
Focus adjustment	manual
Keystone correction	vertical automatic
Sleep timer	yes

Sound

Built-in speaker	3 W
Speaker type	Mono

Connection

HDMI™ in	x1
USB-A (5 V/1 A out + external drive)	x1
USB-C (supports 5/9/12 V power in)	x1
3.5 mm audio out	x1
Wi-Fi	802.11a/b/g/n/ac, 2.4 + 5 GHz
Wi-Fi screen mirroring	yes

Power source

Power consumption	operating: 28.42 W
.....	standby: 0.98 W
Input: AC 100-240 V, 50-60 Hz, 1.0 A (Max)	

Multimedia player

Supported video formats: MP4, RMVB, AVI, RM, MKV

Supported audio formats: MP3, WMA, OGG, FLAC, WAV

Supported photo formats: BMP, PNG, JPEG

Dimensions and weight

Unpacked (W x D x H)	68 x 74 x 142 mm
Packed (L x W x H)	195 x 110 x 133 mm
Net weight	0.309 kg / 0.68 lb
Gross weight	0.842 kg / 1.86 lb

Temperature requirements

Operating temperature	5 °C - 35 °C
Storage temperature	< 60 °C

Package contents

1. NeoPix 140 projector
2. Remote control
3. AC adapter
4. Power plug adapters (AUS, EU, UK, US)
5. AAA batteries for remote control
6. Quick Start Guide with Warranty Card

Model

NPX140/INT
EAN (INT): 7640186962964
UPC: 667619993163

CE statement

- The product shall only be connected to a USB interface of version USB 2.0 or higher.
- Adapter shall be installed near the equipment and shall be easily accessible.
- The operating temperature of the EUT can't exceed 35°C and shouldn't be lower than 5°C.
- The plug is considered as disconnect device of adapter.
- The UNII Band 5150-5250 MHz is for indoor use only.
- The device complies with RF specifications when the device is used at 20 cm from your body.

Hereby, Screeneo Innovation SA declares that this product is in compliance with essential requirements and other relevant provisions of Directive 2014/53/EU.



The Declaration of Compliance can be consulted on the site www.philips.com.

Frequency bands	Maximum output power
Wi-Fi 2.4GHz (EIRP)	17.88 dBm
Wi-Fi 5GHz (EIRP)	17.89 dBm

FCC statement

15.19 Labeling requirements.

This device complies with part 15 of the FCC Rules. Operation is subject to the following two conditions: (1) This device may not cause harmful interference, and (2) this device must accept any interference received, including interference that may cause undesired operation.

15.21 Information to the user.

Any changes or modifications not expressly approved by the party responsible for compliance could void the user's authority to operate the equipment.

15.105 Information to user.

This equipment has been tested and found to comply with the limits for a Class B digital device, pursuant to Part 15 of the FCC Rules. These limits are designed to provide reasonable protection against harmful interference in a residential installation. This equipment generates, uses and can radiate radio frequency energy and, if not installed and used in accordance with the instructions, may cause harmful interference to radio communications. However, there is no guarantee that interference will not occur in a particular installation. If this equipment does cause harmful interference to radio or television reception, which can be determined by turning the equipment off and on, the user is encouraged to try to correct the interference by one or more of the following measures:

- Reorient or relocate the receiving antenna.
- Increase the separation between the equipment and receiver.
- Connect the equipment into an outlet on a circuit different from that to which the receiver is connected.
- Consult the dealer or an experienced radio/TV technician for help.

During operation, the separation distance between the user and the antenna shall be at least 20 cm. This separation distance will ensure that there is sufficient distance from a properly installed externally-mounted antenna to satisfy the RF exposure requirements.

FCC ID: 2ASRT-NPX140

Canada regulatory compliance

This device complies with Industry Canada CAN ICES-3 (B)/NMB-3(B)

RSS-Gen & RSS-247 statement: This device complies with Industry Canada RSS standard(s).

Operation is subject to the following two conditions:

- 1 This device may not cause interference, and
- 2 This device must accept any interference, including interference that may cause undesired operation of the device.

RF Radiation Exposure statement: The device meets the exemption from the routine evaluation limits in section 2.5 of RSS102 and users can obtain Canadian information on RF exposure and compliance.

This device should be installed and operated with a minimum distance of 7.8 inches (20 centimetres) between the device and your body.

Other notice

Preservation of the environment as part of a sustainable development plan is an essential concern of Screeneo Innovation SA. The desire of Screeneo Innovation SA is to operate systems respecting the environment and consequently it has decided to integrate environmental performances in the life cycle of these products, from manufacturing to commissioning use and elimination.

Batteries: If your product contains batteries, they must be disposed of at an appropriate collection point.



Product: The crossed-out waste bin symbol on the product means that the product belongs to the family of electrical and electronic equipment. In this respect, the European regulations ask you to dispose of it selectively:

- At sales points in the event of the purchase of similar equipment.
- At the collection points made available to you locally (drop-off center, selective collection, etc.).

In this way you can participate in the reuse and upgrading of Electrical and Electronic Equipment Waste, which can have an effect on the environment and human health.

The paper and cardboard packaging used can be disposed of as recyclable paper. Have the plastic wrapping recycled or dispose of it in the non-recyclable waste, depending on the requirements in your country.

Trademarks: The mentioned references in this manual are trademarks of the respective companies. The lack of the trademarks ® and ™ does not justify the assumption that these dedicated terminologies are free trademarks. Other product names used herein are for identification purposes only and may

be trademarks of their respective owners.

Screeneo Innovation SA disclaims any and all rights in those marks.

Neither Screeneo Innovation SA nor its affiliates shall be liable to the purchaser of this product or third parties for damages, losses, costs, or expenses incurred by the purchaser or third parties as a result of accident, misuse, or abuse of this product or unauthorised modifications, repairs, or alterations to this product, or failure to strictly comply with Screeneo Innovation SA operating and maintenance instructions.

Screeneo Innovation SA shall not be liable for any damages or problems arising from the use of any options or any consumable materials other than those designated as original Screeneo Innovation SA/PHILIPS products or Screeneo Innovation SA/PHILIPS approved products.

Screeneo Innovation SA shall not be held liable for any damage resulting from electromagnetic interference that occurs from the use of any interface cables other than those designated as Screeneo Innovation SA/PHILIPS products.

All rights reserved. No part of this publication may be reproduced, stored in a retrieval system or transmitted in any form or by any means, electronic, mechanical, photocopying, recording, or otherwise, without the prior written permission of Screeneo Innovation SA. The information contained herein is designed only for use with this product. Screeneo Innovation SA is not responsible for any use of this information as applied to other devices.

This user manual is a document that does not represent a contract.

Errors, printing errors and changes are reserved.

HDMI™
HIGH-DEFINITION MULTIMEDIA INTERFACE

The terms HDMI, HDMI High-Definition Multimedia Interface, HDMI Trade Dress and the HDMI Logos are trademarks or registered trademarks of HDMI Licensing Administrator, Inc.



Screeeno Innovation SA

Route de Lully 5c - 1131 Tolochenaz - Switzerland

Philips and the Philips Shield Emblem are registered trademarks of Koninklijke Philips N.V. and are used under license. Screeeno Innovation SA is the warrantor in relation to the product with which this booklet was packaged.