



S18 / S26 / S32
120' / 132' / 135'
S-SERIES SPRAYER
OWNER'S MANUAL





Table of Contents

Section	Page
Table of Contents	3
Warranty Registration	11
<i>Warranty Inspection Report</i>	<i>11</i>
Inspections	13
<i>Pre-Delivery</i>	<i>13</i>
<i>Delivery</i>	<i>14</i>
<i>After-Sale</i>	<i>15</i>
Owner Register	16
Foreword to the Owner	17
INTRODUCTION	19
<i>Machine Components</i>	<i>20</i>
<i>Fence Row Nozzles</i>	<i>21</i>
<i>Boom Blue Lights</i>	<i>21</i>
<i>Boom Auto-Leveling</i>	<i>21</i>
<i>Boom Auto-Height</i>	<i>21</i>
<i>Touchdown Wheels</i>	<i>22</i>
<i>Speed Sensors</i>	<i>22</i>
<i>Chemical Eductor</i>	<i>22</i>
<i>Ladder</i>	<i>23</i>
<i>Cameras</i>	<i>23</i>
SAFETY	24
<i>Safety Alert Symbols and Signal Words</i>	<i>24</i>
<i>General Safety</i>	<i>25</i>
Prepare for Emergencies	<i>25</i>
Wear Protective Clothing	<i>25</i>
Protect Against Noise	<i>25</i>
Practice Safe Maintenance	<i>25</i>
Support Raised Equipment	<i>26</i>
Avoid Heating Near Pressurized Fluid Lines	<i>26</i>
Avoid High-Pressure Fluids	<i>26</i>
Inspect Lift Circuit Hoses	<i>27</i>
Store Attachments Safely	<i>27</i>



Electrical.....	27
Service Tires Safely.....	27
Dispose of Waste Properly.....	28
Handle Agricultural Chemicals Safely.....	28
Reduce risk of exposure and injury:.....	28
Handle Chemical Products Safely.....	29
Operate Hydraulics Safely.....	29
Use Safety Lights and Devices.....	30
Keep Riders Off Machine.....	30
Observe Maximum Transport Speed.....	30
EC Compliance Notification.....	31
Use a Signal Person.....	31
Use a Safety Chain.....	31
Tow Loads Safely.....	31
Avoid Overhead Power Lines.....	32
Prepare for Transport.....	32
Transport Safely.....	33
Park Safely.....	33
<i>Chemical Safety</i>	34
Personal Protection.....	34
Dilution.....	34
Storage.....	35
<i>Replace Safety Signs</i>	36
Hitch.....	36
Wing.....	37
Main Frame.....	38
Wheel and Tracks.....	38
<i>Safety Features</i>	39
<i>Sign-Off Form</i>	40
SPECIFICATIONS	41
<i>Tractor Power, Size Recommendation</i>	41
<i>Hydraulic System Requirements</i>	41
<i>Machine Dimensions & Specifications</i>	42
PREPARING THE MACHINE	43
<i>Use the Tractor Operator’s Manual</i>	43
<i>Break-In</i>	43
<i>Pre-Operation Checklist</i>	44
AXLES, TIRES, and TRACKS	45
<i>Setting Axle Width</i>	45
Axle Width Chart – Tires.....	46
Axle Width Chart – Tracks.....	47
<i>Checking Tire Pressure</i>	48



<i>Checking Wheel Nuts</i>	49
<i>Track Use</i>	50
General Guidelines.....	50
Maximizing Track Life	50
Track System Break-In	51
<i>Track Wear & Trash Buildup</i>	52
<i>Undercarriage Inspection and Maintenance</i>	52
<i>Track Service</i>	53
Mid-Wheel, Wedges, Idler, and Mid-Roller Cap Screws.....	53
Check Track Alignment.....	54
Track Alignment Procedure	55
CONTROLS	56
<i>Spray Circuit Controller</i>	56
<i>Chemical Circuit Controls</i>	56
<i>Chemical Circuit Pressure Gauge</i>	56
<i>Agitation & Rinse Controller</i>	56
<i>Boom Function Control Box</i>	57
CONTROLLER INSTALLATION	58
<i>Spray Circuit Controller</i>	58
<i>Boom Function Control Box</i>	58
<i>Agitation & Rinse Control Box</i>	58
ATTACHING and DETACHING	59
<i>Attach the Machine Safely</i>	59
<i>Make Proper Hose Connections</i>	59
<i>Attach the Machine to the Tractor</i>	60
<i>Attach Safety Chain to Tractor</i>	61
<i>Attach Warning Light Plug</i>	61
<i>Connect Rate Controller or Nutrient Applicator System Wiring</i>	61
<i>SCV Identification Chart</i>	62
<i>Detach Machine from Tractor</i>	63
<i>Adjust Hitch Height</i>	63
TRANSPORTING	64
<i>Following Safe Transport Procedures</i>	64
<i>Preparing the Machine for Transport</i>	64
Fold Implement for Transport	64
Automatic Folding	65



Manual Folding	65
Transport Notes and Checks	65
<i>Transporting the Machine</i>	66
Using Warning Lights	66
Keep Riders Off the Machine	66
<i>Caution for All Machines</i>	66
<i>Preparing the Machine for Field Use</i>	67
Unfolding/Extending the Boom	67
Automatic Unfolding	67
Manual Unfolding	67
HYDRAULIC FLOW	68
<i>Regulating Hydraulic Flow to the Pump</i>	68
Load Sensing Closed Center System (LS Closed)	68
Pressure Compensating Closed-Center System (PC Closed)	68
Open Center System (Open)	69
<i>Tractor SCV Functions</i>	70
<i>Steerable Hitch Adjustment</i>	70
SPRAYER CALIBRATION	71
<i>Set Engine RPM</i>	71
<i>Controller Calibration</i>	71
<i>Nozzle Calibration</i>	72
<i>Machine Yard Calibration</i>	72
<i>Ground Speed Calibration</i>	72
Area Coverage	73
<i>Field Calibration</i>	73
<i>Steerable Hitch Calibration</i>	76
ADJUST GROUND SPEED	77
<i>For broadcast spraying</i>	77
<i>For row crop spraying</i>	77
PREPARING THE LIQUID SYSTEM	78
<i>Agitation & Rinse</i>	78
<i>Clean Strainer Filter</i>	78
FILLING THE TANK	79
<i>Filling the Product Tank</i>	79
<i>Filling Fresh Water Rinse Tank</i>	79
<i>Use Tank Fill Marker</i>	80



CHEMICAL EDUCTOR.....	81
<i>Before Operation.....</i>	<i>81</i>
<i>Rinsing the Hopper.....</i>	<i>81</i>
<i>Start-Up.....</i>	<i>82</i>
<i>Pouring Chemical into the Hopper.....</i>	<i>82</i>
<i>Shutdown.....</i>	<i>83</i>
<i>Maintenance.....</i>	<i>84</i>
General Cleaning.....	84
Daily Maintenance.....	84
Yearly Maintenance.....	84
FIELD OPERATION.....	85
<i>Operation Procedure.....</i>	<i>86</i>
Boom Tilt.....	87
Boom Breakaway.....	87
<i>Pump & Pressure.....</i>	<i>87</i>
LUBRICATION & MAINTENANCE.....	88
<i>Lubricating and Maintaining the Machine Safely.....</i>	<i>88</i>
<i>Lubricant Storage.....</i>	<i>88</i>
<i>Grease.....</i>	<i>88</i>
Greases for Air Temperature Ranges.....	88
Alternative and Synthetic Lubricants.....	88
<i>Lubrication and Maintenance Intervals.....</i>	<i>89</i>
Grease Bank.....	89
Each 10 hours or Daily.....	89
Each 50 Hours or Weekly.....	90
Before and After Each Season.....	91
As Required.....	91
<i>Cleaning.....</i>	<i>92</i>
Filters.....	92
Main Tank.....	93
SERVICE.....	94
<i>Practice Safe Maintenance.....</i>	<i>94</i>
<i>Work in a Clean Area.....</i>	<i>94</i>
<i>Service Machines Safely.....</i>	<i>94</i>
<i>Support the Machine Properly.....</i>	<i>95</i>
<i>Avoid High-Pressure Fluids.....</i>	<i>95</i>
<i>Preventing Hydraulic System Contamination.....</i>	<i>95</i>
<i>Replace Hydraulic Hoses.....</i>	<i>96</i>



<i>Tightening Hardware</i>	96
<i>Breakaway Tension</i>	96
<i>Aligning Booms</i>	97
PREPARING FOR STORAGE	98
<i>Removing from Storage</i>	98
TROUBLESHOOTING	99
TIGHTENING HARDWARE	101
<i>Metric Bolt and Screw Torque Values</i>	101
<i>Unified Inch Bolt and Screw Torque Values</i>	102
<i>Face Seal Fittings Assembly & Installation - All Pressure Applications</i>	103
Face Seal O-Ring to Stud End Installation	103
Face Seal Adjustable Stud End O-Ring Installation.....	103
Face Seal Straight Stud End O-Ring Installation	103
Fitting Installation	103
Assembly Torque	103
<i>SAE Face Seal and O-Ring Stud End Fitting Torque Chart</i>	104





Limited Warranty

Fast Ag Solutions warrants to the buyer that the new machinery is free from defects in material and workmanship.

This warranty is only effective as to any new machinery which has not been altered, changed, repaired or treated since its delivery to the buyer, other than by Fast Ag Solutions or its authorized dealers or employees, and does not apply to accessories, attachments, tools or parts, sold or operated with the new machinery, if they have not been manufactured by Fast Ag Solutions.

Fast Ag Solutions shall only be liable for defects in the materials or workmanship attributable to faulty material or bad workmanship that can be proved by the buyer, and specifically excludes liability for repairs arising as a result of normal wear and tear of the new machinery or in any other manner whatsoever, and without limiting the generality of the foregoing, excludes application or installation of parts not completed in accordance with this Operator's Manual, specifications, or printed instructions.

Written notice shall be given by registered mail, to the Manufacturer within seven (7) days after the defect shall have become apparent or the repairs shall have become necessary, addressed as follows:

Fast Ag Solutions
4130 Commerce Boulevard
Windom, MN 56101

This warranty shall expire one (1) year after the date of delivery of the new machinery.

If these conditions are fulfilled, Fast Ag Solutions shall at its own cost and at its own option either repair or replace any defective parts provided that the buyer shall be responsible for all expenses incurred as a result of repairs, labor, parts, transportation or any other work, unless Fast Ag Solutions has authorized such expenses in advance.

The warranty shall not extend to any repairs, changes, alterations, or replacements made to the new equipment other than by Fast Ag Solutions or its authorized dealers or employees.

This warranty extends only to the original owner of the new equipment.

Rubber parts (including tires, hoses, grommets) are not warranted.

This warranty is limited to the terms stated herein and is in lieu of any other warranties whether express or implied, and without limiting the generality of the foregoing, excluding all warranties, express or implied or conditions whether statutory or otherwise as to quality and fitness for any purpose of the new equipment. The Manufacturer disclaims all liability for incidental or consequential damages.

This S-Series Sprayer is subject to design changes and Fast Ag Solutions shall not be required to retrofit or exchange items on previously sold units except at its own option.

Warranty void if not registered.



FAST S-SERIES SPRAYER

Warranty Registration

This form must be filled out by the dealer and signed by both the dealer and the customer at the time of delivery.

Customer Name					
Address					
City		State		Zip	
Phone					

Dealer Name					
Address					
City		State		Zip	

Sprayer Model					
Serial Number					
Delivery Date					

Warranty Inspection Report

DEALER INSPECTION REPORT

- All Fasteners Tight
- Wheel Bolts Torqued
- Hydraulic Hoses and Fittings Free and Tight
- Fertilizer Hoses and Fittings Free and Tight
- Wheel Drive Turns Freely
- Lubricate Machine
- Check Tire Pressure
- Frame and Wings Level
- Monitors and Controllers Function
- Wiring Harness Connected

SAFETY

- Safety Chain Installed
- All Guards Installed
- All Safety Signs Installed
- Reflectors, SMV, and Lights Clean
- Review Operating and
- Safety Instructions

I have thoroughly instructed the buyer on the above-described equipment which review included the Operator's Manual content, equipment care, adjustments, safe operation, and applicable warranty policy.

Date _____

Dealer's Rep. Signature _____

The above equipment and Operator's Manual have been received by me, and I have been thoroughly instructed as to care, adjustments, safe operation, and applicable warranty policy.

Date _____

Owner's Signature _____

White - FAST
Yellow - Dealer
Pink - Customer



FAST S18 / S26 / S32 Series Sprayer

SPRAYER SERIAL NUMBER _____

DATE PURCHASED _____ / _____ / _____

TANK SIZE (CIRCLE ONE) **1800 Gal. / 2600 Gal.** **3200 Gal.**

BOOM TYPE (CIRCLE ONE) **TRUSS** **CAMERA-READY**

BOOM WIDTH (CIRCLE ONE) **120 ft.** **132 ft.** **135 ft.**

NOZZLE SPACING (CIRCLE ONE) **15 in.** **20 in.** **22 in.**

PUMP MANUFACTURER:

(CIRCLE ONE)

ACE 255F-304 WET SEAL

ACE 255F-304 PWM WET SEAL

ACE FMC-750-HYD OASIS

ACE FMC-750 OASIS PWM



Inspections

Pre-Delivery

After the machine has been completely assembled, inspect it to be sure it is in good running order before delivering it to the customer. Ensure each item is found satisfactory or proper adjustment to the item(s) is made.

The following checklist is a reminder of points to inspect. It is neither an exclusive nor an exhaustive list of points to inspect. See the [Warranty Inspection Report](#) for a formal list.

- **SMV** emblem is installed, protective **shipping tape** is removed from reflectors, and **lights** are installed.
- All **grease fittings** are lubricated (see [LUBRICATION and MAINTENANCE](#) section in this Manual.)
- Inspect to be sure all **nuts** are tightened to proper torque and all **cotter pins** are spread.
- The **tires** are properly inflated (see [SPECIFICATIONS](#)).
- **Wheel bolts** are tightened to their specified torque(s).
- Fertilizer **row units** are properly adjusted.
- Warning **lights** are properly installed and operational.
- All customer-ordered **attachments** are installed or are available for delivery.
- Any parts scratched in shipment are touched up with **paint**.
- All **shipping decals** are removed.
- **Transport pins** are inserted in the transport holes.

This machine has been thoroughly checked and to the best of my knowledge is ready for delivery to the customer.

Signed: _____

Date: _____



Delivery

The following checklist is a reminder of information which should be conveyed directly to the customer at the time the machine is delivered.

Check off each item as it is fully relayed to the customer.

- Tell the customer to use proper tools.
- Explain to the customer that the life expectancy of this or any other machine depends on regular lubrication as directed in Operator's Manual.
- Make the customer aware of all safety precautions that must be followed while using this machine.
- When the machine is transported on a road or highway at night or during the day, accessory lights and devices should be used for adequate warning to Operators of other vehicles. For this matter, tell the customer to check local governmental regulations.
- Give the Operator's Manual to the customer and explain all operating adjustments.

To the best of my knowledge, this machine has been delivered ready for field use, and the customer has been fully informed as to its proper care and operation.

Signed: _____

Date: _____



After-Sale

The following is a suggested list of items to be checked at a dealer-customer mutually agreeable time during the first operating season.

- Check with the customer as to performance of machine. Make certain proper operating adjustments are understood.
- If possible, operate the machine to see that it is functioning properly.
- Acquaint the customer with any special attachment which will help do a better job.
- Go over the entire machine for loose or missing hardware.
- Check for broken or damaged parts.
- Ask the customer if recommended periodic lubrication has been performed.
- Review the Operator's Manual with the customer and stress the importance of proper lubrication and safety precautions.

Signed: _____

Date: _____



Owner Register

Model Number	Serial Number
---------------------	----------------------

Name		
Address		
County	State	Date Purchased

Name		
Address		
County	State	Date Purchased

Name		
Address		
County	State	Date Purchased

Name		
Address		
County	State	Date Purchased



Foreword to the Owner



Congratulations on your choice of an S-Series Sprayer to complement your agricultural operation!

READ THIS MANUAL carefully to learn how to operate and service your machine correctly. Failure to do so could result in personal injury or equipment damage. This Manual and safety signs on your machine may also be available in other languages.

THIS MANUAL SHOULD BE CONSIDERED a permanent part of your machine and should remain with the machine when you sell it.

MEASUREMENTS in this Manual are given in both metric and customary U.S. unit equivalents. Use only correct replacement parts and fasteners. Metric and inch fasteners may require a specific metric or inch wrench.

RIGHT-HAND AND LEFT-HAND sides are determined by facing in direction that the implement will travel when going forward.

WRITE SERIAL NUMBER of the machine in the [Specification](#) section and in the [Owner Register](#). Accurately record all numbers to help in tracing your machine should it be stolen. Your dealer also needs these numbers when you order parts. File identification numbers in a safe place off-machine.

BEFORE DELIVERING THIS MACHINE, your dealer performed a pre-delivery inspection.

THIS S-SERIES SPRAYER IS DESIGNED SOLELY for use in customary agricultural or similar operations for the purpose of applying chemical to row crops (“Intended Use”). Use in any other way is considered as contrary to the Intended Use. The manufacturer accepts no liability for damage or injury resulting from this misuse, and these risks must be borne solely by the user. Compliance with and strict adherence to the conditions of operation, service, and repair as specified by the manufacturer also constitute essential elements for the Intended Use.



THIS S-SERIES SPRAYER SHOULD BE OPERATED, serviced, and repaired only by persons familiar with all its particular characteristics and acquainted with the relevant safety rules (Accident Prevention). The Accident Prevention regulations, all other generally recognized regulations on safety and occupational medicine and the road traffic regulations must be observed at all times.

Any arbitrary modifications carried out on this S-Series Sprayer will relieve the manufacturer of all liability for any resulting damage or injury.

THIS DOCUMENT outlines the specific design and performance requirements for the use of a Fast Ag Solutions S-Series Sprayer assembly. The word “must” in this document indicates a mandatory requirement. The use of “should” indicates a recommendation of that which is advised but not required.

WARRANTY is provided as part of Fast Ag Solutions' support program for customers who operate and maintain their equipment as described in this Manual. The warranty is explained on the warranty certificate which you should have received from your dealer.

This warranty provides you with assurance that Fast Ag Solutions will back its products where defects appear within the warranty period. In some circumstances, Fast Ag Solutions also provides field improvements, often without charge to the customer, even if the product is out of warranty. Should equipment be abused or modified to change its performance beyond original factory specifications, the warranty will become void and field improvements may be denied.

TIRE MANUFACTURER'S warranty applicable to your machine may not apply outside U.S.

If you are not the original owner of this machine, it is in your interest to contact your local Fast Ag Solutions dealer to inform them of this unit's serial number. This will help Fast Ag Solutions notify you of any issues or product improvements.

INTRODUCTION



Read this Manual carefully before operating your FAST equipment. The information presented will prepare you to safely operate and service your machine.

All Operators are required to read this Manual carefully and be acquainted with all the operating and adjustment procedures before attempting to operate. Failure to follow the information in this Manual and on decals may result in personal injury or equipment damage.

This Manual should be considered a permanent part of this equipment and should remain with the equipment when you sell it. Replacement manuals can be obtained from your Fast Ag Solutions dealer.

This equipment has been engineered and manufactured to provide dependable and satisfactory use. Like all mechanical products, it will require cleaning and upkeep. Inspect your equipment before putting it into service. Your authorized Fast Ag Solutions dealer has trained mechanics, genuine FAST service parts, and the necessary tools and equipment when service is needed. Use only genuine FAST parts for service or repairs. Substitute parts will void the warranty and may not meet standards for safe and satisfactory operation.

Warranty is provided as part of Fast Ag Solutions' support program for customers who operate and maintain their equipment as described in this Manual. The warranty is explained on the warranty certificate you should have received from your dealer. This warranty provides you with the assurance that Fast Ag Solutions will back its products where defects appear within the warranty period. Should the equipment be abused or modified to change its performance beyond the original factory specifications, the warranty will become void.

These instructions have been compiled from field experience and engineering data. Some information may be general in nature due to unknown and varying operating conditions. However, through experience and these instructions, you should be able to develop procedures suitable to your particular situation.

.....

The illustrations and data used in this Manual were current at the time of printing. However, due to possible in-line production changes, your machine may vary slightly in detail. We reserve the right to redesign and change the machines as necessary without notification.

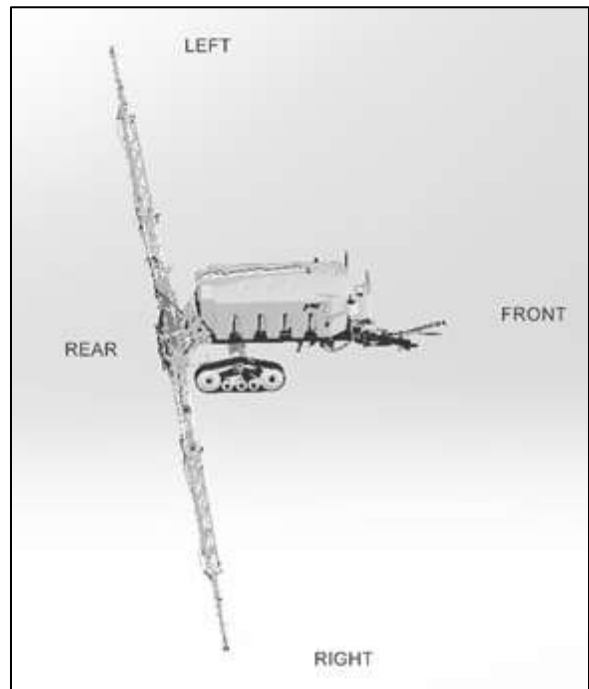

Figure 1: Orientation is viewed from behind the machine

Machine Components

This S-Series Sprayer is meant to distribute chemicals over a wide area. The system is pressurized by a hydraulic pump that provides flow for tank agitation, tank rinsing, and chemical dispersion.

A rinse tank is mounted on the side of the frame. An optional foam marker is available with its own separate tank.

A solenoid to each boom controls the flow to the wings, and a butterfly valve and flow sensor maintain the system pressure. Nozzles along the wings distribute the chemical solution over the field. A screen in the line next to the pump and after the solenoids removes contaminants from the system. The chemical system controller is mounted in the tractor cab for easy operation.

The booms attach to and are suspended from the back of the frame. The inner booms (B) swing rearward at right angles to the frame for field operation. The outer booms (C) pivot up and out for field operation. The wing breakaways (D) swing back if they hit an obstruction.

The boom position controller mounts in the cab for easy operation.

- A. Main Tank
- B. Rinse Tank
- C. Hand Wash Tank
- D. Inner Boom
- E. Outer Boom
- F. Breakaway Boom
- G. Boom Section Valves
- H. Boom Controller
- I. Chemical Controller (optional)

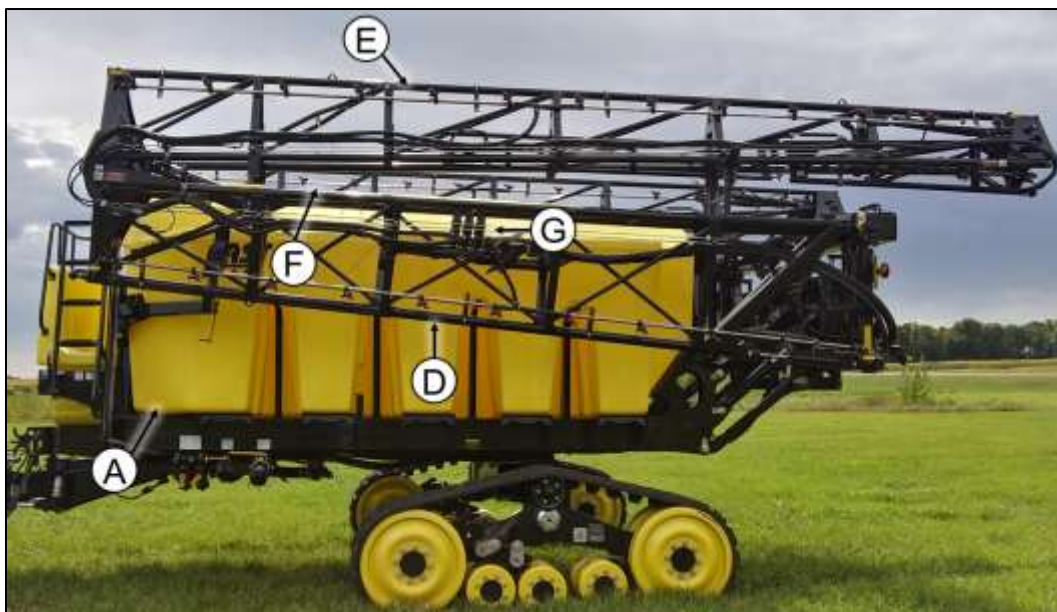

Fence Row Nozzles

Fence Row Nozzles are equipped to provide coverage next to a fence or at the edge of a field. Open the inline valve when spraying next to a fence and turn it off when in the field.



Figure 2: Standard manual fence row nozzle



Figure 3: Electric shutoff fence row nozzle

Boom Blue Lights

Blue lights are added to enhance the visibility of nozzle spray in low-light conditions. They are activated whenever the boom pivots out into field position.



Figure 4: Blue light on truss boom

Boom Auto-Leveling

An Auto Leveling System (optional) is mounted on the back of the frame. It is integrated into the hydraulic system to keep the booms level.



Boom Auto-Height

The Sprayer can be equipped with an "Auto Height" control system. The control valve is mounted on the back of the frame and connects into the hydraulic system to keep the booms at a preset height.



Touchdown Wheels

An optional touchdown wheel kit (A) is meant as a failsafe against changing boom height and headlands. **It is not intended to set the height of the boom.**



Speed Sensors

Sprayers that are equipped with an automatic controller must have a way to measure ground speed. A magnetic sensor is mounted on the right-hand wheel. Be sure the magnet clearance is set and maintained.

The ground speed proximity magnetic sensor system is located on the right wheel. It consists of a magnetic sensor and associated wiring. To generate the required signal, the magnet must be set and maintained at the proper distance from the pegs.

Set the magnet at 1/8 inch (3 mm) or the thickness of an American nickel from the pegs. Use the adjusting nuts and threads on sensor to set the gap. Be sure to tighten fasteners carefully so as not to strip the threads on plastic sensor.



Figure 5: Sensor mounting

Refer to the Radar's setup and calibration instructions enclosed with the Radar/Sensor and Controller for more information.

Chemical Eductor

An optional eductor tank can be mounted on the side of the frame. The tank is locked in the up position for operation and unlocked or lowered when adding chemical. Use the valves into and out of the tank to draw the chemical into the main circuit and to wash out the tank.

See [CHEMICAL EDUCTOR](#) for more details.

Ladder

The front frame is designed with a platform and an access ladder. The ladder can be raised or lowered as required for filling the rinse tank or operating in the field.

Raise the ladder into the vertical position and push over center to secure it in the locked position. The hydraulic dampener holds the ladder in the up (stowed) position. Position the ladder in the up position whenever the implement will be moved.



Figure 6: Ladder in the up position

Cameras

Select booms are equipped with self-contained vision systems capable of identifying weeds out in the field for precision agriculture applications. This system independently controls nozzle activation for immediate response.

To keep your vision system operating reliably, clean the lens and sensor window after each field use. Use compressed air or a soft brush to remove dust and debris, then wipe gently with lint-free cloth and a mild, camera-safe cleaner. Avoid harsh solvents or abrasive materials which can scratch protective coatings.

Regularly inspect all electrical connections, mounts, and wiring for signs of wear, corrosion, or looseness. Update the on-board firmware as recommended by the manufacturer to benefit from performance improvements and new detection algorithms.

When storing the unit off-season, keep it in a dry, temperature-controlled environment and protect it from prolonged exposure to direct sunlight or extreme temperatures.



Figure 7: Carbon Bee Striker X Sensor

SAFETY

The most important safety device on this equipment is a safe Operator. It is the Operator's responsibility to read and understand and follow all safety and operating instructions in this Manual.

As the Operator, you are responsible for the safe operation and maintenance of this equipment. You must ensure that you and anyone else who is going to operate, maintain or work around the machine is familiar with the operating and maintenance procedures and related safety information contained in this Manual.

You are the key to safety. Good safety practices protect you and the people around you. Be certain that everyone operating this equipment is familiar with the recommended operating and maintenance procedures and follows all safety precautions. Do not risk injury or death by ignoring good safety practices.

Safety Alert Symbols and Signal Words

This is a Safety Alert Symbol. When you see this symbol on your machine or in this Manual, be alert to the potential for personal injury.

Follow recommended precautions and safe operating practices.

Understand Signal Words

Throughout this Manual, the terms *CAUTION*, *WARNING*, and *DANGER* are used along with the Safety Alert Symbol to indicate the degree of personal safety hazard. The term *IMPORTANT* is used to indicate that failure to observe the hazard can cause damage to the equipment.

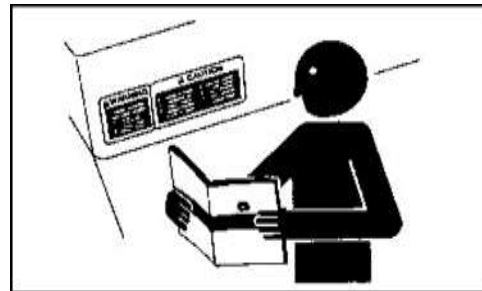

DANGER identifies the most serious hazards. DANGER or WARNING safety signs are located near specific hazards. General precautions are listed on CAUTION safety signs. CAUTION also calls attention to safety messages in this Manual.

Follow Safety Instructions

Carefully read all safety messages in this Manual and on your machine's safety signs. Keep safety signs in good condition.

Replace missing or damaged safety signs. Be sure new equipment components and repair parts include the current safety signs. Replacement safety signs are available from your Fast Ag Solutions dealer. There can be additional safety information contained on parts and components sourced from suppliers that is not reproduced in this Operator's Manual.

Learn how to operate the machine and how to use controls properly. Do not let anyone operate without instruction.

Keep your machine in proper working condition. Unauthorized modifications to the machine may impair the function and/or safety and affect machine life.

If you do not understand any part of this Manual and need assistance, contact your Fast Ag Solutions dealer.

General Safety

Prepare for Emergencies

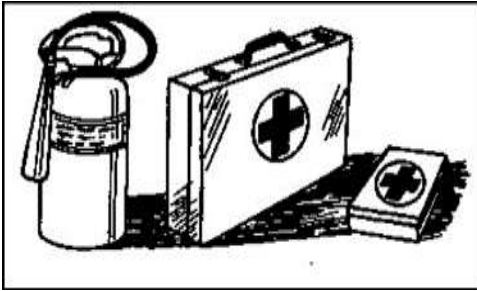

Be prepared if a fire starts.

Keep a first aid kit and fire extinguisher handy.

Keep emergency numbers for the poison control center, doctors, ambulance service, hospital, and fire department near your telephone.

In case of poisoning, get immediate medical attention.

Wear Protective Clothing

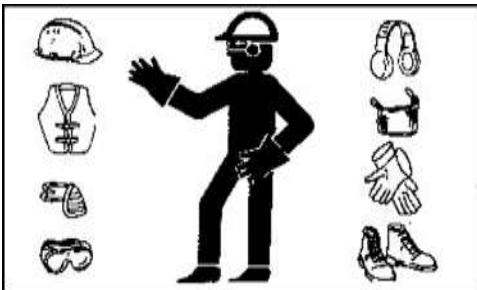

Wear close-fitting clothing and safety equipment appropriate to the job.

Operating equipment safely requires the full attention of the Operator. Do not wear radio or music headphones while operating the machine.

Keep hands, feet, hair, and clothing away from all moving and/or rotating parts.

Protect Against Noise



Prolonged exposure to loud noise can cause impairment or loss of hearing.

Wear a suitable hearing protective device such as earmuffs or earplugs to protect against objectionable or uncomfortable loud noises.

Practice Safe Maintenance



Understand service procedures before doing work. Keep the area clean and dry.

Never lubricate, service, or adjust the machine while it is moving. Keep hands, feet, and clothing away from power-driven parts. Disengage all power and operate controls to relieve pressure. Lower equipment to the ground. Stop the engine. Remove the key. Allow machine to cool. Securely support any

machine elements that must be raised for service work.

Keep all parts in good condition and properly installed. Fix any damage immediately. Replace worn or broken parts. Remove any buildup of grease, oil, or debris.

On self-propelled equipment, disconnect the battery ground cable (-) before making any adjustments on electrical systems or welding on the machine.

On towed implements, disconnect wiring harnesses from tractor before servicing electrical system components or welding on the machine.

Support Raised Equipment



Always use a safety support when working on, under, or around the machine. Transport/Service locks can be used for this purpose.

Shut off the tractor's engine and remove the key when working on the machine.

If air has been allowed to enter hydraulic hoses or cylinders, bleed the hydraulic system before use. If there is a failure in the hydraulic system, unsupported or raised equipment could suddenly lower, causing serious personal injury or death.

If support is not available, completely lower wings and frame, relieve hydraulic pressure and disconnect hoses from tractor.

Avoid Heating Near Pressurized Fluid Lines



Flammable spray can be generated by heating near pressurized fluid lines, resulting in severe burns to yourself and bystanders. Do not heat by welding, soldering, or using a torch near pressurized fluid lines or other flammable materials. Pressurized lines can accidentally burst when heat goes beyond the immediate flame area.

Avoid High-Pressure Fluids



Inspect hydraulic hoses periodically – at least once per year – for leakage, kinking, cuts, cracks, abrasion, blisters, corrosion, exposed wire braid, or any other signs of wear or damage.

Replace worn or damaged hose assemblies immediately with Fast Ag Solutions approved replacement parts.

Escaping fluid under pressure can penetrate the skin causing serious injury.

Avoid the hazard by relieving pressure before disconnecting hydraulic or other lines. Tighten all connections before applying pressure.

Search for leaks with a piece of cardboard. Protect hands and body from high-pressure fluids.

If an accident occurs, see a doctor immediately. Any fluid injected into the skin must be surgically removed within a few hours or gangrene may result. Doctors unfamiliar with this type of injury should reference a knowledgeable medical source.

Inspect Lift Circuit Hoses



Avoid serious injury or death while working under a raised implement. Hydraulic hoses between the lift cylinders and hydraulic lock-up valves should be inspected frequently for leakage, kinking, cuts, cracks, abrasion, blisters, corrosion, exposed wire braid, or any other signs of wear or damage. Worn or damaged hose assemblies can fail during use and should be replaced immediately. See your Fast Ag Solutions dealer for replacement hoses.

Store Attachments Safely



Stored attachments such as dual wheels can fall and cause serious injury or death. Securely store attachments and implements

to prevent falling. Keep playing children and bystanders away from storage area.

Electrical



Check all electrical wiring and connections for damage. Keep the battery terminals clean and tight. Repair or replace any damaged part or wires that are loose or frayed.

Service Tires Safely

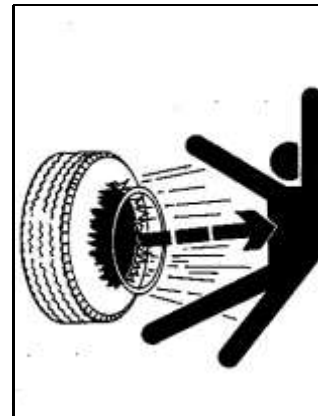

CAUTION: Explosive separation of a tire and rim parts can cause serious injury or death.

Do not attempt to mount a tire unless you have the proper equipment and experience to perform the job.

Never weld or heat a wheel and tire assembly. The heat can cause an increase in air pressure resulting in a tire explosion. Welding can structurally weaken or deform the wheel.

Always maintain the correct tire pressure. Do not inflate the tires above the recommended pressure. Never weld or heat a wheel and tire assembly. The heat can cause an increase in air pressure resulting in a tire explosion.

Welding can structurally weaken or deform the wheel.

When inflating tires, use a clip-on chuck and extension hose long enough to allow you to stand to one side and NOT in front of or over the tire assembly. Use a safety cage if available.

Check wheels for low pressure, cuts, bubbles, damaged rims, or missing lug bolts and nuts. Replace as necessary.

Dispose of Waste Properly

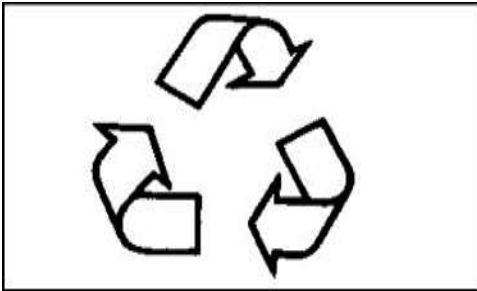

Improperly disposing of waste can threaten the environment and ecosystem. Potentially harmful waste used with equipment includes such items as oil, fuel, coolant, brake fluid, filters, and batteries.

Use leakproof containers when draining fluids. Do not use food or beverage containers that may mislead someone into drinking from them.

Do not pour waste onto the ground, down a drain, or into any water source.

Air conditioning refrigerants escaping into the air can damage the Earth's atmosphere. Government regulations may require a certified air conditioning service center to recover and recycle used air conditioning refrigerants.

Handle Agricultural Chemicals Safely

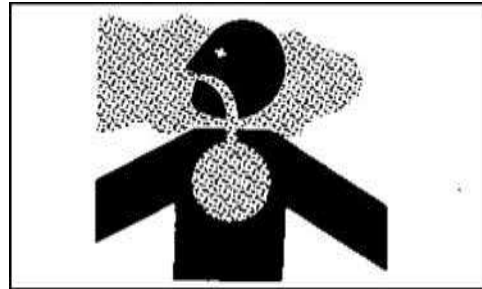

Chemicals used in agricultural applications such as fungicides, herbicides, insecticides, pesticides, rodenticides, and fertilizers can be harmful to your health or the environment if not used carefully.

Always follow all label directions for effective, safe, and legal use of agricultural chemicals.

Reduce risk of exposure and injury:

Wear appropriate personal protective equipment as recommended by the manufacturer. In the absence of manufacturer's instructions, follow these general guidelines:

Chemicals labeled 'Danger' (Most toxic) generally require use of goggles, respirator, gloves, and skin protection.

Chemicals labeled 'Warning' (Less toxic) generally require use of goggles, gloves, and skin protection.

Chemicals labeled 'Caution' (Least toxic) generally require the use of gloves and skin protection.

Avoid inhaling vapor, aerosol, or dust.

Always have soap, water, and a towel available when working with chemicals. If a chemical contacts skin, hands, or face, wash

immediately with soap and water. If chemical gets into eyes, flush immediately with water.

Wash hands and face after using chemicals and before eating, drinking, smoking, or urination.

Do not smoke or eat while applying chemicals.

After handling chemicals, always bathe or shower and change clothes. Wash clothing before wearing it again.

Seek medical attention immediately if illness occurs during or shortly after use of chemicals.

Keep chemicals in original containers. Do not transfer chemicals to unmarked containers or to containers used for food or drink.

Store chemicals in a secure, locked area away from human or livestock food. Keep children away.

Always dispose of containers properly. Triple rinse empty containers and puncture or crush containers and dispose of properly.

Handle Chemical Products Safely

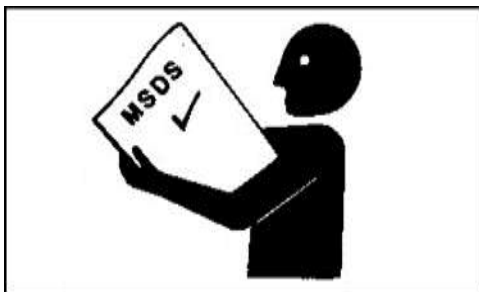

Direct exposure to hazardous chemicals can cause serious injury. Potentially hazardous chemicals used with FAST equipment include such items as lubricants, coolants, paints, and adhesives.

A Material Safety Data Sheet (M/SDS) provides specific details on chemical products: physical and health hazards, safety procedures, and emergency response techniques.

Check the M/SDS before you start any job using a hazardous chemical. That way you will know exactly what the risks are and how to do the job safely. Then follow the procedures with the recommended equipment.

Operate Hydraulics Safely



Before operating, make sure air has been bled from wing-fold hydraulic system.

Be sure the area around the machine is clear before raising or lowering the machine's frame or wings.

Do not operate with wings folded.

Do not operate close to the edge of a ditch, creek, gully, or steep embankment. Avoid holes, ditches, and obstructions which may cause the tractor, machine, or towed equipment to roll over, especially on hillsides.

Avoid sharp turns on hillsides.

Slow down when turning, traveling over rough ground, or when turning on inclines.

Always shut off tractor and shift to PARK or set brakes when leaving tractor. Remove key when leaving tractor unattended.

Always have the tractor stop on level ground when raising or lowering wings. Operate the machine from tractor seat only. If chemicals are used, follow the manufacturer's recommendations for handling and storage.

Tow the machine behind a properly equipped tractor only.

Use Safety Lights and Devices

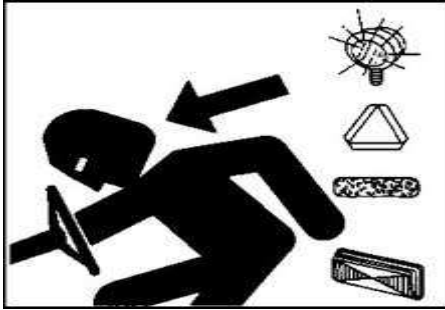

Prevent collisions between other road users, slow moving tractors with attachments or towed equipment, and self-propelled machines on public roads. Frequently check for traffic from the rear, especially in turns, and use turn signal lights.

Use headlights, flashing warning lights, and turn signals during both day and night. Follow local regulations for equipment lighting and marking. Keep lighting and marking visible, clean, and in good working order. Replace or repair lighting and marking that has been damaged or lost.

Keep Riders Off Machine

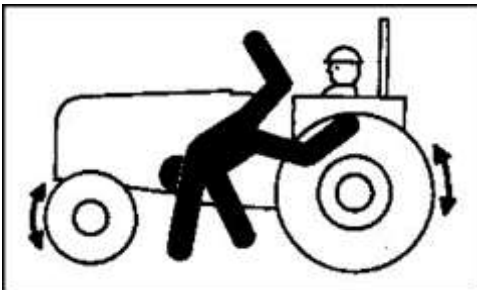

Only allow the Operator on the machine. Keep riders off.

Riders on the machine are subject to injury such as being struck by foreign objects and being thrown off of the machine. Riders also obstruct the Operator's view resulting in the machine being operated in an unsafe manner.

Observe Maximum Transport Speed

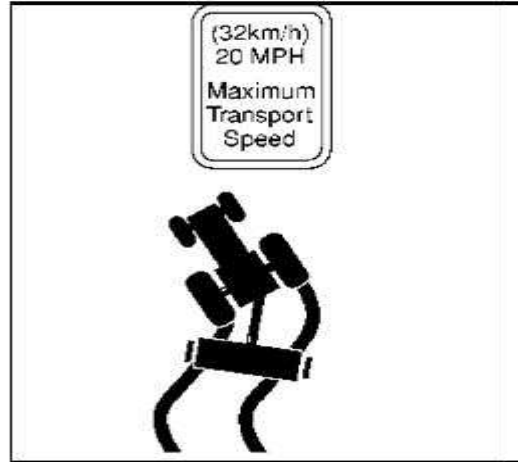

⚠ CAUTION: Be sure all bystanders are clear of Sprayer.

⚠ IMPORTANT: Transport Sprayer only with tank EMPTY to prevent Sprayer damage.

This implement is not equipped with service or parking brakes. The maximum transport speed for this implement is 20 MPH (32 KPH) when the ratio weight of the equipped implement to the weight of the towing machine is 1:1 or less. If that ratio is between 1:1 and 2:1, the maximum transport speed is 10 MPH (16 KPH). When that ratio exceeds 2:1, towing is not allowed.

Some tractors are capable of operating at speeds that exceed the maximum transport speed of this implement. Regardless of the maximum speed capability of the tractor being used to tow this implement, do not exceed the implement's maximum transport speed.

Exceeding the implement's maximum transport speed can result in:

- Loss of control of the tractor/implement combination.
- Reduced or no ability to stop during braking.
- Implement tire failure.
- Damage to the implement structure or its components.

Use additional caution and reduce speed when towing under adverse surface conditions, when turning, and when on inclines. For transport, the weight of the EMPTY Sprayer must not be more than 1.5 times the weight of the tractor. The minimum towing tractor weight for the S-Series Sprayer is 10300 lbs.

Never tow this implement with a motor vehicle. Tow only with a properly ballasted tractor.

a safe distance away from the machine when it is moving.

Prior to starting the tractor, discuss hand signals and what each signal means to avoid misunderstandings and confusion which could result in a serious injury or fatal accident for someone.

Keep all bystanders away whenever the machine is moved.

EC Compliance Notification



▲ WARNING: Environmental transportation hazard. A loaded machine driven on public roads has a high risk of tire failure. Do not use the machine for transporting product(s) on public roads.

Never transport with a tank filled with water or chemical(s).

Use a Safety Chain

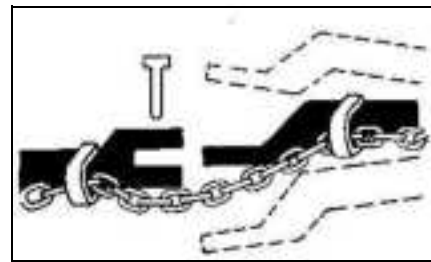

A safety chain will help control drawn equipment should it accidentally separate from the drawbar.

Using the appropriate adapter parts, attach the chain to the tractor drawbar support or other specified anchor location. Provide only enough slack in the chain to permit turning.

Use a Signal Person

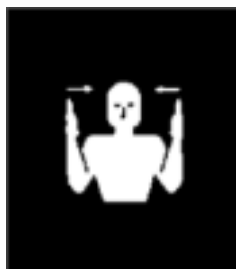

Use a signal person to direct movement of the tractor / implement combination, whenever the tractor operator's view is obstructed.

Designate one individual as THE signal person. Always have the signal person stand in clear view. Be sure the signal person stays

Tow Loads Safely



Stopping distance increases with speed and weight of towed loads and on slopes. Towed loads with or without brakes that are too heavy for the tractor or are towed too fast can cause loss of control. Consider the total weight of the equipment and its load.

Observe these recommended maximum road speeds or local speed limits which may be lower:

If towed equipment does not have brakes, do not travel more than 32 km/h (20 mph) and do not tow loads more than 1.5 times the tractor weight.

Ensure the load does not exceed the recommended weight ratio. Add ballast to the recommended maximum for the tractor, lighten the load, or get a heavier towing unit. The tractor must be heavy and powerful enough with adequate braking power for the towed load. Use additional caution when towing loads under adverse surface conditions, when turning, and on inclines.

Avoid Overhead Power Lines



▲ WARNING: Keep away from overhead power lines. Serious injury or death may result.

Proceed cautiously under overhead power lines and around utility poles. Know the transport height of your machine. Electrocutation can occur without direct contact with overhead electrical lines.

Prepare for Transport

▲ CAUTION: Avoid serious injury or death to your or others.

Never tow the machine behind a truck or other motor vehicle. This machine is designed only to be towed with a properly sized and ballasted tractor.

Use a tractor large enough to maintain control. Properly ballast tractor for towing your machine. Refer to tractor Operator's Manual and this Manual to ensure that machine can be safely transported with your tractor.

Be aware of height and width restrictions to avoid a collision with overpasses or other road users.

Always fold wings fully. If wing fold cylinders are removed, chain wings together to prevent accidental lowering. Fully raise frame, close hydraulic lock-up valve (if equipped) and install Transport/Service locks before transporting. Latch the tractor brakes together.

Attach a properly sized safety chain for the load being towed. Refer to [Use a Safety Chain](#).

▲ IMPORTANT: Do not transport on a roadway unless the machine is equipped with proper functioning lights and reflective markings or emblems.

Ensure that the lights and reflective markings or emblems are clean and visible. Contact your Fast Ag Solutions dealer for lights and lighting harnesses.

Always follow local and national regulations for equipment size, lighting and marking before driving on public roadways. You are responsible for understanding and complying with all requirements regarding roadway transport. Refer to [Use Safety Lights and Devices](#).

Transport Safely



⚠ CAUTION: When transporting, always travel at a reasonable and safe speed which permits adequate control of steering and stopping.

Reduce speed considerably when traveling over rough ground. Be certain everyone is clear of the machine.

Do not exceed weight and speed guidelines. Refer to [Observe Maximum Transport Speed](#).

Towed loads can swerve and upset or cause loss of control. Refer to [Tow Loads Safely](#). Shift tractor into a lower gear when transporting down steep slopes or hills; never coast. Stop slowly.

Wide turns may be required with the machine in tow. Use caution in traffic and in congested areas.

To improve stability when traveling through the field, wings should be unfolded from transport position as soon as possible after leaving the roadway.

▲ IMPORTANT: When transporting the machine on a roadway, **ALWAYS USE** appropriate lamps and devices for adequate warning to operators of other vehicles.

Refer to [Use Safety Lights and Devices](#).

Park Safely



Parked Jack Position

A - Pin

Park the machine on a level surface, lower the jack, and retain it with pin (A). Block implement wheels.

Chemical Safety

Personal Protection

To reduce or eliminate contact with chemicals, it is necessary to wear adequate protective clothing, respirators, boots, goggles, and gloves.

Respirators - Protection against inhalation (but no skin contact) is provided quite economically when using face mask respirators. Choose a mask that will fit your face and check with the manufacturer about the details of filters and chemical cartridges used in the respirator model. Note that full- and half-face masks cannot be worn securely by those with beards, whiskers, sideburns, and moustaches. Instructions on the operational life and performance of filters and cartridges generally accompany the products. However, when carrying out operations, it is wise to change the filters each day, and the cartridges should be replaced when chemical odor is noticed. Wash the face mask with warm water and soap before installing a new cartridge and filter. Do not store cartridges and filters in the chemical storage area as they can absorb the chemical even when not in use.

Goggles - When a full mask is not worn, the use of protective goggles is necessary and is recommended to protect the eyes from pesticide vapor, solids, and accidental splashes particularly. Safety supply companies offer a range of goggles. Many goggles are resistant to chemicals, some have specially treated lenses to reduce fogging, and others have anti-fogging ventilation. Prescription-type glasses are also available to which side shields can be attached.

Gloves - Non-absorbent gloves should be worn at all times when handling, mixing, and applying pesticides. Neoprene has been found to be superior to rubber in resisting the penetration of pesticides. Other factors to be considered in selecting suitable gloves include sense of touch, wet grip, and cut and

abrasion resistance. Gloves should not have fabric wristbands or lining and should fit properly. Always wash the glove inside and out after use. Leather gloves are not suitable.

Footwear - Non-absorbent footwear should be worn when applying pesticides. It is suggested that the most suitable boot is one that is knee length, acid and solvent resistant, and ribbed to prevent slippage. Neoprene is considered superior to rubber. Leather boots are not suitable.

Clothing - For general protection, coveralls should be worn along with gloves and a hat to minimize the hazard of the skin absorbing pesticides. Clothing should be changed and washed regularly following spraying. You can now purchase disposable clothing that provides protection against exposure resulting from pesticide drift, splashing, or spills. These garments (overalls, shirts and pants, head cover, and aprons) are light weight and cooler than rubber articles. Protective equipment and clothing are available from safety supply companies. Never use leather garments (e.g., jackets, gloves, or shoes) during the handling or application of pesticides. Leather can absorb chemicals, and it is very difficult to decontaminate leather articles.

Dilution

Pest control is dependent upon the application of minute amounts of a toxic substance. This process starts with the proper mixing of the toxic material with water. It is very important that the operator reads the mixing and dilution instructions on the chemical container before starting. Combine the chemical and water in the proportions recommended on the container only. Improper mixing can damage the crops or not affect the pests.

Storage

Only use the quantity of chemical product(s) required for the job.

Store chemicals only in their original containers under lock and key to prevent children or animals from touching them.

Be very careful to wear the proper protective gear such as rubber gloves and goggles to protect yourself. Thoroughly wash all protective gear with a good detergent after use to remove all chemicals.

Never allow chemicals or solutions to touch the skin. Some can be absorbed through the skin. Should such a contact occur, flush the affected area immediately with clear water. Wash the area thoroughly with detergent to remove any residue.

When work is done, the machine should always be rinsed. Follow this procedure:

1. Add 25 to 50 gallons of water to the main tank after the chemical solution has been spent or drained.

⚠ CAUTION: Do not exceed 50 PSI of pump pressure while rinsing. Damage to the rinse ball assemblies will occur.

2. Run the pump, wash circuit, and agitator for 5 minutes to circulate and rinse the inside of the tank.
3. Dispense the rinse thinly over the previously worked field.

When work is finished for the season or when switching chemicals, wash the Sprayer thoroughly.

See [PREPARING FOR STORAGE](#).

⚠ WARNING: Do not dispose of chemicals in the farmyard or in drainage ditches.

Replace Safety Signs

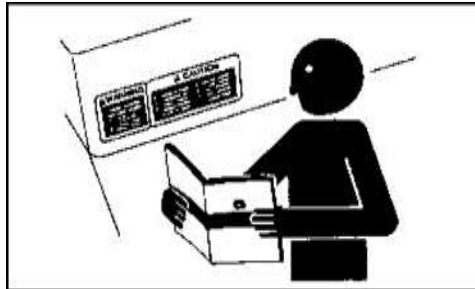

Replace missing or damaged safety signs. Use this Operator's Manual for correct safety sign placement.

There can be additional safety information contained on parts and components sourced from suppliers that is not reproduced in this Operator's Manual.

Hitch

A

DANGER

Avoid serious injury or death from runovers. Do not adjust while machine is in motion.

B

CAUTION

1. Keep all shields in place.
2. Disengage and shut off all engine and/or motor power before servicing or unloading machine.
3. Keep hands, feet and clothing away from powerdriven parts.
4. Do not leave running machine unattended.

C

WARNING

Be sure cylinder and attaching hoses are fully charged with oil before operating system. Failure to do so will allow wings to fall rapidly when attempting to lower from transport position.

D

CAUTION

Agricultural chemicals can be dangerous. Improper selection or use can injure persons, animals, plants, soils or other property.

TO AVOID INJURY

1. Select the right chemical for the job.
2. Handle and apply it with care. Follow instructions issued by the chemical manufacturer.

A



B





C



Wing





A



B

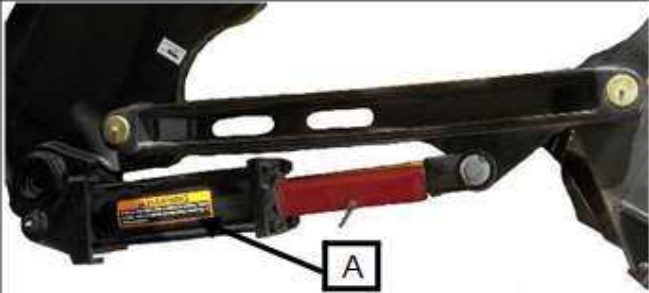

Main Frame



A

⚠ WARNING

Avoid serious injury from crushing or pinning. Install cylinder lockups before transporting, servicing, or storing machine.

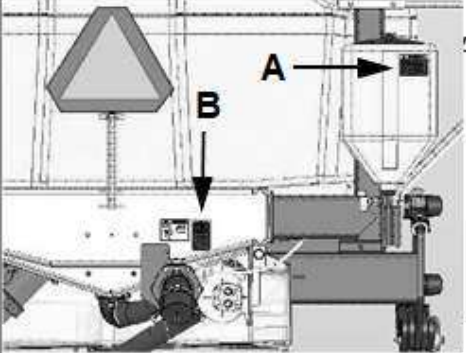

A

B

⚠ WARNING

Water for rinse/wash purpose only. Do not drink from this container. Container may become contaminated by sprayer chemicals. Fill with clean rinse water only.

⚠ CAUTION

Agricultural chemicals can be dangerous. Improper selection or use can injure persons, animals, plants, soils or other property.

TO AVOID INJURY

1. Select the right chemical for the job.
2. Handle and apply it with care. Follow instructions issued by the chemical manufacturer.

Wheel and Tracks



A

ATTENTION: PLEASE CHECK LUG NUT TORQUE AT 5, 10, AND 50 HOURS OF OPERATION, AND REGULARLY THEREAFTER. TORQUE SHOULD BE 265 FT/LBS.

⚠ CAUTION

HELP PREVENT FIRE

Trash build-up between tracks and chassis can cause fire from increased friction.

- Keep machine free of trash.
- Keep a fire extinguisher at hand.

Safety Features

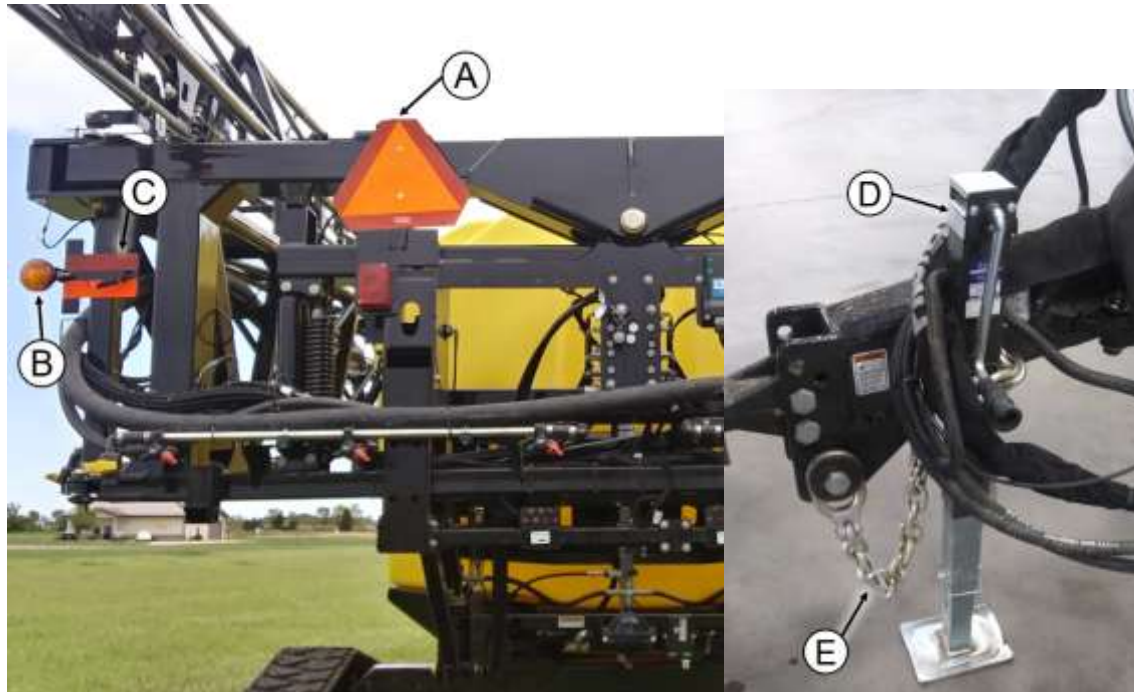

- A. SMV Emblem
 - i. Identifies slow-moving equipment and alerts traffic approaching from the rear.
- B. Warning Lights
 - i. Alert other drivers to the machine's presence and width of slow-moving machinery on roadways and signal turns.
- C. Reflectors
 - i. Alert other drivers to the machine's presence and width of slow-moving machinery on roadways.
- D. Jack
 - i. Prevents the machine from falling when in storage.
- E. Safety Chain
 - i. Will help control the machine should it accidentally separate from tractor drawbar.

In addition to the safety features shown here, other components, systems, safety signs on the machine, safety messages, and instructions in the Operator's Manual contribute to the safe operation of this machine when combined with the care and concern of a capable Operator.

The construction of this implement may not meet all local or national requirements for transport on a public roadway. In regions or countries that have national certification requirements for roadway transport, it may be impossible for this implement to be approved for such roadway transport. The customer is responsible for understanding and complying with all local, regional, and national requirements regarding roadway transport.



Sign-Off Form

Fast Ag Solutions follows the general Safety Standards specified by the American Society of Agricultural Engineers (ASAE) and the Occupational Safety and Health Administration (OSHA). Anyone who will be operating and/or maintaining the FAST S-Series Sprayer must read and clearly understand ALL Safety, Operating, and Maintenance information presented in this Manual.

Do not operate or allow anyone else to operate this equipment until such information has been reviewed. Annually review this information before season start-up.

A sign-off sheet is provided as a template for your records to show that all personnel who will be working with the equipment (Operators) have read and understand the information in this Manual and have been instructed in the safe operation, service, and maintenance of the equipment.

Date	Employee's Signature	Employer's Signature



SPECIFICATIONS

Tractor Power, Size Recommendation

Use the machine with a tractor providing drawbar power in the following ranges:

Tank Size, L (gal.)	Machine size, m (ft)	Tractor Power, kW (HP)	Min. Tractor Weight, kg (lbs.)
6814 (1800)	37 (120)	135-180 (180-240)	4630 (10200)
9842 (2600)	40 (132)	185-240 (250-320)	4710 (10400)
2113 (3200)	41 (135)	240-275 (320-370)	4870 (10700)

▲ IMPORTANT: Verify the main tank is empty before transporting on road.

Hydraulic System Requirements

A tractor hydraulic system with ISO hydraulic couplers is required.

Tractor Selective Control Valves (SCV) at the listed flowrates and pressure are required for following:

Circuit	SCV Function	Flowrate, LPM (GPM)	Pressure, MPa (psi)
1	Main Lift Cylinders	27.8 (7.3)	20.7 (3000)
1	Tilt Cylinders	29.3 (7.7)	20.7 (3000)
1	Primary Fold Cylinders	17.8 (4.7)	20.7 (3000)
1	Secondary Fold Cylinders	13.4 (3.5)	20.7 (3000)
1	Tertiary Fold Cylinders	12.9 (3.4)	20.7 (3000)
2	Chemical/Fertilizer Pump Drive Motor	60.6 (16)	20.7 (3000)
3	Steerable Hitch Block (if equipped)	26.7 (7.1)	20.7 (3000)



Machine Dimensions & Specifications

Model	1800 Gal. / 2600 Gal.	3200 Gal.
Transport Height	4 m (156 in)	3.9 m (154 in)
<i>Transport Height with Tires</i>	-	4.0 m (157 in)
Transport Width	3.8 m (150 in)	3.7 m (146 in)
Transport Overall Length	7.8 m (309 in)	8.7 m (344 in)
Transport Pin-to-Axle Length	5.1 m – 5.3m (199 in – 208 in)	
Weight, empty	6976 kg (15380 lb.)	7215 kg (15906 lb.)
Weight, full	20308 kg (44772 lb.)	20725 kg (45690 lb.)
Standard Tires	380/90R54	TTS 15"
Track 15" Outer Width	3.5m (139in)	3.4m (135in)
580/85R42 Outer Width	-	3.7 m (146 in)
710/70R42 Outer Width	-	3.8 m (151 in)
Tank size	6814 L (1800 Gal.) 9842 L (2600 Gal.)	12113L (3200 Gal.)
Quick-Fill Size	51 mm (2 in.)	76 mm (3 in.)
Tank Agitation	Trumpet Agitation	
Rinse Head count	2 (50 psi)	
Spray Height	0.5 m (20 in) - 1.8 m (72 in)	
Nozzles	Single, Triple, or Quintuple Bodies	
Section Count	6, 10, or 16	
Flow Type	Uni-Directional or Recirculating	
Standard Hydraulic Pump	ACE 255F Wet Seal	
Controller Power	12 VDC, 15 A	
Cab Fold Box	12 VDC, 10 A	
Cab Agitation & Rinse Box	12 VDC, 7.5 A	

See [Checking Tire Pressure](#) for tire information.

PREPARING THE MACHINE

Use the Tractor Operator's Manual

Always refer to tractor operator's manual for specific detailed information regarding operation of equipment.



Break-In

See [TIGHTENING HARDWARE](#) for all torque values.

After **1 hour** of operation:

1. Tighten all wheel lugs.
2. Tighten all other fasteners and hardware to their required torque.
3. Check that no chemical or hydraulic lines are being pinched or crimped. Re-route as required.
4. Check that all filters, nozzles, and fitting components are clean and working properly. Clean as required.
5. Lubricate all grease fittings.

After **5 hours** of operation:

1. Tighten all wheel lugs.

After **10 hours** of operation:

1. Tighten all fasteners and hardware to their required torque.
2. Check chemical and hydraulic line routings.
3. Check that all placement components are clean and working properly.

After **50 hours** of operation:

1. Tighten all wheel lugs.
2. Then follow the normal servicing and maintenance schedule in [LUBRICATION & MAINTENANCE](#).



Pre-Operation Checklist

Efficient and safe operation of the machine requires that each Operator reads and understands operating procedures and all related safety precautions outlined in this section. A pre-operational checklist is provided for the Operator. It is important for both personal safety and maintaining the good mechanical condition of the Sprayer that this checklist be followed.

Before operating the Sprayer, check the following items:

1. Lubricate machine per the schedule outlined in the [LUBRICATION and MAINTENANCE](#) section.
2. Use only a tractor of adequate power and weight to operate the Sprayer. See the [SPECIFICATIONS](#) section for recommendations.
3. Be sure that the machine is properly attached to the tractor. Be sure that a mechanical retainer is installed through the drawbar and that a pin and safety chain are installed.
4. Inspect all hydraulic lines, hoses, fittings, and couplers for tightness. See [Tightening Hardware](#) for break-in period recommendations.
5. **IMPORTANT:** Extend the axles out of the shipping width setting and set the track or tire width for your application. The unit is shipped with axles to the narrowest setting using the shipping holes for shipping purposes only. See [SETTING AXLE WIDTH](#).
6. Check tires and verify they are inflated to the specified pressure. See [Checking Tire Pressure](#)
7. Check track tension or [tire pressure](#) and hardware torque.
8. Calibrate the Sprayer if at the start of the season or a new application rate is being used.
9. Check the condition and routing of all fluid hoses and lines. Be sure that all lines are routed in large arcs. Replace any that are damaged. Re-route those that are rubbed, pinched, or crimped. See [Replace Hydraulic Hoses](#).
10. Check chemical application components. Remove and replace any that are worn.
11. Remove all entangled material.
12. Replace any plugged nozzles or tubes.

AXLES, TIRES, and TRACKS

Setting Axle Width

▲ **IMPORTANT:** Adjust axles out of the shipping width before transporting or application. Set axles to the widest setting possible to match row width. Use only the holes with measurements. See axle width charts.



1. Jack one side up on frame in front of axle and support the frame on the rear of the axle with jack stands (A). 10-ton jack stand shown.

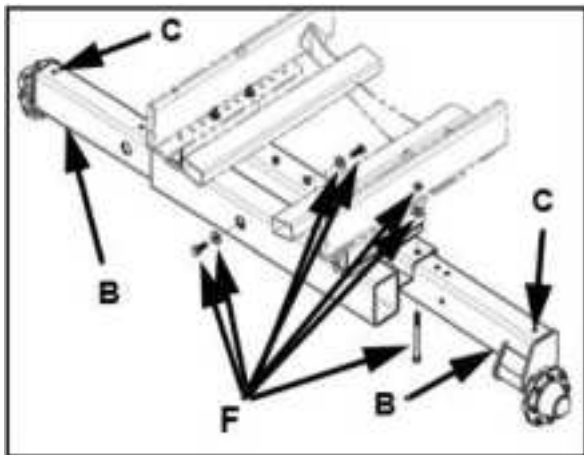

2. Remove the axle bolts (F) and slide the axles (B) out of shipping holes (C).

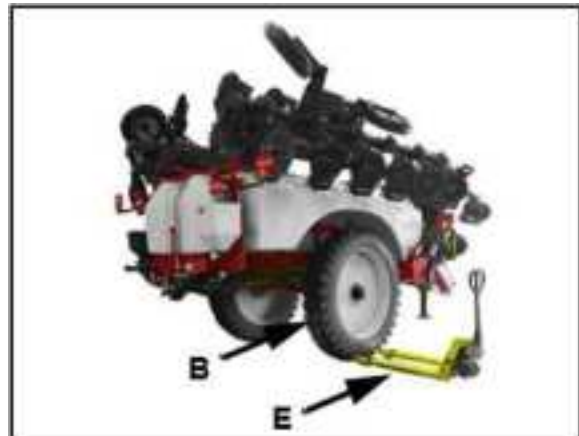
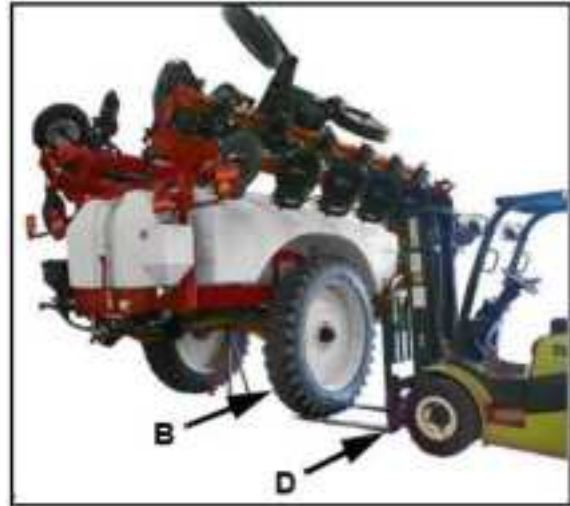

3. Using a forklift (D) or pallet jack (E), slide the wheel and axle tube (B) out to the holes matching row width (See axle width charts). Axles (B) must be moved out from shipping holes (C) to match crop spacing, to prevent crop damage, and for stability. Set both axles to the same width.
4. Reinstall the axle hardware with the threads facing up.
5. Torque the 5/8" bolts to 149 N-m (110 ft-lbs.) and the 3/4" bolts to 271 N-m (200 ft-lbs.).
6. Repeat for other side.

Axle Width Chart – Tires

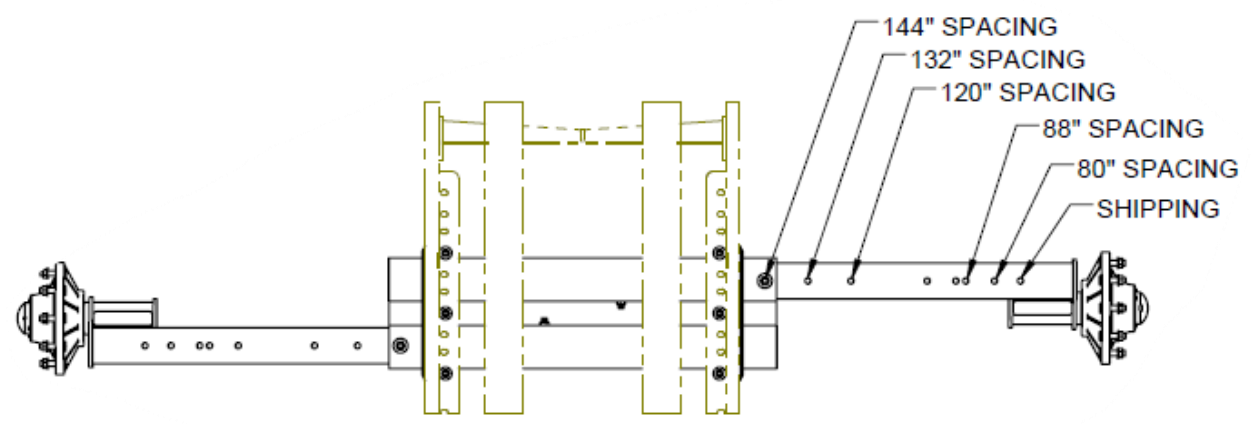

Figure 8: 20k (for 1800 Gal. / 2600 Gal.) 72"-144" axle

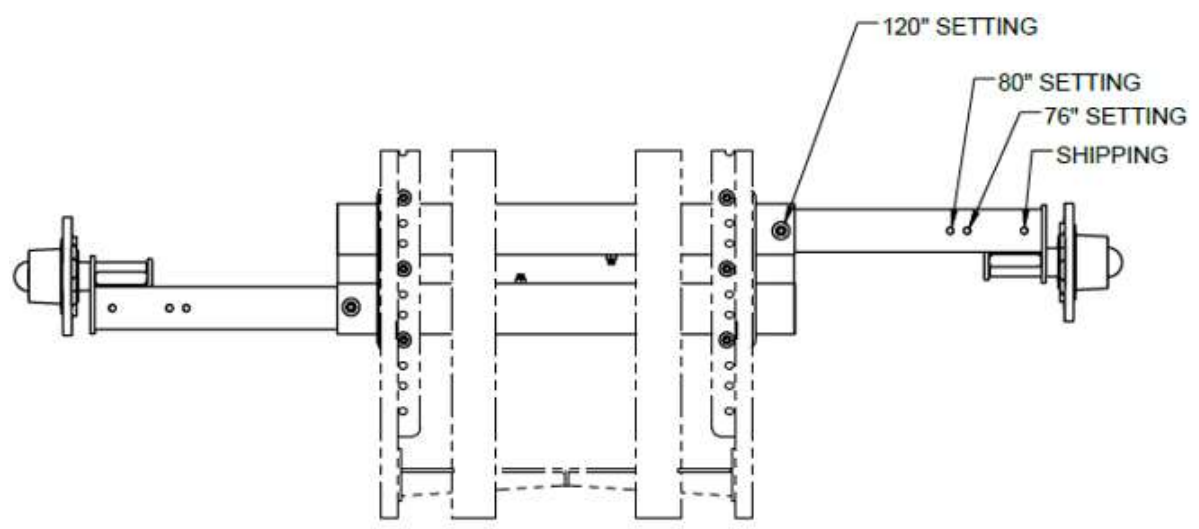
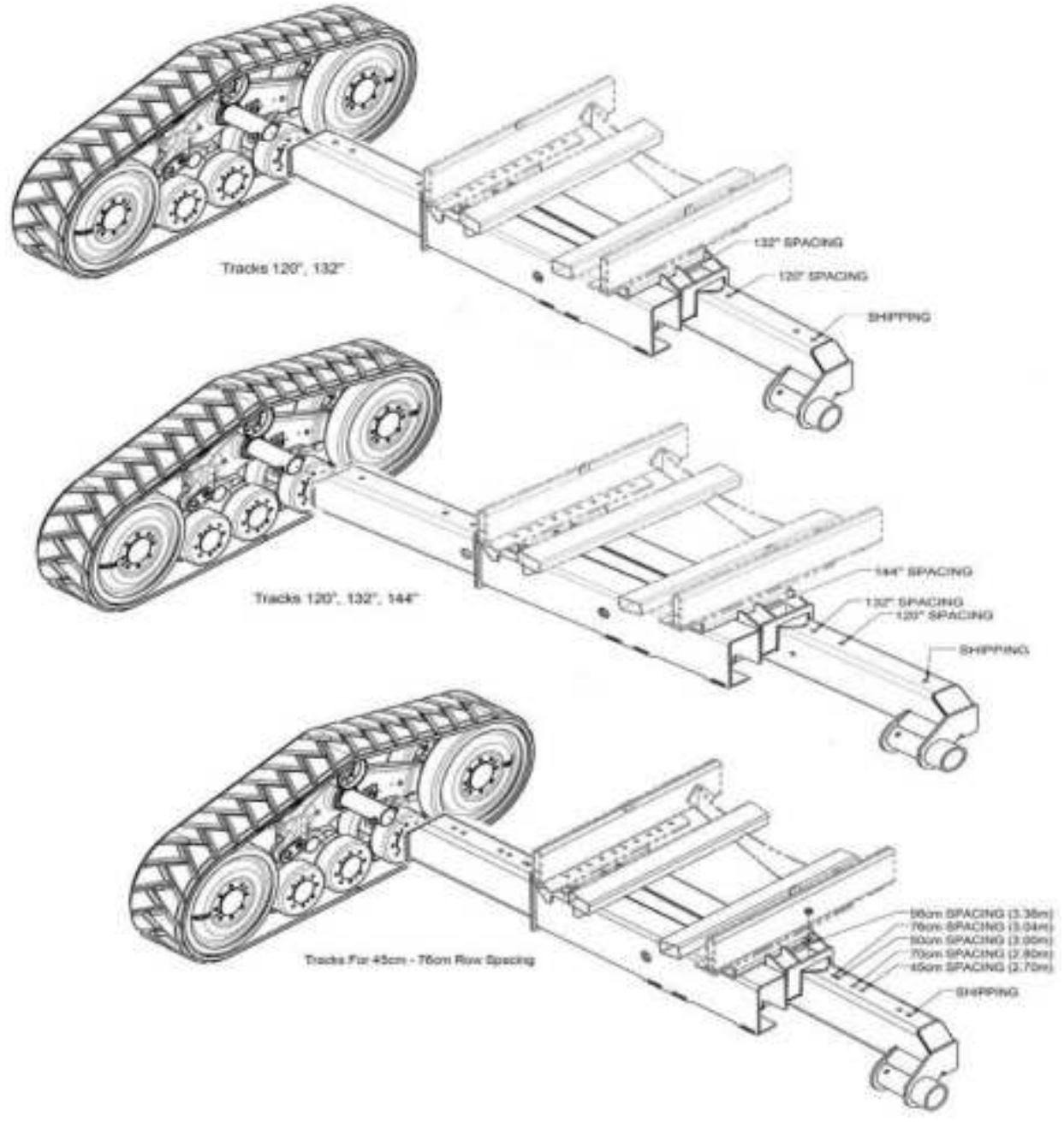

Figure 9: 15k (for 1800 Gal. / 2600 Gal.) 62"-120" axle



AXLES, TIRES, and TRACKS

Axle Width Chart – Tracks





Checking Tire Pressure

Check tire pressure and inflate as necessary.

⚠ CAUTION: Avoid loss of vehicle control during transport from failure of overloaded tires which could cause serious injury or death to you or others.

Equal pressure in all tires is necessary for even penetration. A low tire will cause deeper penetration on one side than the other. Increased penetration on one side will result in side-draft of the machine. Inflate tires to shown specification.

Tire Size	Pressure
380/90R46 LR168 (Singles)	538 kPa (8.38 bar) (78 PSI)
380/90R46 LR149 (Duals)	255 kPa (2.55 bar) (37 PSI) Inner 227 kPa (2.28 bar) (33 PSI) Outer
380/90R54 LR170 (Singles)	517 kPa (5.17 bar) (75 PSI)
380/90R54 LR152 (Duals)	255 kPa (2.55 bar) (37 PSI) Inner 227 kPa (2.28 bar) (33 PSI) Outer
480/80R50 LR176	545 kPa (5.45 bar) (73 PSI)
580/85R42 LR183	283 kPa (2.83 bar) (41 PSI)
710/70R42 LR193	359 kPa (3.59 bar) (52 PSI)

▲ NOTE: Tire pressure is directly linked to its Load Rating (LR###). Make sure of the load rating of the tire before adding any air to the tire.

Checking Wheel Nuts

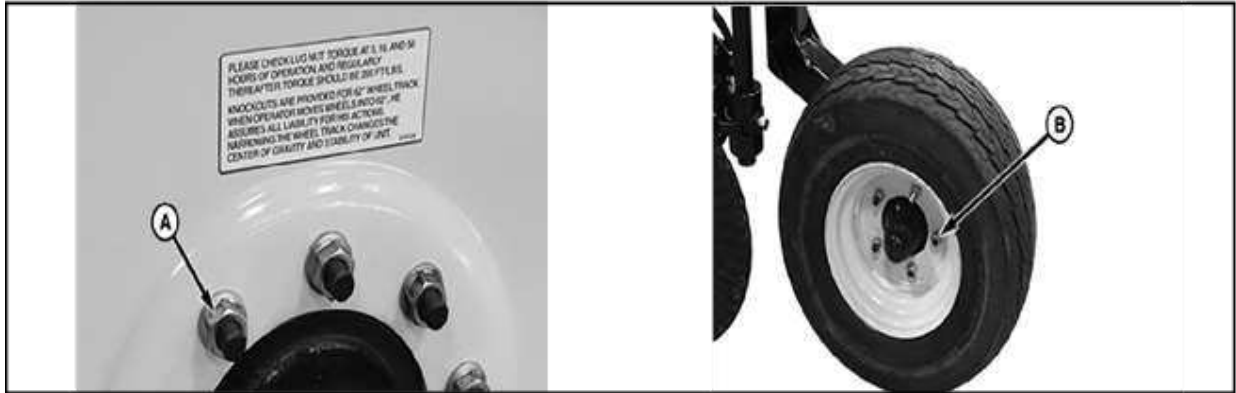

- A. Main Frame Wheel Nut
- B. Gauge Wheel Nut

Check tightness of all wheel nuts (A) and (B) during the first week of operation and periodically after that.

Tighten all wheel bolts to specification.

Item	Specification
(A) Main Frame Wheel Nut	359 N-m (265 ft-lbs.)
(B) Gauge Wheel Nut	95 N-m (70 ft-lbs.)



Track Use

General Guidelines

- Before trailering on-road for the first time, precondition tracks. See [Track Systems Break-In](#).
- Avoid traveling at high speeds with a new set of tracks and wheels, especially during the first 50-100 hours.
- Trash build-up can cause fire from increased friction. Remove trash from trash build-up points between track and trailer frame.
- Avoid operating tracks in grease, oil, or other petroleum chemicals. Avoid spilling these materials on tracks and wheels during service.

Maximizing Track Life

Track carcasses are designed to exceed tread wear out, but only so long as the integrity of the carcass is maintained. It is critical to keep moisture out of the steel carcass and to avoid situations where localized cable overloading could occur. Track machine owners are advised to follow these guidelines to achieve maximum track life and avoid operational problems, all of which result in lower cost per operating hour:

- Minimize roading. Excessive roading can increase track wear up to 15 times field wear rates.
 - Minimize transport weight during road transport.
 - Reduce maximum travel speed especially during high ambient conditions.
- Use correct operational techniques.
 - Avoid skidding and tread bar scrubbing on hard surfaces to reduce track wear.
 - Use care when crossing ditches or transitions while making turns. Diagonal crossing of ditches causes track to become unsupported in the center and the idler(s) to hit the opposite embankment. This can cause momentary loss of tension that can drop the center section down and outside the drive or idler wheels making derailing a much higher risk if in a turn.
 - Use a ratchet-turn or bump steer technique. When turning at the end of a field, steering performance can be gained by turning in several small turns, returning to neutral position between each ratchet steer. This helps gain more traction and complete the turn more efficiently and with less ground disturbance than by attempting to power and spin through turn.
- Maintain correct track tension.
 - Under-tension causes rapid wear on tracks and the inside surface of the belt due to slippage and may potentially cause material buildup.
 - Over-tension adds extra load and stress to undercarriage bearings, internal track cables, and the track frame.
- Keep irregular material out of tracks.
 - Sharp, hard material inside the track is the primary reason for localized track tears and subsequent entry points for moisture into the track carcass.



Track System Break-In

Break-In Overview

Avoid roading at high speeds with a new set of tracks or wheels, especially during the first 50-100 operating hours. Damage to drive lugs and wheels may result.

Track systems' break-in takes place during the first season of use. Correct break-in helps reduce amount of initial drive lug wear. During break-in, drive lugs and idlers undergo a “polishing in” process which:

- Scours out excess rubber flash inside the drive wheels.
- Embeds fine dust particles in rubber surfaces to remove tackiness of new rubber.

Surface polishing reduces frictional heating in the track system. During break-in, new rubber surfaces require contact with a dry lubricant such as soil. Avoid high speed operation (roading or higher speed tillage) where the track system is run in absence of dust generated by dry soil contact (wet conditions or paved roads). Operating in these conditions for lengthy periods may cause excessive early-hour drive lug wear.

Perform initial break-in and alignment before any high-speed tractor operation. Excessively clean frictional track components (belts, drive wheels, front idlers, and mid-rollers) can generate significant heat if run unlubricated. This heat is capable of damaging components. Break-in and align new components as outlined.

Initial Break-In

Avoid track and track system component damage. Before driving the tractor on-road for the first time, precondition tracks with loose soil or clay-based lubricant. Repeat application of lubricant or soil at least every 50 miles until destination is reached.

After installation of new or cleaned track belts or other frictional components, expose clean components to materials to lubricate and break them in.

- Work the Sprayer in-field in loose soil for at least 15 minutes.
- If the Sprayer cannot be exposed to loose soil, use a “clay-based” granular material (clay-based lubricant, kitty litter, oil-dry absorbent, or talc powder) to introduce a “joint” area between drive wheels and belts continuously for at least 15 minutes.

Track Belt Alignment

After the initial break-in procedure is completed, align the track. See [Check Track Alignment](#).

After Break-In

After the initial 100-hour break-in and alignment, a long-term break-in process (up to 400 hours) will likely occur. During this period, maximize the exposure of tracks to soft soil and minimize high speed, heavily loaded transport operation.

Track Wear & Trash Buildup

Avoid grease, oil, or other petroleum chemicals on tracks and wheels. Constant exposure to petroleum-based chemicals may damage rubber surfaces.

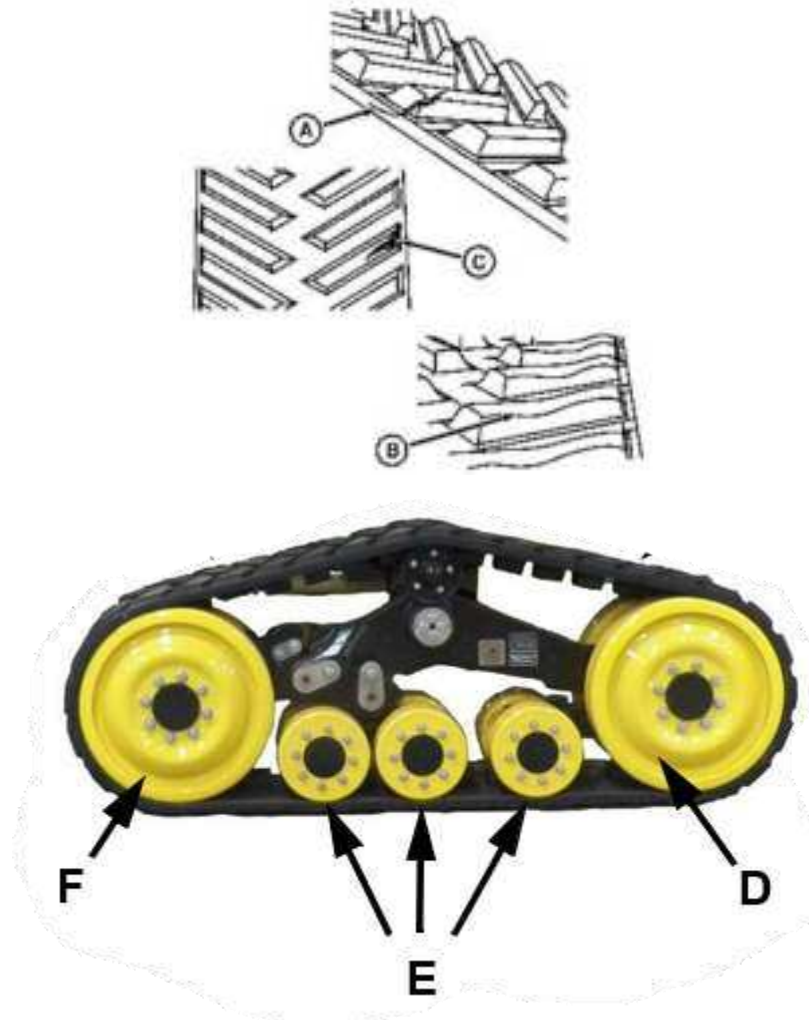

Trash build-up can cause fire from increased friction. Remove trash from trash build-up points (G) between track and applicator frame.

Inspect for cracking (A), uneven wear (B) and/or chipping or chunking (C) on rubber surfaces of drive wheels (D), mid-rollers (E) and idler wheels (F).

Remove any embedded rocks, nails, or other sharp object in track belt or mid-rollers.

Undercarriage Inspection and Maintenance

Perform required lubrication. (See [LUBRICATION](#) and [MAINTENANCE](#) section.)

Inspect for loose, damaged, or missing parts. Repair or replace parts before entering the field.

1. Remove any debris or material buildup on the tops of frame reaction arms. Buildup can wear down rubber on wheels.

2. Check for material buildup between mid-wheels and idler wheels. Buildup can damage or crush guide lugs and can increase chances of derailing the track. If guide lug tip damage is seen, it may be due to material buildup.
3. Look over mid rollers and idler wheels for visible cracks around the bolt pattern or the rim. If seen, contact your Fast Ag Solutions dealer for the best recommendation of repair or replacement.

Track Service

Service Task	Service Action
Track Wear	Check
Track Alignment	
Track Tension	
Idler Wheels and Mid-Rollers	
Track Trash Buildup	
Mid-Rollers Oil Level	
Idler Wheel Hub Oil Level	Tighten
Idler Wheel and Mid-Roller Cap Screws	

Mid-Wheel, Wedges, Idler, and Mid-Roller Cap Screws

If the Sprayer is operated with loose cap screws, they may become worn, and it may be necessary to replace them.

Re-tighten track cap screws after working 3 HOURS, 10 HOURS and DAILY during the first week of operation.

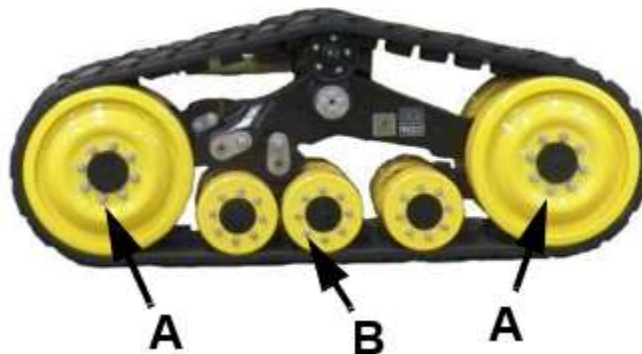

Inspect and re-torque idler wheel (A) and mid-roller (B).

Screws	Torque
M16 Idler Wheel Cap	320 N-m (236 ft-lbs.)
M20 Mid-Roller Wheel Cap	620 N-m (457 ft-lbs.)

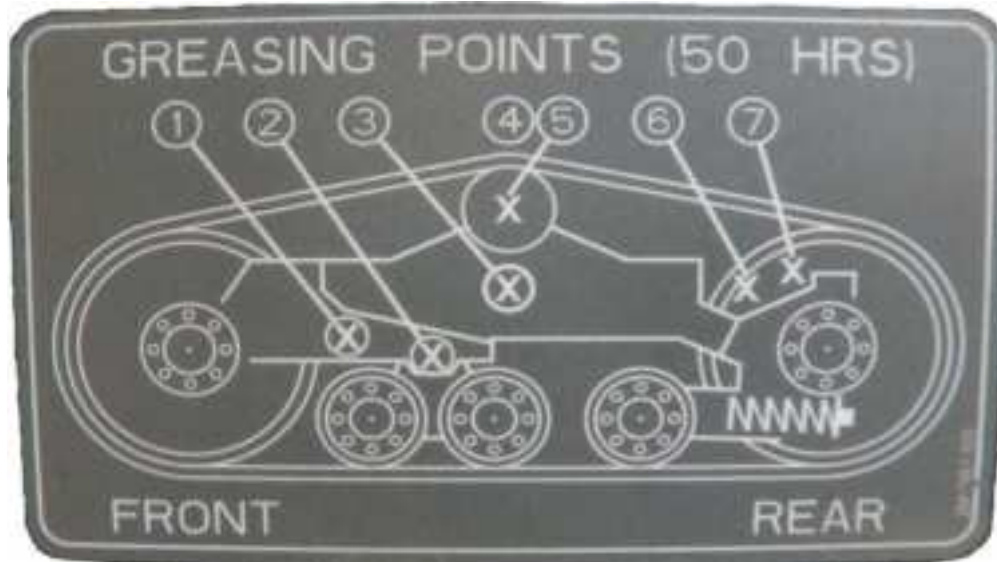

Check Track Alignment

1. Prior to checking track alignment, the implement should be empty and spring tensioning mechanism set properly with no pre-load.
2. Pull the implement on a flat surface for a suitable timeframe allowing the belts to relax and move freely on the undercarriage rollers.
3. Drive in a straight line for roughly 200 ft and coast the tractor to a stop. Place the tractor in PARK and apply the emergency brake. Do not apply braking action during this process as sudden stops can affect track position during the alignment process.
4. Using a $\frac{1}{4}$ " x 4" x 8" shim (A) slid between the front mid-roller and guide lugs (B). Bridge guide lugs with the shim maintaining pressure on a minimum of 2 lugs.

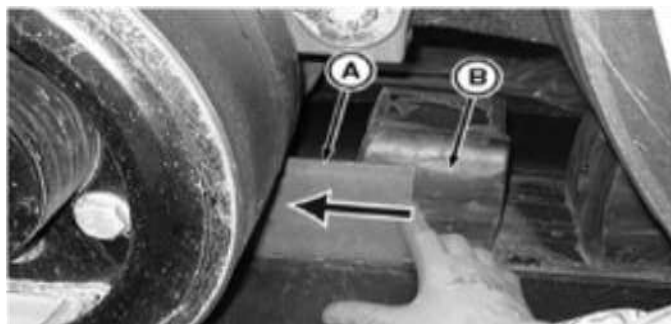

5. If the shim fits freely between the lugs and mid-roller on both sides of the undercarriage, the alignment is correct. If the shim binds and does not fit between the mid-rollers / guide lugs, track adjustment is necessary.

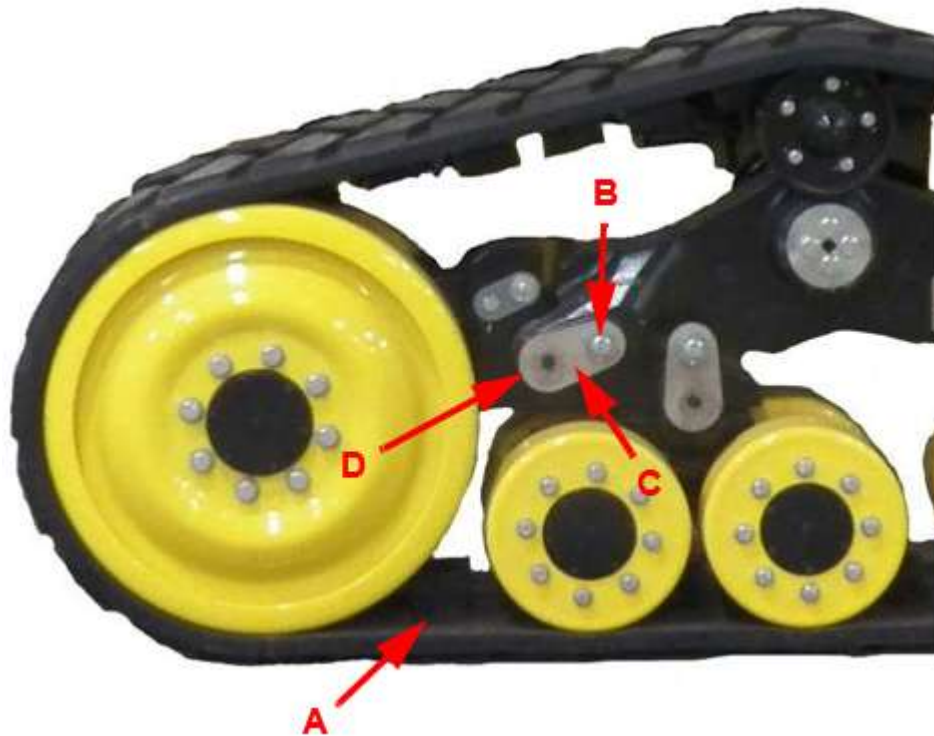

Track Alignment Procedure

1. Remove the alignment bolt retainer lock plate cap screws (B) and lock plate (C) from the inboard and outboard sides of the undercarriage needing adjustment.
2. Loosen cap screw (D) counterclockwise 1.0-1.5 turns on the side of the undercarriage you want the track to move towards (A represents location between inner idler wheel surface and guide lug).
3. Tighten the special cap screw on the opposite side of the same undercarriage to 300 N-m (221 ft-lbs.). Tighten cap screw loosened in Step 2 to the same specification.
 - a. A single full turn is the standard increment during adjustment. Lessen this amount as final adjustment is approached.
4. Re-check track alignment and adjust until suitable clearance is obtained on both sides of the guide lugs.
 - a. Lock plates are reversible for double the index increments.
 - b. If needed, increase torque on the special cap screw slightly allowing advancement to a suitable lock plate position.
5. When alignment is complete, reinstall the lock plates and tighten cap screws to their required torque specification of 130 N-m (95 ft-lbs.).

CONTROLS

Spray Circuit Controller

A microprocessor-based controller is available to set, monitor, adjust, and display several spray circuit parameters for the operator. Review and follow the [calibration procedure](#) at the start of the season and when changing chemicals or nozzles. Familiarize yourself with each controller function and control before starting.



Figure 10: Optional Spray Circuit Controller

Chemical Circuit Controls

The following components are installed in the liquid circuit.

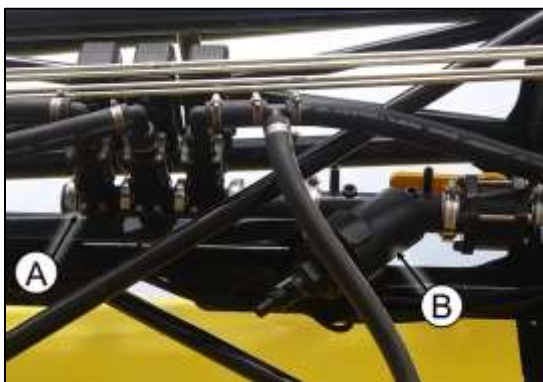

- A. Section (Boom) valves
- B. Valve Strainer

Chemical Circuit Pressure Gauge



The chemical circuit of each machine is equipped with a pressure gauge that is attached to the front rinse tank's support and visible to the operator. Use it to monitor the chemical circuit pressure.

See [Pump & Pressure](#) for more information.

Agitation & Rinse Controller



The Main Tank can be mixed (agitated) and rinsed. The two left rocker switches open and close their respective distribution valves on the trailer.

Control where the pump pulls fluid from with the third rocker switch. The use of this switch should be coordinated with the first two. Normally, use fluid from the Main Tank when agitating, and use fluid from the Rinse Tank when rinsing.

Boom Function Control Box



This control box is mounted in the cab and attached to a 12-volt power source. The wiring harness is routed across the hitch and plugs into the connector coming from the Sprayer. Be sure that there are no power lines next to the machine and that the machine is in an open area large enough to allow the booms to swing out without hitting any obstructions. The hydraulic circuit control lever to the boom function circuit must be placed in detent prior to operating.

- A. **Left Boom Tilt Position:** This spring-loaded-to-neutral-center toggle switch controls the left boom tilt function. Move the switch up and hold to raise the tip of the left boom and down to lower. Release the switch, the left boom will stop moving and remain in position. Use this function to raise the tip of the boom to clear obstructions.
 - B. **Boom Up/Down:** This spring-loaded-to-neutral-center toggle switch controls the boom height cylinder. Move the switch up and hold to raise the entire boom assembly. Move the switch down and hold to move it down. Release the switch, the boom will stop and remain at that position.
 - C. **Right Boom Tilt Position:** This spring-loaded-to-neutral-center toggle switch controls the right boom tilt function. Move the switch up and hold to raise the tip of the right boom and down to lower. Release the switch, the right boom will stop moving and it will remain in position.
 - D. **Main Wing Switch:** This spring-loaded-to-neutral-center toggle switch controls the field-to-transport function. Move the switch up and hold to pivot the outer boom to transport, and down to field position. Release the switch, the flip wing will stop and remain at that position.
- ▲ **IMPORTANT: Extend the cylinder completely when folding the outer boom to allow the boom to rotate until it hits the stop.**
- E. **Flip Wing Switch:** This spring-loaded-to-neutral-center toggle switch controls the flip wing fold function. Move the switch up and hold to fold the flip wing in and down to fold out. Release the switch, the flip wing will stop and remain at that position.
 - F. **Breakaway Wing Switch:** This spring-loaded-to-neutral-center toggle switch controls the breakaway wing's folding functions. Move and hold the switch up to fold in for transport and down to fold out to field position.
 - G. **AutoFold:** This spring-loaded-to-neutral-center toggle switch controls the XRT Boom Folding system. "In" moves the Boom to transport position, and "Out" moves it to field position. Double tap the switch in the "Out" position to start automatic control of Boom height.
 - H. **Yaw Control:** This spring-loaded-to-neutral-center toggle switch controls the XRT Boom pivoting control. It is automatically enabled when the AutoFold switch is activated.
 - I. **Master:** This toggle controls the XRT system's power.

CONTROLLER INSTALLATION

Each control box should be mounted in the tractor cab.

Spray Circuit Controller



The control box is equipped with a "U" bracket secured by knobs on each end of the box. It provides a universal mounting system adaptable to any configuration.

Use the two holes provided in the bracket to mount the box to a solid surface. Position the box to face the operator and tighten the knobs to hold the box in position.

Cut the power cable to the required length. Connect the white wire to ground and the red wire to a 12-volt battery or power port. Refer to Controller's Manual. The panel fuse is an AGC-15 amp.

▲ IMPORTANT: Do not connect across a 24-volt system. It will damage internal electrical components.

Boom Function Control Box



Mount the box next to the sprayer controller to allow easy access. Connect to 12-volt power port. The box's fuse is an AGC-10 amp.

Plug the wiring harness from the trailer into the plug on the connector that comes from the Boom Function Control Box. Make sure to properly index the connector.

Agitation & Rinse Control Box



Mount the box next to the Boom Function Control Box. Connect to 12-volt power port. The box's fuse is rated 7.5A.

Connect the wiring harness to the matching connectors from the trailer. Make sure to properly index each connector.

ATTACHING and DETACHING

Attach the Machine Safely

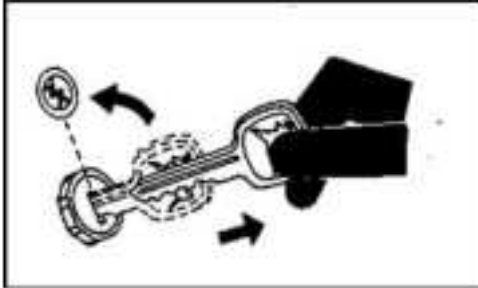

- ⚠ **CAUTION:** Prevent personal injury caused by unexpected movement of the machine. Engage the tractor's parking brake and/or place transmission in PARK, shut off the engine, and remove the ignition key before working around the hitch.

Make Proper Hose Connections



- ⚠ **WARNING:** Escaping fluid under pressure can penetrate the skin and cause serious injury. Avoid the hazard by relieving pressure before disconnecting any hydraulic or other pressurized lines. Tighten all connections before applying pressure. Search for leaks with a piece of cardboard. Protect hands and body from high-pressure fluids.

If an accident occurs, see a doctor immediately. Any fluid injected in the skin must be surgically removed within a few hours or gangrene may result. Doctors unfamiliar with this type of injury should reference a knowledgeable medical source. Such information is available from Deere &

Company Medical Department in Moline, Illinois, U.S.A.

- ⚠ **IMPORTANT:** Hydraulic hoses can fail due to physical damage, kinks, age, and exposure. Check hoses regularly. Replace damaged hoses.
- ⚠ **IMPORTANT:** All hydraulic couplers must be clear of debris, dust, and sand. Use protective caps on fluid openings until ready to make connection. Foreign material can damage the hydraulic system.

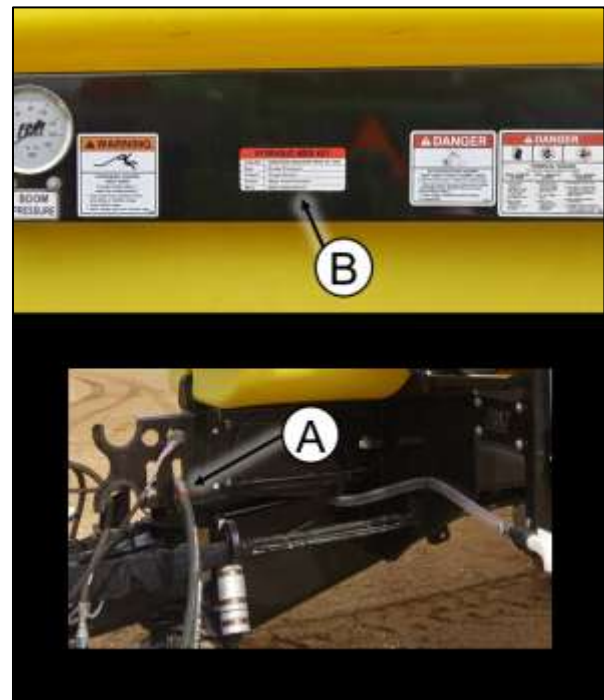

- A. SCV Marker
- B. Hose Key Chart

Identify the SCV marker color (A) and then use the hose key chart (B) to connect to the correct SCV outlet. (See [SCV Identification Chart](#))

Make sure the quick couplers are fully engaged. If the quick couplers do not fully engage, check to see that the couplers are the same size and type.

Attach the Machine to the Tractor

⚠ CAUTION: Make sure that all bystanders are clear of the working area.

1. Make sure there is enough room and clearance to safely back up to the machine.
2. Slowly back the tractor until holes on the hitch and drawbar are aligned.
3. Install drawbar pin and retainer.
4. Attach safety chain (see [Attach Safety Chain to Tractor](#)) securely around tractor drawbar cage to prevent unexpected separation.
5. Check that the Sprayer hydraulic system is compatible with the tractor's hydraulics: [Hydraulic System Requirements](#). Change the choice of the Sprayer model if required. Do not operate unless tractor and implement hydraulics are compatible.
6. Connect Hydraulics



⚠ WARNING: Prevent serious injury or death. Relieve hydraulic system pressure before connecting hydraulic hoses.

- a. Use a clean rag or paper towel to clean dirt from couplers on hose ends and tractor couplers.
- b. Relieve pressure in the hydraulic system.
- c. Route hoses over the hitch and connect hoses to tractor couplers. Verify couplers are securely seated. See [SCV](#)

[Identification Chart](#) for hose connections.

- d. Be sure to provide slack for turning.
7. Route electrical lines over the hitch and connect to the tractor's electrical connectors. Be sure to provide slack for turning.



8. Secure the jack in its stowed position. There is a connector beneath the tongue near the front of the trailer.

Attach Safety Chain to Tractor

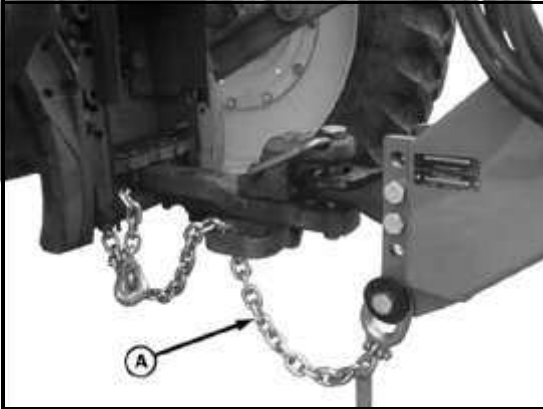

A - Safety Chain

⚠ CAUTION: A safety chain (A) will help control drawn equipment should it accidentally separate from the drawbar while transporting. A runaway machine can cause serious injury or death to you or others. Using appropriate adapter parts, attach the chain to the tractor's drawbar support. Provide only enough slack in chain to permit turning.

See your Fast Ag Solutions dealer for a safety chain with a strength rating equal to or greater than the gross weight of towed machine.

Prior to operating the implement, ensure all electrical harnesses, hydraulic hoses, and safety chain are routed properly to avoid damage.

When storing the machine, keep the safety chain up off the ground and hook it to the machine support assembly on the hitch. Always replace a safety chain if one or more links or end fittings are broken, stretched, or otherwise damaged.

Verify all chains for towed implements are adequately sized for safe transport.

Attach Warning Light Plug

⚠ CAUTION: When transporting the machine on a road or highway at night or during the day, use warning lights and devices for adequate warning to operators of other vehicles. For this matter, check local governmental regulations.

Various safety lights and devices are available from your Fast Ag Solutions dealer.



A. 7-Pin Connector Warning Light Plug

Attach a warning light plug (A) to the tractor's outlet socket.

Be sure warning lights, reflectors, and SMV emblem(s) are clean.

Connect Rate Controller or Nutrient Applicator System Wiring

See manufacturer's Manuals for connecting controller cables to the tractor.

SCV Identification Chart

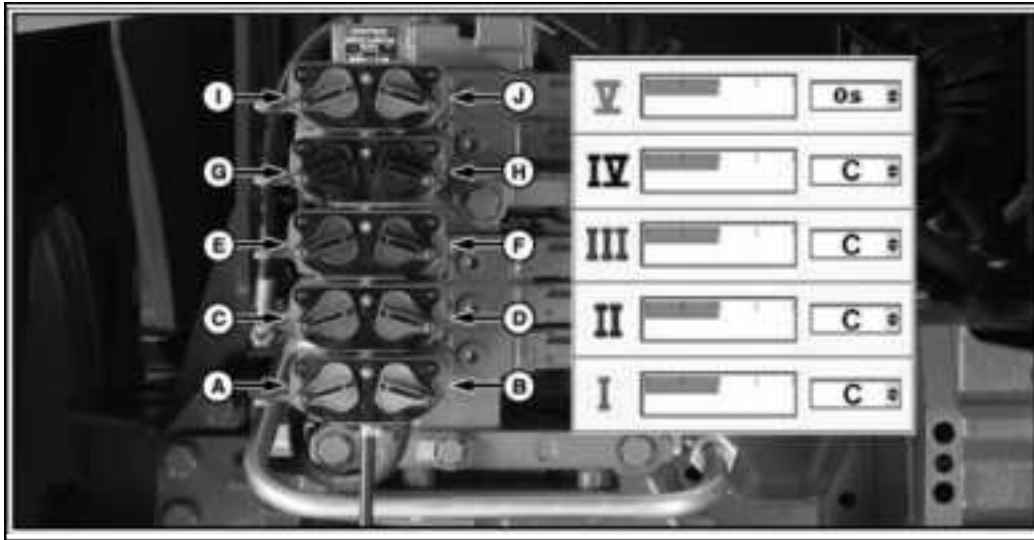

Legend	SCV ID	Tractor Flow Type	Hose Color	SCV Function
A	I	Return	Red / Black	Product Pump Return
B	I	Pressure	Red / Red	Product Pump Pressure
C	II	Return	Green / Black	Main Fold Return
D	II	Pressure	Green / Green	Main Fold Pressure
E	III	Return	Tan / Tan	Steerable Hitch Pressure
F	III	Pressure	Tan/ Black	Steerable Hitch Return
G	IV	Return	-	-
H	IV	Pressure	-	-
I	V	Return	-	-
J	V	Pressure	-	-

▲ IMPORTANT: Hose colors do not match SCV color

See [Hydraulic System Requirements](#) for system compatibility.

Detach Machine from Tractor

1. Secure jack as shown.



Figure 11: Wiring Harness and Hoses in Storage Position

2. Disconnect wiring harness and place in storage position.

⚠ WARNING: Prevent serious injury or death. Relieve hydraulic system pressure before disconnecting hydraulic hoses.

3. Disconnect hydraulic hoses and place them in their storage position.



A - Safety Chain

4. Disconnect safety chain (A).

Adjust Hitch Height

Verify machine is parked safely before performing hitch adjustment to avoid injury or death caused by uncontrolled machine movement.

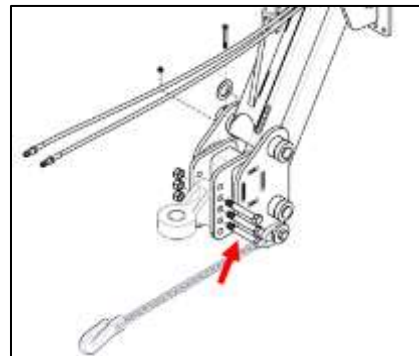

1. Remove and retain hex bolts and nuts.
2. Reinstall the hex bolts and nuts with the hitch at the desired position.
3. Tighten the hex bolts to 597 N-m (440 ft-lbs.)

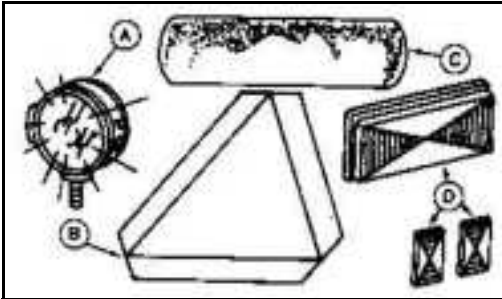
TRANSPORTING**Following Safe Transport Procedures**

- A. Lights
- B. SMV Emblem
- C. Reflector Tape
- D. Reflectors

⚠ CAUTION: When transporting the machine on a road or highway at night or during the day, use warning lights and devices for adequate warning to operators of other vehicles.

⚠ IMPORTANT: Transport Sprayer only with tank EMPTY to prevent Sprayer damage.

Check local governmental regulations.

Various safety devices are available from your Fast Ag Solutions dealer. Keep safety items in good condition. Replace missing or damaged items.

Upward force on hitch may cause instability when transporting. Add BALLAST to tractor as required.

BEWARE of overhead wires and narrow gates. KNOW the transport height and width of your machine. (See [Machine Dimensions & Specifications](#).)

Travel at a reasonable and safe speed; REDUCE speed over rough or uneven terrain, slopes, and when turning. See [Observe Maximum Transport Speed](#).

BE SURE SMV emblem, reflectors, and warning lights are clean, visible, and in good condition.

BE SURE your safety chain has a strength rating greater than the gross weight of the machine.

Preparing the Machine for Transport

Figure 12: Boom lift shutoff valve above accumulator

Fold Implement for Transport

1. Place all controls in neutral, stop the engine, and set the parking brake before proceeding.
2. Retract the transport lock pins from their cradles.
3. Open the valve to the boom lift cylinder(s) that allows the boom to raise and lower. Note that the valve might be located on the hydraulic block for some models.
4. Engage SCV I to supply hydraulic flow to the fold functions.
5. Complete the steps in either [Automatic Folding](#) or [Manual Folding](#).
6. Extend the transport lock pins in their cradles.
7. Install transport cylinder locks on both main lift cylinders.
8. Close the boom lift shutoff valve (Figure 12).
9. Disengage SCV II.

⚠ CAUTION: Never run the pump dry. Damage may occur.

- Disengage SCV III and install Steerable Hitch cylinder locks (if equipped.)

Automatic Folding

- Hold the AutoFold switch in its In position (see [Boom Function Control Box](#)) until the wings have reached their stowed position.
- Release the switch and disengage SCV I.

Manual Folding



- A. Left Wing Tilt Switch
- B. Center Section Height Switch
- C. Right Wing Tilt Switch
- D. Primary Wing Fold Switch
- E. Secondary Wing Fold Switch
- F. Tertiary Wing Fold Switch

- Fully raise the center section with the main wing switch (B) held in its Up position.
- Move to and hold the tertiary wing toggle switch (F) in its transport position until the tertiary wings are fully folded.
- Move to and hold the secondary wing toggle switch (E) in its transport position until the secondary wings are fully folded.
- Tilt both wings up enough to clear and enter their transport rests with the left (A) and right (C) wing tilt switches in their Up positions.
- Move to and hold the primary wing toggle switch (D) in its transport

position until the primary wings are fully folded.

- Tilt both wings down into their transport rests with switches (A) and (C) until they contact said rests.
- Disengage SCV I.

⚠ CAUTION: Be sure all bystanders are clear of the Sprayer.

⚠ CAUTION: See [Observe Maximum Transport Speed](#) in the Safety section for towing information.

⚠ IMPORTANT: Transport Sprayer only with tank EMPTY to prevent Sprayer damage.

Transport Notes and Checks

Be sure that the Sprayer is properly connected to the tractor. Always attach a safety chain between the Sprayer and the tractor and install a retainer through the drawbar pin.

Ensure that the hitch/tongue latch is fully engaged.

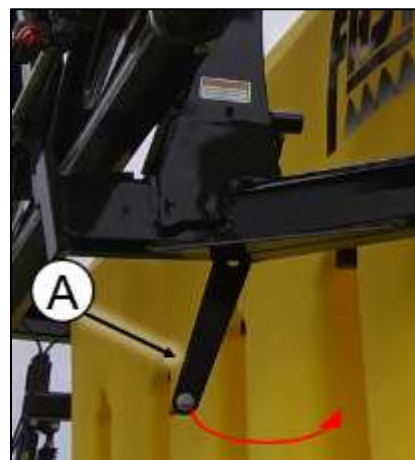

Figure 13: Boom Safety pins

Extend both transport lock pins (A) before transporting (if equipped).

Transporting the Machine

Using Warning Lights

⚠ CAUTION: When transporting the machine on a road or highway at night or during the day, use accessory lights and devices for adequate warning to operators of other vehicles. Check local governmental regulations.

Various safety lights and devices are available from Fast Ag Solutions dealer. Keep safety items in good condition. Replace missing or damaged items.

During periods of limited visibility, use pilot vehicles and use extra lights on the machine.

During normal transport, both amber warning lights will flash in unison at high intensity and both red lamps will illuminate steadily at low intensity.

When a turn is signaled, red and amber tail lamps in the direction of turn will flash at high intensity and in unison. On the opposite side, amber and red lamps will illuminate steadily at high intensity.

Keep Riders Off the Machine

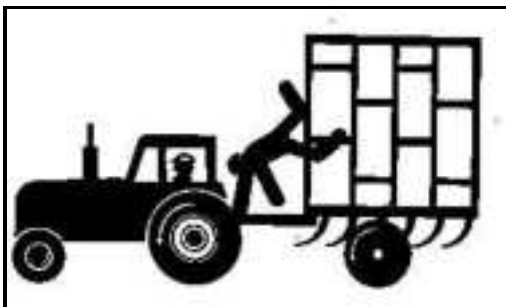

Riders are subject to injury such as being struck by foreign objects and being thrown off the machine. Riders obstruct the Operator's view resulting in the machine being operated in an unsafe manner.

Caution for All Machines

⚠ CAUTION: When transporting the machine on a smooth surface road, do not exceed the maximum transport speed of 32 km/h (20 MPH). Reduce speed considerably when traveling over rough ground.



Reduce speed when turning. Do not uncouple tractor brake pedals and apply individually in an attempt to make a tighter turn.



Serious injury or death can result from contact with electric lines. Use care when moving or operating this machine near electric lines to avoid contact. Know transport height and width of machine. Check local regulations before transporting. (See [Machine Dimensions & Specifications](#) for transport height and width of machine.)

Transport with wings fully folded. Never raise or lower the center section or wings when moving. After folding, ALWAYS place the fold valve(s) in the neutral position for transport.

If wing-fold cylinders are removed or damaged, chain wings together to prevent injury or death caused by accidental falling of wings on you or others.

Preparing the Machine for Field Use



- ▲ WARNING:** Prevent serious injury or death. The machine coming near or contacting power lines can cause electrocution. Electrocution can occur without contact. Fully lower wings before moving or transporting.

Unfolding/Extending the Boom

1. Place all controls in neutral, stop the engine, and set the parking brake before proceeding.
2. Retract the transport lock pins (Figure 13) from their cradles.
3. Open the valve (Figure 12) to the boom lift cylinder(s) that allows the boom to raise and lower. Note that the valve might be located on the hydraulic block for some models.
4. Engage SCV I to supply hydraulic flow to the fold functions.
5. Complete the steps in either [Automatic Unfolding](#) or [Manual Unfolding](#).
6. Remove and store the transport cylinder locks and Steerable Hitch cylinder locks (if equipped.)

Automatic Unfolding

1. Hold the AutoFold switch in its Out position (see [Boom Function Control Box](#)) until the wings have reached their field position.
2. Release the switch.
3. Double tap down the AutoFold switch to start the AutoBoom control. AutoYaw is already active from using said switch.



- A. Left Wing Tilt Switch
- B. Center Section Height Switch
- C. Right Wing Tilt Switch
- D. Primary Wing Fold Switch
- E. Secondary Wing Fold Switch
- F. Tertiary Wing Fold Switch

Manual Unfolding

1. Fully raise the Boom with the center section switch (B).
 2. Using the left (A) and right (C) wing switches, tilt the wings up above their transport rests.
 3. Rotate the wings 90° with the primary wing switch (D).
 4. Unfold the secondary and tertiary wings from the primaries with switch (E).
 5. Unfold the tertiary wings from the secondaries with switch (F).
 6. Lower the Boom with switch (B).
- ▲ IMPORTANT:** Extend the tertiary wings until their cylinders are fully extended. The wing stop must be in contact with both wings.

HYDRAULIC FLOW

Regulating Hydraulic Flow to the Pump

Locate your tractor model and follow the appropriate setup instructions.

▲ WARNING: FAILURE TO REGULATE OIL FLOW WILL CAUSE MOTOR FAILURE.

▲ WARNING: NOT SUITABLE FOR PUMPING FLAMMABLE LIQUIDS.

Load Sensing Closed Center System (LS Closed)

Regulate oil flow with the tractor's FLOW CONTROL and FLOW LIMITER. (Do not use restrictor orifice.)



Figure 14: Flow Limiter



Figure 15: Flow Control

Setup Instructions:

1. (Optional) Remove adapter and install flow limiter in motor inlet port (marked I).
2. Close motor needle valve: loosen jam nut, screw needle valve clockwise until seated, and lock jam nut (factory setting.)
3. Shut off toolbar boom and agitation valves if equipped.
4. Adjust tractor flow control to minimum flow setting (Turtle).

5. Move hydraulic lever to "Lower/Retract" position to start pump.
6. Adjust tractor flow control until the toolbar shut-off (deadhead) pressure is within the pump's operating parameters. **Note:** If the flow limiter stops oil flow to the motor:
 - a. Move hydraulic lever to "Float" or "Neutral" to remove oil pressure from the flow limiter.
 - b. Adjust tractor flow control to a lower flow position.
7. Repeat steps 5 and 6.
8. Open the agitation valve(s).

Pressure Compensating Closed-Center System (PC Closed)

Regulate oil flow by using a RESTRICTOR ORIFICE. (Do not use flow limiter.)

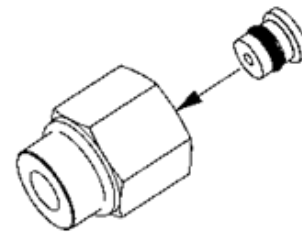

Figure 16: Restrictor Orifice

Setup Instructions:

1. Install restrictor orifice by inserting inside the adapter/restrictor body in the motor inlet port (marked I).
2. Close motor needle valve: loosen jam nut, screw needle valve clockwise until seated, and lock jam nut (factory setting.)
3. Set "Rabbit/Turtle" flow control to "Turtle".
4. Move hydraulic lever to the "Lower/Retract" position to start pump.
5. Adjust "Rabbit/Turtle" flow control and agitation valve(s) to get desired injection pressure.

Open Center System (Open)

Select motor size closest to tractor's hydraulic system capacity. Regulate oil flow with motor NEEDLE VALVE.

If using this system (not recommended), an open-center to folding-block conversion is advised. Consult the factory for PNs 630036/630037, 1 each.

(Do not use restrictor orifice or flow limiter.)

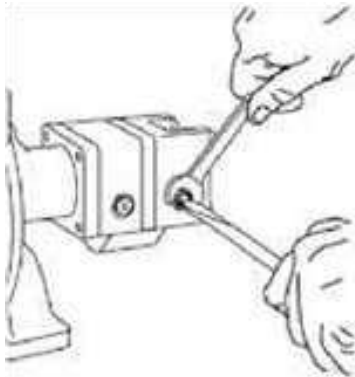

Figure 17: Closing the Needle Valve

Setup Instructions:

1. Shut off chemical/product supply and any tank agitation valves.
2. Loosen jam nut on motor and back out needle valve 3 or 4 turns counterclockwise.
3. Set tractor throttle to sprayer operating speed.
4. Move hydraulic lever to "Lower/Retract" position to start pump.
5. Screw needle valve clockwise until sprayer (deadhead) pressure is within the pump's operating parameters and lock the jam nut.
6. Open the sprayer agitation valve to get desired injection pressure.

Tractor SCV Functions

See [SCV Identification Chart](#) for connections.

NOTE: The illustrations in this Manual are for explanatory purposes only. Your control system may differ in appearance and function.

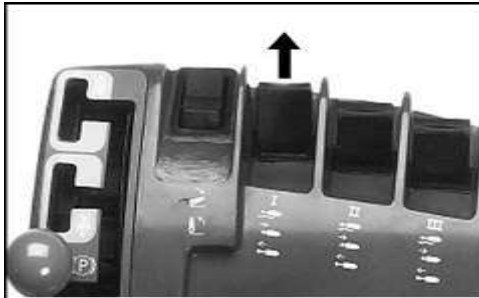

Figure 18: SCV I Pushed Forward

When the tractor's SCV I is pushed forward, the following functions are enabled:

1. Supplies hydraulic oil flow to the fold functions.

CAUTION: The SCV I function must be left pushed forward whenever the AutoBoom control is active.

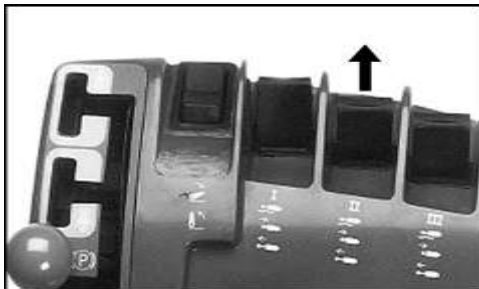

Figure 19: SCV II Pushed Forward

When the tractor's SCV II is pushed forward, the following functions are enabled:

1. Engages the main product pump drive motor.



Figure 20: SCV III Pushed Forward

When the tractor's SCV III is pushed forward, the following functions are enabled:

1. Supplies hydraulic oil flow to the Steerable Hitch block (if equipped.)

Steerable Hitch Adjustment

See [Steerable Hitch Calibration](#).

SPRAYER CALIBRATION

A sprayer can only apply the proper amount of chemicals when each component in the system is functioning properly. Chemical action in the field is dependent upon the accurate application of minute amounts of the spray compound. A complete calibration of the machine is required at the start of each season or when changing chemicals during the spray season.

It is the responsibility of the customer to determine the amount of chemical that they want to apply for their particular application. Many factors affect how much chemical is applied such as: nozzle flow rate, chemical circuit pressure, pump speed, and ground speed, to name a few.

In this section, instructions are given on how to accurately determine flow- or application-rates and how to change them. It is recommended that this procedure be followed carefully so you know exactly how much chemical is being applied.

Work closely with your chemical supplier, nozzle manufacturer, and pest control specialists to equip and operate your machine to obtain the best results. Several nozzle types are available for the sprayer. Use the type appropriate for your application.

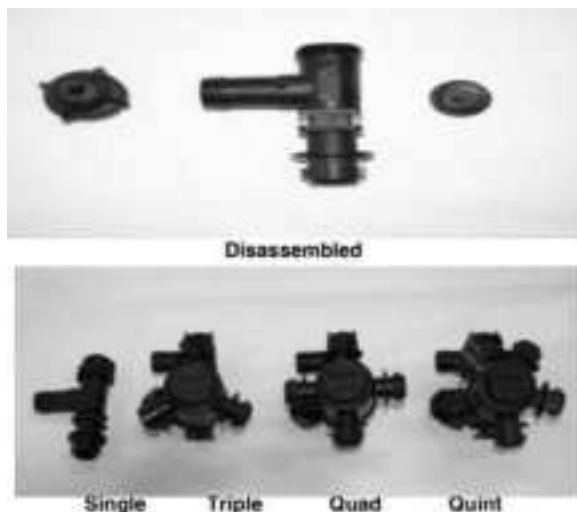

Figure 21: Nozzles typical for a dry boom



Figure 22: Wet boom triple and single assemblies

Set Engine RPM

Although the exact value of the engine speed is not particularly important to sprayer function, it is recommended that it always be set at 2/3 or more throttle position. This will ensure that there will be sufficient oil flow through the hydraulic system and sufficient power to maintain the ground speed.

Select the desired engine RPM and always perform the calibration and run in the field at the same setting.

Controller Calibration

The controller must be set and calibrated for your specific machine. Refer to the Controller's Manual and follow its Calibration procedure. Use the same controller settings during sprayer component calibrations as used in the field.

The automatic controller will adjust the chemical circuit to provide for a uniform application rate when ground speed changes up to +/- 20%. However, the system must be calibrated to determine the application rate at the nominal starting point.



Nozzle Calibration

Consult your dealer or the factory to determine the type of nozzles on your machine and their specific nominal flow rate. To determine or set the application rate, the flow rate of solution through the nozzles must be known. Operate the tractor at the same RPM and hydraulic setting as if running in the field. Start with the chemical circuit pressure at 20 PSI. Increase or decrease pressure as required to obtain the desired flow rate.

⚠ CAUTION: Never calibrate nozzles with active chemical in the tank. The solution can contaminate people, the workplace, and the environment.

⚠ NOTE: If the Controller cannot produce the required pressure in the chemical circuit, decrease the agitation flow to reset the system and try again.

⚠ NOTE: Measuring the flow rate for each nozzle will ensure a consistent and uniform spray pattern across the entire machine.

1. Remove all the nozzles from the Sprayer.
2. Use clean water to wash each nozzle and the check valve.
3. Reinstall the nozzles in the booms.
4. Add clean water until the tank is half full.
5. Place a calibration cup under all the nozzles on each boom. Calibration cups are available from most agricultural offices or weed supervisors.
6. Run the tractor at the RPM selected for field operation. Operate the chemical circuit pump at the desired pressure and measure the time that it takes to spray 0.95 liters (1.0 quart) through each nozzle. Use Table 4 to determine a per nozzle flow rate.
7. Replace all nozzles giving more than 110% the nominal flow rate.

8. Clean all nozzles components from nozzles less than 90% the nominal flow rate, and then recheck them.

Machine Yard Calibration

After the nozzles have been calibrated, it is recommended that the entire system be calibrated. A yard run is the simplest method to determine the total volume delivered. To calibrate in the yard, follow this procedure:

1. Fill the tank full of water (no chemicals.)
2. Check that all screens are clean.
3. Set the chemical system and boom pressure to the desired value and run the tractor at the selected engine RPM.
4. Spray in a stationary position for a known period of time.
5. Refill the tank and accurately measure the amount of water used. This will give the amount of spray used per time.

The total volume can be changed by increasing or decreasing the chemical system pressure. However, if a change is made, it is recommended that the entire system be calibrated again to determine the new volumes.

Ground Speed Calibration

For optimum spraying results, it is important to maintain a known, constant speed to spray the required chemical over a given area. Because of wheel slippage, the operator cannot rely on the tractor speedometer reading to give the value of true ground speed. The unit must be timed over a known distance to determine true ground speed.

To calibrate, follow this procedure:

1. Mark off a distance of 100, 200 or 300 feet (328m, 656m, 984m) in the field to be sprayed (longer distances provide greater accuracy).
2. Place the tractor in the proper gear for a speed as recommended in Table



1 and at the selected engine RPM.
Always operate at the speed appropriate for the conditions.

Table 1: Recommended application speeds

Plant type	MPH	KPH
Cereal (Broadcast)	6 – 12	9.7 – 19
Row Crops	5 – 10	8.1 – 16
General	6 – 8	9.5 – 13

3. With the tank half-full of water, drive the tractor and sprayer through the measured distance.
4. Record the time required to travel the measured distance.
5. Determine the actual tractor speed from



SPRAYER CALIBRATION

6. Table 5. Recalibration is recommended per speed chosen.

▲ IMPORTANT: Always operate at the engine RPM that will be used while spraying the field.

If the machine is equipped with the automatic controller, the ground speed can be changed by up to 20% without making adjustments. However, do not decrease the throttle below its 2/3 setting.

Area Coverage

To determine application rates, it is necessary to know the area covered by the sprayer per unit distance. Table 2 gives the area for seven widths.

Table 2: Actual Sprayer coverage

Sprayer Width	Acres		Hectares	
	1/2 mile	1/4 mile	1/2 km	1/4 km
60'	3.64	1.82	1.45	0.73
80'	4.85	2.42	1.94	0.97
88'	5.33	2.66	2.13	1.06
90'	5.45	2.73	2.18	1.09
100'	6.06	3.03	2.45	1.22
120'	7.28	3.64	2.90	1.45
132'	8.00	4.00	3.20	1.60

6. Divide the amount of liquid sprayed by the area covered to determine the application rate.

$$Appl. Rate = \frac{Volume\ sprayed}{Area\ covered} = \frac{gal.(L)}{acre\ (ha)}$$

Table 3: Common conversions

1 km	0.62 mile
1 ha	2.5 acres
1 g	0.035 oz.
1 kg	2.2 lbs.
1 g/ha	0.014 oz/acre
1 kg/ha	0.88 lb/acre
1 ml	0.035 fl. oz.
1L	0.264 gal (US)
1L	0.22 gal (Imp.)
1L/s	15.85 gpm (US)
1L/s	13.20 gpm (Imp.)
1 kPa	0.145 psi
1 mm	0.04 in.
1 m	3.28 ft.
1 L/ha	0.106 gal (US)/acre
1 L/ha	0.088 gal (Imp.)/acre

Field Calibration

To verify application rates in the field, follow this procedure:

1. Fill the tank to the neck with water and mark the level of water.
2. Check that all screens are clean.
3. Set the chemical system pressure to the desired value and run the tractor at the selected engine RPM in the selected gear.
4. Drive through the measured distance while spraying.
5. Refill the tank to the same mark and measure the volume used.



SPRAYER CALIBRATION

Table 4: Nozzle flow rates

U.S. Gallons		Imperial Gallons		Metric	
Time Time/qt min:sec	Flow Rate fl. oz./min	Time Time/qt min:sec	Flow Rate fl. oz./min	Time Time/liter min:sec	Flow Rate m Liter/min
6:24	5.0	8:00	5.0	7:00	143
6:40	4.8	8:20	4.8	7:18	137
6:57	4.6	8:42	4.6	7:38	131
		8:53	4.5	7:45	129
7:07	4.5			7:56	126
7:16	4.4	9:05	4.4		
7:37	4.2	9:31	4.2	8:20	120
				8:46	114
8:00	4.0	10:00	4.0		
8:25	3.8	10:32	3.8	9:10	109
8:53	3.6			9:43	103
		11:07	3.6		
9:09	3.5	11:26	3.5	10:00	100
9:25	3.4	11:46	3.4	10:19	97
				10:59	91
10:00	3.2	12:30	3.2		
10:40	3.0			11:38	86
		13:20	3.0		
11:26	2.8			12:30	80
		14:17	2.8		
12:18	2.6			13:31	74
12:48	2.5	15:23	2.6		
				14:05	71
13:20	2.4	16:00	2.5		
		16:40	2.4	15:30	69
14:32	2.2			15:52	63
		18:11	2.2		
16:00	2.0			16:33	57
		20:00	2.0		



SPRAYER CALIBRATION

Table 5: Ground speed calibration

Speed mph	Time In Seconds To Travel			Time To Travel 1/2 mile minutes:seconds
	100 ft.	200 ft.	300 ft.	
5.0	13.6	27.3	40.9	6:00
5.4	12.6	25.3	37.8	5:33
5.6	12.2	24.4	36.5	5:21
5.8	11.8	23.5	35.3	5:10
6.0	11.4	22.7	34.1	5:00
6.2	11.0	22.0	33.0	4:50
6.4	10.7	21.3	32.0	4:41
6.6	10.3	20.7	31.0	4:33
6.8	10.0	20.1	30.1	4:23
7.0	9.7	19.5	29.2	4:17
7.2	9.5	18.9	28.4	4:10
7.4	9.2	18.4	27.6	4:03
7.6	9.0	17.9	26.9	3:57
7.8	8.8	17.5	26.3	3:52
8.0	8.5	17.0	25.6	3:45
8.2	8.3	16.6	24.9	3:40
8.4	8.1	16.2	24.4	3:34
8.6	7.9	15.8	23.7	3:29
8.8	7.7	15.5	23.2	3:25
9.0	7.6	15.2	22.7	3:20
9.2	7.4	14.8	22.2	3:16
9.4	7.3	14.5	21.8	3:11
9.6	7.1	14.2	21.3	3:08
10.0	6.8	13.6	20.5	3:00
Speed km/h	Time In Seconds To Travel			Time To Travel 1 kilometer minutes:seconds
	30.5 m	61.0 m	91.4 m	
7.0	15.9	31.7	47.6	8:44
7.5	14.8	29.5	43.2	8:08
8.0	13.6	27.3	40.9	7:30
8.5	12.9	25.9	38.7	7:05
9.0	12.2	24.4	36.5	6:41
9.5	11.6	23.2	34.7	6:21
10.0	11.0	22.0	33.0	6:02
10.5	10.5	21.0	31.5	5:46
11.0	10.0	20.1	30.1	5:29
11.5	9.6	19.2	29.2	5:21
12.0	9.1	18.2	27.3	5:00
12.5	8.7	17.5	26.3	4:49
13.0	8.4	16.8	25.3	4:38
13.5	8.1	16.2	24.4	4:27
14.0	7.8	15.7	23.5	4:19
14.5	7.6	15.2	22.7	4:10
15.0	7.3	14.7	22.0	4:02
15.5	7.1	14.0	21.3	3:55
16.0	6.9	13.8	20.7	3:47

Steerable Hitch Calibration

Basic setup

1. Verify that the main lift hydraulic flow setting in the tractor is set to 3 or 30%.
2. Check that hoses are connected to the correct ports.

See the Steerable Hitch Quick Setup guide for more information.

<https://fastagsolutions.com/resources/>



ADJUST GROUND SPEED

It will be necessary to establish a travel speed and then set the flow to give the desired application rate. Always run at the established travel speed.

However, the best results are obtained when the ground speed is 8 - 13 kph (5 - 8 mph). Ground speed variations in the field will automatically be compensated.

Always operate at a comfortable speed. Do not operate so quickly that the toolbar, trailer, or tank bounces while going through the field.

Effective results require that liquid be applied at a consistent depth in a consistent manner. Machine bouncing will prevent this required consistency.

For broadcast spraying

Figure 23: Broadcast travel pattern

It is recommended that the operator makes one pass around a field to start and then spray back and forth to obtain the best results. Using a marker system helps to prevent skips or overlaps.

If your field has headlands, be sure to allow sufficient space for turning.

For row crop spraying

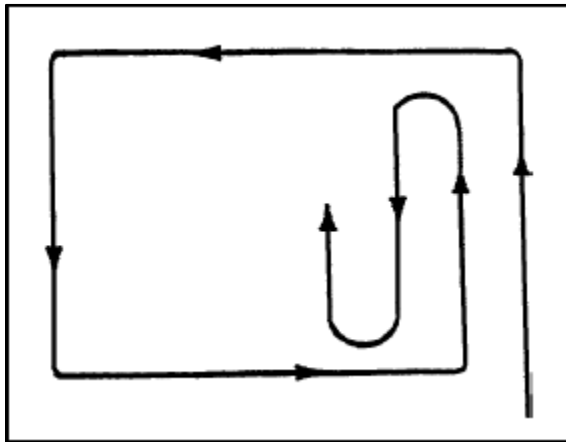
Start at one edge of the field and go back and forth until the field is completed.

Be sure the sprayer is calibrated, the nozzle height and pressure are known, and the tractor gear and RPM are determined before starting to spray (see [SPRAYER CALIBRATION.](#))

Proceed down the field at a constant speed. Use the selected gear, engine RPM and ground speed determined during the calibration of the machine application rate.

PREPARING THE LIQUID SYSTEM

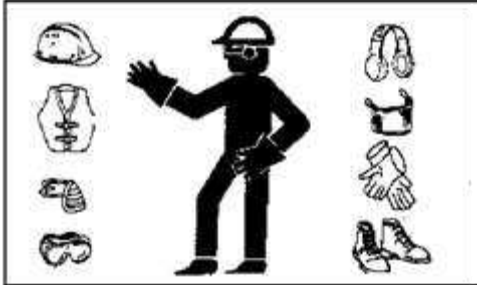

⚠ CAUTION: Prevent serious injury or death

Check the chemical or fertilizer M/SDS for proper handling instructions.

Toxic chemicals can enter the body by breathing spray or contact with bare skin.

Do not take a chance with your health and safety.

⚠ IMPORTANT: Do not run the pump dry - damage may occur.

⚠ NOTE: Always turn the sump-valve off whenever working on liquid circuit components to isolate the liquid in the tank.

Agitation & Rinse



The front valve controls the agitation circuit. Move the handle parallel to the line for

maximum agitation and perpendicular for no agitation.

It is recommended that the handle be set partially closed during operation. Provide higher rates of agitation (valve more open) if using powders.

The second valve controls the tank rinse circuit. Move the handle parallel to the line to turn the tank rinse or wash circuit on and at a right angle to the line to turn the rinse circuit off.

⚠ CAUTION: Do not exceed 50 PSI in either circuit. Damage to the rinse ball and trumpet assemblies will occur.

Clean Strainer Filter

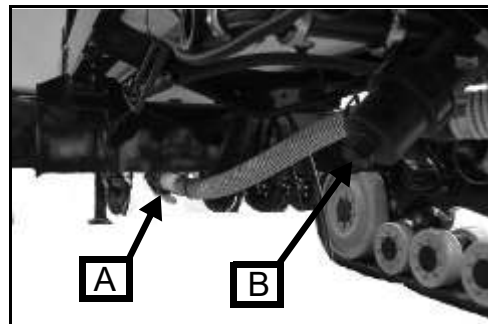

Clean the filter at the start of each day when the tank is empty or when dirt is detected in the system.

1. Clear area of bystanders.
2. Close sump valve (A) if there is liquid in the tank.
3. Relieve any pressure in the liquid circuit.
4. Remove cap (B) to access the screen.
5. Use clear water to clean the screen.

⚠ IMPORTANT: Do not overtighten the canister and crack its head.

6. Install the screen in the canister and tighten by hand.
7. Open the sump valve if there is liquid in the tank.

FILLING THE TANK

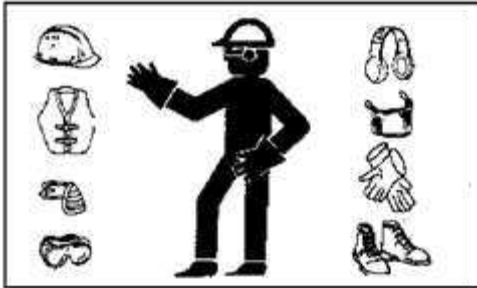

⚠ CAUTION: Prevent serious injury or death.

Check chemical or fertilizer M/SDS for proper handling instructions.

Toxic chemicals can enter the body by breathing spray or contact with bare skin.

Do not take a chance with your health and safety.

Filling the Product Tank



A. Main Tank Fill Line

⚠ IMPORTANT: Transport the machine with an EMPTY tank to prevent machine damage.

⚠ CAUTION: Add only the amount of liquid to the tank that is required for the job.

1. Position a tender truck or a drive truck next to machine.
2. Remove the fill line's (A) covers.

3. Connect a transfer hose to the bottom fill line.
4. Start the pump on the tender truck and open the valve on the fill line.
5. Pump until the tank is filled to the desired level. Do not overfill.
6. Close the input valve and stop the pump on the tender truck.
7. Remove and stow the transfer hose.
8. Install and fasten the fill line's covers.

Filling Fresh Water Rinse Tank



B. Rinse Tank Fill Line

Each machine is equipped with a freshwater rinse tank. Fill the rinse tank with clean freshwater whenever rinse water has been used. Do not allow this tank to run low on fresh water.

Use water from the rinse tank to clean, rinse or wash anything that has become contaminated.

⚠ WARNING: Do not drink the water from the rinse tank.

The rinse tank water may become contaminated with sprayer chemicals or other contaminants.

Use Tank Fill Marker

A. Fill Marker

A fill marker decal (A) is equipped to each machine to assist the Operator when filling the tank.

▲ **NOTE: The tank must be level for accurate volume readings.**

CHEMICAL EDUCTOR

⚠ CAUTION: Read the operating instructions completely before using Cleanload™.

- Always read and follow the chemical label instructions exactly. Understand safe practices for chemical handling, mixing, loading, cleaning, and first aid.
- Always wear proper Personal Protective Equipment (PPE) when handling chemicals, including gloves, eye protection, a respirator, and safety shoes.
- Always pay attention to wind conditions when dumping chemicals into the Cleanload™ hopper tank. Always stand up-wind when dumping in windy conditions. Also make sure that there are no other people downwind prior to dumping.
- Always check to make sure that there are no loose objects surrounding the Cleanload™ that could cause damage to the hopper tank or hoses.
- When operating the Cleanload™ at night, ensure lighting of 200 to 300 Lux is present.

⚠ CAUTION: IMMEDIATELY close the hopper lid and SHUT DOWN the system if leaks, errant spray, operation error, or malfunction occur.

Before Operation

1. Ensure all Cleanload™ valves are closed prior to starting and inspect them for leaks.
2. Unlock the lid by turning it counterclockwise and open it. Inspect the hopper for cleanliness, remove foreign objects, and ensure the optional hopper outlet screen is properly seated.
3. Close the lid and lock it by turning it clockwise. Gently lift the lid to ensure

it is locked closed. If the lid will not close, will not lock, or is damaged, STOP and repair it before further use.

Rinsing the Hopper

The Cleanload™ is equipped with a ProClean™ Container Rinse System. It can be used to rinse empty liquid containers using these steps:



1. Place the container to be rinsed upside down over the nozzle at the bottom of the hopper.
2. Holding the container securely with two hands, press down to activate the CONTAINER RINSE VALVE (D) for 30 seconds or longer until container is visibly clean.
3. When the container is visibly clean, stop pressing down. The CONTAINER RINSE VALVE (D) will close, and the spray will stop. Let the container drain until empty, then set it aside for proper recycling or disposal.
4. Operate the Sidewall Rinse System for 30 additional seconds or longer to flush residues, and then close the SIDEWALL RINSE VALVE (C).

Start-Up

1. Divert pump flow to the Cleanload™ inlet line.

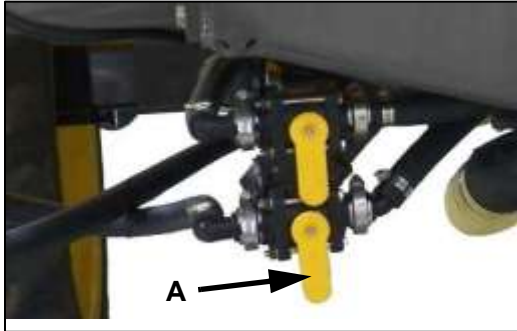

2. Open the INLET VALVE (A).



3. Open the HOPPER OUTLET VALVE (B).
4. Unlock the lid by turning it counterclockwise. Open the lid slowly, taking care to check that no errant spray is detected before fully opening the lid.

Pouring Chemical into the Hopper



1. Open the SIDEWALL RINSE VALVE (C).
2. Operate the SIDEWALL RINSE SYSTEM for 30 additional seconds or longer to flush residues, and then close the SIDEWALL RINSE VALVE (C). Using the optional Cleanload™ Suction Lance allows for loading of liquid chemicals and powders without lifting or pouring containers.
3. Measure the required amount of chemical using an accurate measuring vessel, scale, or flowmeter. The hopper should not be used as a measurement vessel.
4. Carefully pour the chemical into the hopper taking care not to splash or spill.

If equipped, one may use the optional Cleanload™ Suction Lance that allows for loading of liquid chemicals and powders without lifting or pouring containers.

5. Ensure the hopper has been rinsed of chemical residue. Remove the hopper outlet screen by pulling it straight up from the outlet and set it aside.

6. Insert the lance body into the eductor until the O-ring seals on the hopper drain.
7. Use the end of the lance to pierce a chemical bag or foil seal and suction up the chemical.
8. When the desired amount of chemical has been suctioned up, raise the end of the lance slightly out of the chemical but keep it in the container to let the lance drain out.
9. Place the end of the lance into a container of clean rinse water. Suction for 30 seconds or more to clean the lance, and then raise the end slightly out of the water to let the lance drain back into the water container.
10. Point the end of the lance up and raise it above the hopper to drain any remaining water into the eductor. Ensure the hose is fully emptied into the eductor, then remove the lance from the eductor, and pour the container of rinse water into the hopper.
11. Reinstall the optional hopper outlet screen.



1. Ensure chemical residue has been flushed from the hopper, and the rinse system valves are closed.
2. For implements equipped with a clean water rinse tank, follow the implement's manufacturer's instructions for pumping from the clean water tank during the final rinse.
3. For transfer and tender truck installations, the final rinse should be made while transferring clean water.
4. Close the lid and lock it by turning it clockwise. Gently lift the lid to ensure that it is locked closed.
5. Close the HOPPER OUTLET VALVE (B).
6. Close the INLET VALVE (A).
7. If pump flow has been diverted to the Cleanload™, divert it back for normal spraying or transfer.

Shutdown

- ▲ **NOTE:** Before shutdown, follow the steps outlined in [Rinsing the Hopper](#) to rinse the container and sidewall.





Maintenance

- ⚠ CAUTION: Divert or stop all flow to and from the Cleanload™ system before performing any service or maintenance procedures.**
- ⚠ CAUTION: Always wear proper Personal Protective Equipment (PPE) when handling chemicals, including gloves, eye protection, a respirator, and safety shoes.**
- ⚠ CAUTION: Always dispose of chemicals and contaminated water in accordance with national and local laws and statutes.**

General Cleaning

Ensure that the components of the Cleanload are free of any chemical buildup or residue, both inside and out. Failing to properly clean the system could lead to reduced performance and component life.

Be sure to thoroughly clean the eductor, ball valves and hopper. Cycle the ball valves open and close during rinsing to ensure they are clean.

Daily Maintenance

Always flush the Cleanload™ with clean freshwater after each day's use, if switching chemicals, or if the system is going to be inactive for an extended period.

Inspect all components for excessive wear, leaks, or any other damage prior to each use. Careful inspection is required before using the system after long periods of inactivity.

Yearly Maintenance

Your Cleanload™ will last longer and give its best performance when properly taken care of. Proper Cleanload™ care depends on the fluid or chemical being used and when the Cleanload™ will be used again.

At the end of the spraying season, flush the Cleanload™ with a neutralizing solution for the fluid/chemical just used. Follow with a

clean freshwater rinse. This is especially important for corrosive chemicals. Drain Cleanload™ thoroughly, open all drain plugs, and plug all ports until Cleanload™ is used again.

If the system is to be stored in below freezing ambient temperature (0°C, 32°F), flush the Cleanload™ system with once with clean freshwater and then again with antifreeze at a dilution rate specified by the antifreeze's manufacturer.



FIELD OPERATION

- ⚠ **WARNING:** Do not burn chemical containers as toxic fumes could contaminate the area.
- ⚠ **WARNING:** Do not discard chemical containers in ditches.
- ⚠ **WARNING:** Do not place containers in landfills. Dispose of them at the nearest container disposal site.
- ⚠ **DANGER:** Wear all appropriate PPE for handling chemicals.
- ⚠ **DANGER:** Do not breathe, touch, or ingest chemicals. Always wear protective clothing and follow safe handling procedures.
- ⚠ **CAUTION:** Read and understand the Operator's Manual and all safety signs before using.
- ⚠ **CAUTION:** Place all controls in neutral, stop tractor engine, turn monitor off, set park brake, remove ignition key, wait for nozzles to stop spraying before servicing, adjusting, repairing, or unplugging.
- ⚠ **CAUTION:** Before spraying a field, be familiar with all potential hazards: trees, rocks, ditches, gullies, etc. Plan the spraying route to avoid hazards. Remember you are driving a wide machine.
- ⚠ **USE CAUTION WHEN CORNERING.**
- ⚠ **CAUTION:** Keep hands, feet, hair, and clothing away from all moving and/or rotating parts.
- ⚠ **CAUTION:** Do not allow riders on the sprayer or tractor during operation or transporting.
- ⚠ **CAUTION:** Clear the area of all bystanders, especially children, before starting or filling the machine with water or chemical product(s).
- ⚠ **CAUTION:** Stay away from wing pinch points when folding or extending wings. Keep others away.
- ⚠ **CAUTION:** Stay away from power lines when extending or folding wings. Electrocution can occur without direct contact.
- ⚠ **CAUTION:** Read the chemical manufacturers' warnings, instructions, and procedures before starting and follow them exactly.
- ⚠ **CAUTION:** Spray only when potential for chemical drift is at a minimum. Even small amounts can affect neighboring crops or sensitive plants and people.
- ⚠ **CAUTION:** Dispose of chemical containers by triple rinsing them into the sprayer tank or thoroughly rinsing, crushing, and delivering to regional disposal site.
- ⚠ **CAUTION:** In case of poisoning, get immediate medical attention.
- ⚠ **CAUTION:** Only rinse sprayer while still in the field. Spray the rinse thinly over the field already sprayed. Never contaminate the farmyard or drainage systems with sprayer rinse.
- ⚠ **CAUTION:** Do not eat in the field when spraying.
- ⚠ **CAUTION:** Before applying pressure to the hydraulic system, make sure all components are tight and that steel lines, hoses and couplings are in good condition.
- ⚠ **CAUTION:** Before applying pressure to the chemical system make sure that all connections are tight and that all hoses and fittings are in good condition.
- ⚠ **CAUTION:** Review safety instructions annually.



Operation Procedure

Follow this procedure when using the Sprayer:

1. Attach Sprayer to the machine (see [ATTACHING and DETACHING.](#))
 2. Review and follow the pre-operation checklist (see [Pre-Operation Checklist.](#))
 3. Review the location and function of all controls (see [CONTROLS.](#))
 4. Read and follow chemical manufacturers' instructions.
 5. Calibrate the Sprayer so you know exactly how much chemical is being applied (see [SPRAYER CALIBRATION.](#)) The application of excess chemicals, even in small amounts, can have detrimental effects. Recalibration at the start of the season or when changing chemicals is a must.
 6. Transport the Sprayer to the working area (see [TRANSPORTING.](#))
 7. Convert into field position (see [Unfolding/Extending the Boom.](#))
 8. After arriving at the field, fill the Sprayer.
 9. Extend the hose from the supply vehicle or pump to the Sprayer. See [FILLING THE TANK.](#)
 10. Fill the tank(s).
 11. While the main tank is filling, add the chemical.
 - a. Open the main tank's agitation valve.
 - b. Start the Sprayer's pump.
 - c. Add the chemical(s) through the Top Lid, the optional [Chemical Eductor](#), or the supply vehicle's eductor. Be sure the main tank is at least half-full if adding wettable powders through the Top Lid.
 - d. If foaming occurs, add an anti-foaming additive to the tank(s).
 12. Disconnect the water hose and secure the tank cap(s).
 13. Run the product pump to allow the solution to circulate. Mix for two minutes before starting to work.
 14. Move the supply vehicle out of the way.
 15. See [ADJUST GROUND SPEED.](#)
 16. Place the Master Boom switch in the OFF position and the appropriate Boom switches in the ON position.
 17. Turn the booms ON with the Boom Master switch as the nozzles pass over the edge of the already sprayed headland and come to the area to be sprayed.
 18. Use the individual section switches as appropriate when finishing a field.
 19. When completing a pass and approaching the sprayed headland, maintain the tractor RPM and ground speed until the nozzles have covered all the plants. This will ensure a consistent application rate at the ends of the field.
- ▲ **IMPORTANT:** Add chemicals slowly. Large clumps of chemical could be drawn through line screens and plug filters.
- ▲ **NOTE:** Pre-mixing wettable powders in hot water is recommended before adding the mixture to the tank(s).
- e. Triple-rinse each spent chemical container and dispose of them properly.

Boom Tilt



Each side of the boom is equipped with a tilt cylinder that allows the operator to tilt the individual boom up at the ends of the field or whenever required to clear obstacles.

Boom Breakaway



Each boom is designed with a break-away hinge between the outer booms and the boom extension (breakaway.) Each of these hinges will “break away” when the boom strikes an obstruction to prevent damaging the boom.

Pump & Pressure



The Product Pump (liquid pump, main pump) (1) is located on the right, front side in front of the trailer.



The Liquid System Pressure Gauges (2) are in front of the rinse tank on the right side. The gauges monitor pressure in the liquid circuit providing flow to the Boom. It is normally used to monitor pressure in chemical/fertilizer circuits when setting the system for a specific application rate.

The “Pump” gauge measures pressure at the pump’s outlet. The “Boom” gauge measures pressure at the rear of the Boom’s center section near the tee fitting that sends fluid to left and right Boom Section Valves.

See [Clean Strainer Filter](#) when there is more than a 15 PSI difference between the Boom and Pump pressure readings.

LUBRICATION & MAINTENANCE

See these sections for component-specific maintenance:

- Tracks [Undercarriage Inspection and Maintenance](#)
- Chemical Educator [Maintenance](#)

Lubricating and Maintaining the Machine Safely

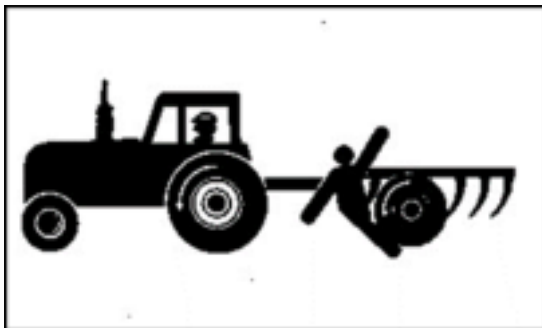

⚠ CAUTION: To help prevent serious injury or death to you or others caused by unexpected movement, be sure to service machine on a level surface.

If the machine is connected to a tractor, engage the tractor's parking brake, place the tractor's transmission in PARK, shut off the engine, and remove its key. If the machine is detached from the tractor, block wheels and use safety stands to prevent movement.

Lubricant Storage

Equipment can operate at top efficiency only when clean lubricants are used.

Use clean containers to handle all lubricants.

Whenever possible, store lubricants and containers in an area protected from dust, moisture, and other contamination. Store containers on their side to avoid water and dirt accumulation.

Make certain all containers are properly marked to identify their contents.

Properly dispose of all old containers and any residual lubricant they may contain.

Grease

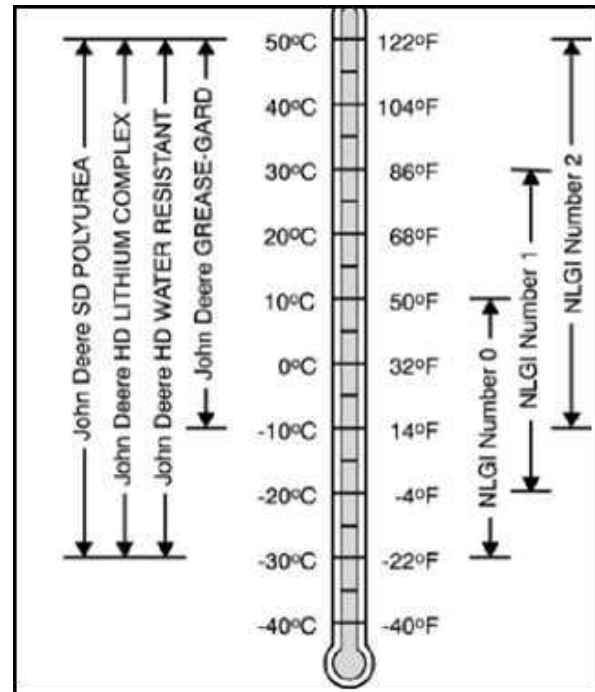

Greases for Air Temperature Ranges

Use grease based on NLGI consistency numbers and the expected air temperature range during the service interval.

⚠ IMPORTANT: Some types of grease thickeners are not compatible with others. Consult your grease supplier before mixing different types of grease.

Alternative and Synthetic Lubricants

Conditions in certain geographical areas may require lubricant recommendations different from those printed in this Manual. Synthetic lubricants may be used if they meet the performance requirements as shown in this Manual.

The temperature limits and service intervals shown in this Manual apply to both conventional and synthetic lubricants.

Re-refined base stock products may be used if the finished lubricant meets the performance requirements.

Lubrication and Maintenance Intervals

Perform each lubrication and service illustrated in this section.

Wipe the implements' grease fittings with a clean cloth before greasing to avoid injecting dirt or debris. Replace broken fittings immediately.

If a fitting will not accept grease, remove and clean it thoroughly or replace it. Clean the passageway.

Grease Bank

A centralized Grease Bank is located on the rear of the Boom center section. It connects to the major actuation points of the lift and wing joints.



Each 10 hours or Daily

- Clean the Strainer
 - It is recommended that the fertilizer strainer screen be removed and washed with clean freshwater every 8 hours.



- Grease the Boom Lift Parallel Linkages (both sides). This item is greased via the Grease Bank.



- Grease the Steerable Hitch Main Pin (2 on left side) and Cylinder Pins (4 total)



- Grease the Hitch



- Grease the Gauge Wheels (if equipped)



Each 50 Hours or Weekly

- Grease the Secondary and Tertiary Wing Fold Hinges (both sides)



Before and After Each Season

- Grease the Wheel Bearings



- Remove the Tongue Jack, remove the Top Cover (A) from the Jack, check the grease level, and reinstall the Top Cover and Jack.



- Grease the breakaway pivot (4/boom)



As Required

- Grease and lubricate the Mid Wheel, Wedges, Idler, and Mid-Roller Cap Screws with general-purpose grease at hourly interval indicated on their decal(s).

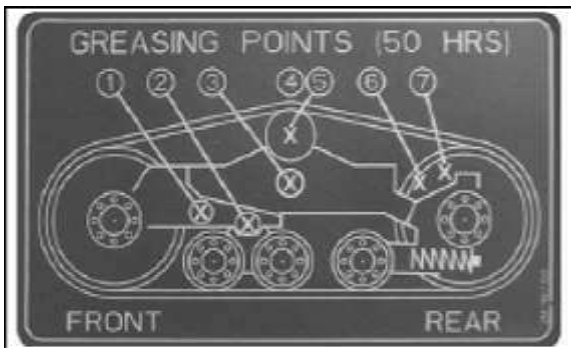

Cleaning

Filters

The fluid in the Sprayer is continually being filtered through a screen filter in the boom control feed line, agitation, and boom feed lines. The Sprayer must have clean water to prevent clogging of the screens and inline check valves when in use.

At the start of each day before the water and chemicals are added, the screens should be checked. These screens must be cleaned daily or more often as required. To clean, follow this procedure:

1. If there is water or solution in the sprayer, close valves as needed to isolate the filters.
2. Loosen the filter bodies by hand. Do not use a wrench as this could damage the filter body.
3. Remove the screens and inspect them for dirt.
4. Clean them using clean water.
5. Inspect for holes or tears. If there is damage, replace it.
6. Install the screens and body to the filter heads and tighten by hand.

▲ IMPORTANT: Do not use a wrench as this might damage the body. Do not over tighten and crack the head.

7. Open the ball valves to allow the solution to circulate.
8. Drain all screens before storage to avoid freezing.



Figure 24: Typical boom line filter/strainer



Figure 25: Pump line feed filter/strainer



LUBRICATION & MAINTENANCE

Main Tank

▲ WARNING: Do not enter the tank at any time.

Daily

At the end of the working day, clean the system using this procedure:

1. After the chemical solution has been completely sprayed out through the booms, add 75 L (20 Gal.) of clear water to the tank.
2. Run the agitation pump for 5 minutes.
3. Dispense the rinse lightly over previously worked crop.
4. Repeat Steps 1 - 3 with 110 L (30 Gal.) of water.
5. Rinse the system again with clean water.
6. Clean the screen and nozzles.
7. Drain the tank and let it dry.

To Change Chemicals or Remove Salt and Amines Formations

Perform this cleaning cycle when changing chemicals and/or annually.

1. Follow the procedure for daily cleaning.
2. Remove all screens and nozzles and wash them separately.
3. Add 200 L (50 Gal.) of clean water to the tank.
4. Add 2 L (1/2 Gal.) of household ammonia to the tank. (1-part ammonia to 100 parts water).
5. Run the agitation and rinse circuits for 5 minutes.
6. Dispense half of the solution out of the booms.
7. Let the balance sit for a minimum of 8 hours; overnight is best.
8. Run the agitation pump for 10 minutes.
9. Dispense solutions out of booms on the appropriate crop.

10. Rinse the system thoroughly with clean water and flush out the booms.
11. Drain the entire system and let it dry.

To Remove Esters of 2, 4-D and MCPA Formations

Perform this cleaning cycle when changing chemicals or annually:

1. Complete the daily cleaning.
2. Remove the nozzles and screens and wash them separately.
3. Add 200 L (50 Gal.) of clean water to the- main tank.
4. Add dishwasher detergent to the tank (2 lbs. detergent to 50 Gal.) of water (1 kg:300 L)).
5. Run the agitation and rinse circuits for 10 minutes.
6. Dispense the solution out of the booms on appropriate crops and drain thoroughly.
7. Add 200 L (50 Gal.) of clean water to the tank.
8. Add 2 L (1/2 Gal.) of household ammonia to the tank (1-part ammonia to 100 parts water).
9. Run the agitation pump for 10 minutes.
10. Dispense half of the solution out of the booms.
11. Let the balance sit for a minimum of 8 hours; overnight is best.
12. Run the agitation and rinse circuits for 10 minutes.
13. Dispense out of the booms on the appropriate crop.
14. Rinse the system thoroughly with clean water and flush out the booms.
15. Drain the entire system and let it dry.

SERVICE**Practice Safe Maintenance**

Understand all service procedures before doing work. Keep the area clean and dry.

Never lubricate, service, or adjust the machine while it is moving. Keep hands, feet, and clothing away from power-driven parts. Disengage all power and operate controls to relieve pressure. Lower equipment to the ground. Stop the engine. Remove the key. Allow the machine to cool. Securely support any machine elements that must be raised for service work.

Keep all parts in good condition and properly installed. Fix any damage immediately. Replace worn or broken parts. Remove any buildup of grease, oil, or debris.

On self-propelled equipment, disconnect the battery ground cable (-) before making adjustments on any electrical systems or welding on the machine.

On towed implements, disconnect its wiring harnesses from the tractor before servicing any electrical system components or welding on the machine.

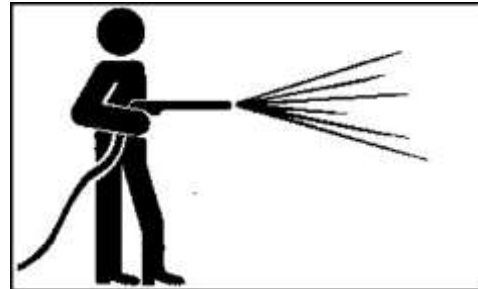
Work in a Clean Area

Before starting a job:

- Clean the work area and the machine.
- Make sure you have all the necessary tools to do your job.
- Have the right parts on-hand.
- Read all instructions thoroughly; do not attempt shortcuts.

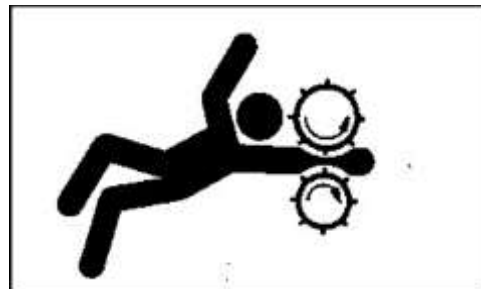
Service Machines Safely

Tie long hair behind your head. Do not wear a necktie, scarf, loose clothing, or necklace when you work near machine tools or moving parts. If these items were to get caught, severe injury could result.

Remove rings and other jewelry to prevent electrical shorts and entanglement in moving parts.

Support the Machine Properly



Always lower the attachment or implement to the ground before you work on the machine. If the work requires that the machine or attachment be lifted, provide secure support for them. If left in a raised position, hydraulically supported devices can settle or leak down.

Do not support the machine on cinder blocks, hollow tiles, or props that may crumble under continuous load. Do not work under a machine that is supported solely by a jack. Follow the recommended procedures in this Manual.

When implements or attachments are used with a machine, always follow safety precautions listed in the implement or attachment's Operator's Manual.

Avoid High-Pressure Fluids



Inspect hydraulic hoses periodically – at least once per year – for leakage, kinking, cuts, cracks, abrasion, blisters, corrosion, exposed wire braids, or any other signs of wear or damage.

Replace worn or damaged hose assemblies immediately with Fast Ag Solutions approved replacement parts.

Escaping fluid under pressure can penetrate the skin causing serious injury. Avoid the hazard by relieving pressure before disconnecting hydraulic or other lines. Tighten all connections before applying pressure.

Search for leaks with a piece of cardboard. Protect hands and body from high-pressure fluids.

If an accident occurs, see a doctor immediately. Any fluid injected into the skin must be surgically removed within a few hours or gangrene may result. Doctors unfamiliar with this type of injury should reference a knowledgeable medical source.

Preventing Hydraulic System Contamination

▲ IMPORTANT: Cleanliness is very important when working on a hydraulic system. Prevent contamination by assembling cylinders, hoses, couplers, and valves in a clean area of the shop.

Leave protective caps on fluid openings until you are ready to make a connection. When charging the system, use a tractor or other source that contains clean oil free of abrasive materials.

Keep couplers clean. Abrasive particles, like sand or metal fragments, can damage seals, barrels, and pistons causing internal leakage.

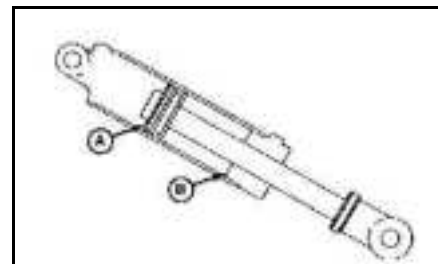

- A. Piston
- B. Rod Guide or Gland

- ▲ **IMPORTANT:** To help keep couplers clean, always place them in a storage position when they are not attached to the tractor.
- ▲ **IMPORTANT:** To prevent contaminants from entering the hydraulic system, filters must be installed at the tip of a supply hose. Additional filters are not recommended as they will restrict oil flow and adversely affect cylinder actuation time due to pressure drop.

Without a filter, large dirt particles can enter the cylinder and settle against the top side of piston (A) where they can cut the piston seal as the cylinder retracts.

Replace Hydraulic Hoses

- ▲ **WARNING:** Avoid hazards due to escaping fluid under pressure. See [Avoid High-Pressure Fluids](#).

Hydraulic hoses between the lift cylinders and hydraulic lock-up valve should be inspected frequently for leakage, kinking, cuts, cracks, abrasion, blisters, corrosion, exposed wire braids, or any other signs of wear or damage.

Worn or damaged hose assemblies can fail during use and should be replaced immediately.

See your Fast Ag Solutions dealer for replacement hoses.

- ▲ **CAUTION:** If an incorrectly rated hose is used, machine damage, injury, or death could occur.

If hoses are to be fabricated, ensure that the hoses are rated at no less than 82,737 kPa (827 bar) (12,000 PSI) burst pressure according to SAE Standard J517, 100R17 hose specification.

Incorrect hose length or routing can increase the chance of hose wear or damage. Use the

old hose as a guide for length and hose routing.

Incorrect fittings can damage mating parts or cause leaks. Make sure to use steel fittings approved for use by the hose's manufacturer. Use the correct size and thread.

Make sure hydraulic hoses and harnesses do not interfere with moving parts. Relocate hoses and harnesses and retain them with clamps.

Tightening Hardware

Tighten all bolts to torques specified in [TIGHTENING HARDWARE](#) section unless otherwise noted.

Check tightness of hardware periodically.

Breakaway Tension

Use the bolt to compress or relax the spring's clamping force on the breakaway's hinge as required.

The range of adjustment is 79.4mm – 88.9mm (3-1/8" – 3-1/2") from hard to easy pulling by one person on the end of the boom.



Aligning Booms

The booms on each machine are designed with set screw adjustments that provide a method to adjust for straightness. By keeping the booms straight, the Sprayer produces a consistent clearance to the crop.

1. Place the machine in its field configuration with the boom at a comfortable working height.
2. Place all controls in neutral, stop the engine, set the parking brake, remove the ignition key, and wait for all moving parts to stop before continuing.
3. Loosen the position bolt jam nut(s) at the hinge.
4. Turn the position bolt(s) to the required position.
5. Sight along the boom to be sure it is straight (level) at each hinge.
6. Tighten the fasteners.
7. Repeat as necessary.



Figure 26: Inner boom adjustment bolt



PREPARING FOR STORAGE

PREPARING FOR STORAGE

⚠ CAUTION: Store the unit in an area away from human activity. Do not permit children to play on or around the stored Sprayer.

At the end of the season, thoroughly inspect and prepare the Sprayer for storage. Repair or replace any worn or damaged components to prevent any unnecessary downtime at the beginning of next season.

1. Empty any remaining liquid from tank. Flush the entire system with clean freshwater.
2. Open all liquid line connections, the end cap screen canister, and pump. Drain all fluids out of the system.
3. Add approximately 38 L (10 gal) of RV antifreeze per 3 m (10 ft.) of field width to the Main Tank. Add 3.8 L (1 Gal.) of the same to the Rinse Tank.
4. Remove the 90° elbow and recap the valve block end.
5. Flush the system, then pump through screens, valves, nozzles, check valves, and orifices/tips.
6. Thoroughly wash the machine using a pressure washer to remove all dirt, mud, debris, and residue to protect against corrosion.
7. Lubricate all grease points. Make sure all grease cavities have been filled with grease to remove any water residue from washing.
8. Inspect all hydraulic hoses, couplers, and fittings. Tighten any loose fittings. Replace any hose that is damaged or is separating from the crimped end of a fitting.
9. Inspect all liquid lines and connections. Tighten any loose fittings. Replace any line that is cut, nicked, or abraded.
10. Touch up all paint nicks and scratches to prevent rusting.
11. Fold inner and outer wings to the transport configuration.

12. Install spacers on the lift cylinder rams.
13. Move the machine to a storage position.
14. Select an area that is dry, level, and free of debris.
15. Place planks under the jack for added support if required.
16. Unhook Sprayer from tractor.

Removing from Storage

1. Clear the area of bystanders, especially small children, and remove foreign objects from the machine and working area.
2. Attach the tractor to the Sprayer.
3. Check:
 - a. Attach and secure all liquid lines.
 - b. Filters and Nozzles.
 - c. All hardware. Tighten as required.
 - d. Tire pressure.
 - e. All hydraulic lines, fittings, and connections. Tighten as required.
4. Lubricate all grease fittings.
5. Replace any defective parts.
6. Add a small amount of liquid to the tank. Turn the product pump on momentarily and check that liquid comes out of each nozzle/injector.
7. Follow the [Pre-Operation Checklist](#) before using.



TROUBLESHOOTING

Problem	Cause	Solution
Sprayer is not stable. Moves from side-to-side.	Low tire pressure	Add air to tires
	Loose wheel bolts	Tighten wheel bolts
System loses pressure.	Filter screen plugged	Clean chemical line screens
	Pump worn	Check and repair or replace pump
	Faulty suction hose	Check for collapsed suction hose. Replace hose
	Faulty regulator	Replace regulator
	Hose leaking	Tighten hose or replace hose
Sprayer pressure too high.	Return hose plugged	Clean or replace hose
	Faulty pressure sensor	Calibrate sensor. Replace as required
	Faulty regulator	Repair or replace valve
	Wrong agitation valve setting	Open agitation valve slightly until pressure goes to required range
	Tip too small for volume	Check Manufacturer's tip chart for proper size
Chemical system pressure too low.	Return hose plugged	Clean or replace hose
	Faulty pressure sensor	Calibrate sensor. Replace as required
	Faulty regulator	Repair or replace valve
	Wrong agitation valve	Close agitation valve slightly until pressure goes to required range
Check valves or screens plugging.	Dirty water	Flush and clean the system. Use clean water
	Poorly mixed chemicals	Mix chemicals more slowly. Follow mixing instructions
High spray drift.	Boom set too high	Lower boom
	Too windy	Wait until wind dies down
The pump does not draw Water.	Pump is airlocked	Bleed air from pump
	Suction line is plugged or collapsed	Examine suction line. Replace as required
	Pump faulty	Replace pump



TROUBLESHOOTING

Problem	Cause	Solution
Pressure reading fluctuates.	The pump is sucking in air through the intake or air has not been entirely evacuated from the pump	Examine the suction hose and make sure it is firmly secured. Run the pump with the outlet hose open to evacuate air from pump
	Regulator broken	Replace regulator
The spray flow is irregular.	Filter screen plugged	Clean screens
	Nozzle screens plugged	Clean nozzle screens
Can't develop enough pressure.	Broken pressure regulator	Replace pressure regulator
	Worn pump	Repair or replace pump
	Leaking hose or fitting	Replace hose or tighten fitting
	Pump running too slowly	Increase oil flow to pump to increase pump speed
	Wrong agitation valve setting	Close agitation valve slightly until pressure goes to required range
	Tip size too large	Check tip capacity for proper size
No pressure reading.	Poor connection	Clean connection. Push firmly together
	Defective sensor	Replace sensor
	Defective controller gauge	Replace gauge
Spray won't shut off.	Defective switch in monitor	Replace switch
	Solenoid valve doesn't close	Magnet stuck or Spring broken. Replace defective parts
Controller doesn't control sprayer.	Blown fuse	Replace fuse
	Poor connection	Pull connections apart. Clean terminals. Reconnect
	No power	Connect power wire
	Refer to Controller Manual	Refer to Controller Manual
Booms bouncing.	Transport Safety Pins are not installed	Extend Transport Safety Pins on Boom Rests
	Traveling too fast	Slow down

TIGHTENING HARDWARE

Check the tightness of ALL BOLTS, U-BOLTS, and CAP SCREWS after the first 10-15 hours of operation and again at end of the first week (50 hours) of operation. Tighten all bolts to torques specified unless otherwise noted. Check tightness of hardware periodically.

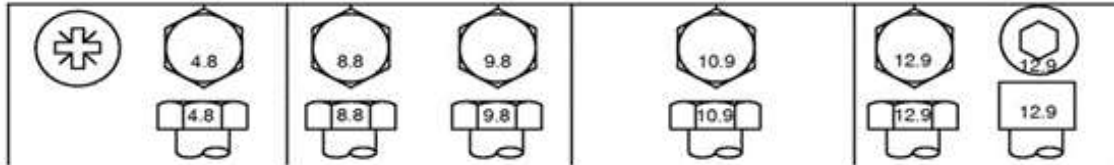

Figure 27: Common metric bolt grade markings

Metric Bolt and Screw Torque Values

Screw Size	Class 4.8				Class 8.8 or 9.8				Class 10.9				Class 12.9			
	Lubricated ¹		Dry ²		Lubricated ¹		Dry ²		Lubricated ¹		Dry ²		Lubricated ¹		Dry ²	
	N-m	lb.-in.	N-m	lb.-in.	N-m	lb.-in.	N-m	lb.-in.	N-m	lb.-in.	N-m	lb.-in.	N-m	lb.-in.	N-m	lb.-in.
M6	4.7	42	6	53	8.9	79	11.3	100	13	115	16.5	146	15.5	137	19.5	172
									N-m	lb.-ft.	N-m	lb.-ft.	N-m	lb.-ft.	N-m	lb.-ft.
M8	11.5	102	14.5	128	22	194	27.5	243	32	23.5	40	29.5	37	27.5	47	35
			N-m	lb.-ft.	N-m	lb.-ft.	N-m	lb.-ft.								
M10	23	204	29	21	43	32	55	40	63	46	80	59	75	55	95	70
	N-m	lb.-ft.														
M12	40	29.5	50	37	75	55	95	70	110	80	140	105	130	95	165	120
M14	63	46	80	59	120	88	150	110	175	130	220	165	205	150	260	190
M16	100	74	125	92	190	140	240	175	275	200	350	255	320	235	400	300
M18	135	100	170	125	265	195	330	245	375	275	475	350	440	325	560	410
M20	190	140	245	180	375	275	475	350	530	390	675	500	625	460	790	580
M22	265	195	330	245	510	375	650	480	725	535	920	680	850	625	1080	800
M24	330	245	425	315	650	480	820	600	920	680	1150	850	1080	800	1350	1000
M27	490	360	625	460	950	700	1200	885	1350	1000	1700	1250	1580	1160	2000	1475
M30	660	490	850	625	1290	950	1630	1200	1850	1350	2300	1700	2140	1580	2700	2000
M33	900	665	1150	850	1750	1300	2200	1625	2500	1850	3150	2325	2900	2150	3700	2730
M36	1150	850	1450	1075	2250	1650	2850	2100	3200	2350	4050	3000	3750	2770	4750	3500

Torque values listed are for general use only, based on the strength of the bolt or screw. DO NOT use these values if a different torque value or tightening procedure is given for a specific application. For stainless steel fasteners or for nuts on U-bolts, see the tightening instructions for the specific application. Tighten plastic insert or crimped steel type lock nuts by turning the nut to the dry torque shown in the chart, unless different instructions are given for the specific application.

Shear bolts are designed to fail under predetermined loads. Always replace shear bolts with identical property class. Replace fasteners with the same or higher property class. If higher property class fasteners are used, tighten these to the strength of the original. Make sure fastener threads are clean and that you properly start thread engagement. When possible, lubricate plain or zinc plated fasteners other than lock nuts, wheel bolts, or wheel nuts, unless different instructions are given for the specific application.

¹ "Lubricated" means coated with a lubricant such as engine oil, fasteners with phosphate and oil coatings, or M20 and larger fasteners with JDM F13C, F13F or F13J zinc flake coating.

² "Dry" means plain or zinc plated without any lubrication, or M6 to M18 fasteners with JDM F13B, F13E or F13H zinc flake coating.

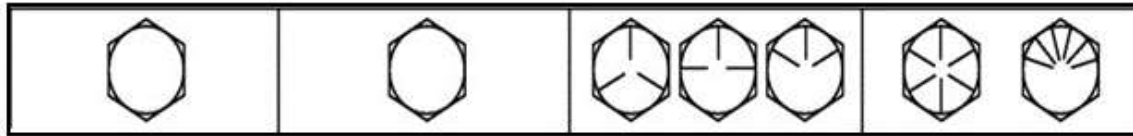

Figure 28: Common imperial bolt grade markings

Unified Inch Bolt and Screw Torque Values

Screw Size	SAE Grade 1				SAE Grade 2 ³				SAE Grade 5, 5.1 or 5.2				SAE Grade 8 or 8.2			
	Lubricated ⁴		Dry ⁵		Lubricated ⁴		Dry ⁵		Lubricated ⁴		Dry ⁵		Lubricated ⁴		Dry ⁵	
	N-m	lb.-in.	N-m	lb.-in.	N-m	lb.-in.	N-m	lb.-in.	N-m	lb.-in.	N-m	lb.-in.	N-m	lb.-in.	N-m	lb.-in.
1/4	3.7	33	4.7	42	6	53	7.5	66	9.5	84	12	106	13.5	120	17	150
													N-m	lb.-ft.	N-m	lb.-ft.
5/16	7.7	68	9.8	86	12	106	15.5	137	19.5	172	25	221	28	20.5	35	26
									N-m	lb.-ft.	N-m	lb.-ft.				
3/8	13.5	120	17.5	155	22	194	27	240	35	26	44	32.5	49	36	63	46
			N-m	lb.-ft.	N-m	lb.-ft.	N-m	lb.-ft.								
7/16	22	194	28	20.5	35	26	44	32.5	56	41	70	52	80	59	100	74
	N-m	lb.-ft.														
1/2	34	25	42	31	53	39	67	49	85	63	110	80	120	88	155	115
9/16	48	35.5	60	45	76	56	95	70	125	92	155	115	175	130	220	165
5/8	67	49	85	63	105	77	135	100	170	125	215	160	240	175	305	225
3/4	120	88	150	110	190	140	240	175	300	220	380	280	425	315	540	400
7/8	190	140	240	175	190	140	240	175	490	360	615	455	690	510	870	640
1	285	210	360	265	285	210	360	265	730	540	920	680	1030	760	1300	960
1-1/8	400	300	510	375	400	300	510	375	910	670	1150	850	1450	1075	1850	1350
1-1/4	570	420	725	535	570	420	725	535	1280	945	1630	1200	2050	1500	2600	1920
1-3/8	750	550	950	700	750	550	950	700	1700	1250	2140	1580	2700	2000	3400	2500
1-1/2	990	730	1250	930	990	730	1250	930	2250	1650	2850	2100	3600	2650	4550	3350
Torque values listed are for general use only, based on the strength of the bolt or screw. DO NOT use these values if a different torque value or tightening procedure is given for a specific application. For plastic insert or crimped steel type lock nuts, for stainless steel fasteners, or for nuts on U-bolts, see the tightening instructions for the specific application. Shear bolts are designed to fail under predetermined loads. Always replace shear bolts with identical grade.									Replace fasteners with the same or higher grade. If higher grade fasteners are used, tighten these to the strength of the original. Make sure fastener threads are clean and that you properly start thread engagement. When possible, lubricate plain or zinc plated fasteners other than lock nuts, wheel bolts, or wheel nuts, unless different instructions are given for the specific application.							

³ Grade 2 applies for hex cap screws (not hex bolts) up to 6 in. (152 mm) long. Grade 1 applies for hex cap screws over 6 in. (152 mm) long, and for all other types of bolts and screws of any length.

⁴ "Lubricated" means coated with a lubricant such as engine oil, fasteners with phosphate and oil coatings, or 7/8 in. and larger fasteners with JDM F13C, F13F or F13J zinc flake coating.

⁵ "Dry" means plain or zinc plated without any lubrication, or 1/4 to 3/4 in. fasteners with JDM F13B, F13E or F13H zinc flake coating.

Face Seal Fittings Assembly & Installation - All Pressure Applications

Face Seal O-Ring to Stud End Installation

1. Inspect the fitting surfaces. They must be free of dirt and defects.
2. Inspect the O-ring. It must be free of damage and defects.
3. Lubricate the O-rings and install them into the groove using petroleum jelly to hold them in place.
4. Push the O-ring into the groove with petroleum jelly so that the O-ring is not displaced during assembly.
5. Index any angle fittings and tighten by hand, pressing the joint together to ensure that the O-ring remains in place.
6. Tighten the fitting or nut to the torque value shown on the chart per dash size stamped on the fitting. DO NOT allow hoses to twist when tightening fittings.

Face Seal Adjustable Stud End O-Ring Installation

1. Back off the lock nut (jam nut) and washer to fully expose turned down section of the fitting.
2. Install a thimble over the fitting threads to protect the O-ring from nicks.
3. Slide the O-ring over the thimble into the turned down section of the fitting.
4. Remove thimble.

Face Seal Straight Stud End O-Ring Installation

1. Install a thimble over the fitting threads to protect the O-ring from nicks.
2. Slide the O-ring over the thimble into the turned down section of the fitting.
3. Remove thimble.

Fitting Installation

1. Install the fitting by hand until it is snug.
2. Position adjustable fittings by unscrewing the fitting no more than one turn.
3. Apply with an assembly torque per table.

Assembly Torque

1. Use one wrench to hold the connector body and one wrench to tighten the nut.
2. For a hydraulic hose, it may be necessary to use three wrenches to prevent twist: one on the connector body, one on the nut, and one on the body of the hose fitting.

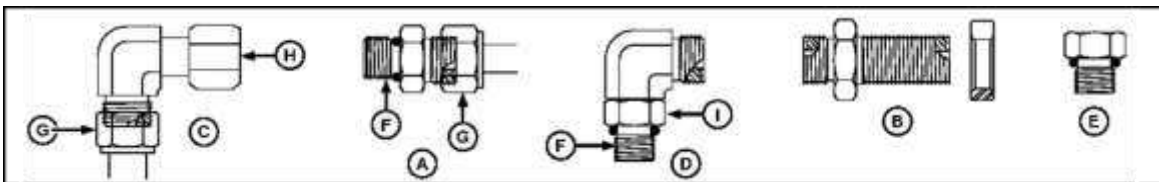

Figure 29: Common hydraulic fitting shapes and components

- | | |
|---|---------------|
| A. Stud Straight and Tube Nut | G. Tube Nut |
| B. Bulkhead Union and Bulkhead Lock Nut | H. Swivel Nut |
| C. 90° Swivel Elbow and Tube Nut | I. Lock Nut |
| D. 90° Adjustable Stud Elbow | |
| E. Port Plug | |
| F. Stud End | |



TIGHTENING HARDWARE

SAE Face Seal and O-Ring Stud End Fitting Torque Chart

SAE Face Seal and O-Ring Stud End Fitting Torque Chart - Standard Pressure-Below 27.6 MPA (4,000 PSI)																	
Nominal Tube OD Hose ID				O-Ring Face Seal/ Tube Swivel Nut				Bulkhead Jam Nut Torque			O-Ring Straight, Adjustable, and External Port Plug Stud Ends ⁶						
Metric Tube OD	Inch Tube OD			Thread Size	Swivel Nut Hex Size	Tube Nut Swivel Nut Torque		Jam Nut Hex Size	Jam Nut Torque		Thread Size	Straight Hex Size ⁷	Adj Lock Nut Hex Size	Steel or Gray Iron Torque		Aluminum or Brass Torque ⁸	
	mm	Dash Size	in.			mm	in.		N-m	lb.- ft				N- m	lb.- ft	in.	in.
5	-3	0.188	4.78	—	—	—	—	—	—	—	3/8-24	5/8	9/16	12	9	8	6
6	-4	0.250	6.35	9/16-18	11/16	16	12	13/16	32	24	7/16-20	5/8	5/8	16	12	11	8
8	-5	0.312	7.92	—	—	—	—	—	—	—	1/2-20	3/4	11/16	24	18	16	12
10	-6	0.375	9.53	11/16-16	13/16	24	18	1	42	31	9/16-18	3/4	3/4	37	27	25	18
12	-8	0.500	12.70	13/16-16	15/16	50	37	1-1/8	93	69	3/4-16	7/8	15/16	50	37	33	25
16	-10	0.625	15.88	1-14	1-1/8	69	51	1-5/16	118	87	7/8-14	1-1/16	1-1/16	69	51	46	34
20	-12	0.750	19.05	13/16-12	1-3/8	102	75	1-1/2	175	129	11/16-12	1-1/4	1-3/8	102	75	68	50
22	-14	0.875	22.23	13/16-12	—	102	75	—	175	129	13/16-12	1-3/8	1-1/2	122	90	81	60
25	-16	1.000	25.40	17/16-12	1-5/8	142	105	1-3/4	247	182	15/16-12	1-1/2	1-5/8	142	105	95	70
32	-20	1.25	31.75	1-11/16-12	1-7/8	190	140	2	328	242	1-5/8-12	1-3/4	1-7/8	190	140	127	93
38	-24	1.50	38.10	2-12	2-1/4	217	160	2-3/8	374	276	1-7/8-12	2-1/8	2-1/8	217	160	145	107
50.8	-32	2.000	50.80	—	—	—	—	—	—	—	2-1/2-12	2-3/4	2-3/4	311	229	207	153

⁶ Tolerance is +15%/-20% of mean tightening torque unless otherwise specified.

⁷ The straight hex wrench sizes listed apply to connectors only and may not be the same as the corresponding plug of the same thread size.

⁸ These torques were established using steel plated connectors in aluminum and brass.



Fast Ag Solutions
4130 Commerce Boulevard
Windom, MN 56101

1-800-772-9279 Toll Free
1-507-427-3861 Voice
1-507-427-3030 Fax

<https://fastagsolutions.com/>