

RAIN BIRD®





Simple To Set Timer (SST) Setup & Operation Instructions

English

Installation	2
Tools and Supplies Needed.....	2
Step 1. Mount Timer	2
Step 2. Connect Power.....	2
Indoor Timer	2
Outdoor Timer	2
Step 3. Connect Valve Wires To Timer	3
Valve Connections.....	3
Timer Connections.....	3
Step 4. Verify System Operation.....	4
Battery Pull Tab	4
Apply Power	4
Test Watering.....	4
Optional Accessories	5
Rain Sensor	5
Master Valve Or Pump Start Relay	5
Controls and Indicators.....	6
Setting the Timer	7
Step 1. Set Clock.....	7
Step 2. Set Date.....	7
Step 3. Schedule Watering	7
Set Start Time and Run Time.....	7
Select Watering Days.....	7
Select Watering Times Per Day.....	7
Optional Features	7
Multiple Start Times.....	7
Seasonal Adjust.....	7
Rain Delay.....	8

Normal Operation.....	8
Not Watering	8
Watering Now	8
Rain Delay.....	8
Seasonal Adjust.....	8
Error Detected.....	8
Manual Operation.....	8
Water All Zones	8
Water One Zone	8
Troubleshooting	9
Watering Issues.....	9
Electrical Issues.....	9

Symbols

-  **NOTE:** Alerts user to important operating functionality or installation instructions.
-  **WARNING:** Alerts user to the presence of electricity which may pose a risk of shock or other hazard.
-  **DIAL:** Indicates user is required to turn the timer dial to the appropriate position.

For help setting up or operating the SST timer, please call Rain Bird toll-free Technical Support at:

1-800- RAIN BIRD (800-724-6247)
or visit www.rainbird.com

Installation

Tools and Supplies Needed

- Phillips screwdriver
- Wire stripper
- Hammer
- Valve wire: direct burial, color coded multi-strand (not included)
 - 18 gauge for runs less than 800 feet.
 - 14 gauge for runs greater than 800 feet.
- Watertight splice connectors (not included)

Step 1. Mount Timer

Mount the SST in an accessible location

- !** **NOTE:** SST indoor timers are for indoor use only. SST outdoor timers can be used indoors or outdoors.
- ▶ For indoor installation, choose a location within 5 feet of an AC power outlet and at least 15 feet away from major appliances or air conditioners.
 - ▶ Drive a screw into the wall, leaving a 1/8" gap between the screw-head and the wall (use the supplied wall anchors if necessary).
 - ▶ Locate the keyhole slot on back of the unit and hang it securely on the screw.
 - ▶ Remove the wiring bay cover at the bottom of the unit and drive a screw through the center hole as shown (use the supplied wall anchors if necessary).

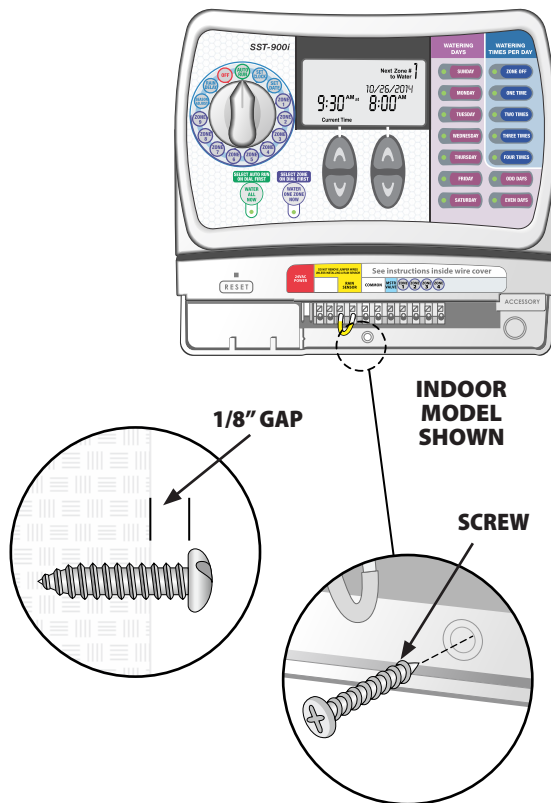

Step 2. Connect Power

⚡ WARNING: DO NOT plug in or apply power to the timer until you have completed and checked all wiring connections.

Indoor Timer

- ▶ Attach the transformer connector to the 24VAC POWER pin connection on the terminal strip.

⚡ WARNING: Do not attempt to link two or more timers together using a single transformer.

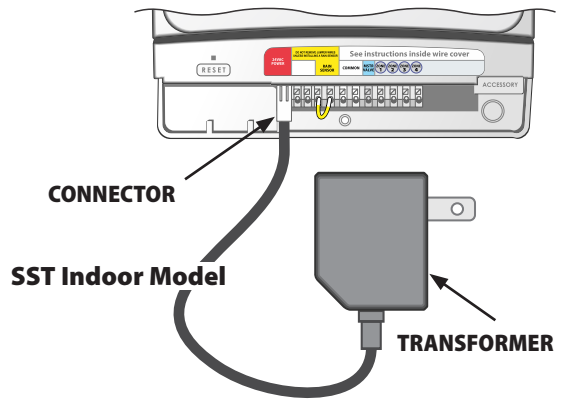

Outdoor Timer

Standard Installation

The SST outdoor version comes with a power cord and 24VAC transformer already connected.

Hard-wire Installation

⚡ WARNING: Disconnect or shut off the external power source before connecting or disconnecting wires to the timer.

- ▶ Remove the wiring bay cover at the bottom of the unit.
- ▶ Locate the wiring compartment in the lower left-hand corner of the unit and using a screwdriver, unscrew wiring compartment front cover.

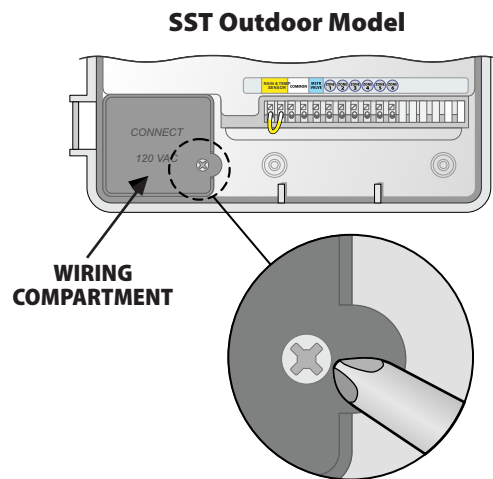

- ▶ Unscrew the wire-nuts from the three wires connecting the power cord to the timer.
- ▶ Remove the metal bracket holding the power cord to the back of the wiring compartment and pull the cord out through the bottom of the cabinet.
- ▶ Route the three wires from an external power source into the wiring compartment.
- ▶ Using the wire-nuts, connect the external power wires to the internal connection wires inside the wiring compartment.

⚠ WARNING: Be sure to connect the colored coded external wires to the same color internal connection wires, as follows:

- **Black wire (power)**
- **White wire (neutral)**
- **Green wire (ground)**

- ▶ Verify that all wiring connections are secure, then replace the wiring compartment cover.

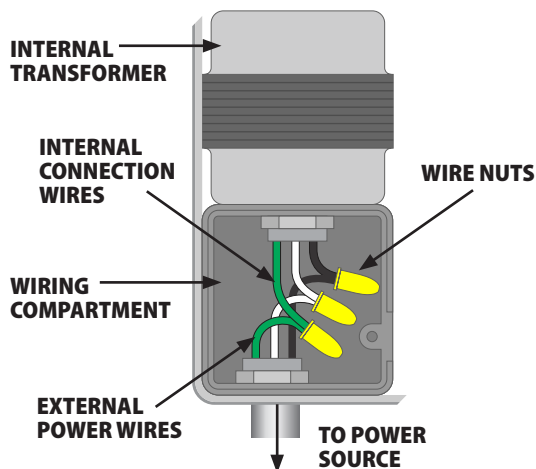

Step 3. Connect Valve Wires To Timer

Valve Connections

- ▶ Use direct burial cable to run wiring from the timer to valves in the field.
- ▶ Connect a color coded wire from the direct burial cable to either wire on the valve.
- ▶ Connect the remaining wire on each valve to a “common” wire which then connects to the timer.

⚠ NOTE: Use water-tight connectors for all wire splice connections. Depending on your landscape setup, you may need to run extension wires for the power and common connections.

Timer Connections

- ▶ Use a wire stripper to strip away approximately 1/4 in. of insulation from the end of the valve wire.
- ▶ Push the exposed end of the color coded wire from each external valve (or zone) into the corresponding zone number on the terminal block.

⚠ WARNING: To prevent damage to the timer, connect only ONE valve to each open zone slot on the terminal block.

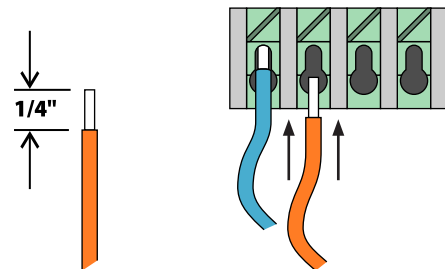

- ▶ Connect the common wire to one of the **COMMON** slots on the terminal block.
- ▶ Check that all wiring connections are secure.

⚠ NOTE: To remove a connected wire, use a screwdriver to press down on the connection release and then pull the wire out.

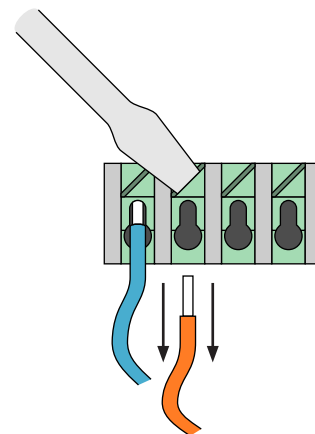

⚠ NOTE: Do not remove the yellow jumper wire on the terminals marked **RAIN SENSOR** unless you're connecting an optional rain sensor. See page 5 for more information.

VALVE AND TIMER CONNECTIONS

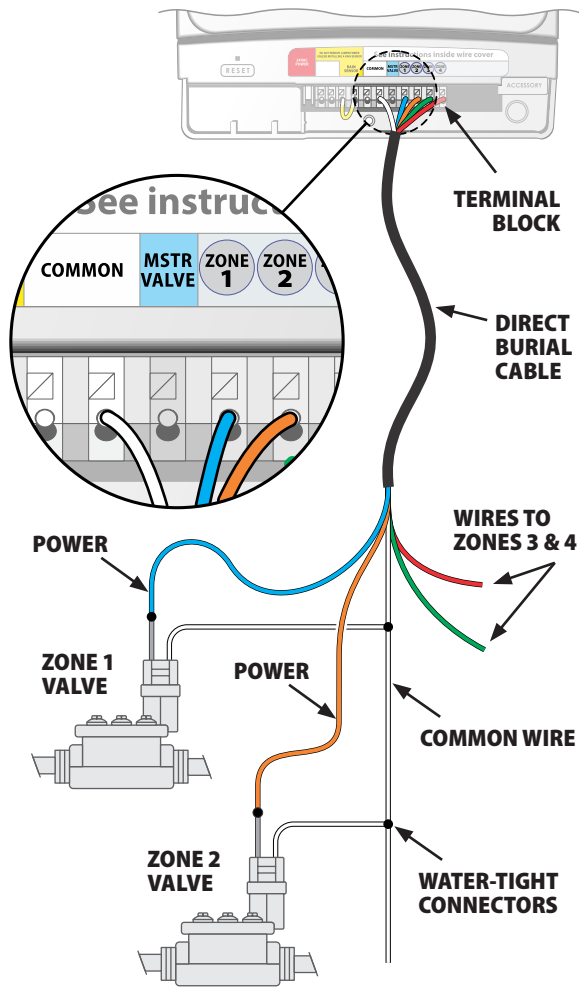

Step 4. Verify System Operation

Battery Pull Tab

- ▶ To activate the internal battery, grasp the yellow pull-tab on the side of the timer and pull it out.

Apply Power

Indoor Model

- ▶ Plug the transformer into a wall outlet.

Outdoor Model

- ▶ Turn on main power supply or plug the power cord into a waterproof receptacle.

! **NOTE:** Do not plug the timer into a socket that is controlled by a secondary ON/OFF light switch or GFI outlet.

Test Watering

- ▶ Turn the dial to the **ZONE 1** position.

▶ Press the **WATER ONE ZONE NOW** button. The zone should start watering for a default run time of 10 minutes.

- ▶ To stop watering before time is up, turn the dial to the next position.
- ▶ Repeat the above steps until all zones have been tested.
- ▶ Replace the wiring bay cover on front of the unit.

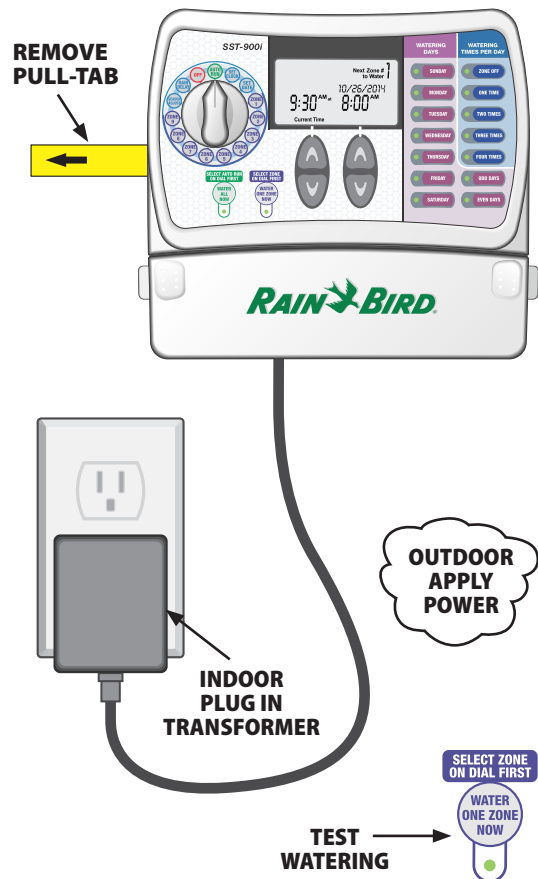

Optional Accessories

Rain Sensor

Connect an optional Rain Sensor to the Timer

- ▶ Remove the wiring bay cover at the bottom of the unit.
- ▶ Remove the yellow jumper wire from the terminals marked **RAIN SENSOR** on the terminal block.

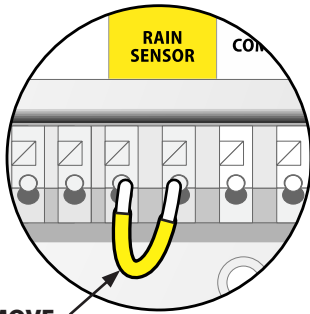

REMOVE JUMPER WIRE

! **NOTE:** Do not remove the jumper wire unless connecting a rain sensor. The timer will not function if the jumper wire is removed and a rain sensor is not connected.

- ▶ Connect the two wires from the sensor to the **RAIN SENSOR** terminals.

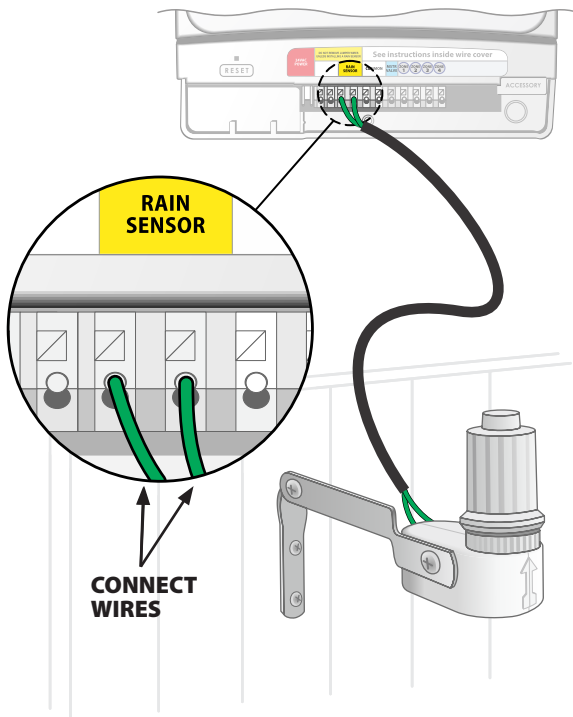

CONNECT WIRES

Master Valve Or Pump Start Relay

Connect an optional master valve or pump start relay

SST timers support the use of a master valve or pump start relay. A pump start relay connects to the timer the same way as a master valve, but connects differently at the water source.

- ▶ Using a direct burial cable, connect one of the wires from the master valve (or pump start relay) to the timer terminal marked **MSTR VALVE**.
- ▶ Using a direct burial cable, connect the remaining wire from the master valve (or pump start relay) to one of the timer terminals marked **COMMON**.

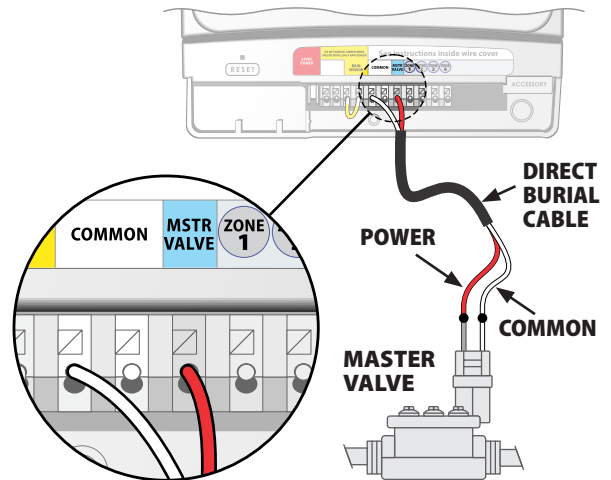

Additional instructions for connecting a pump start relay

- ▶ To avoid possible pump damage, connect a short jumper wire from any unused zone terminal(s) to the nearest zone terminal in use.

Example: if a 4 zone model timer is in use with only two zones connected, route the terminals for zones 3 and 4 to the nearest active terminal (in this example, zone 2).

⚡ WARNING: Make sure that the total draw of the master valve (and/or pump start relay) plus the draw of the valve does not exceed 650mA at 24VAC, 60hz. Note that the timer does NOT provide main power for a pump.

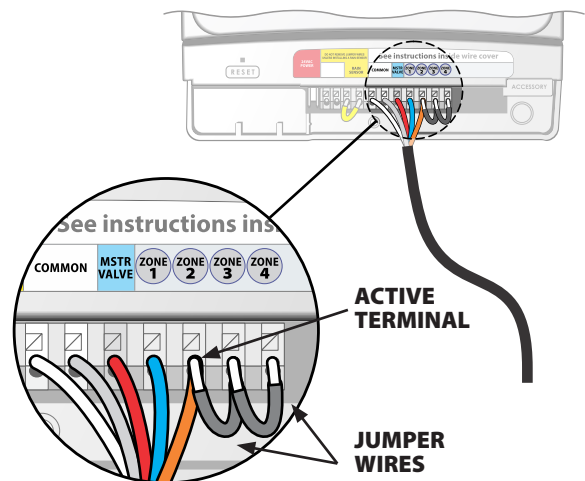

Controls and Indicators

AUTO RUN

Set dial here to run all programmed settings

OFF

Turns off all watering

RAIN DELAY

Delays watering up to 72 hours

SEASON ADJUST

Adjusts watering % as seasons change

ZONES 1-9

Select individual zone to program (9 zone model shown)

WATER ALL NOW

Sequentially waters all zones

WATER ONE ZONE NOW

Manually waters an individual zone

SET CLOCK

SET DATE

DISPLAY SCREEN

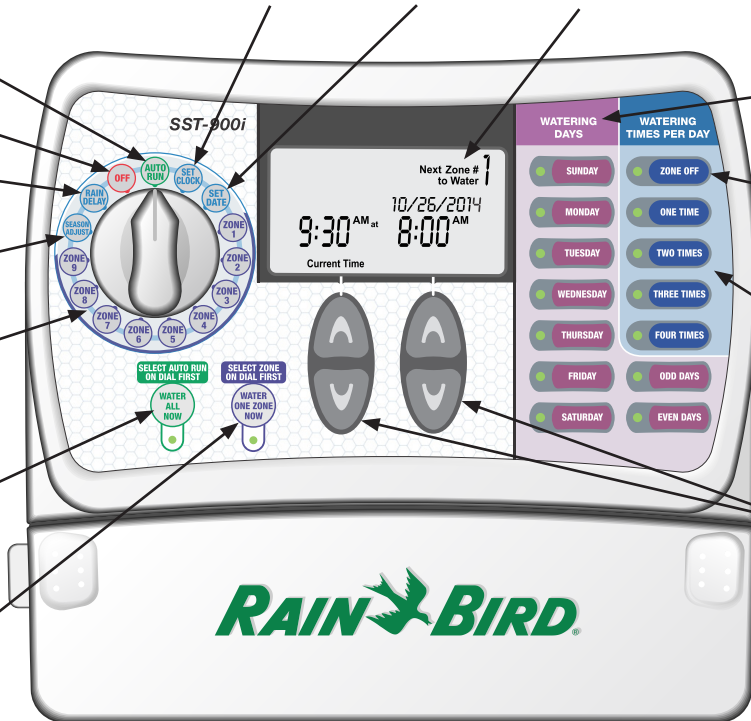

WATERING DAYS

Select which day(s) a zone is watered

ZONE OFF

Turns off watering of selected zone

WATERING TIMES

Select how many times per day a zone is watered

UP/DOWN ARROWS

Use **UP/DOWN** arrows on left or right keys to set clock, date, run time, etc.

Setting the Timer

Important!

Always return the dial to **AUTO RUN** when programming is completed. The timer will not run automatically unless the dial is set to **AUTO RUN**.

Step 1. Set Clock

Turn the dial to the **SET CLOCK** position.

Press the **UP/DOWN** arrow keys to set the time (verify AM/PM setting is correct).

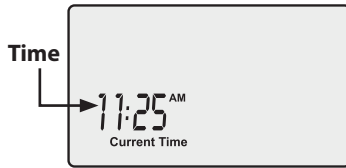

Step 2. Set Date

Turn the dial to the **SET DATE** position.

Press the **LEFT UP/DOWN** arrow keys to set the year.

Press the **RIGHT UP/DOWN** arrow keys to set the month and day.

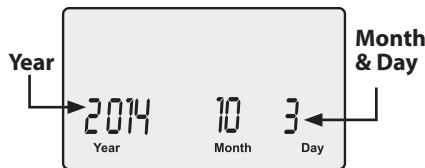

Step 3. Schedule Watering

Turn the dial to select the desired **ZONE** (from 1 to 9).

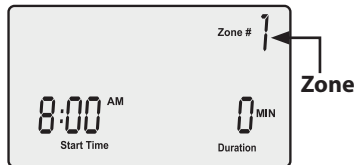

Set Start Time and Run Time

Press the Left **UP/DOWN** arrow keys to set the Start Time.

Press the Right **UP/DOWN** arrow keys to set the Run Time (duration).

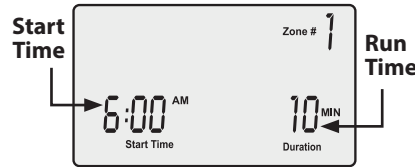

NOTE: Multiple zones having the same start time will run in sequence by zone number. For example, if zones 3 and 4 are both set to run for 10 min. at 8:00 AM, zone 3 will run first at 8:00 then zone 4 will run afterwards at 8:10.

Select Watering Days

Press the pink **WATERING DAYS** buttons to select which days to water.

Select specific days of the week or select **ODD DAYS** or **EVEN DAYS**.

Select Watering Times Per Day

Press the blue **WATERING TIMES PER DAY** buttons to select the number of times per day to water.

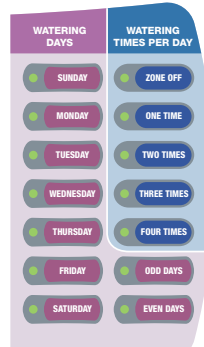

▶ Repeat Step 3 for remaining zones.

NOTE: If more than one watering time per day is selected, refer to Multiple Start Times in the next section.

Turn the dial to **AUTO RUN**.

Optional Features

Multiple Start Times

If the TWO, THREE or FOUR TIMES button is selected then several pre-defined offsets are available.

NOTE: Offsets are the number of hours between the first start time and any additional start times.

Repeatedly pressing the desired Watering Times per Day button will cycle through the available offsets.

In the example below, the **THREE TIMES** per day button was selected and the offsets are +4 and +8 hours.

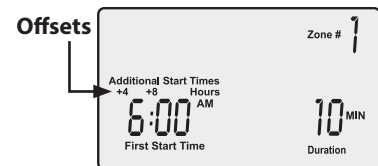

This means the SST will water three times per day as follows:

- 6:00 am (first start time)
- 10:00 am (+4 hours)
- 2:00 pm (+8 hours)

NOTE: The SST automatically resets at 12 a.m. each day. Schedule multiple start times from 12:15 a.m. -11:45 p.m.

Seasonal Adjust

Adjust for seasonal weather variation

Turn the dial to **SEASON ADJUST**.

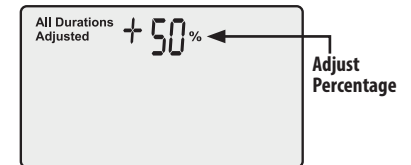

Press the **UP/DOWN** arrow buttons to adjust the percentage.

For example, a +50% adjustment means 10 min. becomes 15 min.

NOTE: Adjustment applies to ALL run times for ALL zones.

Rain Delay

Suspend watering

- Turn the dial to **RAIN DELAY**.

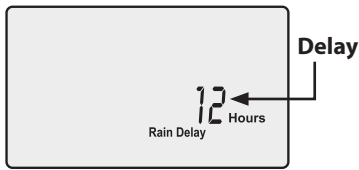

- Press the **UP/DOWN** arrow buttons to set the delay time for up to 3 days (72 hours).

NOTE: Any scheduled watering that falls within the delay period will not occur.

Normal Operation

While set to **AUTO RUN**, one of the following screens will be displayed:

Not Watering

Screen displays the current time, the zone that is scheduled to be watered next, and the date and time when watering will occur.

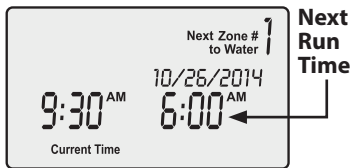

Watering Now

Screen displays the zone currently being watered and the number of minutes remaining for that zone.

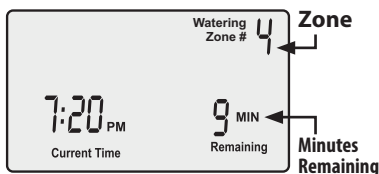

Rain Delay

Screen displays the current time and the number of rain delay hours that are left until regularly scheduled watering resumes.

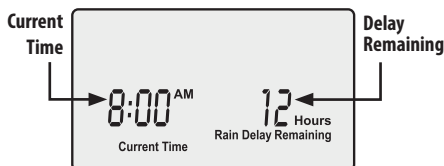

Seasonal Adjust

Screen displays the percentage adjustment for all zones.

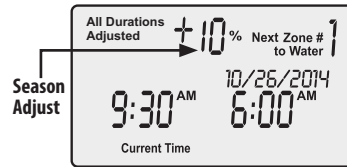

Error Detected

If an error is detected, the affected zone is displayed.

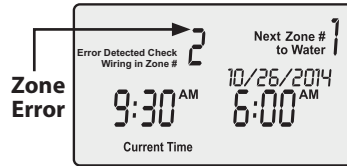

Manual Operation

Choose from two Manual Watering options:



Water All Zones

- Turn the dial to **AUTO RUN**.
- Press the green **WATER ALL NOW** button to start watering.

Screen displays which zone is being watered and the number of minutes remaining for that zone.

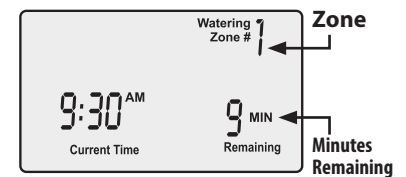

To stop watering the active zone and skip to next zone, press the **WATER ALL NOW** button again.

- To stop manual watering, turn the dial to OFF and then back to **AUTO RUN**.

Water One Zone

- Turn the dial to select a **ZONE**.
- Press the purple **WATER ONE ZONE NOW** button to start watering (default run time of 10 minutes).

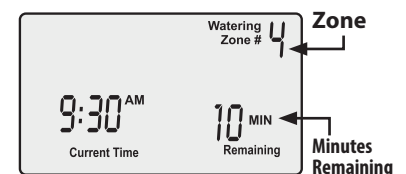

- Press the **UP/DOWN** arrow buttons to adjust the run time.

- To stop manual watering, turn the dial to **AUTO RUN**.

Troubleshooting

Watering Issues

Problem	Possible Cause	Possible Solution
Automatic and manual cycles do not begin watering.	Water source not supplying water.	Verify the main water and all supply lines are open and operating properly.
	Wires not properly connected.	Verify field wires are connected properly including the timer, master valve (or pump start relay) and any spliced connections.
	Wires damaged or corroded.	Check field wiring for damage and replace if necessary. Check all connections and replace with watertight connectors as needed.
	Dial not set to AUTO RUN position.	Verify the dial is in the AUTO RUN position.
	An installed Rain Sensor may be activated.	Operation will resume when sensor dries out. To test operation, disconnect the Sensor and connect a jumper wire between the Rain Sensor terminals.
	If no Rain Sensor is installed, the jumper wire may be damaged or missing.	Connect the two yellow Rain Sensor terminals with a short length of 14 to 18 gauge jumper wire.
	An electrical surge may have damaged the timer's electronics.	Press the RESET button under the wiring bay cover. If there is no permanent damage, the timer should resume normal operation. Note: date and time must be re-entered after reset.
Watering cycles do not shut off.	Debris trapped in valve.	Flush the valve by temporarily opening the dump hole and re-tighten.

Electrical Issues

Problem	Possible Cause	Possible Solution
LCD Display is blank.	Timer is not receiving power.	Verify the power cord is connected and securely plugged in. (indoor)
		Verify the transformer is wired correctly and the circuit breaker is on. (outdoor)
No red LED light (indoor).	Blown transformer.	Replace transformer.
LCD Display is "frozen" and timer will not accept programming.	An electrical surge may have damaged the timer's electronics.	Disconnect power to the timer for 3 minutes then turn back on. If there is no damage, the timer will accept programming and resume normal operation.
Valve short error message on LCD display.	Wires damaged or corroded.	Check the indicated zone wiring for damage and replace if necessary. Check all connections and replace with watertight connectors as needed.



Rain Bird Corporation
 6991 East Southpoint Road
 Tucson, AZ 85756 USA
 Tel: (520) 741-6100
 Fax: (520) 741-6522

© 2015 Rain Bird Corporation
 ® Registered trademark of Rain Bird Corporation

**Questions? Call 1-800- RAIN BIRD (800-724-6247)
 or visit www.rainbird.com**