

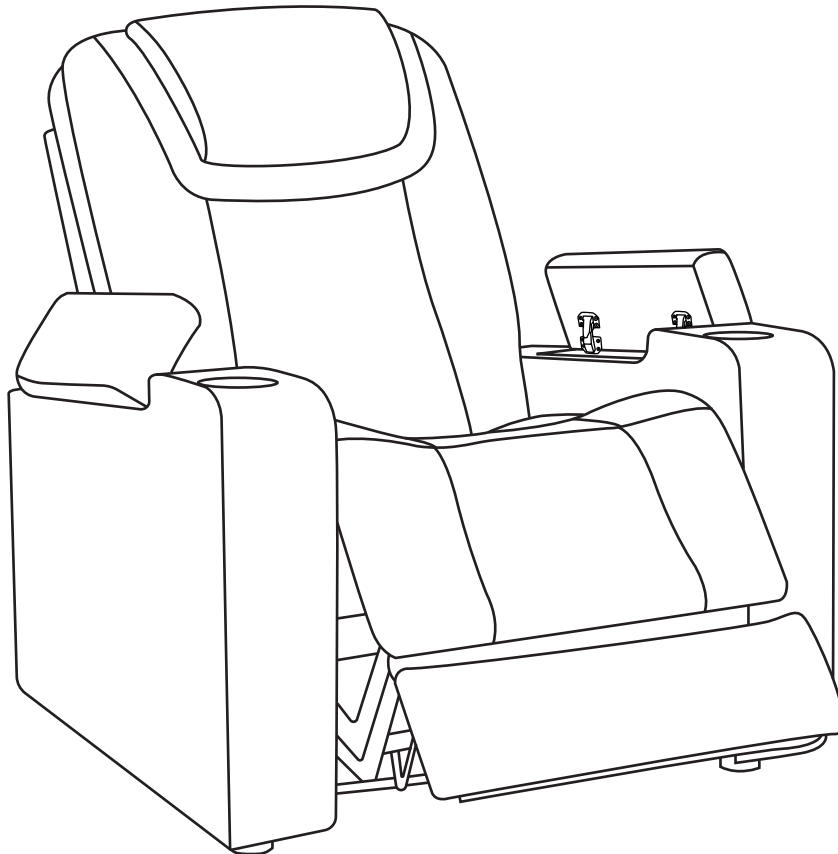

LIVING SPACES

OWNER'S MANUAL

Installation & Operation



SKU: 352262

Rev 2 09/2024

Table of Contents





Parts List	01
Installation Guide	02
Function introductions	04
Operating Instructions	05
Disassembly Instructions	08
Audio System	09

Parts List

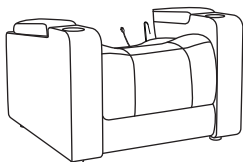

All electronics and components that need to be installed are located in bags under the foundation or attached to the frame. Before discarding the packing materials, ensure that all the parts are accounted for.

PARTS LIST				
CODE	A	B	C	D
DESCRIPTION	Back Cushion	Seat Cushion	Power Cord	Transformer
IMAGE				
QUANTITY	(1)	(1)	(1)	(1)

OPTIONAL EQUIPMENT (NOT INCLUDED)

Screwdriver

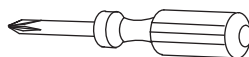

One person is required to set up the foundation. It takes about 5 minutes.

1

Detach the transformer and power cord from the back rail of the mech under the seat.

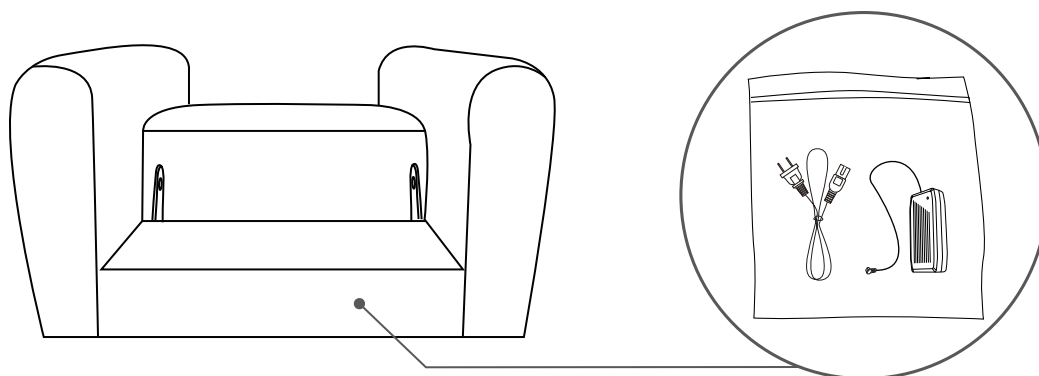

Installation Guide



2

Slide inside back receivers onto the steel mechanism posts in the base of the recliner. Press both sides of the back firmly into place until the back automatically locks into track. Zip up the seat cushion and back cushion.

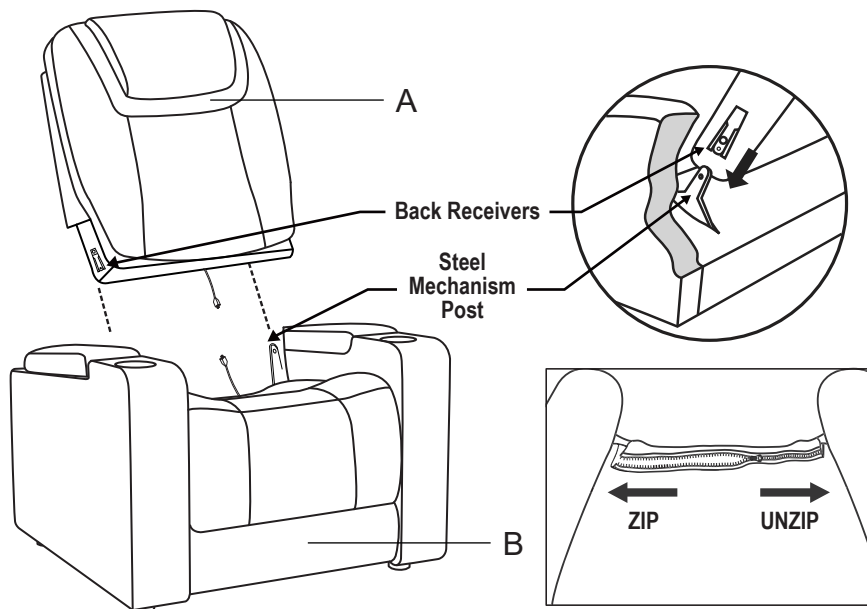

3

Flip the back flap up and connect all the cables accordingly.

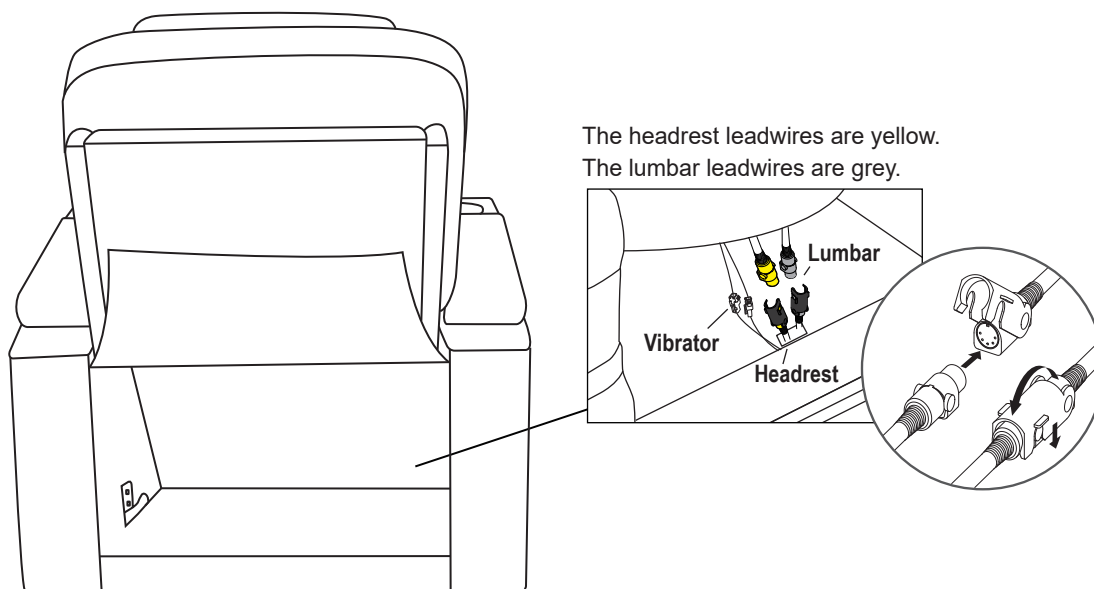

The headrest leadwires are yellow.
The lumbar leadwires are grey.

Installation Guide



4

Connect the power transformer to the socket at the bottom of the back of the recliner. Connect the Power Cord into the Power Transformer. Plug the power cord into a nearby outlet, still making sure it is clear of the metal base.

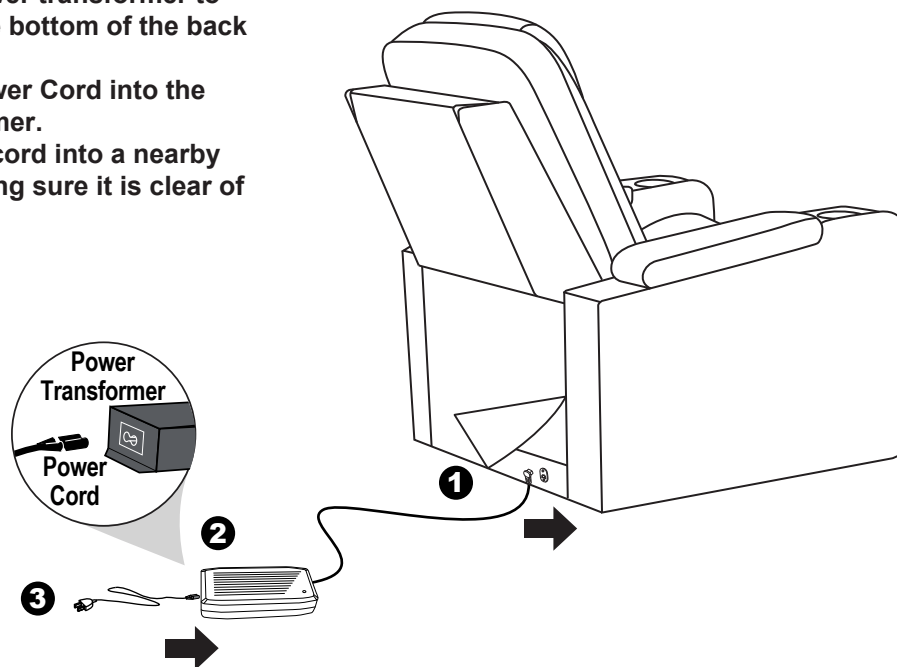

5

Fasten the back flap to the bottom of the furniture.

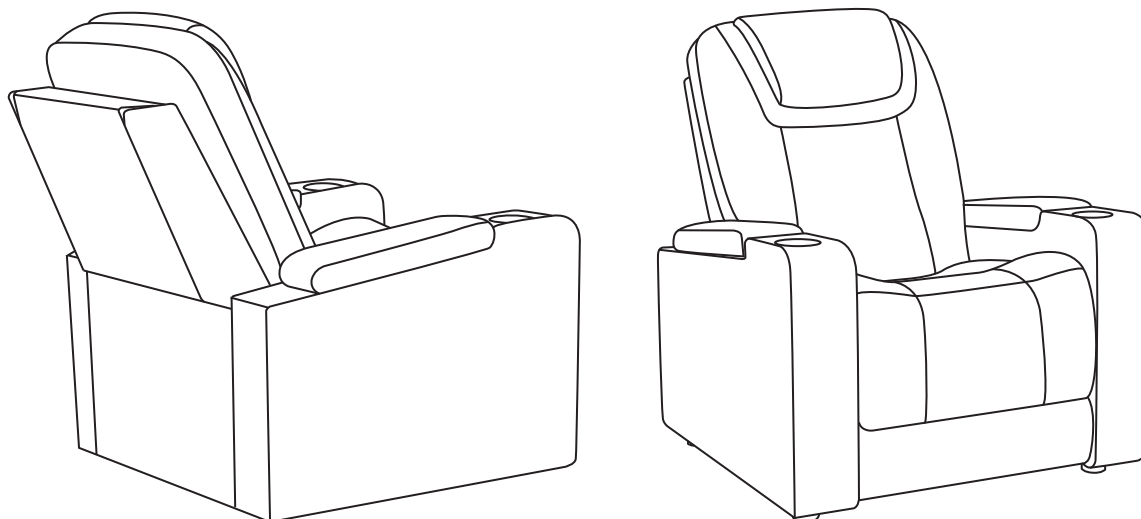

DONE!

Function introductions



**Caution: Read the important instructions below before operating your power mechanized equipment
Do not allow children to play on or operate this power mechanized equipment**

Multi Media Control Panel

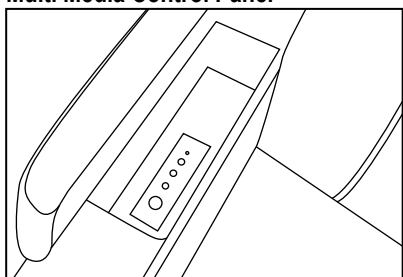

Side Control

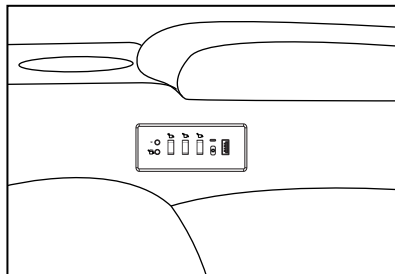

Storage

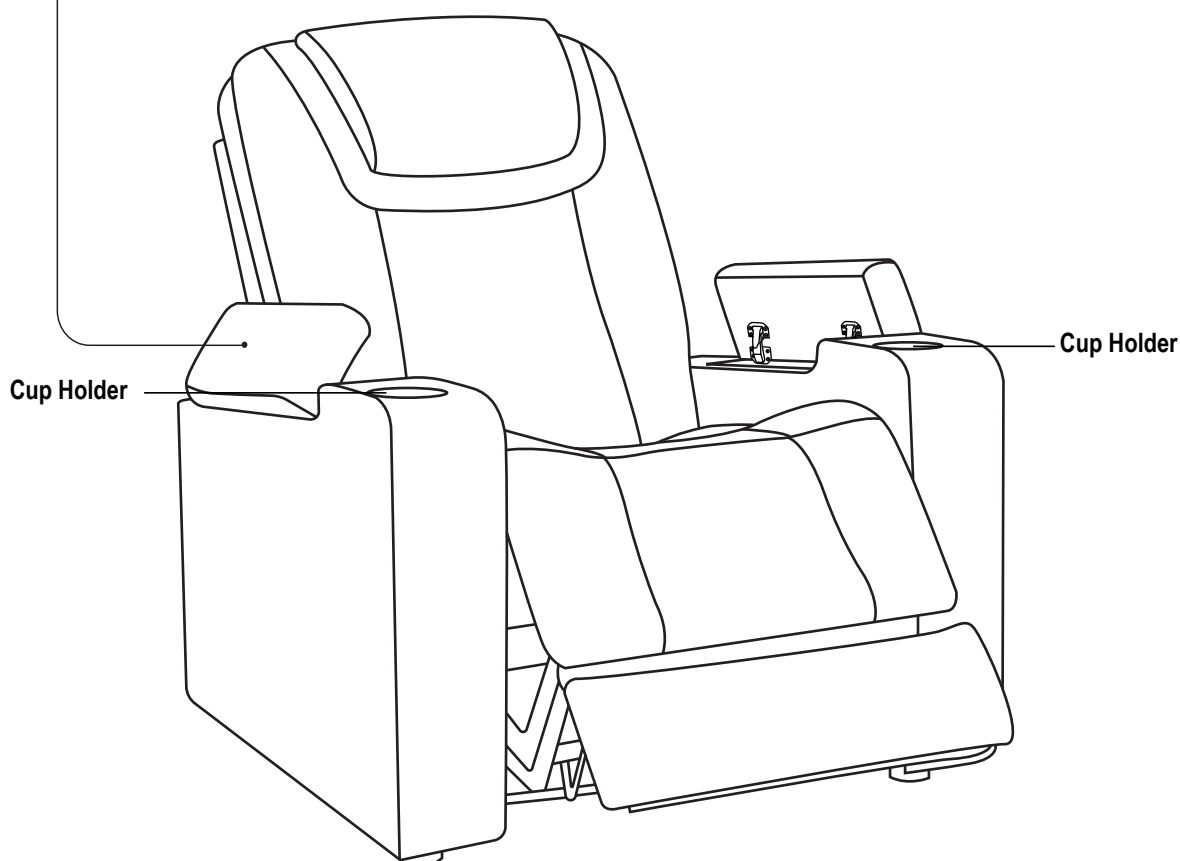
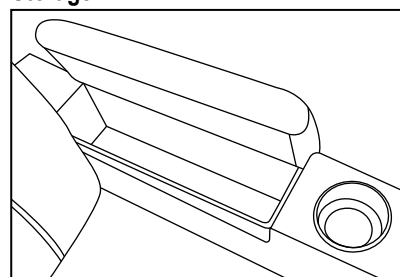

Do Not plug the power cord into a power outlet until your furniture is fully assembled and in place.

Notes:

- 1) To help prevent shock and or damage to your product only plug the power cord into a grounded outlet.
- 2) Read the operating instructions carefully before operating your furniture.

Operating Instructions



SIDE CONTROL

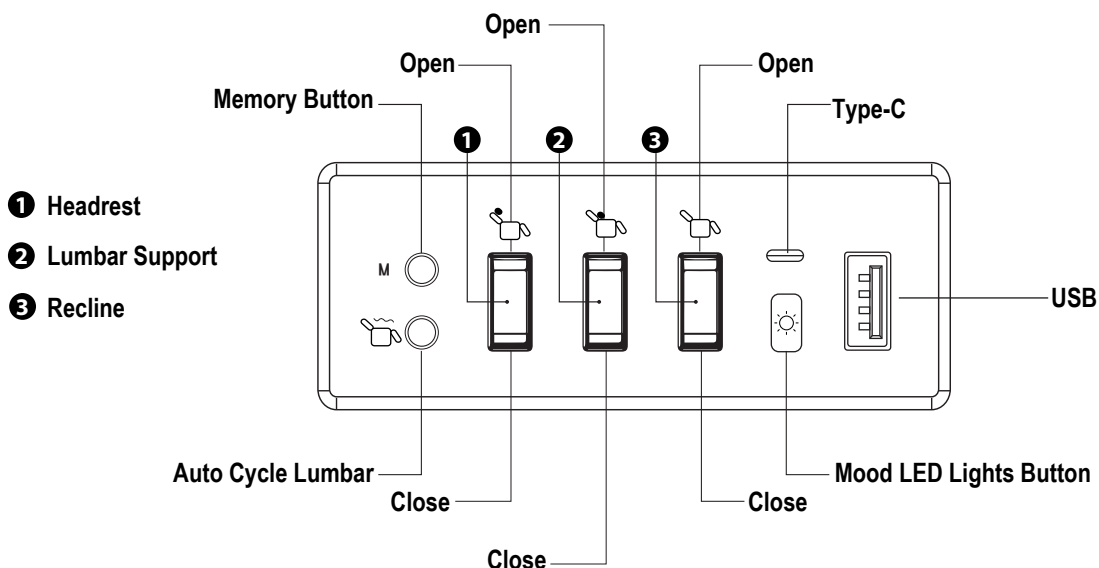

How to use Memory Function

Press and hold Memory Button and Auto Cycle Lumbar Button 3 seconds. The LEDs on the memory buttons will flash to indicate that the hand control is in “set” mode. Press and hold the desired memory button to set the memory position.

The LEDs will stop flashing. To go to a preset memory position, press and hold the desired memory button.

How to use Auto Cycle Lumbar Function

Press and hold 1 second the Auto Cycle Lumbar button to activate the Auto Cycle Lumbar function.

Press and hold 1 second the Auto Cycle Lumbar button again to OFF the Auto Cycle Lumbar function.

How to Use Mood LED Lights

Press the Mood LED Lights buttons to activate the Mood LED function. Press the Mood LED Lights button again to cycle color through 16 colors.

Press and hold 3 seconds to close the LED lights.

Operating Instructions



Multi Media Control Panel

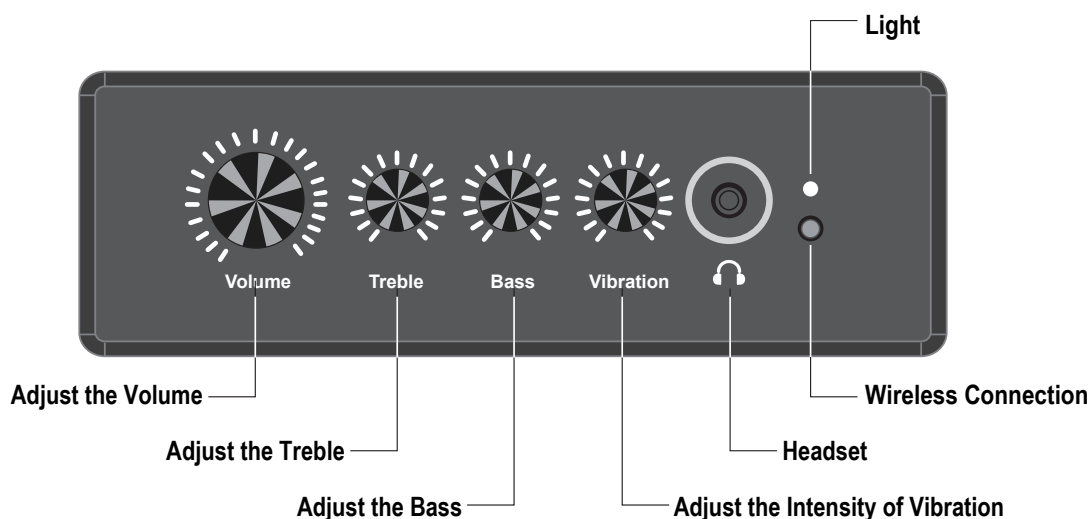

Turning On/Off the Speaker

Press and hold the volume adjustment knob to turn on the speaker. Press and hold again to turn off the speaker.

Wireless Connection Pairing Mode

Press and hold the wireless button (blue light flashes) to initiate pairing. The wireless device name is: Moto Media System. Once connected, the blue light stays on and you will hear a voice prompt: "Connected." If disconnected, the blue light will turn off and you will hear a voice prompt: "Disconnected."

Switching Broadcast Mode

1. Press the wireless button twice quickly; you will hear a voice prompt: "Broadcast mode." When connected, the red light stays on. Press the wireless button twice quickly again, and you will hear a voice prompt: "Broadcast off," which exits broadcast mode.
2. After the device connects via wireless connection, press the wireless button twice quickly (red light flashes) to enter broadcast mode; the blue light will turn purple. Press the wireless button twice quickly again to exit broadcast mode; the purple light will turn back to blue.

Using Broadcast Mode

When a device such as a phone or TV is connected to the wireless connection of Sofa A, press the wireless button twice quickly to switch to broadcast mode (purple light stays on). Then turn on the Sofa B speaker and press the wireless button twice quickly to switch it to broadcast mode (red light stays on). Sofa A will act as the signal source, and Sofa B will sync to play the audio or video from Sofa A.

Operating Instructions



Multi Media Control Panel

Notes

1. Wireless connection search will automatically end after three minutes without connecting to any devices, and the flashing light will turn off. If you press the button during the flashing period, the search will end.
2. Wireless connection mode has higher priority than broadcast mode. In broadcast mode, if different devices connect via wireless connection to play audio or video, broadcast mode will stop. If no playback occurs for about 4 seconds, it will re-search for other broadcast signal sources.
3. If multiple sofas are connected to the same device via wireless connection, audio and video cannot be played simultaneously. The default is for the last connected sofa to play.

Example: If sofas A, B, and C are all in broadcast mode (red light stays on), press and hold the wireless button (red light flashes) to connect to sofa A (purple light stays on). Sofas B and C will sync to play audio or video from sofa A. If the same device connects to sofa B (purple light flashes), sofa B and C will play normally, and sofa A will stop working. If you then connect to sofa C (purple light stays on), sofa C will play normally, while sofas A and B will not work. A restart is needed for playback.
4. When using wireless connection to connect the main speaker sofa to a TV, there may be delays and instability. It is recommended to use a wired connection to the main speaker sofa and then use broadcast mode for wireless synchronization to other sofas.
5. Please keep the wireless connection between devices within 10 meters.

Multimedia Control Box

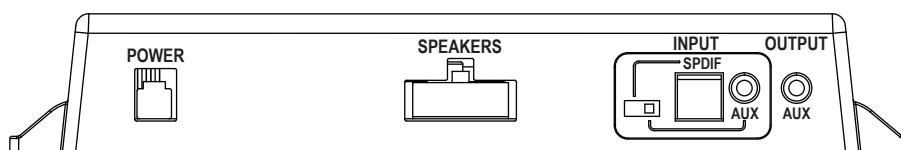

This is located at the bottom of the back of the recliner. AUX input, AUX output, and S/PDIF are located on the Multimedia Control Box. You can connect multiple devices by using a 3.5mm AUX cable connecting the AUX input to the audio source and then connecting another 3.5mm AUX cable from AUX output to the AUX input of the next Multimedia control box. 3.5mm AUX cable sold separately.

Disassembly Instructions



Unzip the seat cushion and back cushion, to remove the back from the base. Pull out the black tab by hand or use a screwdriver pressing outward on black tab, then lift the back from the recliner of the chair to release.

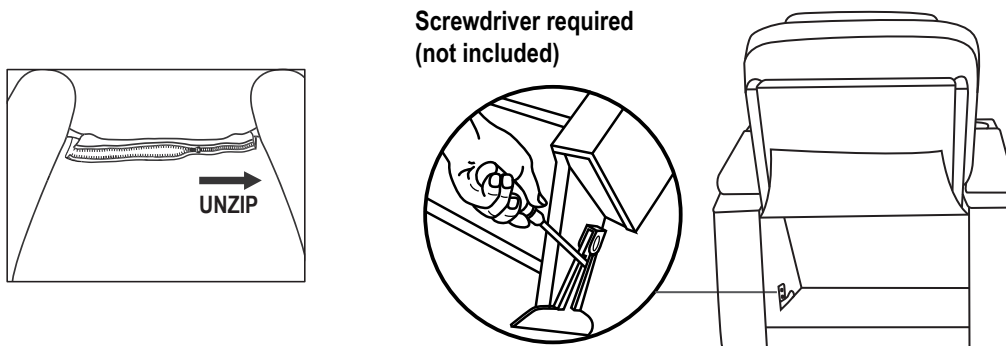

Screwdriver required
(not included)

SERIAL LABEL

Your serial number label is at the rear of the recliner, as the below picture.

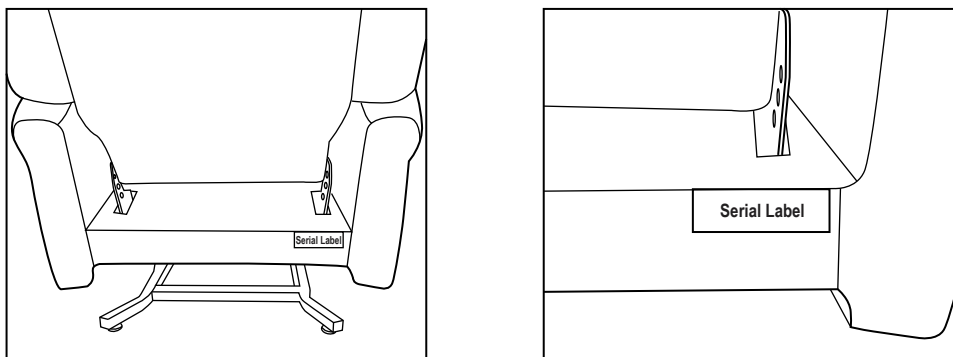

FCC INSTRUCTION

CAUTION: Changes or modifications not expressly approved by the party responsible for compliance could void the user's authority to operate the equipment.

NOTE: This equipment has been tested and found to comply with the limits for a Class B digital device, pursuant to Part 15 of the FCC Rules. These limits are designed to provide reasonable protection against harmful interference in a residential installation. This equipment generates, uses, and can radiate radio frequency energy and, if not installed and used in accordance with the instructions, may cause harmful interference to radio communications. However, there is no guarantee that interference will not occur in a particular installation. If this equipment does cause harmful interference to radio or television reception, which can be determined by turning the equipment off and on, the user is encouraged to try to correct the interference by one more of the following measures:

- Reorient or relocate the receiving antenna.
- Increase the distance between the equipment and receiver.
- Connect the equipment into an outlet on a circuit different from that to which the receiver is connected.
- Consult the dealer or an experienced radio/TV technician for help.

Audio System



PAIRING INSTRUCTION

Before you start. Switch on the pairing function on your mobile device. Make sure your power foundation is correctly connected and is power-on.

1. Pair with Audio System: Search for the audio device named "Moto Audio" on your device and establish a connection.
2. Music Playback: Once your devices are successfully connected, you can begin playing music through the audio system integrated into the power foundation.
3. Connection Range: Keep in mind that the effective range between the power foundation and your device is approximately 26 ft.

TROUBLESHOOTING

SYMPTOMS	SOLUTIONS
No sound	The volume is on minimum.
	Audio system is not paired properly.
	Please contact the store or customer service.
Audio system cannot be paired	Restart your power foundation.
	Do not attempt to pair the device behind a wall.
	Make sure you are pairing the devices within the connection range (26 ft).

PRODUCT PROTECTED BY FOLLOWING PATENTS:
Patented Articulating Power Headrest & Lumbar
US Patent: 10, 736, 423

00976B

Customer Service Toll Free: 1-844-696-6886

Email: motoservice@hcusacorp.com



LIVING SPACES

Thank you for purchasing a Power Foundation.

Contact Customer Service Toll Free at

1-844-696-6886

Email: motoservice@hncusacorp.com

Immersive Entertainment System with Sync Technology



Congratulations on your new MotoMotion Immersive Entertainment Product(s)!

You can connect to your audio source in **4** ways:



Wireless (Bluetooth)

Easily connect at the press of a button.

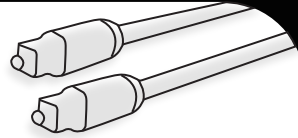

SPDIF Digital Optical Cable

(sold separately)

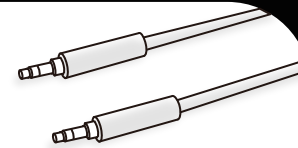

3.5 mm Auxiliary Audio Cable

(sold separately)

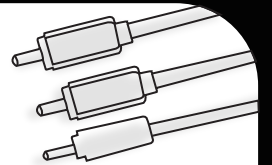

RCA to 3.5 mm Auxiliary Audio Cable

(sold separately)

Though this product can be wirelessly connected to your audio source, if you would like to connect using cables, please ensure you have the necessary cables prior to your product arriving. A convenient cable kit is available for purchase at MotoMotion.



THIS IMMERSIVE AUDIO SETUP LITERATURE IS THE EXCLUSIVE PROPERTY OF MOTOMOTION AND IS PROTECTED UNDER RELATED COPYRIGHT LAWS AND REGULATIONS.

Contents

Get to Know Your Immersive Entertainment System	1
Our Patented Immersive Entertainment Components	2
Audio Source	3
Introducing Moto Sync Technology	4
Setup with Wireless (Bluetooth) Connection	7
Setup with SPDIF Digital Optical Cable(s)	9
Setup with 3.5mm Auxiliary Audio Cable(s)	11
Setup with RCA Audio Cable(s)	13
Appendix	15
Troubleshooting Guide Table	19

Get to Know Your Immersive Entertainment System

Important: The amplifier can be in different places depending on the product.

Here are some common locations:

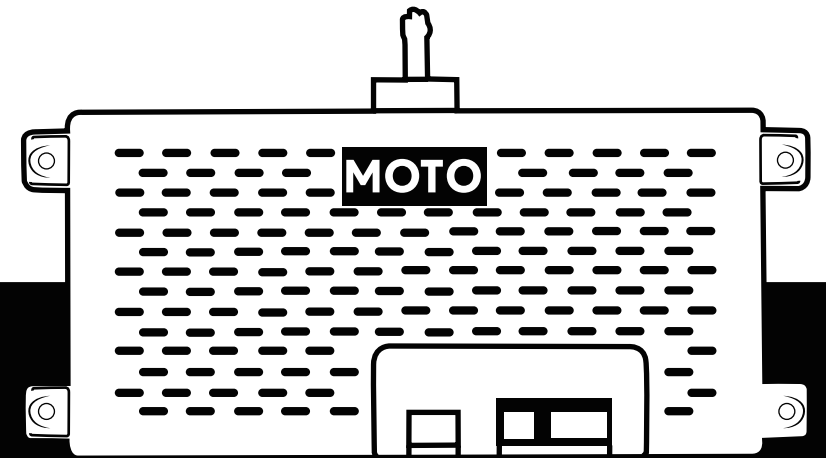

Moto Media Amplifier

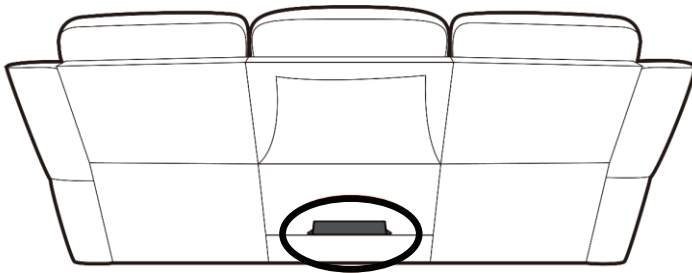

Sofa

Located behind the back flap of the middle seat.

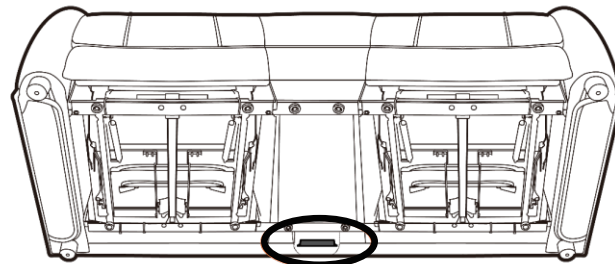

Console Loveseat

Located inside the console, accessible from the bottom via a zipper.

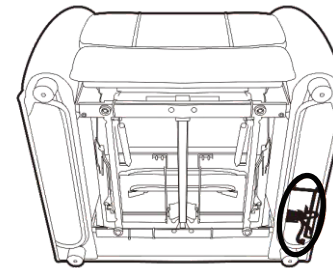

Recliner

Located inside either arm, accessible from the bottom via a zipper.

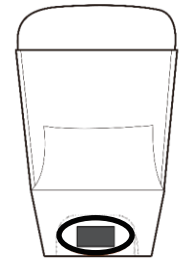

Console

Located inside the console, accessible from the bottom via a zipper.

Our Patented Immersive Entertainment Components

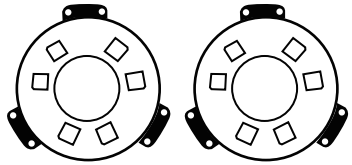

Feel the sound come alive with tactile transducers!

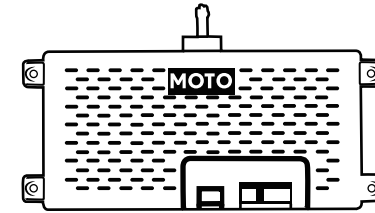
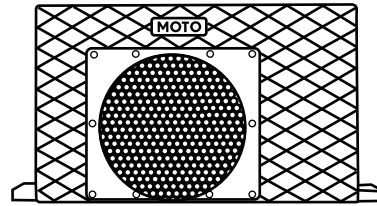
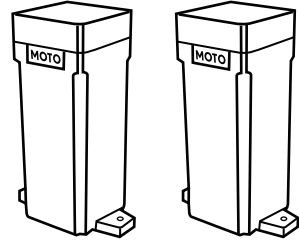

Transducers

These are built into the seat and back of the recliners, syncing perfectly with the audio to boost your entertainment experience.

Full Range Speakers

Bring your movies, music, or video games to life.

Subwoofer

Our mighty subwoofer delivers the perfect punch of bass without bothering the neighbors.

Moto Media Amplifier

The 100-watt amplifier gives you all the power you need, no matter what you're watching or listening to.

Moto Media Controller

The stylish modern controller lets you adjust volume, treble, bass, and vibration separately. It also features pairing, broadcasting, and a headphone jack.

Audio Source

It's important to know each device like a TV, gaming system, or tablet connects audio to other equipment in different ways, such as **Bluetooth, SPDIF Digital Optical, 3.5mm Auxiliary, or RCA outputs.**

Make sure to check your **audio output options** on your device before delivery. Refer to following pages for different connection options.

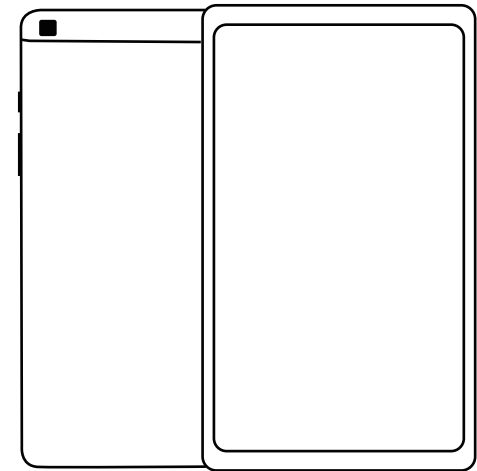
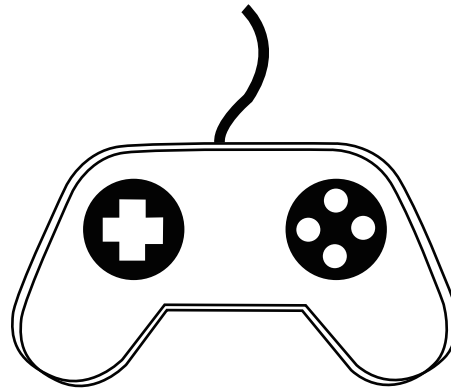
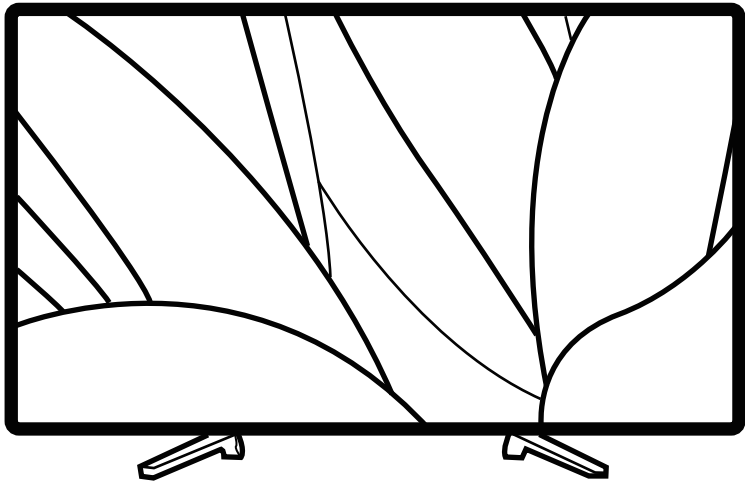

Introducing Moto Sync Technology

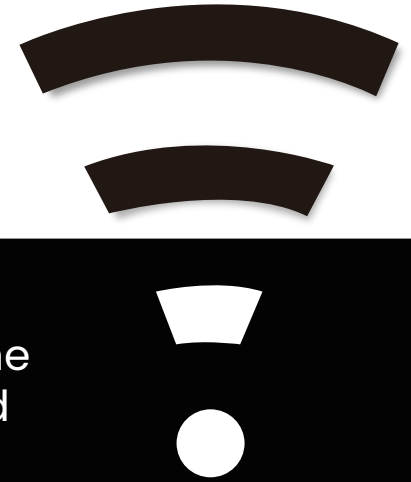

Experience seamless audio with Moto Sync Technology. This innovative feature wirelessly broadcasts audio signals between all MotoMotion Entertainment product(s) equipped with the technology in the closeby area, eliminating the need for cables. Enjoy a clutter-free setup and immersive sound throughout your space.

It is suggested that one piece of your Immersive Entertainment products is connected by a cable to the audio source and then connect all other Immersive Entertainment products to the cabled/connected piece by Bluetooth.

How to Identify if Your MotoMotion Immersive Entertainment Product Has Moto Sync Technology:

- Check for the Moto Sync label on your Moto Immersive Amplifier.
- Refer to the owner's manual of your product.

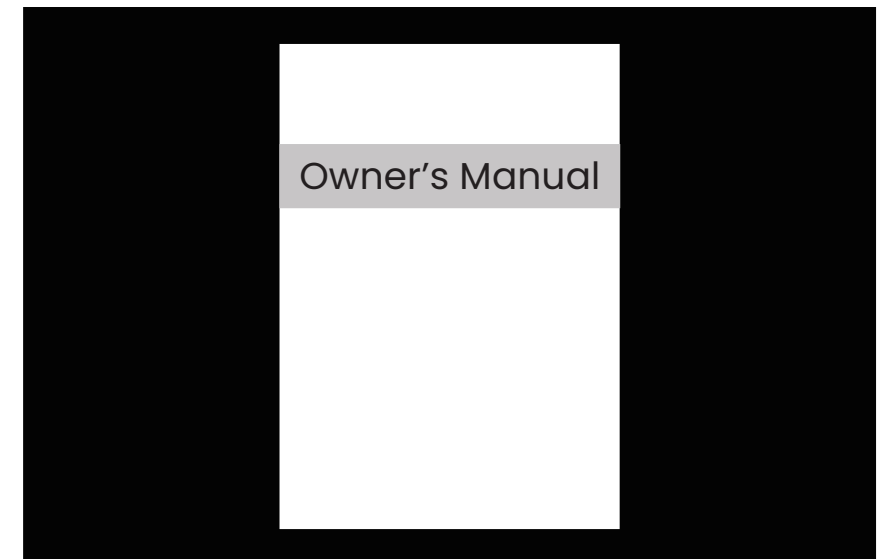
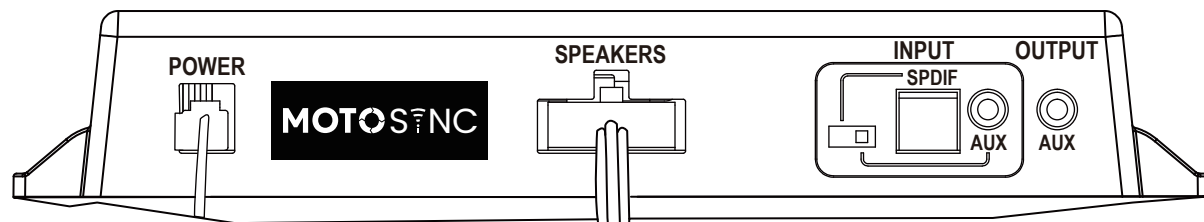

Introducing Moto Sync Technology

To activate or deactivate Broadcast Mode, double tap the **pairing button**; The system will announce "Broadcast On" or "Broadcast Off" to indicate the current status.

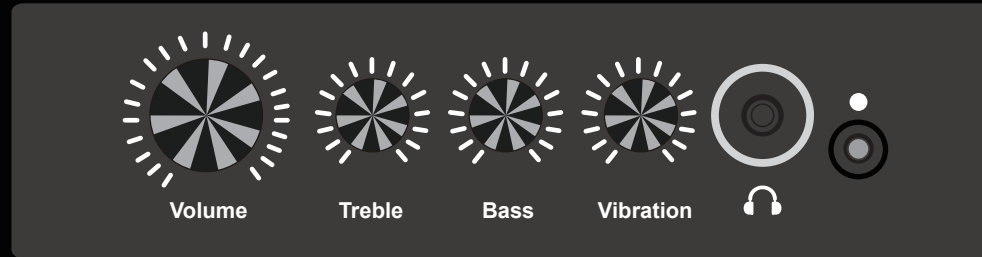

LED Indicator	Broadcast Mode	System Status
○ Light Off	Off	Broadcast Off / System not paired to any Bluetooth device
☀ Blue Light Flashing	Off	Broadcast Off / System in Bluetooth pairing mode
● Blue Light	Off	Broadcast Off / System is paired to a Bluetooth device
● Red Light	On	Broadcast On / System not paired to any Bluetooth device
☀ Red Light Flashing	On	Broadcast On / System in Bluetooth pairing mode
● Purple Light	On	Broadcast On / System is paired to a Bluetooth device

Introducing MOTO Sync Technology

Diagram of Different Connections

Wireless

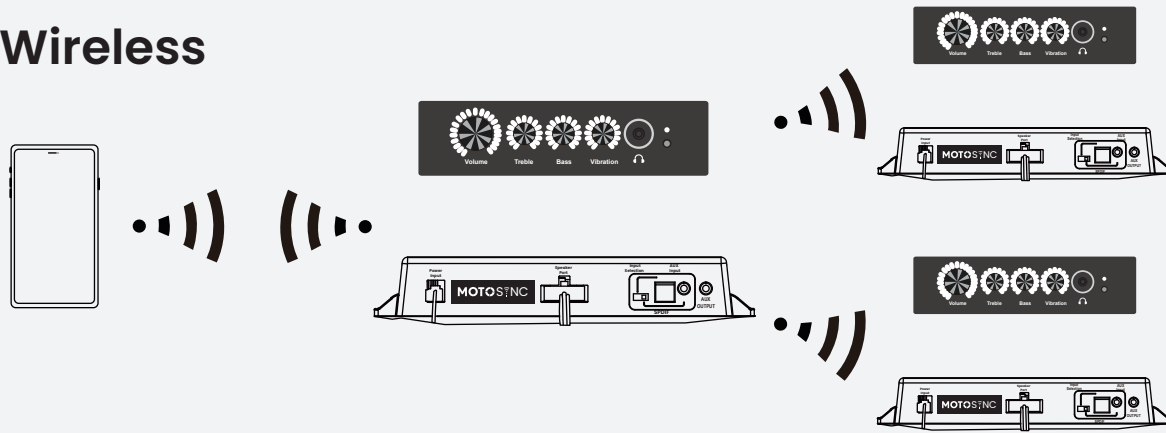

SPDIF

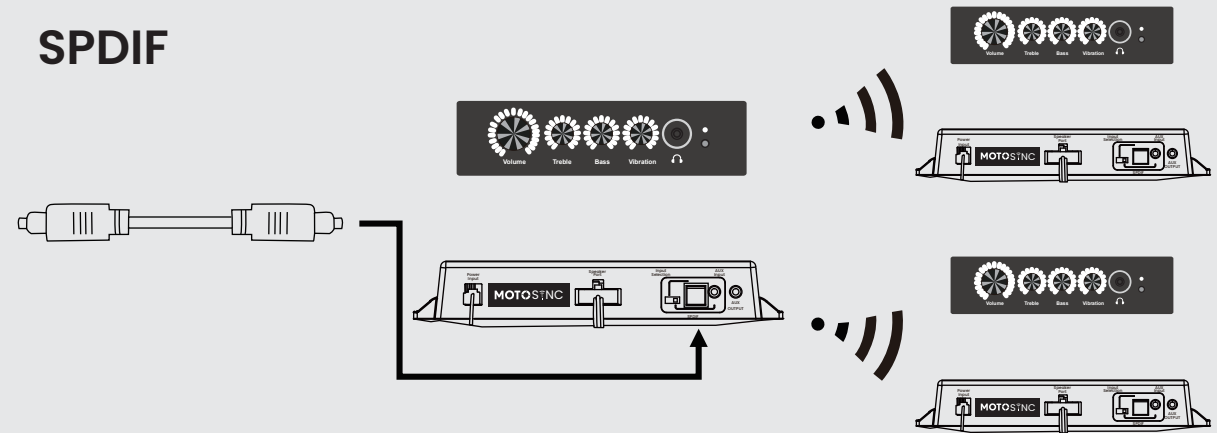

AUX

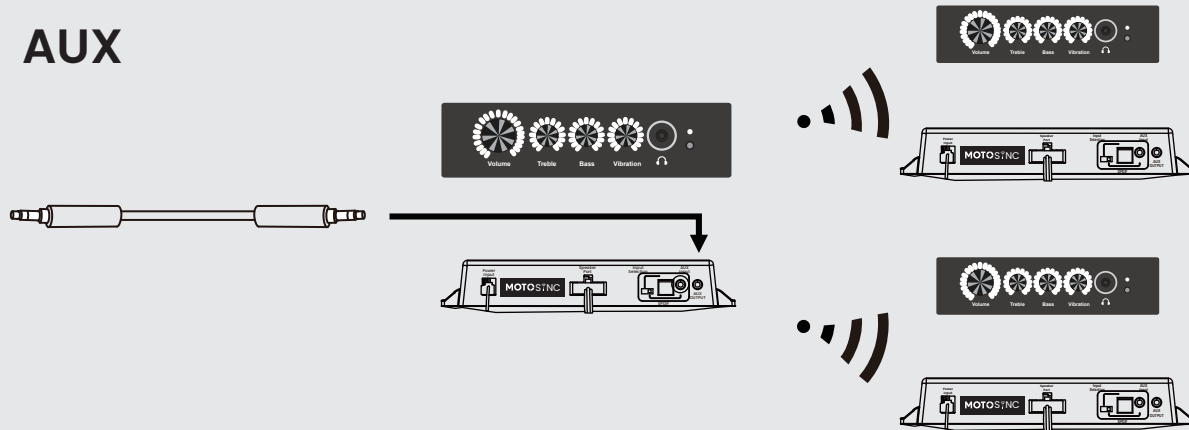

RCA-AUX

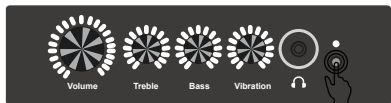
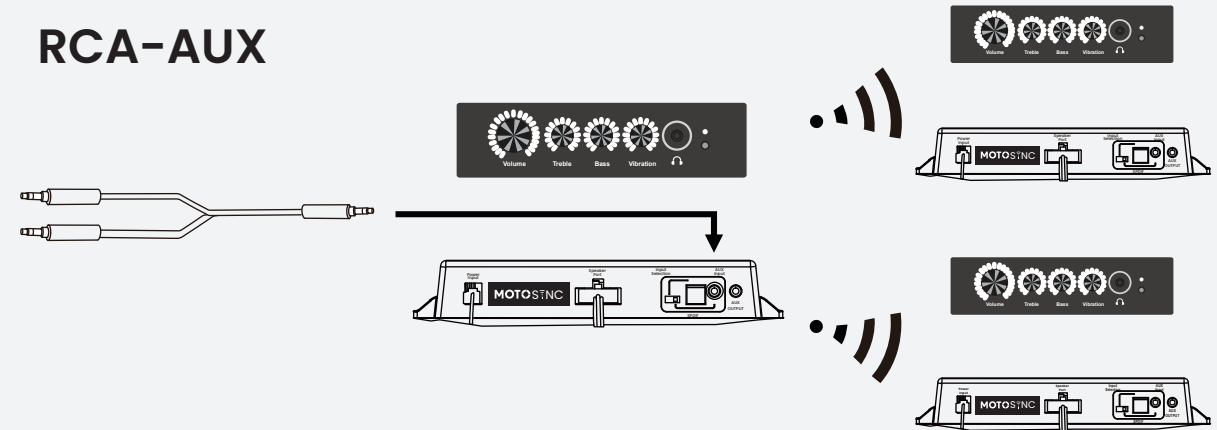

- ❑ Establish connection to the audio source with one piece of furniture in one of connection options, then simply double tap the wireless pairing button on that piece to initiate "broadcast mode".
- ❑ Next, go to each of the other pieces and only double tap the pairing button to receive the established connection.

Setup with Wireless (Bluetooth) Connection

1 Switch your Moto Immersive Amplifier to AUX mode.

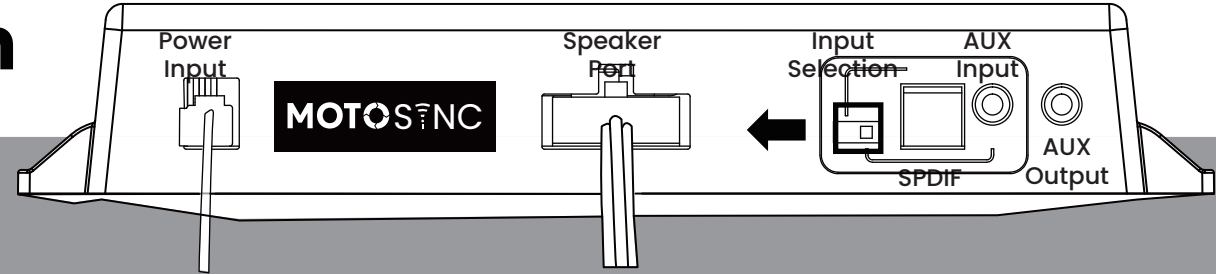

2 Locate the audio control panel on your MotoMotion entertainment product(s).

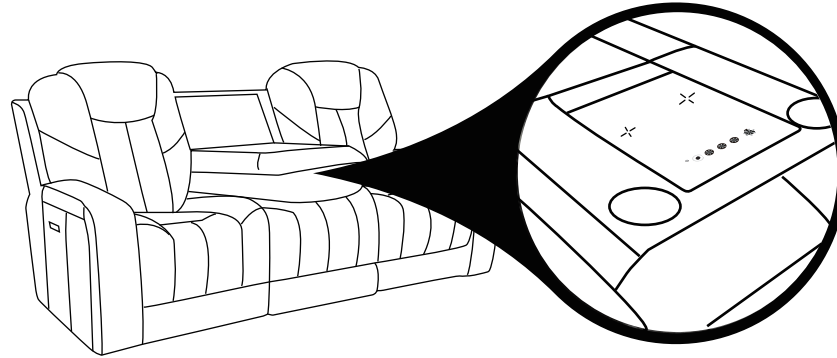

Sofa Drop Down Table

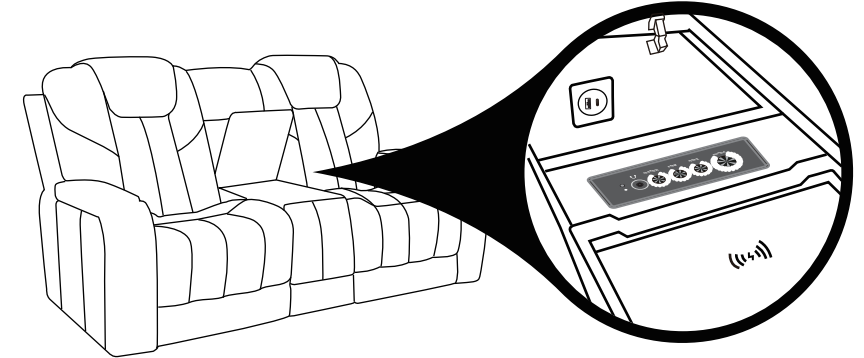

Loveseat Inside the Console

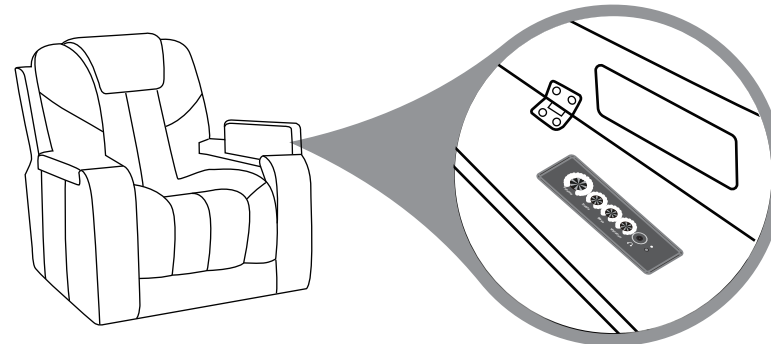

Recliner Inside the Arm Storage

or

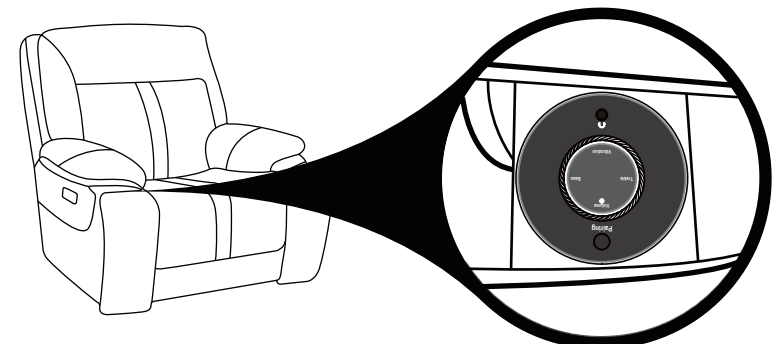

Setup with Wireless (Bluetooth) Connection

3 Turn on Bluetooth on the device you want to connect.

4 Hold the **pairing button** on the audio panel for 5 seconds until the blue light blinks.

5 Find “Moto Media System” on your device (phone, tablet, TV, etc.) and select it to pair with the sound system.

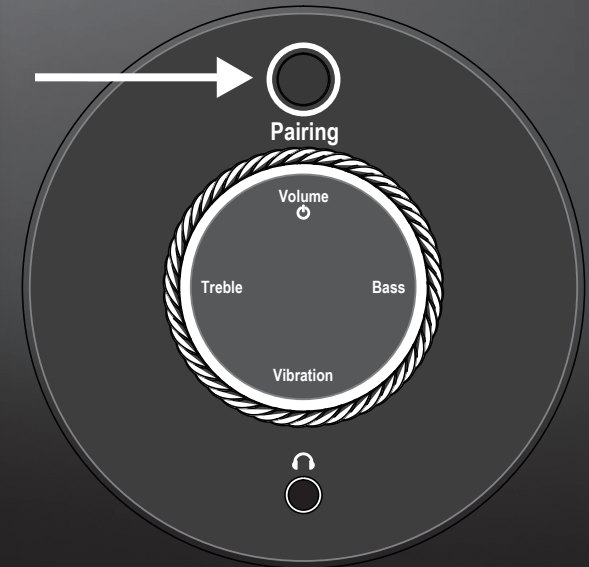
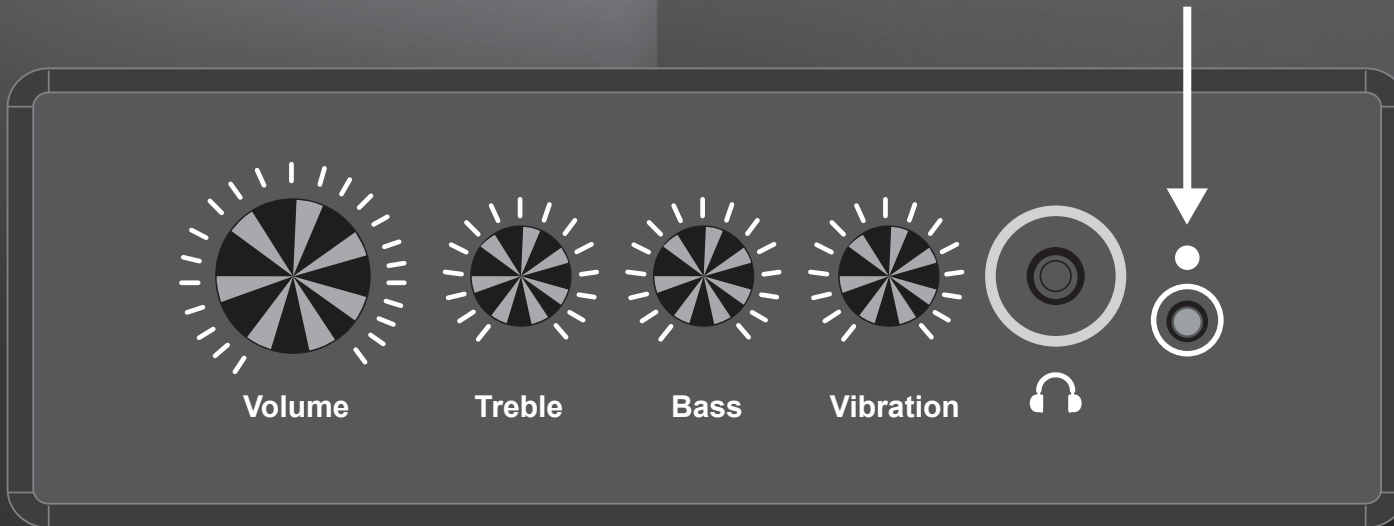

Note: If using an Aux cord or Digital cable, the wireless function will connect but won't play sound.

Setup with SPDIF Digital Optical Cable(s)

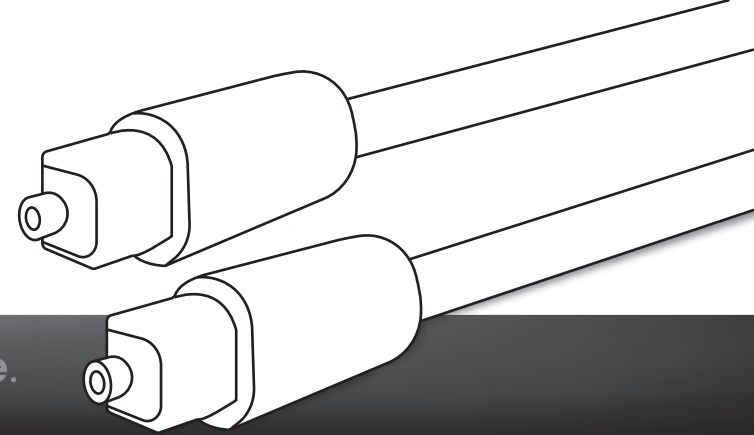

To get the best audio performance, setup your system with a **digital optical cable**. Each MotoMotion amplifier has one SPDIF Digital Optical Input Port.

- 1 Prepare the connection cable(s) and the digital optical splitter.

The cable(s) you need for this setup is **NOT** included with your MotoMotion Immersive product(s) and can be purchased in a kit provided by MotoMotion.

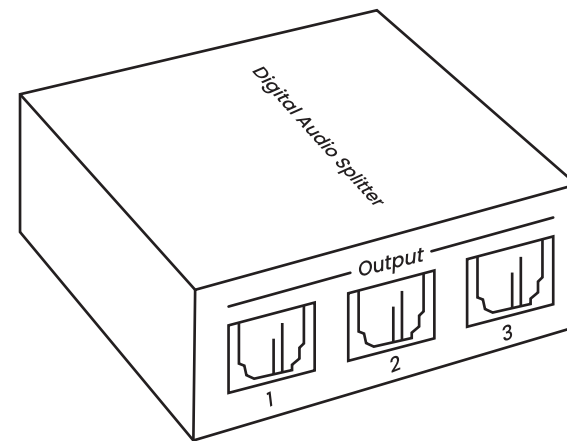

- 2 Switch your Moto Immersive Amplifier to SPDIF mode.

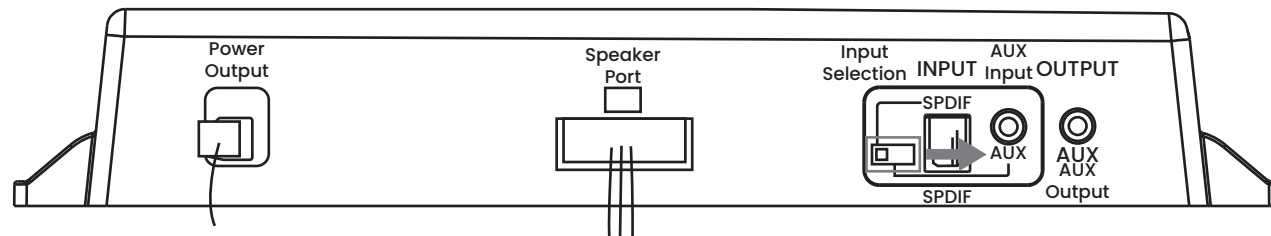

Setup with SPDIF Digital Optical Cable(s)

3 To set up a single MotoMotion Immersive product with your audio source, connect the digital optical cable to the SPDIF input port on your MotoMotion Immersive Amplifier. Then, connect the other end of the cable to the SPDIF output port on your audio source.

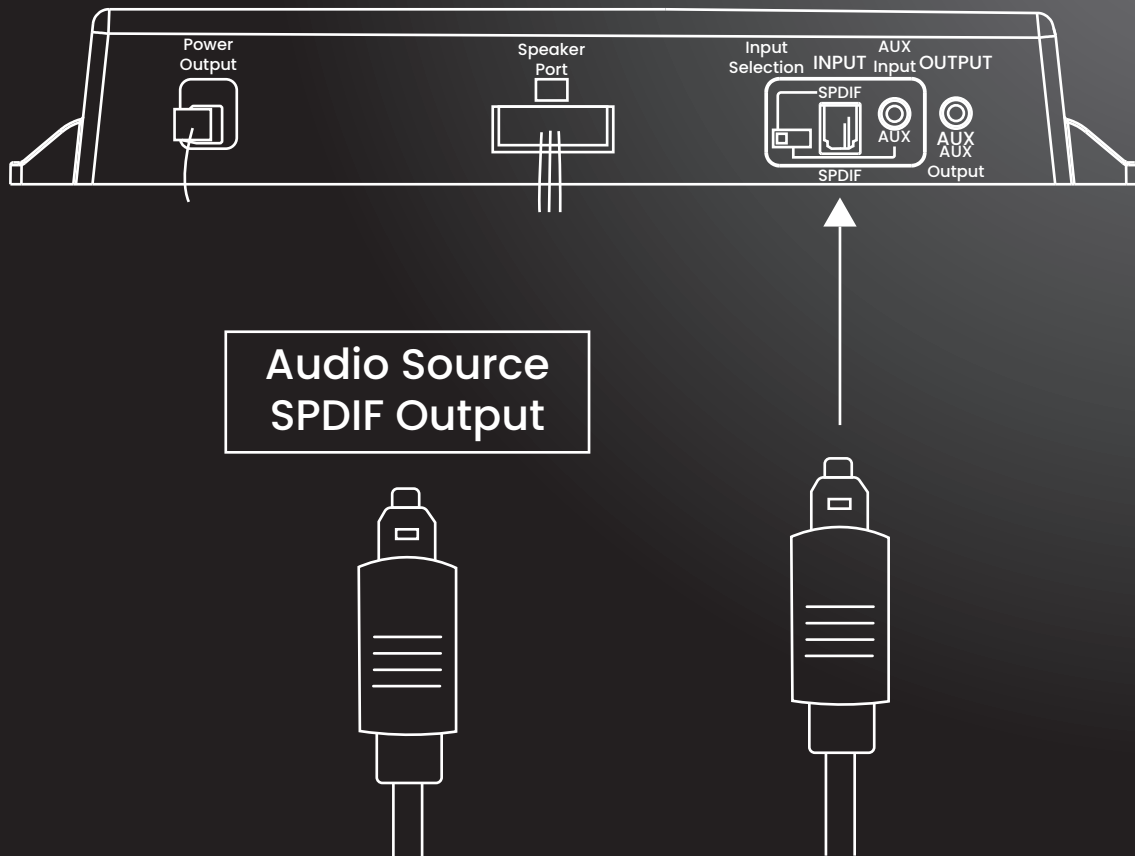

4 If you want to connect multiple MotoMotion Immersive product(s) using SPDIF digital optical cables, you need to buy a digital optical splitter. Connect the digital optical splitter to your audio source and then run separate optical cables to each unit.

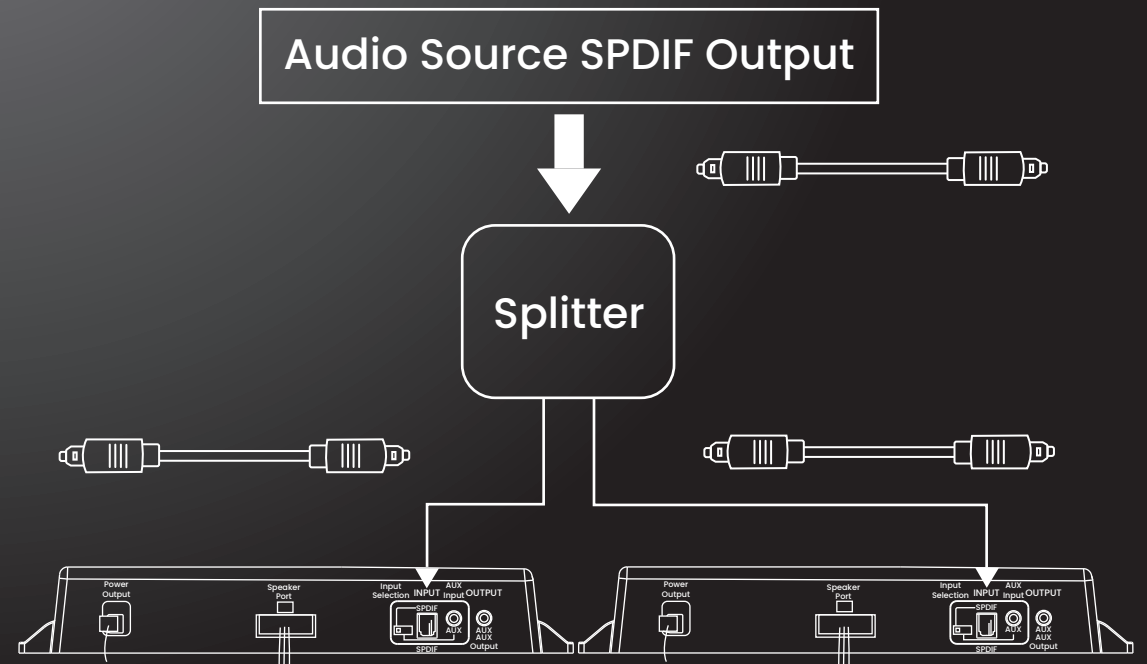

Setup with 3.5mm Auxiliary Audio Cable(s)

Connecting your audio devices is a breeze with 3.5mm auxiliary cables as this is the most common parts for audio connections. If your device has a 3.5mm output port, you're all set — no extra hardware needed. Each MotoMotion amplifier comes equipped with both AUX IN and OUT ports, making it easy to handle both audio input and output.

- 1 The cable(s) you need for this setup is **NOT** included with your MotoMotion Immersive product(s) and can be purchased in a kit provided by MotoMotion.

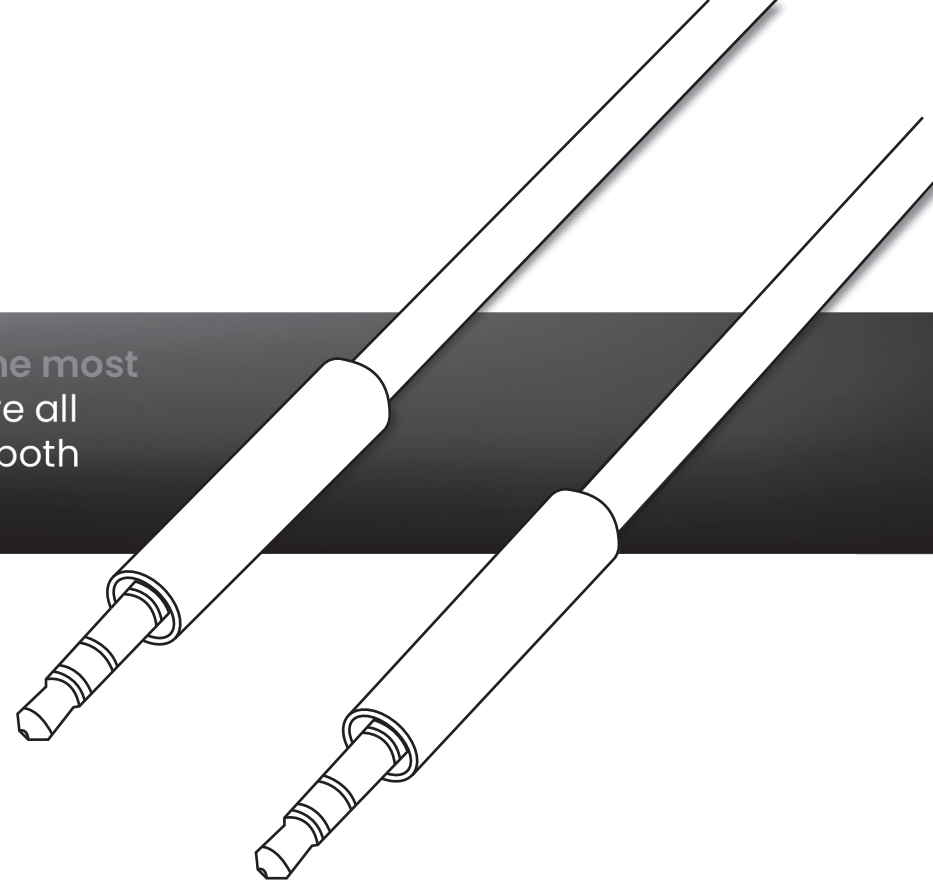

- 2 Switch your Moto Immersive Amplifier to AUX mode.

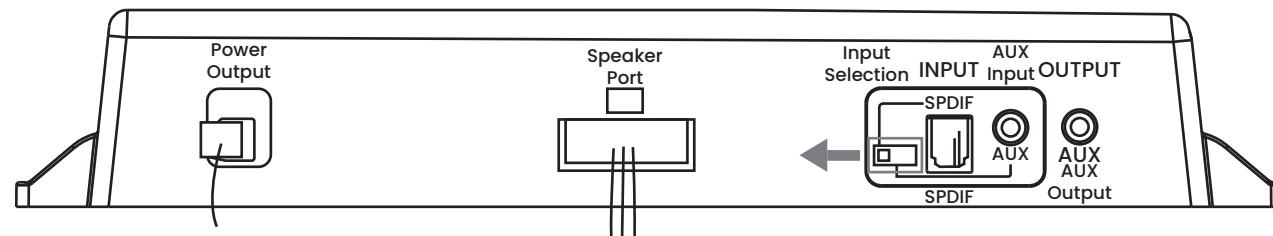

Setup with 3.5mm Auxiliary Audio Cable(s)

3 To set up a single MotoMotion Immersive product with your audio source, connect the 3.5mm auxiliary audio cable to the AUX input port on your MotoMotion Immersive Amplifier. Then, connect the other end of the cable to the AUX output port on your audio source.

4 If you want to connect multiple MotoMotion Immersive product(s) using 3.5mm auxiliary audio cables, you can easily daisy chain them. Just plug a second 3.5mm auxiliary cable into the AUX output port of the first MotoMotion product and then into the AUX input port of the next one.

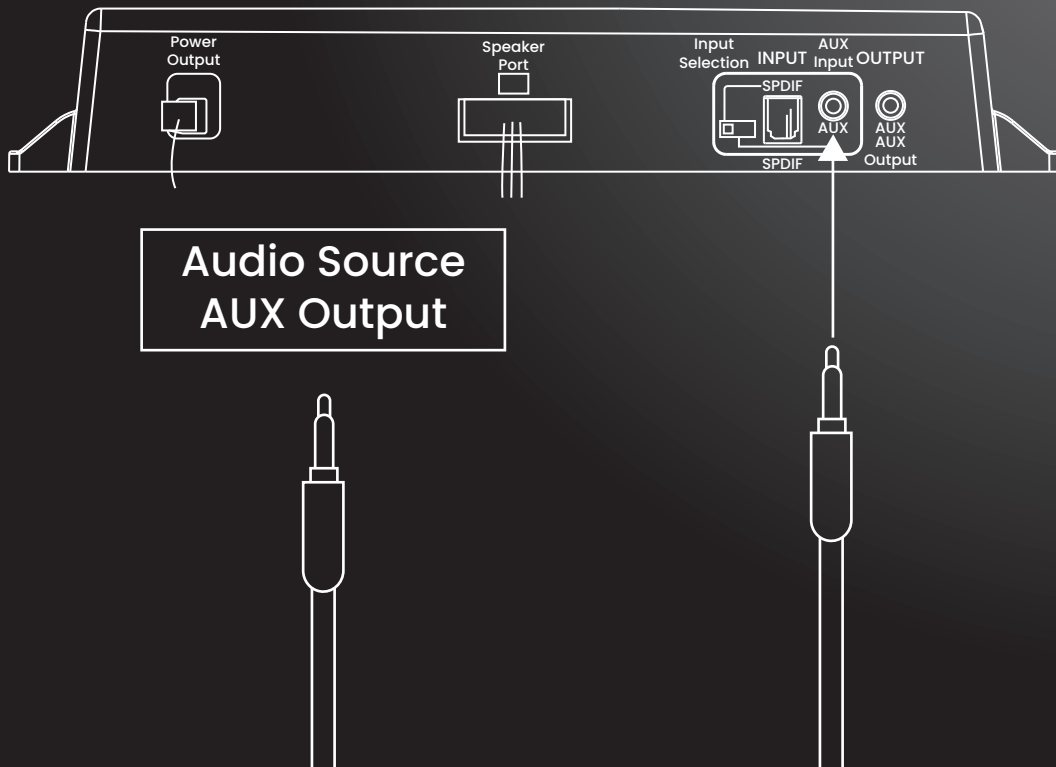

*Daisy Chain:
Refer to appendix
on page 15

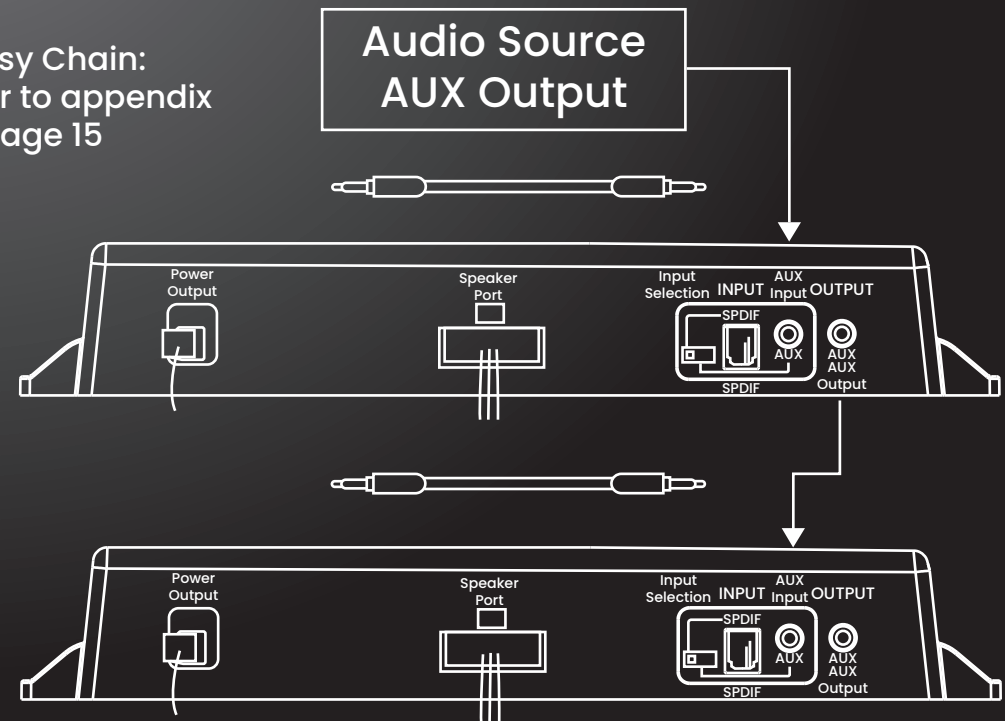

Setup with RCA Audio Cable(s)

If you want to use the **RCA (red and white) output** from your audio source, you'll need to buy an RCA to 3.5mm AUX adapter cable before your MotoMotion Immersive product(s) arrives.

- 1 The necessary cables for this setup are **NOT** included with your MotoMotion Immersive product and can be purchased in a kit provided by MotoMotion.

- 2 Switch your Moto Immersive Amplifier to AUX mode.

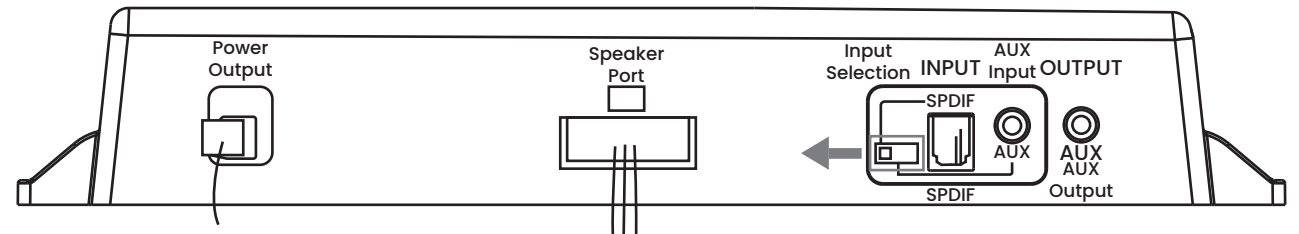
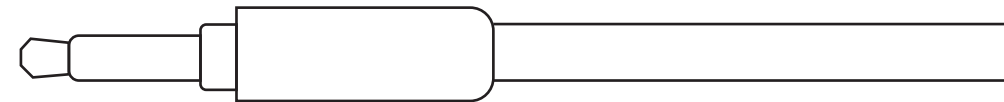
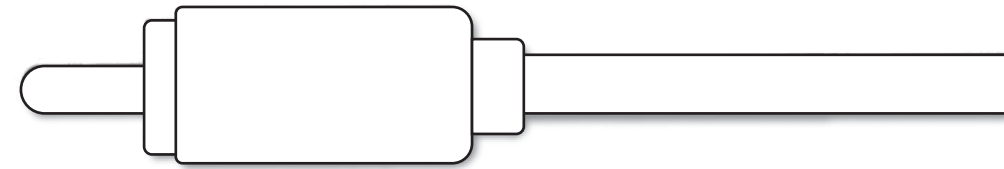
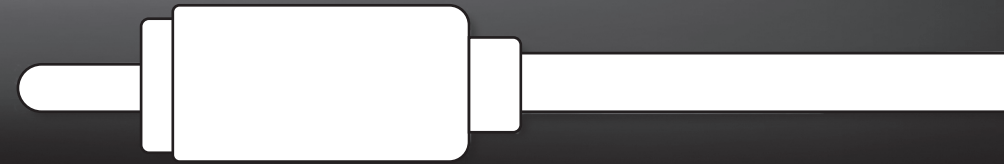

Setup with RCA Audio Cable(s)

- 3** To set up a single MotoMotion Immersive product with your audio source:
- Plug one end of the 3.5mm auxiliary audio cable into the AUX input port on your MotoMotion Immersive Amplifier.
 - Attach the RCA end of the adapter cable to the RCA output ports on your audio source.

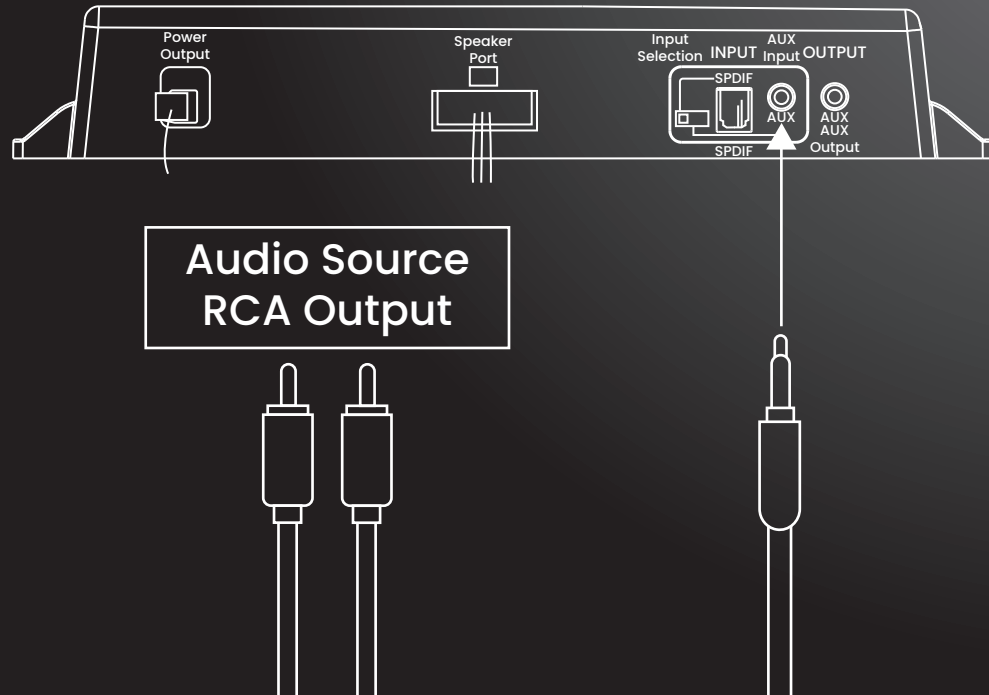

- 4** To connect multiple MotoMotion Immersive products, first connect the RCA to 3.5mm AUX adapter to your audio source. Then, plug the 3.5mm auxiliary cable into the AUX input port on the first product. Next, plug a second 3.5mm auxiliary cable into the AUX output port of the first product and into the AUX input port of the next one.

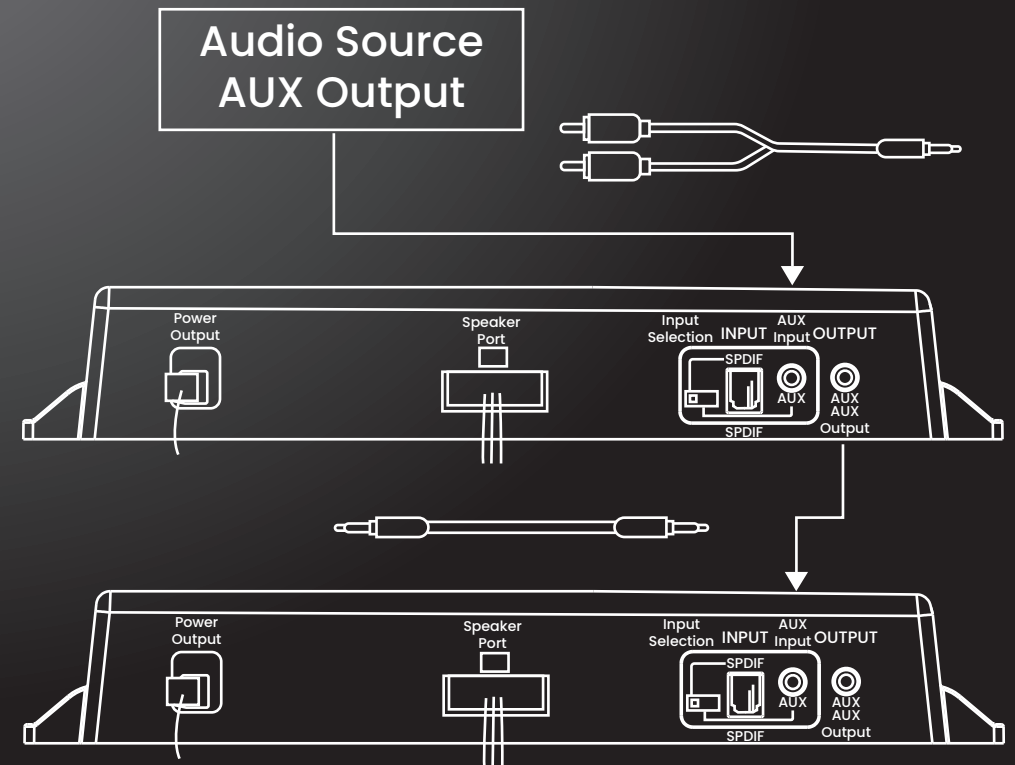

Appendix

Terminology – Daisy Chain

Daisy Chain refers to the configuration where large-scale devices are connected in a series. In this context, it means linking each MotoMotion product sequentially to the next.

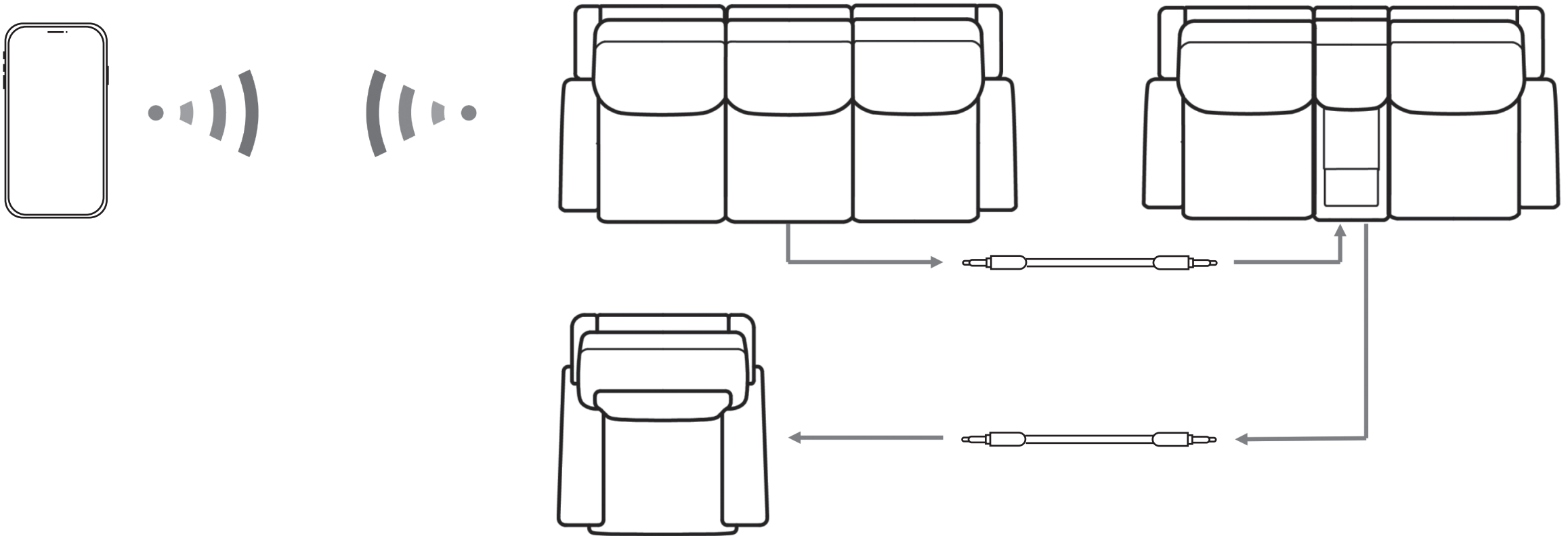

Troubleshooting Guide Table

PROBLEM	SOLUTION
My furniture won't connect to my TV wirelessly.	First, check your TV's owner's manual to confirm that it supports Bluetooth speaker connections. Ensure your furniture is powered on, not currently connected to another device, and refer to the connection guide for pairing instructions.
I am connected/paired to my TV but I am not getting any sound out of the furniture.	If connected wirelessly, ensure your TV's audio output is set correctly (Wireless Audio output for example). Additionally, use your TV remote to increase the master volume to a high level (near maximum).
I am hard wired to my furniture with either an S/PDIF Optical cable or a 3.5mm AUX cord but not getting sound.	A small switch on the amplifier must be set to the correct position, corresponding to the type of wired connection you are using. Refer to the connection guide to ensure the input selection switch is in the appropriate setting.
I bought multiple pieces of furniture. Only one is connected to my TV as an audio source (via Bluetooth-enabled TV, 3.5mm AUX, or S/PDIF Optical). How do I synchronize them?	Use the "broadcast mode" feature on your furniture. To activate broadcast mode, quickly double-tap the pairing button (do not press and hold). This will allow the signal to be shared. Next, quickly double-tap the pairing button on each additional piece. Refer to the connection guide for more details and images.

Troubleshooting Guide Table

PROBLEM	SOLUTION
My furniture's audio system won't turn on at all.	First, ensure all necessary power supplies are plugged into a working outlet and receiving power. Next, you must press and hold the designated power symbol. Activate it by either pressing the main volume knob on the audio control panel or the power/volume area on the circular ring audio control (found on recliners).
I purchased a sectional and have the console beside the recliner on the right side when I am facing the sectional. Not all of my speakers and vibration are working.	When placing the console beside the right-arm-facing recliner, two audio wires inside the console must first be reversed. Next, reverse the corresponding wires on the remaining pieces to ensure the male and female connectors match correctly across the rest of the pieces.
How far will the Bluetooth-enabled connection reach?	Approximately 30 feet (10 meters). This range also applies to pieces using the broadcast mode feature.
I have one piece connected via optical cord and I want to daisy chain the rest with a 3.5mm AUX cord.	This is not possible. The signal cannot be transmitted simultaneously via both optical and AUX connections. You will need to either go all AUX to utilize the AUX IN/AUX OUT, or purchase an optical splitter with enough outputs for the number of connections you require.

Troubleshooting Guide Table

PROBLEM	SOLUTION
<p>My furniture won't work with my existing sound bar or surround sound system.</p>	<p>It is possible to synchronize the furniture with your existing setup, however, this requires purchasing additional after-market components. For example, a sound bar connected via optical cable will need to have the optical signal split, with one end going into your sound bar and the other going to your furniture. The method of integration is entirely up to you, as all systems are different. We suggest connecting the furniture as a separate system and referring to your TV's settings (consult the owner's manual) to switch between audio outputs.</p>

Immersive Entertainment System

MOTO
MOTION
FASHION • FORWARD • FURNITURE



www.motomotionfurniture.com