

5

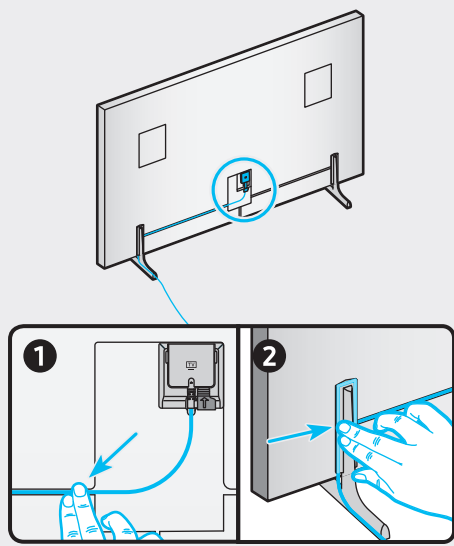

6

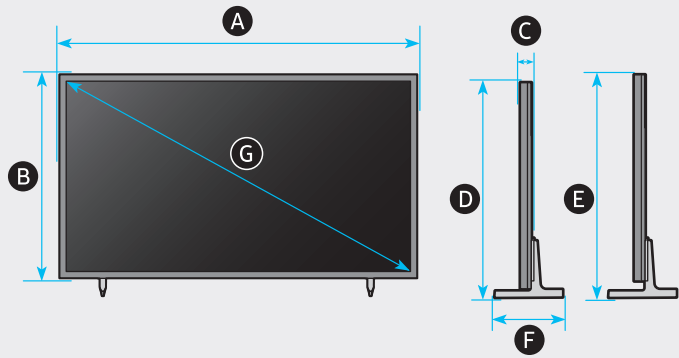
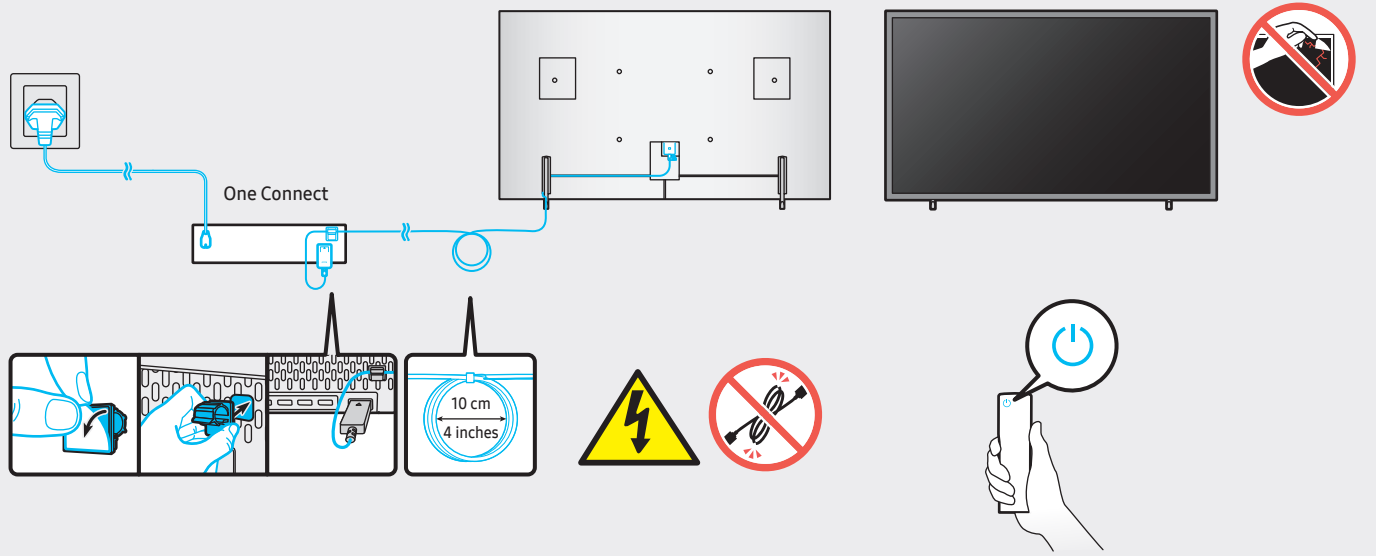

	A	B	C	D	E	F	G	H	I
QN43LS03A	38.2 inches (969.5 mm)	22.0 inches (557.8 mm)	1.0 inches (24.9 mm)	23.3 inches (591.9 mm)	24.3 inches (616.9 mm)	7.7 inches (196.8 mm)	42.5 inches	19.0 lbs (8.6 kg)	19.6 lbs (8.9 kg)
QN50LS03A	44.3 inches (1124.1 mm)	25.4 inches (644.9 mm)	1.0 inches (24.9 mm)	26.7 inches (679.2 mm)	27.7 inches (704.2 mm)	9.0 inches (227.8 mm)	49.5 inches	26.0 lbs (11.8 kg)	26.9 lbs (12.2 kg)

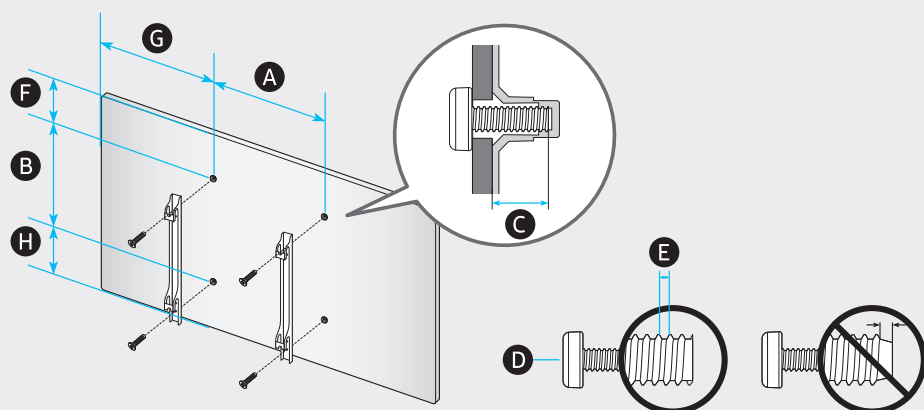
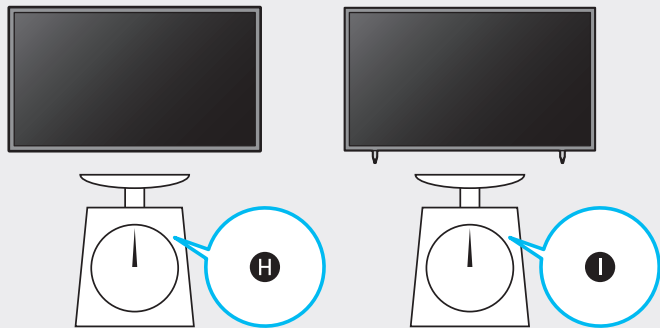

	VESA A x B (mm)	C (mm)	D x 4	E (mm)	F (inches)	G (inches)	H (inches)
QN43LS03A	200 x 200	9-11	M8	1.25	7.6	15.1	6.5
QN50LS03A		10-12			8.3	18.2	9.2

SAMSUNG

QUICK SETUP GUIDE



Scan this QR code with your smart phone to see helpful videos.

43"

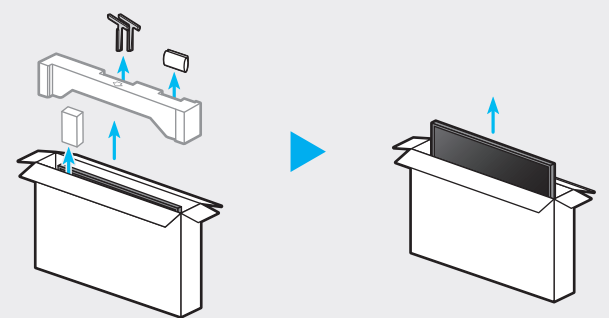

50"

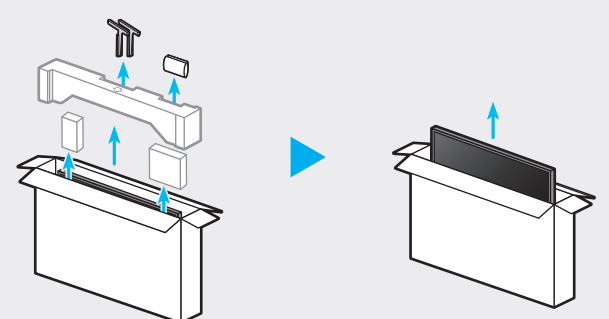

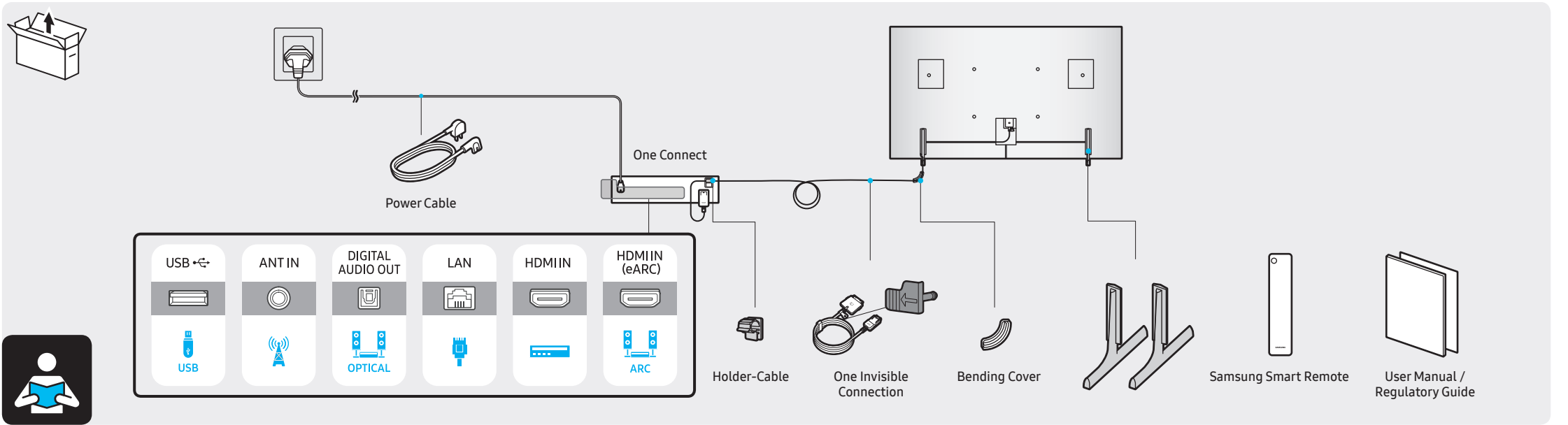

1

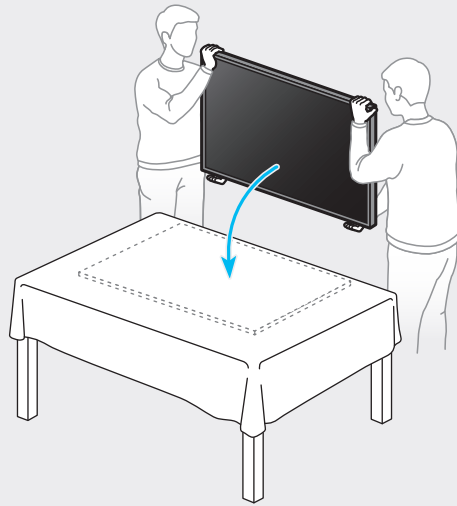

2

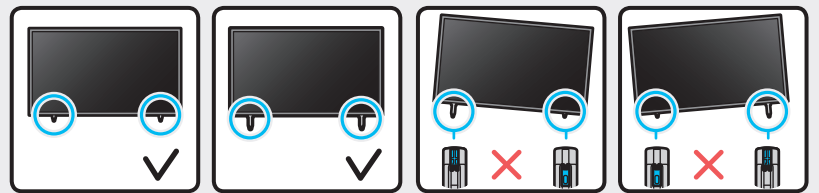
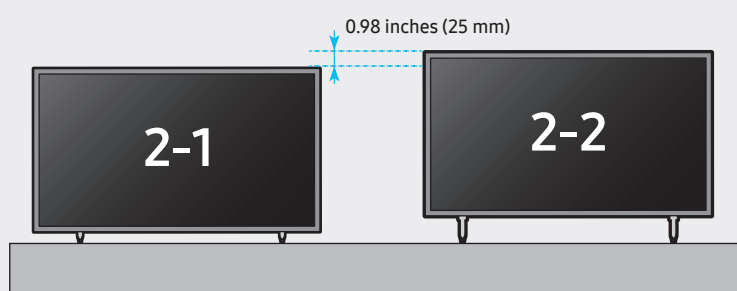
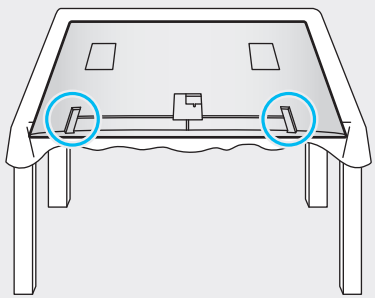

2-1

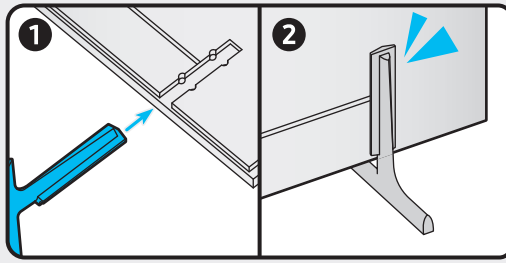
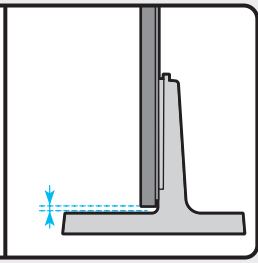
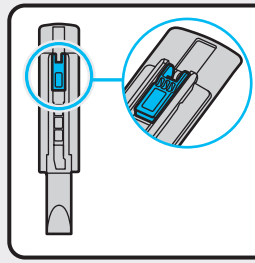
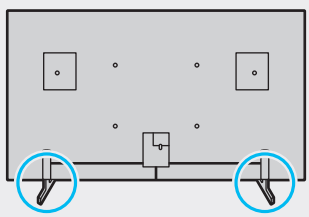

2-2

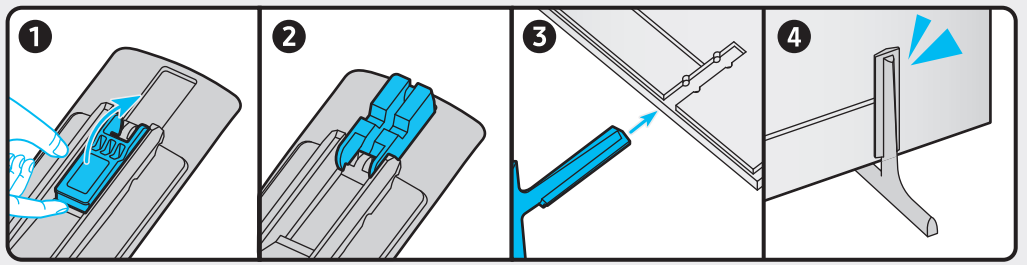
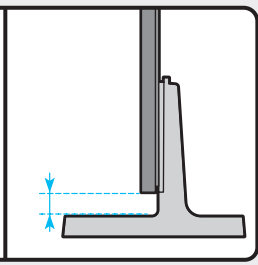
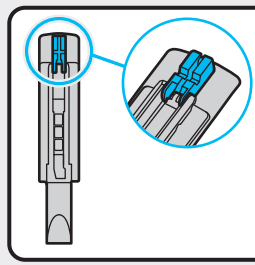
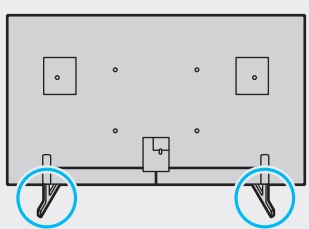

3

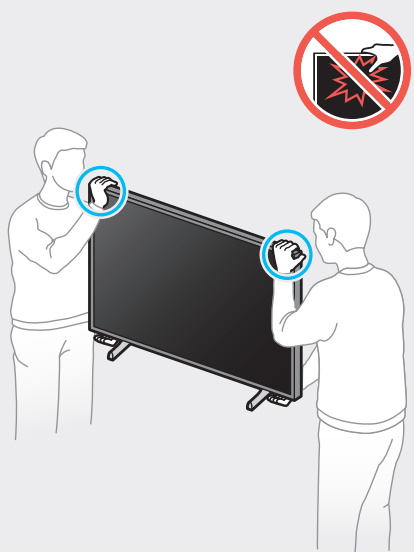

4

