



INSTALLATION AND OPERATION MANUAL

Reverse Osmosis system
ML RO 100-1500 series.



Thank you for choosing Condair

Installation date (MM/DD/YYYY):

Commissioning date (MM/DD/YYYY):

Site:

Model:

Serial number:

Manufacturer

Condair A/S
Parallelvej 2, DK-8680 Ry
phone +45 8788 2100
condair.dk@condair.com, www.condair.dk

Proprietary Notice

This document and the information disclosed herein are proprietary data of Condair A/S. Neither this document, nor the information contained herein shall be reproduced, used, or disclosed to others without the written authorization of Condair A/S, except to the extent required for installation or maintenance of recipient's equipment.

Liability Notice

Condair A/S does not accept any liability due to incorrect installation or operation of the equipment or due to the use of parts/components/equipment that are not authorized by Condair A/S.

Copyright Notice

Copyright 2015, Condair A/S All rights reserved.

Technical modifications reserved

Table of content

1	General information	5
1.1	Foreword	5
1.2	Health and safety	6
1.3	Hygiene	6
1.3.1	Guidelines to ensure your system stays clean and prevent the growth of Legionella	7
1.4	Intended use	8
1.4.1	Ensure safe operation	9
1.5	Warranty	9
1.6	Delivery and storage	9
1.7	Correct method of lifting	9
1.8	Disposal	10
1.8.1	Disinfection	10
2	Product overview	11
2.1	ML RO description	11
2.2	Inlet water quality requirements	12
2.3	MLRO 100 - Piping Diagram	13
2.3.1	MLRO 100 - Part specification	14
2.4	MLRO 300 - Piping Diagram	15
2.4.1	MLRO 300 - Part specification	16
2.5	MLRO 500 - Piping Diagram	17
2.5.1	MLRO 500 - Part specification	18
2.6	MLRO 800 - Piping Diagram	19
2.6.1	MLRO 800 - Part specification	20
2.7	MLRO 1000 - Piping Diagram	21
2.7.1	MLRO 1000 - Part specification	22
2.7.2	MLRO 1500 - Piping Diagram	23
2.7.3	MLRO 1500 - Part specification	24
2.8	Optional equipment for ML RO	25
2.9	Rating and markings	26
2.10	Electrical schematic diagrams	26
3	Installation	27
3.1	Important notes on installation	27
3.1.1	Qualification of personnel	27
3.1.2	Safety	27
3.1.3	Tools needed for installation work	28
3.1.4	Please observe the following on positioning and installation	28
3.2	Positioning the pump station	29
3.2.1	Drain	30
3.2.2	Water connection	30
3.3	Electrical installation	31

Table of content

4	Installation	32
4.1	Tools and materials for commissioning work	32
4.2	Inlet filter	33
4.3	Insert RO membrane	34
4.4	RO tank breathing filter	35
4.5	Basic set-up of the system	35
4.6	Option setup	38
4.7	RO membrane flush and startup	41
4.8	Adjusting the reverse osmosis	42
4.8.1	Water quality	43
4.8.2	Adjustment of outlet amount	44
4.8.3	Adjustment of permeate amount	45
5	Operation	46
5.2	Overview cabinet	46
5.1	Equipment protection	46
5.3	Alarm message	47
5.4	Controller menu	49
5.4.1	Start page - basic settings	49
5.4.2	Operation and menu page	50
5.4.3	Alarm messages	51
5.4.4	Pump setup	51
5.4.5	Pages for the EC monitoring and regulation (option)	52
5.5	Weekly inspection	53
6	Weekly inspection	54
6.1	Important notes on maintenance	54
6.2	Maintenance work	54
6.3	Preventive spare parts chart	56
6.4	Weekly check list	57
6.5	Troubleshooting	58
6.5.1	Qualification of personnel	58
6.5.2	Safety	58
6.5.3	Resetting the error indication	60
6.5.4	Resetting the error indication	61
7	Product data	62
8	Declaration of conformity	64
9	Appendices	65

1 General information

1.1 Foreword

This manual has been written to ensure the safe use, performance and longevity of the equipment, and is intended for use by engineers and properly trained technical personnel. Please read this manual thoroughly before specifying, designing or installing an ML-System from Condair A/S. Keep for future reference.

As our policy is one of continuous research and development, we reserve the right to amend, without notice, the specifications provided in this document. Condair A/S does not guarantee nor accept liability for the accuracy of information in this document.

 **DANGER!**
Danger of electric shock!

Installations and electrical connection must only be done by trained technicians and according to local standards.

High voltages, danger of electric shock! Touching live parts may cause severe injury or death.

 **WARNING!**

Do not retighten/unscrew hoses while the system is pressurised!

The system start-up must be carried out or monitored by persons approved and trained by Condair. Errors in the start-up phase may ultimately result in illness, injury and death of humans.

 **CAUTION!**

Do not use oil, grease, glue, Teflon, silicon, O-ring lubrication, etc. when assembling pipes or hose connections.

All of the above products can act as food for bacteria and are thus pose health risks.

Only approved lubricant: Dish soap.

Wash your hands before or wear clean gloves while assembling parts in direct contact with water. Keep dust covers on pipes and hoses until just before assembly.

Do not fasten the pump station or hoses/pipes to vibrating installations

When fitting water filters, RO membranes, hoses and other components in direct contact with water please, wear sterile gloves or touch only the packing paper to keep the filter bacteria-free.

Remember to wash your hands!

1.2 Health and safety

Installation, maintenance, repair work or decommissioning should only be carried out by appropriately qualified and properly trained technical personnel. The users are responsible for ensuring their suitability. The customer is responsible for ensuring that the installation of the equipment complies with all local regulations.

Any risks or hazards relating to the system, including during installation and maintenance, should be identified by a competent health and safety representative who is responsible for introducing effective control measures.

All ideograms, signs and markings applied to the unit must be observed and kept in a readable state.

1.3 Hygiene

Please observe the local health and safety executive's technical guidance on the control of Legionellosis in water systems.

The user is responsible for ensuring that the water system complies with local regulations, bylaws and guidelines (such as the HSE ACoP L8, VDI 6022, ISO 22000, HACCP or equivalent). If inadequately maintained, the RO-system, can support the growth of microorganisms, including the bacterium that causes Legionnaires' disease.

The ML RO is produced according to the ISO 22000 standards, which means that we have considered all aspects of this equipment to reduce the risk of Legionnaires' disease and other similar conditions. However, the user is responsible for ensuring that the installation, operation and maintenance work on the equipment is performed in a manner ensuring that the system stays clean!

Any risks or hazards relating to the system, including during installation and maintenance, should be identified by a competent health and safety representative who is responsible for introducing effective control measures.



The ML RO must be installed, operated and maintained in accordance with this manual. Failure to do so could result in contamination that might cause Legionnaires' disease, which can be fatal.



To prevent water stagnation and microbial contamination, the ML RO power supply should be left switched on. If the system is switched off for more than 48 hours, the pipework and system must be disinfected as per the instructions, and a full risk assessment must be undertaken to ensure safe operation.

1.3.1 Guidelines to ensure your system stays clean and prevent the growth of Legionella

- Carry out a risk assessment of the water system using a competent person, and implement an appropriate monitoring and control programme.
- Initiate procedures for checking the UV system, cleaning tanks, changing filters, disinfection etc.
- The ML RO must be connected to a clean, potable mains water supply.
- Enter into a service contract that suits your company
- Stop the system if polluted drinking water is found in your area.
- Avoid water temperatures between 25°C and 45°C that favour the growth of Legionella.
- Do not stop the system unless it is faulty or leaking (avoid water stagnation)
- Refrain from closing nozzles or sections, unless there is leakage or a fault (avoid water stagnation)
- Disinfect the high-pressure system at least once a year and after every maintenance or repair.
Always carry out a complete system disinfection if it has been turned off for more than 48 hours
- Have water samples taken and tested for harmful bacteria at least once a year.
- Conduct follow-up measurements until the system is clean if bacteria have been detected in the system.

The Condair service team can help. Condair has expert technicians who can provide:

- Bacteriological troubleshooting on site *
- Cleaning and disinfecting
- Preventive maintenance
- Repair and fault finding
- Training and guidance

*Condair uses a quick method for measuring bacterial activity in the water: the approved and patented BactiQuant. Once the water sample has been taken, we can read the bacteriological quality of the water within 30 minutes, and disinfect the system if necessary.

Condair follows the guidelines in VDI 6022 for CFU counts in humidifiers. The CFU count in the humidification water must not exceed 150 CFU/ml, corresponding to a maximum BQ value of 40. Please contact your local Condair representative for further information about our services.

1.4 Intended use

The ML RO is designed for producing RO water and delivering this from its holding tank at a pressure of 3 bars. Any other, or further, application is not considered use for the intended purpose. Condair A/S cannot be made liable for any damage or injury attributable to inattentive, inappropriate, negligent or incorrect operation of the equipment, whether or not caused deliberately.

Operation of the equipment in the intended manner requires that all the information in this installation and operation manual be observed (in particular the safety instructions).

Potential danger related to the ML RO.



Risk of electric shock! A person may come in contact with live parts when the pump station/control unit is open. Touching live parts may cause severe injury or death.

Prevention: Before carrying out any work on the system, disconnect power and water supply.



Poorly maintained RO systems may be hazardous.

Prevention: read, understand and follow maintenance guidelines to ensure your system stays safe.



Water produced from a RO system is very aggressive and can cause metals to corrode quickly. The RO system should always be connected to piping / equipment suitable for handling RO water.

1.4.1 Ensure safe operation

If it is suspected that safe operation has been compromised, the ML RO should immediately be shut down and secured against accidental power-up.
Shut down the ML RO if:

- ML RO components are damaged, worn or very soiled.
- The ML RO does not work correctly.
- Joints, pipes or hoses are leaking.

No modifications must be made on the ML RO without the manufacturer's consent. All persons working with the ML RO must report any alterations made to the ML RO to the owner immediately.
Use only original accessories and spare parts available from your Condair representative.

1.5 Warranty

ML RO parts are covered by a two-year warranty from the invoice date with the exception of the replacement parts listed in the routine maintenance section. Failure to observe the manufacturer's installation and maintenance recommendations and instructions will invalidate the warranty. Condair A/S cannot be made liable for damage or injury attributable to failure to observe the manufacturer's installation and maintenance recommendations and instructions

1.6 Delivery and storage

To ensure consistent quality, each ML RO is tested and preserved before leaving the factory. If put into storage prior to use, the ML RO must be covered and protected from physical damage, dust, frost and rain. It is recommended that the ML RO be kept in its transit packaging for as long as possible prior to installation.

Inspection

Upon receipt, remove the transit packaging and inspect the unit to ensure that no damage has occurred during transit. Any visible damage must be reported to your Condair distributor immediately. If the unit is put into storage, the packaging should be replaced.

1.7 Correct method of lifting

Lifting or handling must only be carried out by trained and qualified personnel. Ensure that the lifting operation has been properly planned and risk-assessed, and that all equipment has been checked by a skilled and competent health and safety representative.

The customer is responsible for ensuring that operators are trained in handling heavy goods, and to enforce the relevant lifting regulations. Refer to the weights and measures section for system weight.

1.8 Disposal

You must observe local laws and regulations when disposing of your ML RO at the end of its working life. The pumps and piping are constructed from stainless steel which may be fully recycled.

1.8.1 Disinfection

Depending on the system hygiene, it is advised that preventative disinfection fluid is added to the ML RO water tank at an appropriate frequency, but at least once a year.

Condair A/S recommends adding the disinfection fluid SANOSIL S010 AG 5% (our code: 155404000) to the tank, desired concentration 0.1%. SANOSIL is safe, non-toxic and eco-friendly which provides a prophylactic, disinfection dose and is effective against all types of microorganisms, including Legionella and E.coli.

Please read the Maintenance section for more information on disinfection.

If you are in any doubt about the suitability of water quality, please contact your Condair distributor who will be happy to support you.

2 Product overview

2.1 ML RO description

Reverse osmosis system (from now on called RO) with reservoir tank for removal (>95%) of salts and minerals in tap water.

The systems are developed by Condair A/S with focus on reliable and hygienically correct solutions. The system uses a membrane separation process in which water molecules can pass through the membrane, while the majority of salts and minerals are retained and thereafter flushed out the drain.

The system components are fitted on an 'easy-to-place' base frame. The ML RO 100 and 300 has 55/15 liter/gal holding tank for the produced RO water, mounted directly on the pump frame. The holding tanks of ML RO 500, 800, 1000 and 1500 are placed on separate frames (200/53, 500/132, 1000/264 liter/gal).

There are two or three pumps on the pump frame: The RO pump(s) which pumps the raw water through the RO membrane at a pressure of 8-12 bar and into the RO water tank. RO water transfer pump, which delivers pressurized RO water to the consumer at 3,5 bar.

All components exposed to water are made of corrosion-resistant material. All hoses are steel-reinforced and drinking water-approved.

Both the transfer and RO pump are directly mounted on their electric motors. Power is supplied to the 3-phase asynchronous motors via a magnet-operated protective motor switch.

The transfer pump is protected against dry running by the level sensor in the RO tank that stops the system if the tank is empty.

A pressure switch just after the inlet filter protects the RO pump from dry running.

The control unit consists of a touch display and a PLC mounted in the IP 65-rated electrical cabinet.

From the touch screen, the operator can change settings, adjust alarm limits and view hour counters, logged alarms, etc.

The ML RO's are delivered assembled, tested, and ready to use.

2.2 Inlet water quality requirements

The quality of the water being used in the ML RO system should be checked prior to system commissioning. Condair A/S recommends that the ML RO system is connected to a clean, potable (drinking water quality) mains water supply. If the inlet water does not meet the quality specified in the preconditions table, it may be necessary to install additional water treatment.

Preconditions:	
ML RO 100 consumption and inlet pressure	200 L/h @ 2.5-7 bar (dynamic)
ML RO 300 consumption and inlet pressure	600 L/h @ 2.5-7 bar (dynamic)
ML RO 500 consumption and inlet pressure	700 L/h @ 2.5-7 bar (dynamic)
ML RO 800 consumption and inlet pressure	1100 L/h @ 2.5-7 bar (dynamic)
ML RO 1000 consumption and inlet pressure	1400 L/h @ 2.5-7 bar (dynamic)
ML RO 1500 consumption and inlet pressure	2100 L/h @ 2.5-7 bar (dynamic)
Connection inlet:	G 3/4"
Connection outlet:	G 3/4"
Water supply:	Potable water quality
Hardness: ML RO 100, 300:	max 20 °dH
Hardness: ML RO 500, 800, 1000, 1500:	max 1 °dH
Conductivity:	120-1000 µS/cm
Free chlorine:	0,1 mg/L
TDS:	max 625 mg/L
Silt index:	max 3.0
KMnO4:	max 10 mg/L
Fe:	max 0.2 mg/L
Mn:	max 0.05 mg/L
NTU:	max 1.0
Temperature of inlet water:	max 40°C <i>Recommended max 15°C (hygienic precaution)</i>

2.3 MLRO 100 - Piping Diagram

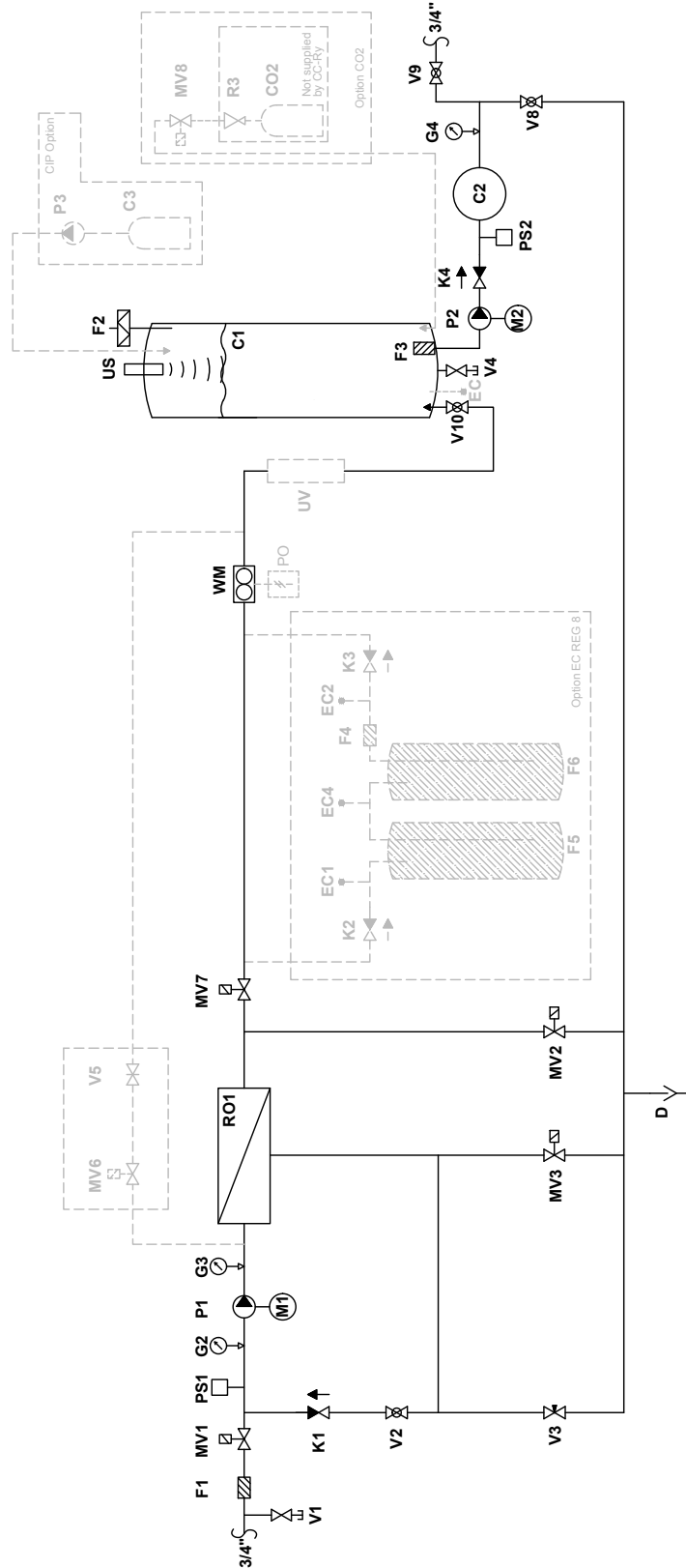

2.3.1 MLRO 100 - Part specification

C1	Permeate tank, 55 L
C2	Hydrophore, 8 L
D	Drain pipe, 3/4" RG
F1	Filter 20", 5 µm
F2	Sterile breathing filter 0,2 µm
F3	Suction filter
G2	Pressure gauge, inlet pressure RO pump 0-10 bars
G3	Pressure gauge, RO pump pressure 0-10 bars
G4	Pressure gauge, 0-10 bars
K1	Check valve 16 bar, back pressure max 0,1 bar
K4	Check valve
M1/P1	RO pump
M2/P2	Feed pump
MV1	ON/OFF valve, 0-10 bars
MV2	Valve for flushing at start-up
MV3	Valve for membrane flushing
MV7	ON/OFF valve
PS1	Pressure switch, pre-adjusted to 0.5 bar
PS2	Pressure switch, type CS
RO1	RO membrane in stainless steel housing
US	Ultra sound level sensor
V1	Test water tap 1/8"
V2	Ball valve for pressure adjustment
V3	Needle valve for concentrate outlet adjustment
V4	Test water tap 1/8"
V8	Ball valve
V9	Ball valve
V10	Ball valve
WM	Water meter for permeate
Misc. options	
MV6 (Option)	Valve for raw water mix, 0-10 bars
UV (Option)	UV system
V5 (Option)	Needle valve
CO ₂ option	
CO2 (Option)	CO ₂ container
MV8 (Option)	Valve for CO ₂
R3 (Option)	CO ₂ pressure regulator
CIP option	
C3 (Option)	CIP container, 1 L plastic bottle
P3 (Option)	CIP pump
EC REG 8 option	
EC1 (Option)	Conductivity sensor
EC2 (Option)	Conductivity sensor
EC4 (Option)	Conductivity sensor
F4 (Option)	Filter, 5" 5 µ
F5 (Option)	Mixedbed, ion exchange bottle (Acquired locally)
F6 (Option)	Mixedbed, ion exchange bottle (Acquired locally)
K2 (Option)	Check valve
K3 (Option)	Check valve
EC option	
EC (Option)	Conductivity sensor
PO option	
PO (Option)	Pulse output for water meter

2.4 MLRO 300 - Piping Diagram

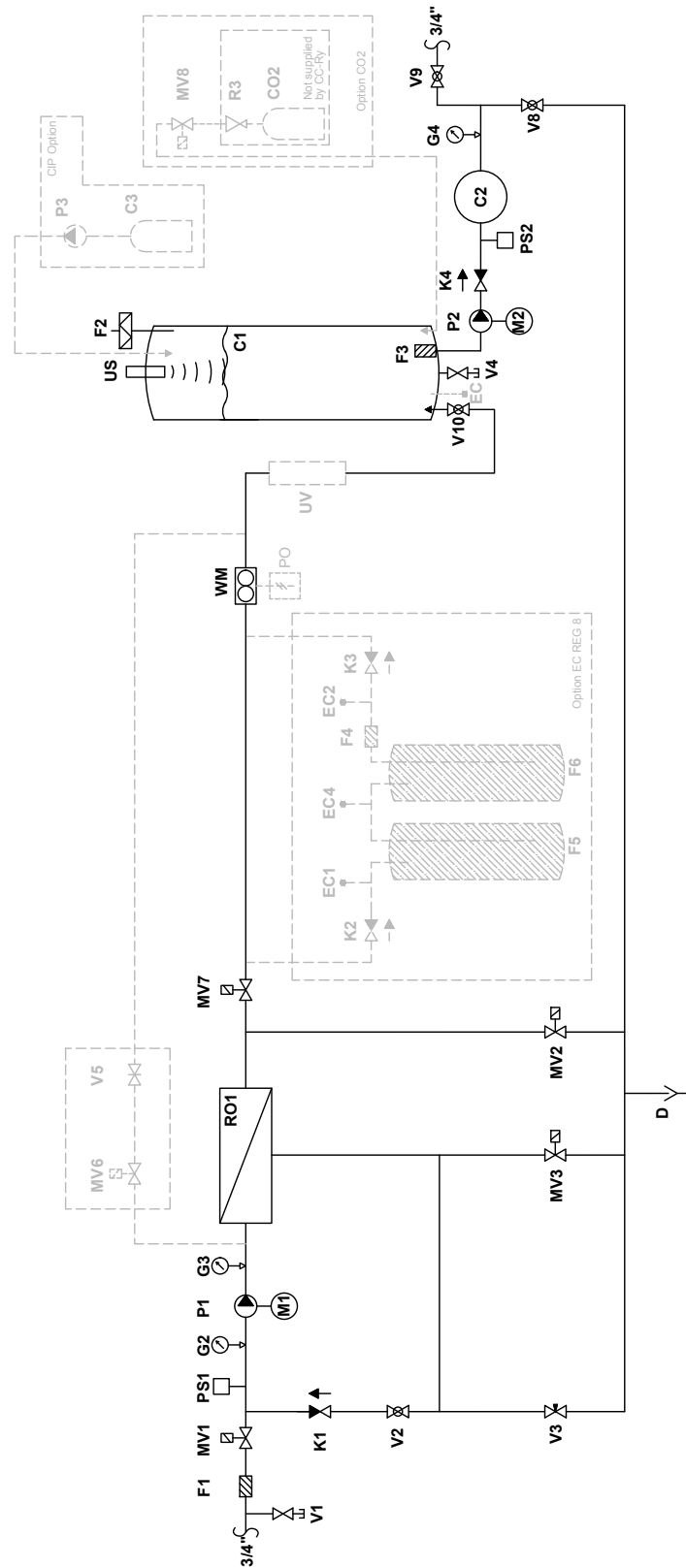

2.4.1 MLRO 300 - Part specification

C1	Permeate tank, 55 L
C2	Hydrophore, 8 L
D	Drain pipe, 3/4" RG
F1	Filter 20", 5 µm
F2	Sterile breathing filter 0,2 µm
F3	Suction filter
G2	Pressure gauge, inlet pressure RO pump 0-10 bars
G3	Pressure gauge, RO pump pressure 0-10 bars
G4	Pressure gauge, 0-10 bars
K1	Check valve 16 bar, back pressure max 0,1 bar
K4	Check valve
M1/P1	RO pump
M2/P2	Feed pump
MV1	ON/OFF valve, 0-10 bars
MV2	Valve for flushing at start-up
MV3	Valve for membrane flushing
MV7	ON/OFF valve
PS1	Pressure switch, pre-adjusted to 0.5 bar
PS2	Pressure switch, type CS
RO1	RO membrane in stainless steel housing
US	Ultra sound level sensor
V1	Test water tap 1/8"
V2	Ball valve for pressure adjustment
V3	Needle valve for concentrate outlet adjustment
V4	Test water tap 1/8"
V8	Ball valve
V9	Ball valve
V10	Ball valve
WM	Water meter for permeate
Misc. options	
MV6 (Option)	Valve for raw water mix, 0-10 bars
UV (Option)	UV system
V5 (Option)	Needle valve
CO ₂ option	
CO2 (Option)	CO ₂ container
MV8 (Option)	Valve for CO ₂
R3 (Option)	CO ₂ pressure regulator
CIP option	
C3 (Option)	CIP container, 1 L plastic bottle
P3 (Option)	CIP pump
EC REG 8 option	
EC1 (Option)	Conductivity sensor
EC2 (Option)	Conductivity sensor
EC4 (Option)	Conductivity sensor
F4 (Option)	Filter, 5" 5 µ
F5 (Option)	Mixedbed, ion exchange bottle (Acquired locally)
F6 (Option)	Mixedbed, ion exchange bottle (Acquired locally)
K2 (Option)	Check valve
K3 (Option)	Check valve
EC option	
EC (Option)	Conductivity sensor
PO option	
PO (Option)	Pulse output for water meter

2.5 MLRO 500 - Piping Diagram

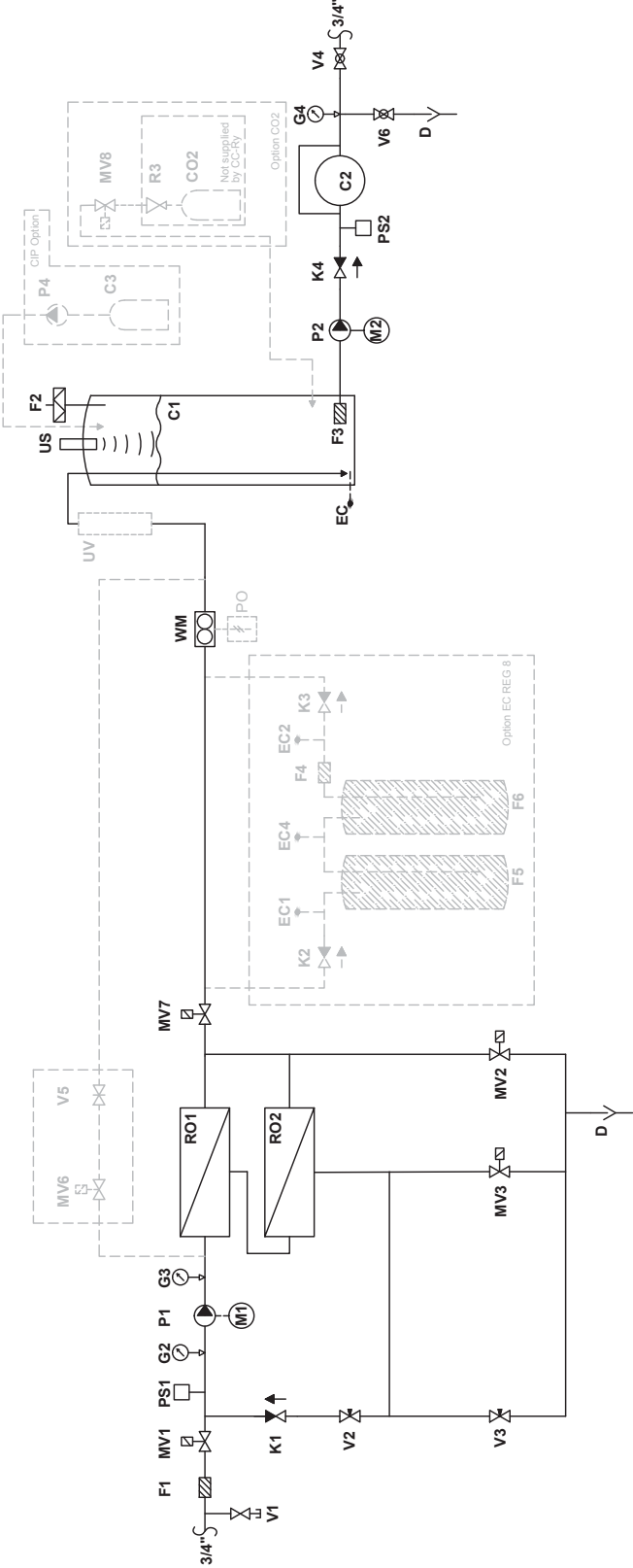

2.5.1 MLRO 500 - Part specification

C	Permeate tank, 200 L, external on stand
C2	Hydrophore, flowthrough, 8 L
D	Drain pipe, 3/4" RG
F1	Filter 20", 5 µm
F2	Sterile breathing filter 0,2 µm
F3	Suction filter
G2	Pressure gauge, inlet pressure RO pump 0-10 bars
G3	Pressure gauge, RO pump pressure 0-10 bars
G4	Pressure gauge
K1	Check valve
K4	Check valve
M1/P1	RO pump
M2/P2	Feed pump
MV1	ON/OFF valve, 0-10 bars, 3/4"
MV2	Valve for flushing at start-up
MV3	Valve for membrane flushing
MV7	ON/OFF valve
P2	PAHT high pressure pump 70 bars
PS1+2	Pressure switch, pre-adjusted to 0.5 bar
RO1-2	RO membrane in stainless steel housing
US	Ultra sound level sensor
V1	Test water tap 1/8"
V2	Valve for pressure adjustment
V3	Needle valve for concentrate outlet adjustment
V4	Ball valve
V6	Drain valve
WM	Water meter for permeate
Misc. options	
MV6 (Option)	Valve for raw water mix, 0-10 bars
UV (Option)	UV system
V5 (Option)	Needle valve
CO ₂ option	
CO2 (Option)	CO ₂ container
MV8 (Option)	Valve for CO ₂
R3 (Option)	CO ₂ pressure regulator
CIP option	
C3 (Option)	CIP container, 1 L plastic bottle
P3 (Option)	CIP pump
EC REG 8 option	
EC1 (Option)	Conductivity sensor
EC2 (Option)	Conductivity sensor
EC4 (Option)	Conductivity sensor
F4 (Option)	Filter, 5" 5 µ
F5 (Option)	Mixedbed, ion exchange bottle (Acquired locally)
F6 (Option)	Mixedbed, ion exchange bottle (Acquired locally)
K2 (Option)	Check valve
K3 (Option)	Check valve
EC option	
EC (Option)	Conductivity sensor
PO option	
PO (Option)	Pulse output for water meter

2.6 MLRO 800 - Piping Diagram

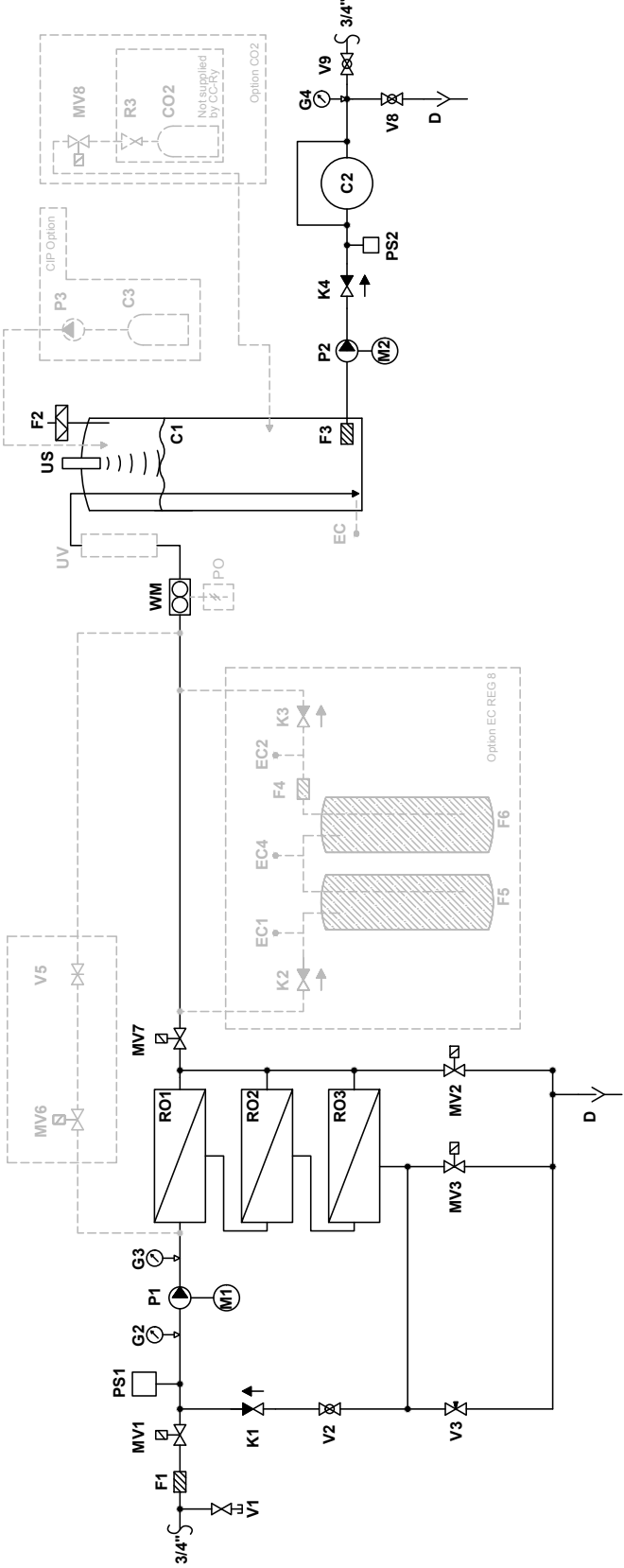

2.6.1 MLRO 800 - Part specification

C1	Permeate tank, 500 L external on stand, black plastic
C2	Hydrophore, flowthrough, 8 L
D	Drain pipe, 3/4" RG
F1	Filter 20", 5 µm
F2	Sterile breathing filter 0,2 µm
F3	Suction filter
G2	Pressure gauge, inlet pressure RO pump 0-10 bars
G3	Pressure gauge, RO pump pressure 0-10 bars
G4	Pressure gauge, 0-10 bars
K1	Check valve 16 bar, back pressure max 0,1 bar
K4	Check valve
M1/P1	RO pump
M2/P2	Feed pump
MV1	ON/OFF valve, 0-10 bars
MV2	Valve for flushing at start-up
MV3	Valve for membrane flushing
MV7	ON/OFF valve
PS1	Pressure switch, pre-adjusted to 0.5 bar
PS2	Pressure switch, type CS
RO1-3	RO membrane in stainless steel housing
US	Ultra sound level sensor
V1	Test water tap 1/8"
V2	Ball valve for pressure adjustment
V3	Needle valve for concentrate outlet adjustment
V8	Ball valve
V9	Ball valve
WM	Water meter for permeate
Misc. options	
MV6 (Option)	Valve for raw water mix, 0-10 bars
UV (Option)	UV system
V5 (Option)	Needle valve
CO ₂ option	
CO2 (Option)	CO ₂ container
MV8 (Option)	Valve for CO ₂
R3 (Option)	CO ₂ pressure regulator
CIP option	
C3 (Option)	CIP container, 1 L plastic bottle
P3 (Option)	CIP pump
EC REG 8 option	
EC1 (Option)	Conductivity sensor
EC2 (Option)	Conductivity sensor
EC4 (Option)	Conductivity sensor
F4 (Option)	Filter, 5" 5 µ
F5 (Option)	Mixedbed, ion exchange bottle (Acquired locally)
F6 (Option)	Mixedbed, ion exchange bottle (Acquired locally)
K2 (Option)	Check valve
K3 (Option)	Check valve
EC option	
EC (Option)	Conductivity sensor
PO option	
PO (Option)	Pulse output for water meter

2.7 MLRO 1000 - Piping Diagram

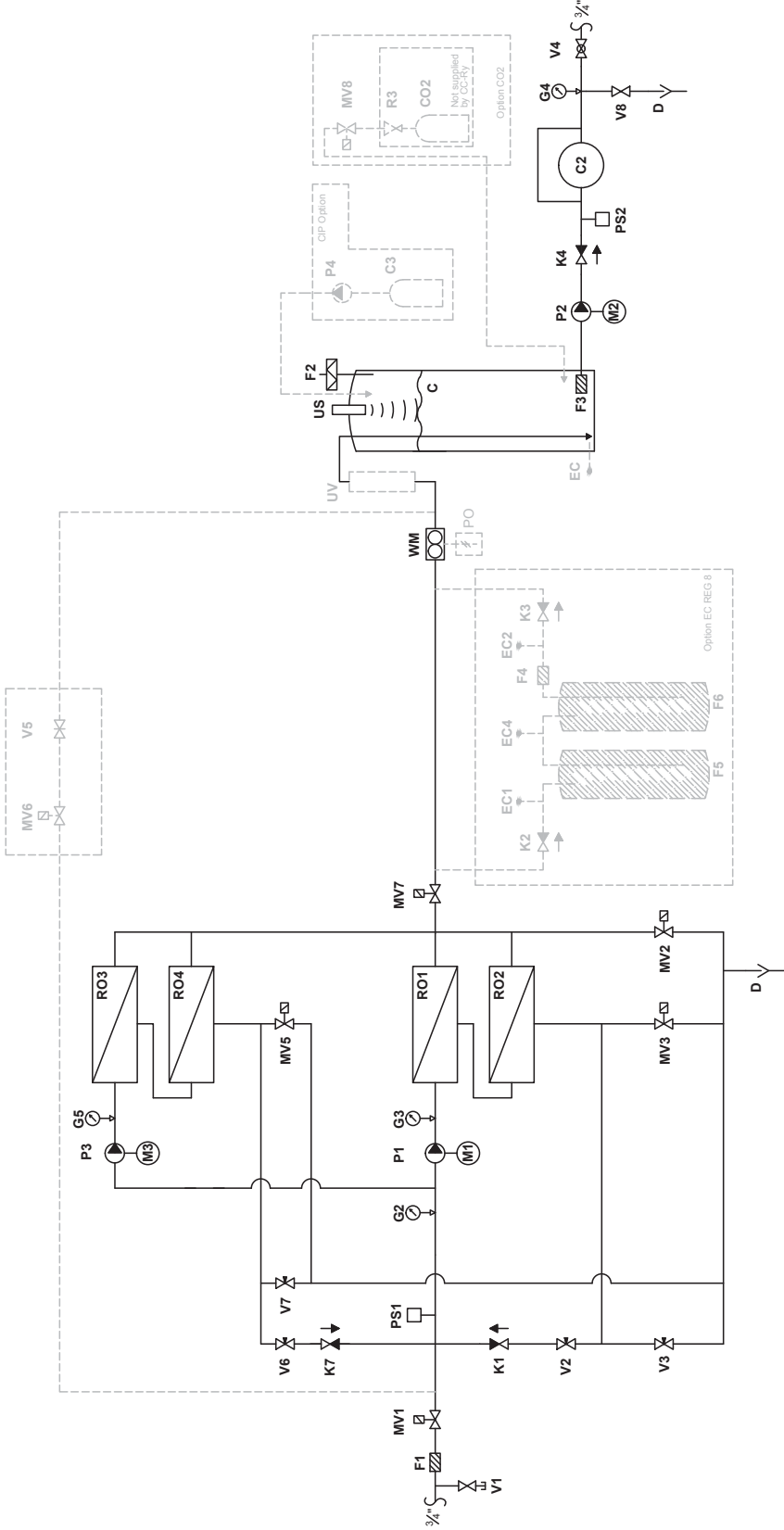

2.7.1 MLRO 1000 - Part specification

C	Permeate tank, 500 L external on stand, black plastic
C2	Hydrophor, flowthrough, 8 L
D	Drain pipe, 3/4" RG
F1	Filter 20", 5 µm
F2	Sterile breathing filter 0,2 µm
F3	Suction filter
G2	Pressure gauge, inlet pressure RO pump 0-10 bars
G3+G5	Pressure gauge, RO pump pressure 0-10 bars
G4	Pressure gauge
K1	Check valve 16 bar, back pressure max 0,1 bar
K4	Check valve
M1/P1	RO pump
M2/P2	Feed pump
M3/P3	RO pump
MV1	ON/OFF valve, 0-10 bars
MV2	Valve for flushing at start-up
MV3+MV5	Valve for membrane flushing
MV7	ON/OFF valve
PS1	Pressure switch, pre-adjusted to 0.5 bar
PS2	Pressure switch, type CS
RO1-4	RO membrane in stainless steel housing
US	Ultra sound level sensor
V1	Test water tap 1/8"
V2+V6	Valve for pressure adjustment
V3+V7	Needle valve for concentrate outlet adjustment
V4	Ball valve
V8	Drain valve
WM	Water meter for permeate
Misc. options	
MV6 (Option)	Valve for raw water mix, 0-10 bars
UV (Option)	UV system
V5 (Option)	Needle valve
CO ₂ option	
CO2 (Option)	CO ₂ container
MV8 (Option)	Valve for CO ₂
R3 (Option)	CO ₂ pressure regulator
CIP option	
C3 (Option)	CIP container, 1 L plastic bottle
P4 (Option)	CIP pump
EC REG 8 option	
EC1 (Option)	Conductivity sensor
EC2 (Option)	Conductivity sensor
EC4 (Option)	Conductivity sensor
F4 (Option)	Filter, 5" 5 µ
F5 (Option)	Mixedbed, ion exchange bottle (Acquired locally)
F6 (Option)	Mixedbed, ion exchange bottle (Acquired locally)
K2 (Option)	Check valve
K3 (Option)	Check valve
EC option	
EC (Option)	Conductivity sensor
PO option	
PO (Option)	Pulse output for water meter

2.7.2 MLRO 1500 - Piping Diagram

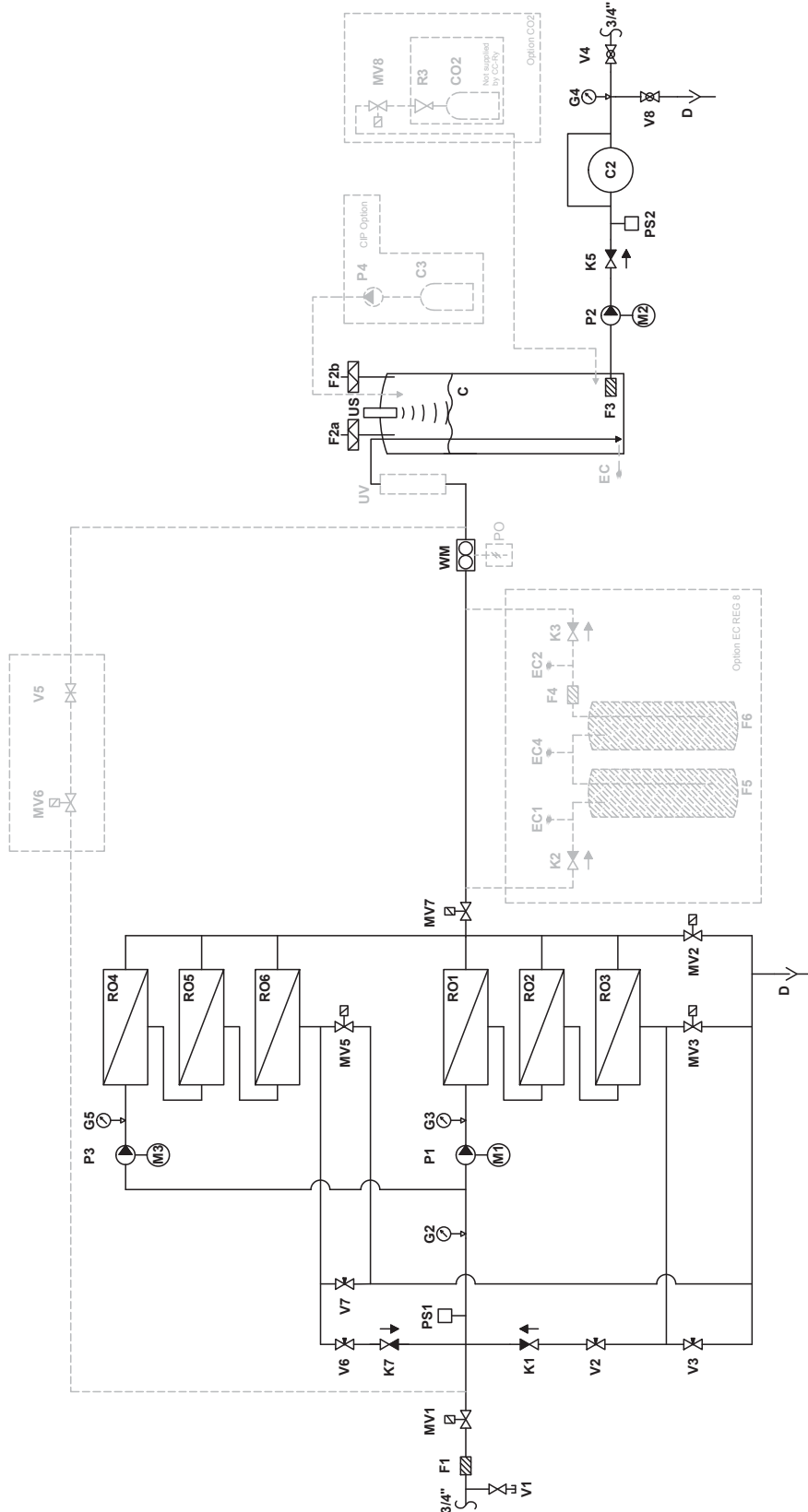

2.7.3 MLRO 1500 - Part specification

C	Permeate tank, 500 L external on stand, black plastic
C2	Hydrophor, flowthrough, 18 L
D	Drain pipe, 3/4" RG
F1	Filter 20", 5 µm
F2a+b	Sterile breathing filter 0,2 µm
F3	Suction filter
G2	Pressure gauge, inlet pressure RO pump 0-10 bars
G3+G5	Pressure gauge, RO pump pressure 0-10 bars
G4	Pressure gauge
K1	Check valve
K5	Check valve
M1/P1	RO pump
M2/P2	Feed pump
M3/P3	RO pump
MV1	ON/OFF valve, 0-10 bars
MV2	Valve for flushing at start-up
MV3+MV5	Valve for membrane flushing
MV7	ON/OFF valve, 0-10 bars
PS1	Pressure switch, pre-adjusted to 0.5 bar
PS2	Pressure switch, type CS
RO1-6	RO membrane in stainless steel housing
US	Ultra sound level sensor
V1	Test water tap 1/8"
V2+V6	Valve for pressure adjustment
V3+V7	Needle valve for concentrate outlet adjustment
V4	Ball valve
V8	Drain valve
WM	Water meter for permeate
Misc. options	
MV6 (Option)	Valve for raw water mix, 0-10 bars
UV (Option)	UV system
V5 (Option)	Needle valve
CO ₂ option	
CO2 (Option)	CO ₂ container
MV8 (Option)	Valve for CO ₂
R3 (Option)	CO ₂ pressure regulator
CIP option	
C3 (Option)	CIP container, 1 L plastic bottle
P4 (Option)	CIP pump
EC REG 8 option	
EC1 (Option)	Conductivity sensor
EC2 (Option)	Conductivity sensor
EC4 (Option)	Conductivity sensor
F4 (Option)	Filter, 5" 5 µ
F5 (Option)	Mixedbed, ion exchange bottle (Acquired locally)
F6 (Option)	Mixedbed, ion exchange bottle (Acquired locally)
K2 (Option)	Check valve
K3 (Option)	Check valve
EC option	
EC (Option)	Conductivity sensor
PO option	
PO (Option)	Pulse output for water meter

2.8 Optional equipment for ML RO

Optional and ancillary equipment can be divided into the two groups:

ML RO options: Added features which are integrated into the controller of the ML RO or placed on its frame, e.g UV filter, conductivity measurement, ultra-pure water (mixed bed), CIP system, CO₂ adding.

Pre-treatment: Stand-alone systems for improving the water quality in order to meet the inlet water quality requirements for the ML RO, e.g. booster pump, non-return valve, silt/pre-filter, carbon filter and softener. Ask your local Condair dealer for additional information on pre-treatment equipment

Preconditions:	
UV - Lamp	Adding a UV lamp ensures a high level of hygiene in the produced RO water. Condair a/s strongly recommends having a UV lamp when the RO Water is to be used in a adiabatic humidifier
ML EC REG 1 Conductivity sensor (in RO tank)	Measuring the conductivity (μS) of the RO water in the RO tank, incl. Hi/Low alarms.
ML EC-REG 2 (inlet water mixer)	Mixes inlet water in the produced water from the RO membrane in order to raise the conductivity of the ROwater
ML EC-REG 6 (CO ₂ mixer)	Mixes CO ₂ in the produced water from the RO membrane in order to increase RO water conductivity. (CO ₂ tanks and regulator are not included)
ML EC-REG 7 Mixed bed, preparation for 1 mixed bed filter	1 mixed-bed bottle connection with sensors, alarms and CO ₂ Adding to the tank (CO ₂ tanks and regulator are not included)
ML EC-REG 8 Mixed bed, preparation for double mixed bed filter	2 mixed-bed bottle connection with sensors, alarms and CO ₂ Adding to the tank (CO ₂ tanks and regulator are not included) (Having 2 mixed-bed bottles gives you an early warning when to change the bottle and minimizes the risk of salt breakthroughs)
Log option	Creates a logfile from the EC measurements (NB! Needs one EC-reg option)
BAS/BMS integration Modbus TCP/IP	Displays the operating humidity and alarm status of the system via a TPC/IP protocol.
CIP (clean-in-place)	Function that adds a small amount of disinfection into the water circuit, to prevent bacterial growth.
PLC webserver access	Access to the PLC's homepage from a standard browser. Displays the operating status and humidity for each zone.
Pulse generator for water meter	The water meter is equipped with a pulse emitter which can be linked to tele-reading systems, the PLC and to M-Bus networks.

2.9 Rating and markings

The rating plate is placed in the upper left corner on the side of the control cabinet (when facing the front)



A label with the internal order number and electrical schematic diagram number is placed on the inside of the left-hand cabinet hatch (when facing the front) on the control cabinet).

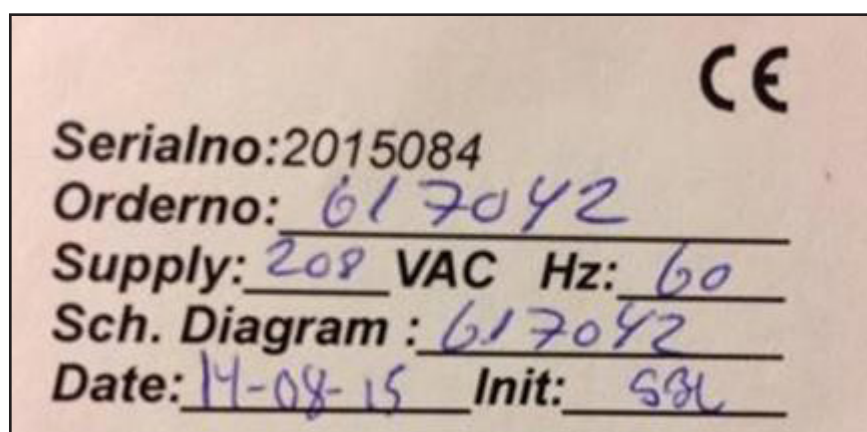

2.10 Electrical schematic diagrams

A copy of the electrical schematic diagrams is placed on the backside of the hatch inside the control panel.

3 Installation

3.1 Important notes on installation



Do not retighten/unscrew hoses while the system is pressurised!



Do not use oil, grease, glue, Teflon, silicon, O-ring lubrication, etc. when assembling pipes or hose connections.

All of the above products can act as food for bacteria and are thus pose health risks. Only approved lubricant: Dish soap.

Wash your hands before or wear clean gloves while assembling parts in direct contact with water. Keep dust covers on pipes and hoses until just before assembly.



Do not fasten the pump station or hoses/pipes to vibrating installations.

3.1.1 Qualification of personnel

All installation work must be performed only by persons familiar with the ML RO system and sufficiently qualified for such work. All work on electric installations must only be performed by adequately qualified electricians.

3.1.2 Safety

The pump station and any control units may only be connected to the mains after all installation work has been completed. All statements relating to correct positioning and installation must be followed and complied with. When installing components of the ML RO, use the materials and hoses supplied with the unit. In case of doubt, please contact your Condair supplier.

3.1.3 Tools needed for installation work

- Screwdriver set
- Bubble level
- Polygrip pliers
- Wire cutters
- Spanner set
- Tape measure
- Marker
- Box cutter

3.1.4 Please observe the following on positioning and installation

- The pump station must be installed only in a location with a drain in the floor
- The site must be freely accessible with sufficient space for convenient operation and maintenance (min. free space around MLRO: laterally 0.5 m, 0.8 m front / back)
- The pump station is designed for operation in a frost-free and dry environment, never outdoors
- Do not install the pump station in exposed locations or locations with heavy dust loads
- The pump station is designed for installation on a load-bearing floor

3.2 Positioning the pump station

Before positioning the ML RO pump and tank, it is important to consider the position of water treatment equipment in the room prior to installing the ML RO unit.

Water treatment installation parts should be installed in the order shown in the figure below. Please note that the combination of water treatment systems will vary from one installation to the next due as a result of water quality and regulatory requirements in the given location. If the Free chlorine level in the water is below the softner's max allowed limit the carbon filter can be installed after the softner to prolong the carbon filters life.

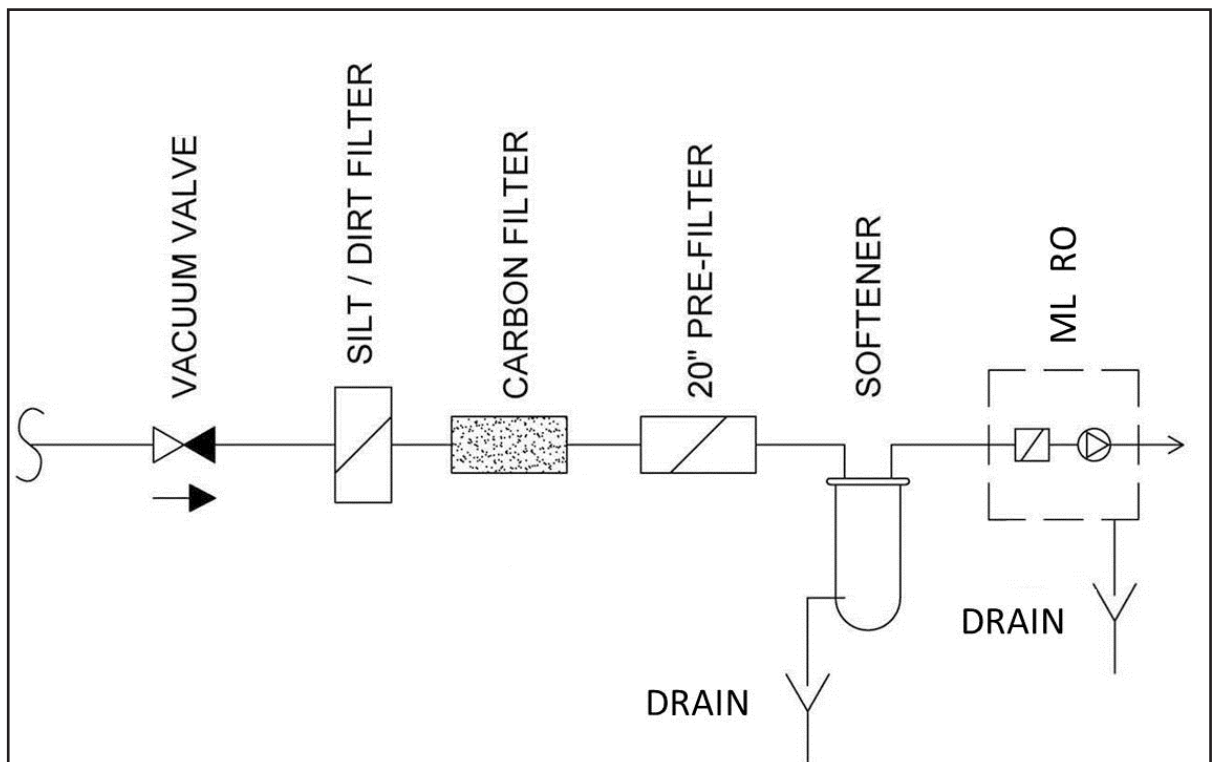

Start by examining the types of water treatment systems to be installed and read their installation requirements for supply and drainage.

Mark the location of the different systems in the room and note any missing supply or drains for the systems. Make sure you have the necessary fixing equipment available: cable ties, cable trays, screws and wall anchors.

Place the ML RO on a hard floor with a drain.

Adjust the screws under each leg on the frame so that the pump station and the RO tank (if relevant) can be levelled. Use a bubble level to ensure that the pump station is perfectly level

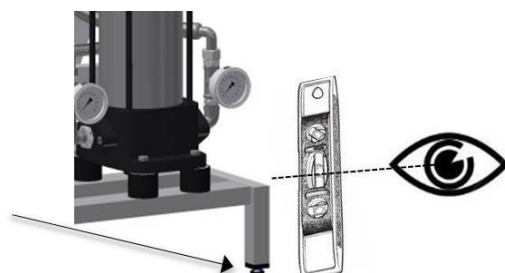

3.2.1 Drain

Connect the ML RO to the floor drain with a tube or hose of a ¾" RG female in the drain connector. On ML RO 500, 800, 1000, 1500 the drain from MV4 on the RO tank must also be led to a drain – either directly or be connected to the drain connector D.

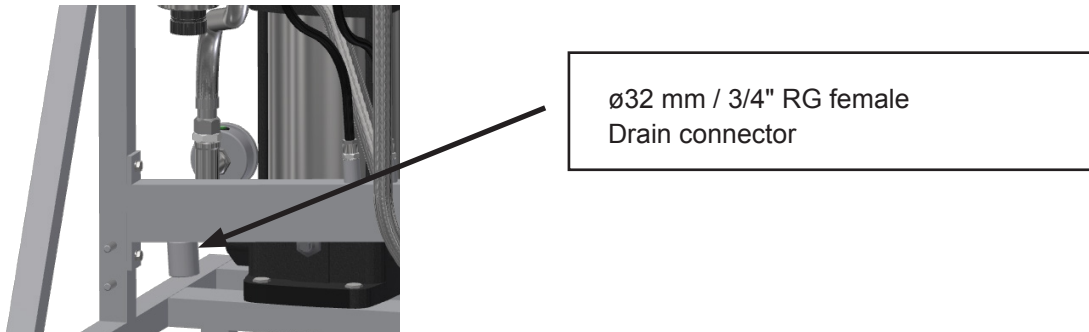

- Remove protecting plug (yellow) from drain connector.
- Connect drain hose to water outlet connector (ø32 mm) and lead the drain hose down to an open funnel with a constant down-slope.
- Fix drain hose in its position, so it cannot move during operation.

The drain must have an appropriate down-slope to allow the water to flow freely and without pressure from the drain connector.

3.2.2 Water connection



Do not open and fill hoses, pumps, filters or tanks with water if the system is not to be started immediately after installation (48 hours). Stagnant water acts as a breeding ground for potentially dangerous micro-organisms.

Before connecting the ML RO to water supply of the building or water treatment system, it must be ensured that the incoming water is as clean as possible. This is done by running a hose from the supply to the drain and open the shut-off valve completely. Let the water run for at least ten minutes. Shut off the water again and connect the ML RO to the water supply with the supplied hose (¾", 1.5m).

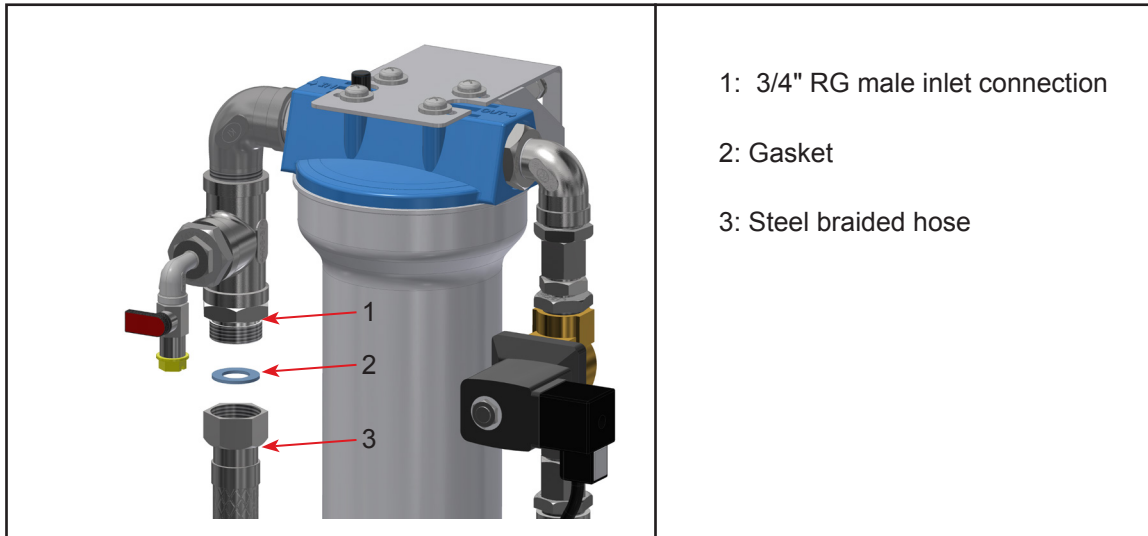

Connect the RO tank (only ML RO 500, 800, 1000, 1500)

All hoses to the internal connections are supplied with ML RO and requires that the RO tank is placed right next to the pumpstation.

3.3 Electrical installation

 **DANGER!**
Danger of electrical shock!

Installations and electrical connection must only be done by trained technicians and according to local standards.

High voltages, danger of electric shock! of electric shock! Touching live parts may cause severe injury or death.

All Connections must be made according to the electrical documentation which is found inside the control unit of the electrical cabinet / main box.

4 Installation



The system start-up must be carried out or monitored by persons approved and trained by Condair. Errors in the start-up phase may ultimately result in illness, injury and death of humans.



When fitting water filters, RO membranes, hoses and other components in direct contact with water please, wear sterile gloves or touch only the packing paper to keep the filter bacteria-free.

Remember to wash your hands!



Commissioning of the pump should be the last thing performed at an installation site. When the pump has run with water and the preservation fluid (windscreen wash) has been flushed out, it should always be kept on (summer and winter) in order to keep the system hygienically clean by allowing it to run its automatic flushing and UV routine.

4.1 Tools and materials for commissioning work

- Screwdriver set (remember small screwdriver for terminals)
- Polygrip pliers
- Spanner set
- Bucket with litre measure
- Residual hardness test kit, quick method onsite test ML-part: 150400000
- Total hardness test kit, quick method onsite test ML-part: 150401000
- Chlorine-sensitive test strips, quick method onsite test ML-part: 155407200
- Conductivity meter
- BQ water analyses set ML part: 155600010
- Multi-meter (Volt, Amp)

Disconnect the power before starting any commissioning work. Turn the main power switch and the start button to the off position.

4.2 Inlet filter

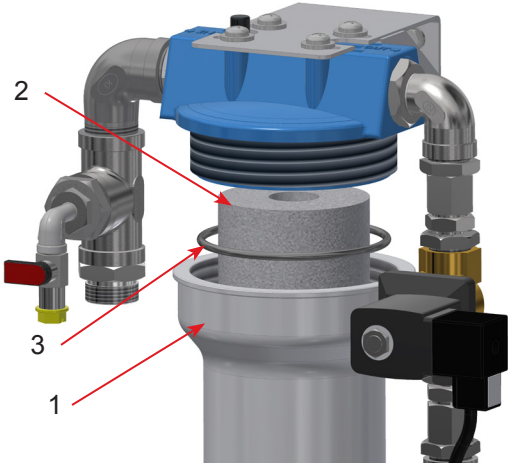
	<p>Inlet filter house and filter</p> <p>Insert filter</p> <ul style="list-style-type: none"> • Unscrew the filter housing [1] using a filter wrench. • Insert the filter [2], and make sure that it is centered on the guide knob at the bottom of the filter housing. • Tighten the filter as much as possible by hand and then use the filter wrench to tighten approx. • 1/4 turn. • Slowly open the water supply • If the filter housing is hard to tighten or leaks, unscrew it and check that the filter is centered, the O-ring (3) is undamaged and the sealing surface is smooth and free of dirt. <p>NB! Do not touch the filter with your bare hands (slide it out of the packing directly into the filter housing).</p>
---	--

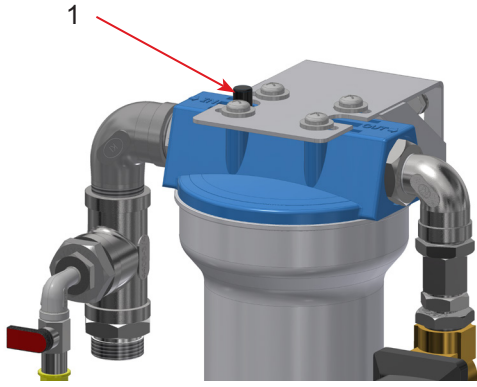
	<p>Air button, inlet filter</p> <p>Airing filter</p> <ul style="list-style-type: none"> • Slowly open the water supply (tap) to the ML RO • Bleed the filter by pushing the air button [1] on the filter top until water leaks continuously. • Release the air button.
---	--

4.3 Insert RO membrane

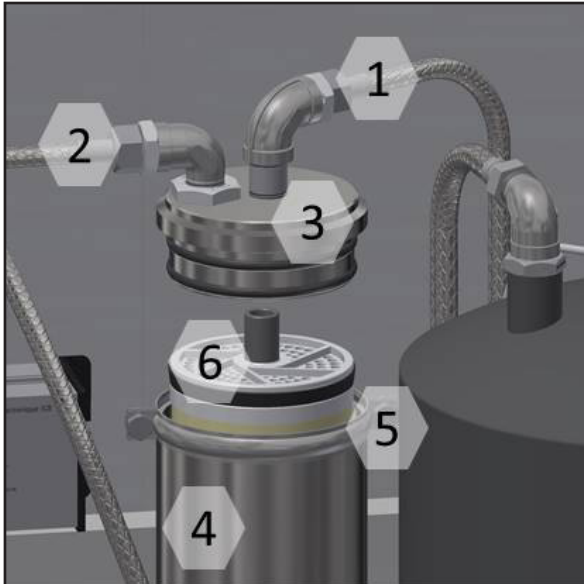

Membrane detail

- 1: Outlet tube
- 2: Inlet tube
- 3: Membrane tube, end cap
- 4: Membrane tube
- 5: hose clamps
- 6: membrane

Start by loosening the hose clamp [5] and then remove the end cap [3] of the membrane tube. Let the membrane [6] slide into the membrane tube [4]. Make sure that the O-ring on the membrane is facing up (protect the membrane against bacteria, hold on the membrane packaging bag).

Press the membrane all the way to the bottom. If there is no resistance at the end, or if the membrane is very difficult to press down, the reason may be that the inner O-rings in the membrane tube end caps are out of place or have fallen out.

Check that both the outer and inner O-rings at the end cap (top and bottom) are in place and undamaged. Now press the end cap in place and reinstall the hose clamp.

NB! Do not use grease or the like to lubricate the O-rings. Moisture with water instead.

4.4 RO tank breathing filter

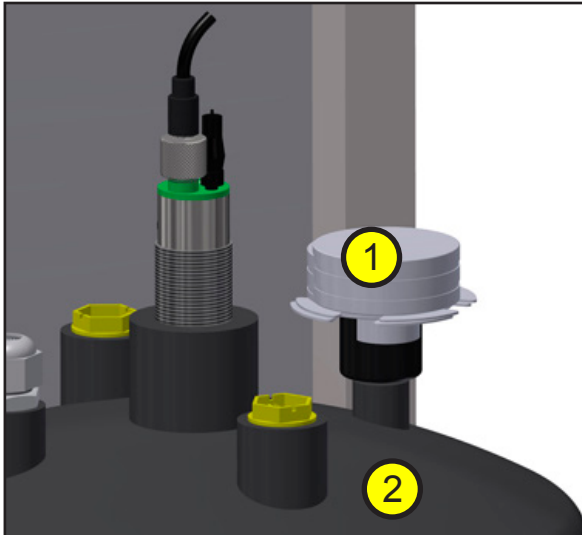

Sterile breathing filter [1] RO tank [2]

Remove the yellow protective cap from the RO tank filter adapter (shaped like a small cup).

Unpack the filter [1] and moisten the O-ring with running water.

Avoid touching the nipple and the O-ring with your bare hands.

Press the sterile breathing filter into the filter adapter.

Before the pump is started for the first time, the controller must be set up and a membrane cleaning performed, follow the steps in the chapter 4.5 Basic set-up of the controller,

4.5 Basic set-up of the system



- Put S1 in OFF position
- Start the controller by turning the power switch S3 in ON position
- The display lights up the start center → ►START

- 1: Display (D2)
- 2: ON/OFF (S1)
- 3: Reset/start (S2/P1)
- 4: Keyhole
- 5: Power switch (S3)



2.0

When power is switched on the start / home screen appears.

* Press F1 to go to the menu.

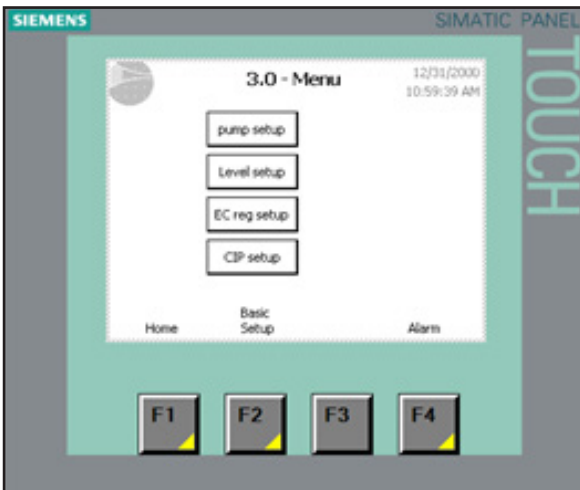

3.0

* Press F2 to go to Basic setup

Use master password: 8599

When a password is required in order to change parameters, a screen will appear where the password can be entered. Change to numerical keyboard by means of the keys 0-9. Once the password has been entered, the system is unlocked at the relevant level for five minutes.

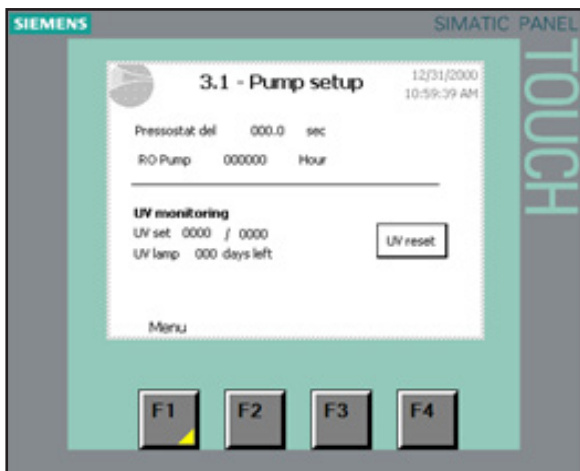

3.1

Pump setup

Pressostat delay preset to 30 sek

Running hours of the RO pump.

UV monitoring only appears if option has been chosen

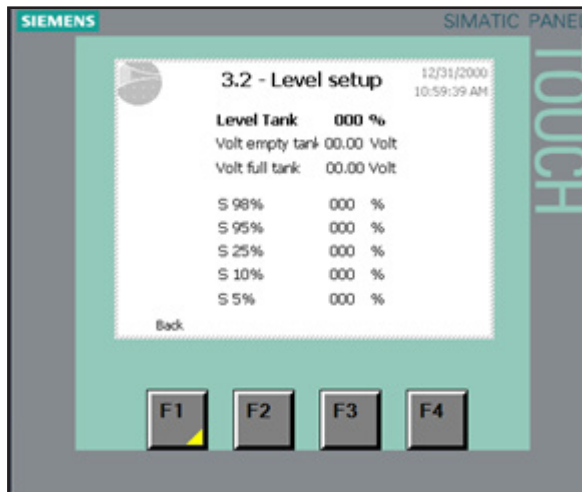

3.2

Do not touch the preset values as this could cause malfunctions and damage to the equipment.

If the ultrasonic level sensor is replaced remember to measure and enter new values for Volt of empty and full tank (measured at the terminals in the control cabinet)



1.0

The Basic setup page provides access to pages and choice of functions:

- Language (press button to toggle between the preinstalled languages)
- General options
- Screen calibration (follow instructions on screen)
- Time/date
- Software version and administration of passwords

Set the screen contrast - / +

***press F3 to go to version and password**

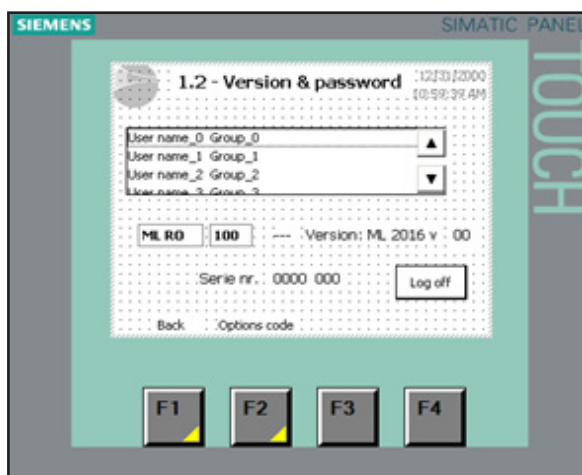

1.2

Check type and size chosen are the same as nameplate on the unit, if not choose correct size in the dropdown menu.

Check Serial number is correct.

If a Modbus or Log option has been acquired press F2 options code

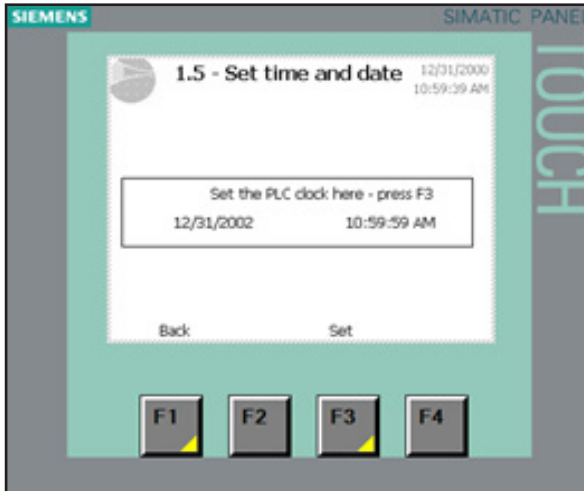

1.5

* set the time and date press F3

4.6 Option setup

If no options has been acquired go to RO flush.

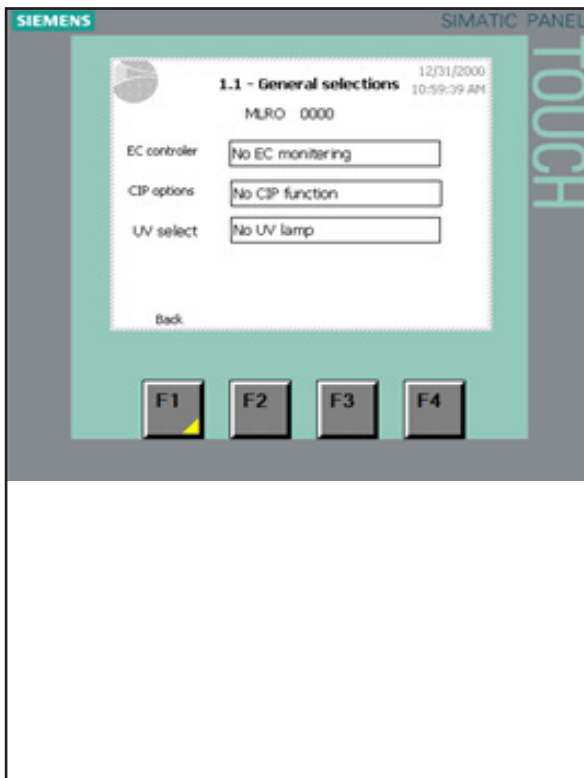

1.1

Select options – be aware that the options here also require hardware changes to the pump station. When an option is chosen the setup button for the option appears on the 3.0 menu page.

EC controller

0 = Without EC option

1 = EC measuring in tank

2 = EC controller (ML EC Reg2/6)

3 = With 1 MixBed and ML EC Reg6

4 = With 2 MixBed and ML EC Reg6

CIP yes / no

UV yes / no (settings appears on 3.1)

*press F1 to go back

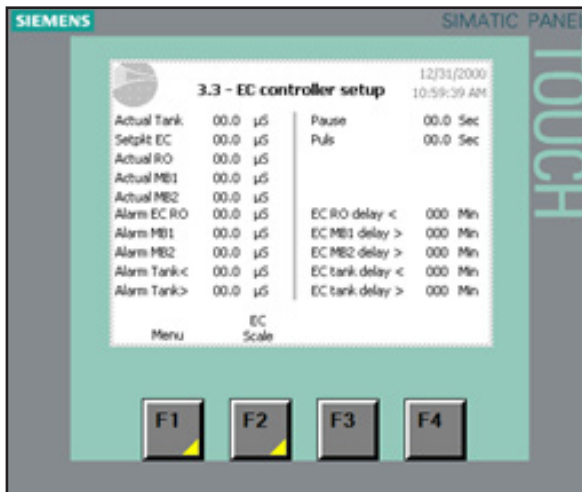

3.3 (Option)

EC controller setup

Setup of alarm limits and alarm delay for the EC alarms (option).

Shows the EC regulation parameters

Please read the EC-REG manual for detailed information

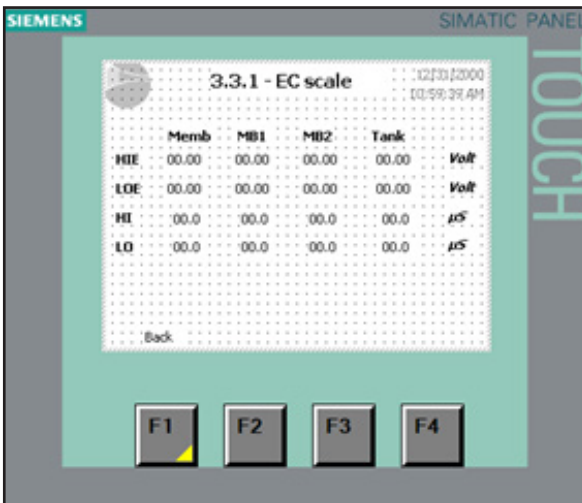

3.3.1 (Option)

EC scale

Parameters for scaling the three optional EC sensors.

Please read the EC-REG manual for detailed information

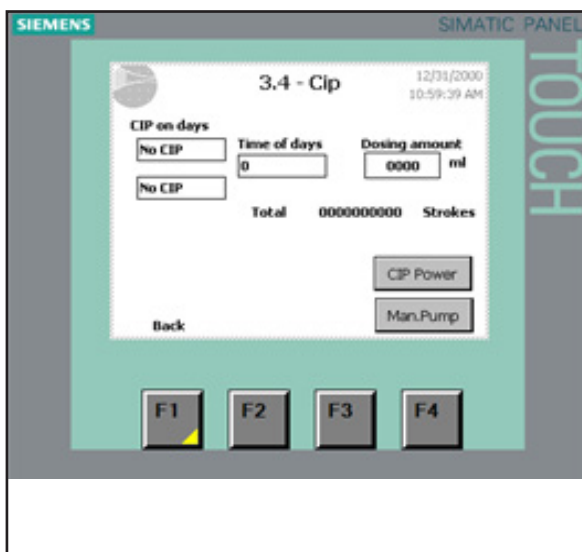

3.4 (Option)

The CIP option will dose a small amount of disinfection (SANOSIL) into the RO tank once or twice per week at a preset time.

Choose days e.g. Monday and Friday

Time of day to CIP e.g. 7 PM

And the CIP dose (see CIP manual)

All choices are made in the dropdown menus.

Please read the CIP manual for detailed information.

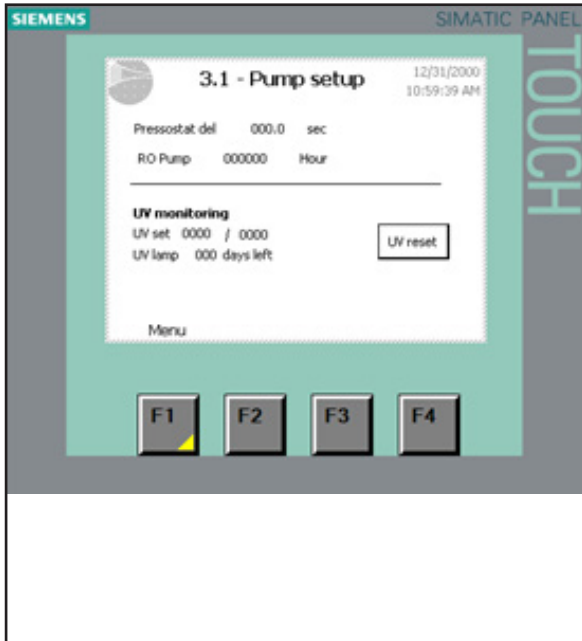

3.1

If the UV option has been selected UV monitoring appears at the 3.1 pump setup screen.

UV set, 0000 / 0000, the value on the right is a measured power value going into the UV lamp, this value will drop if the UV lamp malfunctions. The number on the left has to be adjusted every time the UV bulb is changed. Push the number and put in a value approx. half the value on the right.

When the UV reset button is pushed the 365 day countdown is reset.

4.7 RO membrane flush and startup



The first time a new pump and/or RO membrane is to be used, it is important to flush out any preservation fluids so that they do not end up in the high-pressure system.

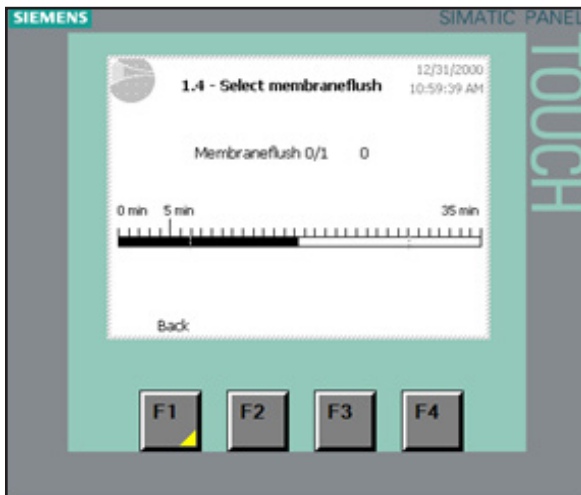

1.4

***From the basic setup screen 1.0 press F1 for membrane flush.**

*tab the 0 and change it to 1

- Normal mode = 0
- Membrane flush = 1 (**remember to put back in normal mode after flushing**).

Turn S1 to 1

RO pump will now start and the flush program will run for 35 minutes.

Check the RO Pumpe is running in the correct direction, if not stop the pump and have the phases sequence changed.

Monitor the pump during flushing.

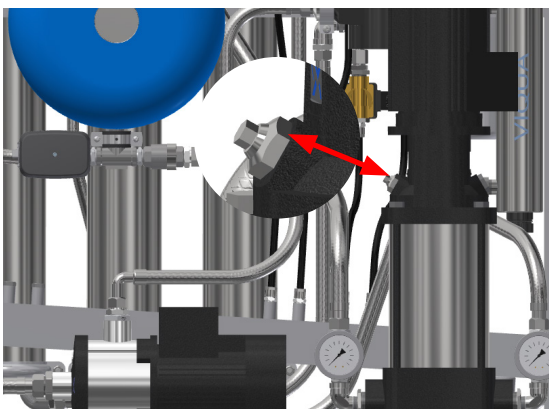

If the RO pump does not build pressure or is noisy, it must be vented.

Open the small centre bleeder screw on the RO pump to fill the pump with water and vent any air. Close the valve again. After a few seconds, the air should be out of the system. If not, repeat the procedure.

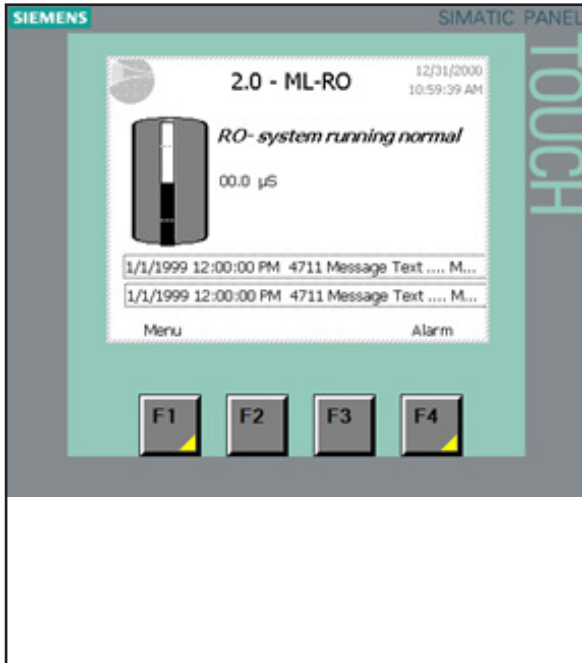

2.0

The RO system is now ready for operation.

NB! Now it's time to adjust the RO, if this is not done before starting the normal operation, the membranes could be damaged.

Normal operation page.

Shows a status line. - The level in the tank is shown in 4 steps (not an linear presentation)

The actual EC in tank is shown (option)

In case an alarm or message is triggered, a bar will appear across the screen showing the message

4.8 Adjusting the reverse osmosis

Explanation of technical terminology

Permeate:

Processed, desalinated water which is produced by the MLR RO system and supplied to the reservoir tank.

Concentrate:

The water led to the outlet. This water contains salts and minerals that have been removed from the water.

Feed water:

The water which is led directly to the ML RO.

TDS:

The amount of dissolved salts, measured in mg/l.

Conductivity:

The designation of the water's salt concentration measured in ($\mu\text{S}/\text{cm}$). The lower the value, the higher the water quality.

Membranes:

Is the system filter which desalinates the feed water using high pressure.

RO:

The abbreviation for reverse osmosis.

Level sensor:

A sensor which emits a signal when the RO system must either be started or stopped, and it stops the transport pump in case of dry running of the reservoir tank.

Softening:

A pre-filter which softens the water, i.e. it removes hardness from the water

4.8.1 Water quality

The feed water, which is to be treated in the ML RO system, must be of drinking water quality. Please read requirements for inlet water in chapter 1 and under product data at the end of this manual.

If there are doubts about the raw water composition, a water analysis must be made. The ML RO must be connected to a water pressure of minimum 2.5 bar and maximum 7 bar. The quality of the treated water will be less than 20 $\mu\text{S}/\text{cm}$ at 10°C.

The ML RO will be adjusted from the factory to the following parameters

ML RO 100 - 300	20 °dH / 10°C	Permeate/concentrate ratio: Approx. 50/50
ML RO 500 - 1500	1 °dH / 10°C	Permeate/concentrate ratio: Approx. 75/25

Water quality (contact Condair for technical advice)		
Content	Symptom	Preventive action
TOC, BOC and COD	Can cause slimy as well as firm hard film.	Can in some cases be micro-filtrated or removed by means of a carbon filter.
Iron, Manganese (ocher)	Precipitation of iron gives a reddish-brown film and precipitation of manganese gives a black deposit.	Sand filter – oxidation, softening, greensand.
Calcium, magnesium (hard water)	The membrane scales.	Softening, antiscalant
Silica	The membrane scales.	Antiscalant.
SDI (silt)	The membranes gets clogged.	Microfiltration (absolute), ultrafiltration, flocculation.
Oil	The membrane is greasy from oil.	Carbon filter.
Particles	The membrane gets clogged due to hard deposits.	Microfiltration.
Chlorine, pesticides, organic solvents	Membrane deformed. Permeate capacity and quality changed and cannot be CIP-cleaned back to the original capacity. The deformation is not visible.	Free chlorine shall be removed by active carbon filter and chemical cleaning, either with thiosulphate or sulphite.
Bacteria	Membrane is clogged by slime.	Chlorination + de-chlorination, UV, micro-filtration 0.2 $\mu\text{S}/\text{cm}$ and ultra-filtration.

4.8.2 Adjustment of outlet amount

Important! Read the entire chapter before adjustment is started

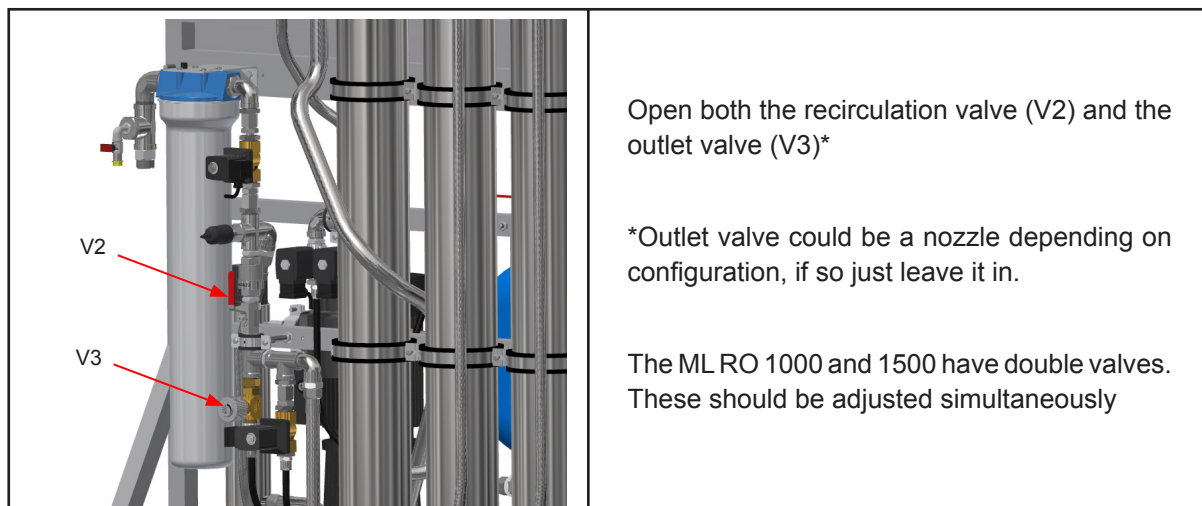

The outlet (concentrate) amount must be adjusted. Which amount is suitable on your system depends on the feed-water quality. Too high water recovery will damage the system membranes. On condition that the raw water complies with the water quality requirements, it can operate at a recovery rate of 70-80% with softening depending on the amount of organic material in the water.

ML RO type	Max Permeate capacity (l/h)*	Outlet amount (l/h) (with softened water)		Outlet amount (l/h) (with tap water)	
		Surface water (75% recovery)	Groundwater (80% recovery)	Surface water (50% recovery)	Groundwater (55% recovery)
100	100	33	25	100	82
300	275	92	69	275	225
500	500	167	125	-**	-**
800	750	250	188	-**	-**
1000	1000	335	250		
1500	1500	500	375		

- * For every degree the inlet water is below 10°C, the permeate capacity (l/h) must be adjusted down with 3%.
- ** We recommend always using softening from ML RO 500 and upward, as the water consumption and wear on membranes will be relatively high. However, local water conditions may in some cases justify running without. Please ask Condair for advice.

Ex.: ML RO 500 with 80% recovery

$$\text{Outlet amount l/h} = \frac{100 \times \text{Permeate capacity l/h}}{\text{Recovery\%}} - \text{Permeate capacity l/h}$$

$$\text{Outlet amount} = \frac{100 \times 500}{80} - 500 = 167 \text{ l/h}$$

Start the RO system and adjust the outlet so the desired amount of outlet water has been obtained.

4.8.3 Adjustment of permeate amount

Adjust the permeate amount at the recirculation valve. Adjust the amount of permeate produced to Max Permeate capacity (l/h) of the specific system, remember to temperature withdraw 3% from Max Permeate capacity (l/h) for every degree the inlet water is below 10°C.

E.g. if the feed water temperature is 8°C, for an ML RO 300 it means that the permeate capacity will be 6% below the normal 275 l/h, i.e. 258 l/h.

When the requested pressure and permeate capacities have been obtained, check again if the outlet amount has been adjusted correctly.

NB! The system must be started and stopped two times, and then the flow must be re-checked. The valves can then be readjusted if necessary.

Check on the RO pump outlet manometer that it shows the correct operating pressure, 6-10 bar. Please note that the operating pressure may vary by different temperatures and capacities.

Now check the quality of the processed water on the permeate hose; the conductivity must be below 20 µS/cm (conductivity meter is available as optional equipment).

Check that the outlet water is below 1000 µS/cm

Check that the ML RO automatically starts and produces treated water.

Check if the ML RO automatically shuts down by too low feed water pressure or lacking feed water supply. This is done by slowly closing the feed water supply while the ML RO is in operation. When the water supply has been interrupted, the ML RO must stop automatically within 10 sec. In order to put the ML RO back into operation, the water supply must be re-established and the reset button pushed once. The ML RO will automatically revert back to normal operation! The system is now commissioned and ready for use

5 Operation

Persons operating the ML RO's controller must have read and understood this manual. Knowing and understanding the contents of the manual is a basic requirement for protecting the personnel against any kind of danger, to prevent faulty operation and to operate the unit safely and correctly.

All safety notes in the installation and operation manual for the ML RO must be observed and adhered to. All work described in this controller manual may only be carried out by properly trained personnel which is authorised by the customer.

If you have questions after reading this documentation, please contact your Condair representative who will be happy to assist you.

5.2 Overview cabinet

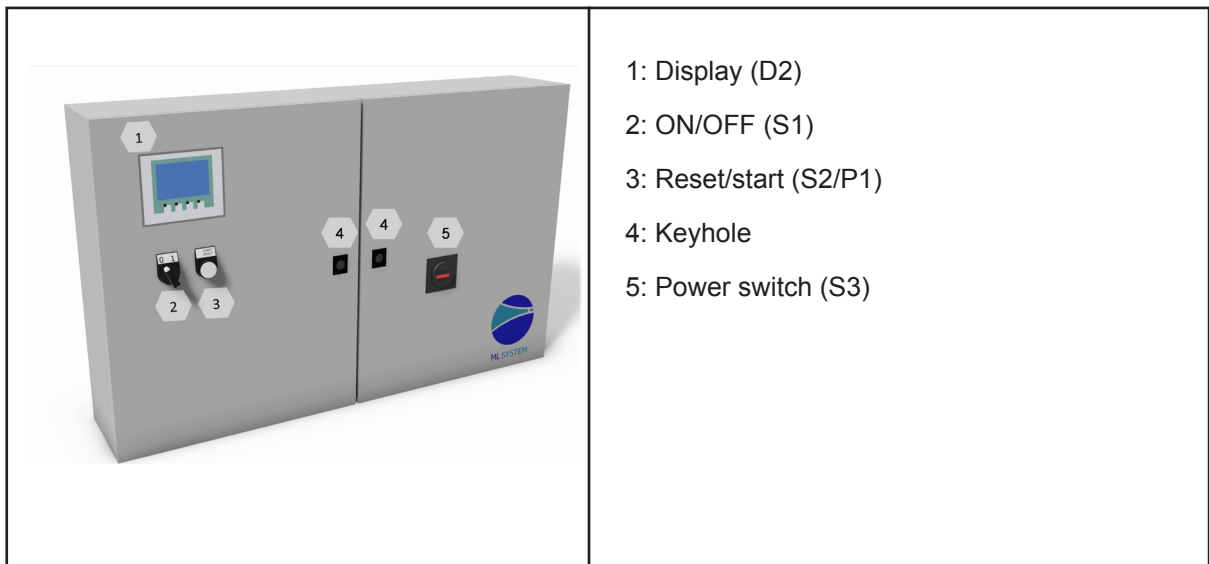

5.1 Equipment protection

Pressure switch (inlet water)

The ML RO has a pressure switch which monitors the inlet water pressure.

If the inlet water pressure drops, the controller will stop the pump, thus protecting it against dry running. If the water pressure drops, the screen will display 'PM Water pressure too low'.

Thermal motor relay

Both electrical motors are protected against overheating by a thermal motor relay

Description of touch screen

The screen has four F keys. Each of the keys are used to navigate between the different screen images. When these are used, the individual key function is indicated in the description directly above the key.

The touch screen can be operated by gently tapping the relevant screen 'buttons' with your finger.

To change a numerical value tap the value on the touch screen, this will make the numerical keyboard pop-up and the new value can be entered. Hit enter to save.

Protection against unwanted changes

The control unit settings are password-protected against unwanted changes. The different user groups have different passwords and different rights.

User (no password) can read operational information and alarms.

User 1 (password 1234) as above + changing of set points.

Technician (password 197) as above + changing of operational parameters and choice of membrane rinse.

Master (password 8599) as above + selectable options.

Condair tech xxxx, as above + factory / service menu.

When a password is required in order to change parameters, a screen will appear where the password can be entered. Parameters can be changed using the numerical keyboard (keys 0-9).

Once the password has been entered, the system is unlocked at the relevant level for five minutes.

5.3 Alarm message

This page shows alarms and operational messages. The alarm display contains information about when an alarm was triggered and when it was reset. The page shows active alarms and previous alarms. Please note that the system does not have a backup memory, which means that previous alarms will be lost in case of power failure.

Water pressure too low

The water pressure on the water inlet to the pump station is too low. The alarm triggers if the sensor detects water pressure lower than 0,5 bar.

Tank Full

The water level in the tank is too high – lower the water level and reset the system. Check that the inlet valve MV1 closes tightly when the system is idle.

CIP overdosing last day (option)

The CIP self-monitoring system has detected a possible overdosing. Please call for service

EC too high after mixedbed

EC too high RO membrane

Water quality – EC to low

Water quality – EC to high

Add on BOX EC reg error

The box detected does not match the chosen box

Add on BOX CIP error

The box detected does not match the chosen box

Add on BOX EC comm.error

Network error, check power to Add on box and network cables

Add on BOX CIP comm.error

Network error, check power to Add on box and network cables

Operational message display (Warnings)

CIP pump error (option)

General pump error.

CIP to low dosing (option)

Possible under dosing of CIP fluid detected, check CIP bottle and for air in the system

UV lamp error (option)

There is an error on the UV lamp

UV lamp getting old (option)

21 days to recommended renewal of the UV bulb

UV lamp error too old

Replace UV lamp and reset service interval

Water level below start level

The water level in the tank is too low for the transfer pump to start. Once an adequate level has been reached, the system will start automatically.

Mixedbed 1 must be changed

5.4 Controller menu

5.4.1 Start page - basic settings

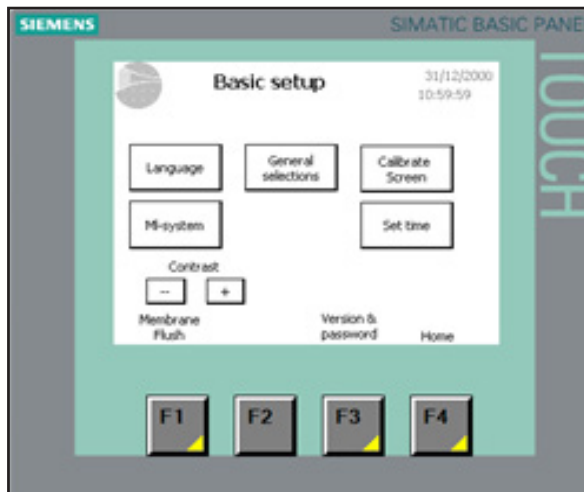

Basic setup

The Basic setup page provides access to pages and choice of functions:

- Language
- General options
- Screen calibration
- Time/date
- Software version and administration of passwords

Once these choices have been made, press OK to continue.

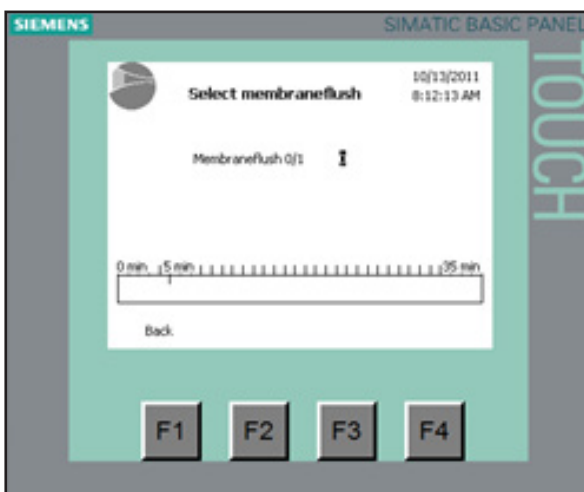

Choose whether membrane flush has to be used.

2 – Waiting for a selection to be made.

1 – Run flush of RO membranes (takes at least 35 min.).

0 – Run normal operation.

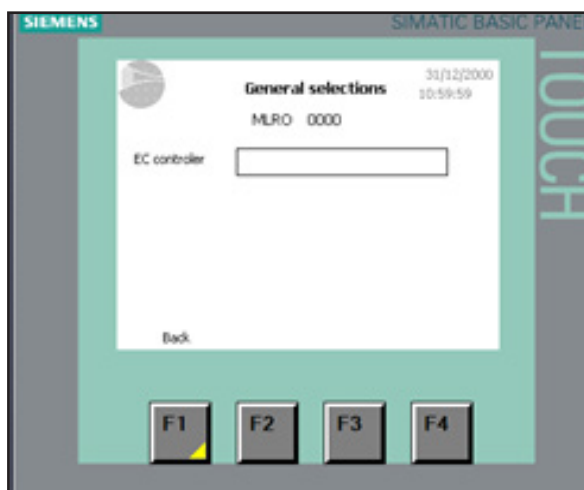

Select options – be aware that the option also requires hardware changes to the pump station.

EC controller

0 = Without EC option

1 = EC measuring in tank

2 = EC controller (ML EC Reg2/6)

3 = With MixBed and ML EC Reg6



Time and date can be set.

Then press F3

5.4.2 Operation and menu page

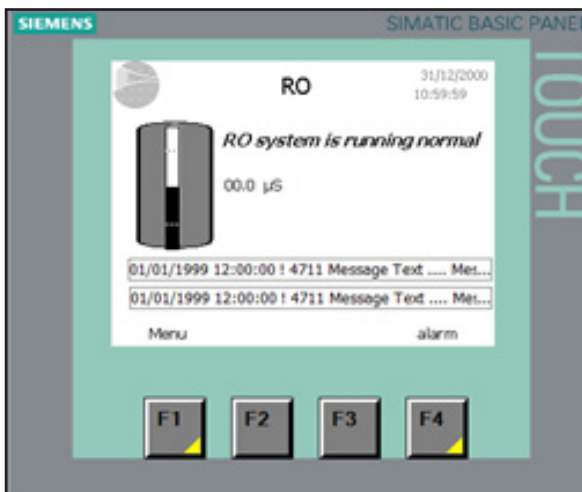

Normal operation page

Shows a status line. - The level in the tank is shown in 4 steps (not an analog presentation)

The actual EC in tank is shown (option)

In case an alarm or message is triggered, a bar will appear across the screen showing the message.

Access to the menu page – the alarm page.

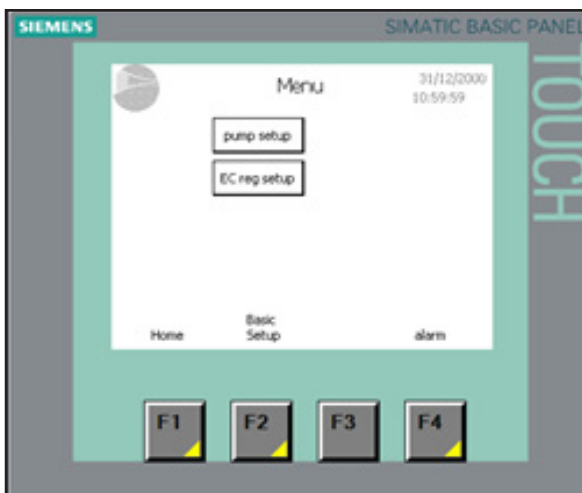

Menu page

Gives access to the pump setup and to the EC regulator setup (option).

And access back to the Basic setup

5.4.3 Alarm messages

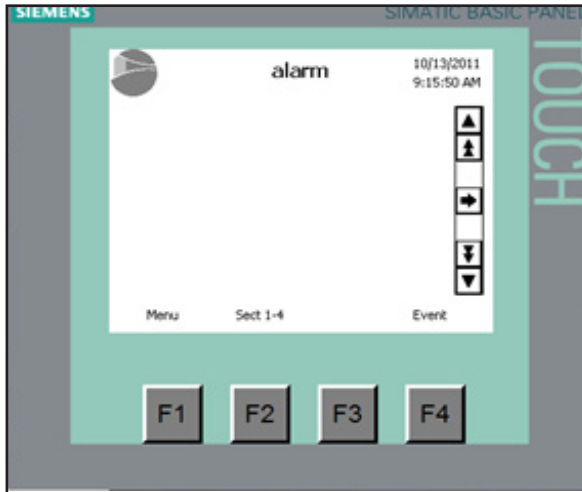

All alarms and operational messages are shown with the time at which they occurred and the time when the alarm stopped.

Please note that the alarm log will be reset after a power cut.

5.4.4 Pump setup



Pump alarm settings

Pressostat delay

Hour counters for the pumps show the total running time.

5.4.5 Pages for the EC monitoring and regulation (option)

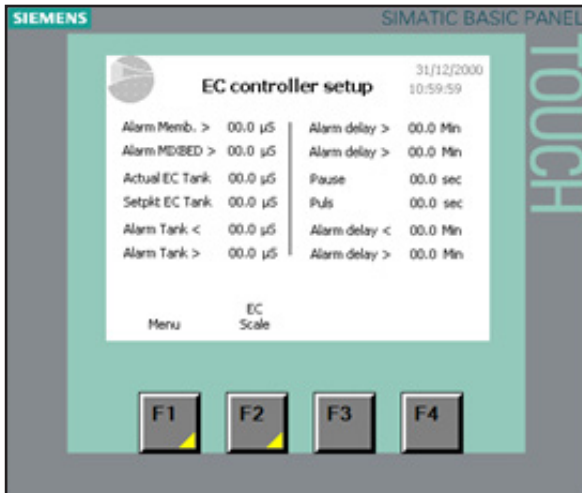

EC controller setup

Setup of alarm limits and alarm delay for the EC alarms (option).

Shows the EC regulation parameters.

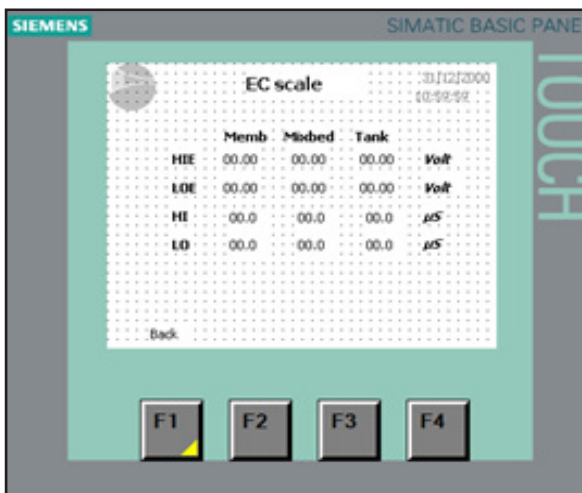

EC scale

Parameters for scaling the three optional EC sensors.

5.5 Weekly inspection

During operation, the ML RO and the humidification system have to be inspected weekly. On this occasion, check the following:

- Entire system for leakage
- Electric installation for damage
- Operating display for warning or error messages
- UV filters
- Pressure drop over inlet filter
- Water treatment systems such as carbon filter, softener

If the inspection reveals any irregularities (e.g. leakage, error indication) or any damaged components take the ML RO out of operation. Have a qualified specialist or Condair service technician correct the damage or malfunction.

Fill in the 'Service form for weekly monitoring of humidifying systems' provided in the Appendix of this manual. Failing to do so could affect your warranty.

6 Weekly inspection

6.1 Important notes on maintenance

Qualification of personnel

All maintenance work must only be carried out by qualified and trained personnel authorized by the owner. Maintenance and repair of the electrical installation of the ML RO must only be carried out by qualified personnel (e.g. electrician) who are aware of possible dangers and implications. It is the owner's responsibility to verify proper qualifications of the personnel.

General note

The instructions and details for maintenance work must be followed.

Only maintenance work described in this documentation may be carried out. Use only original ML-System spare parts to uphold the system warranty.

Safety

Before maintenance is initiated, the ML RO must be taken out of operation in accordance with instructions in the section 'Taking the ML RO out of operation'. Protect the system against unintentional switch-on. The ML RO must be serviced at the intervals described in this manual and cleaning and disinfection must be performed by trained and instructed personal.



A poorly maintained RO system may endanger health if used to supply an adiabatic humidification system. Therefore it is mandatory to observe the specified maintenance intervals and to carry out maintenance and cleaning in strict accordance with the instructions.

6.2 Maintenance work

To ensure safe, hygienic and economic operation of the ML RO, vital components must be checked and maintained periodically according to the table below. The maintenance intervals and maintenance work stated below are guideline values. Local conditions, quality of the water, etc. could influence the maintenance intervals. After having carried out the maintenance work, fill in the maintenance checklist, sign it and reset any maintenance indications. The relevant personnel is responsible for any maintenance work not carried out.

Service, to be carried out	Half year	Each year	Every 2 years	Every 4 years
Review of the system				
Testing of the system's overall function	X	X	X	X
Meter reading of water consumption (if present)	X	X	X	X
Reading of pump running hours	X	X	X	X
Logbook registration	X	X	X	X
Controle weekly monitoring checklist	X	X	X	X
Analysis of water hardness (in case of water softening)	X	X	X	X
Pump unit				
Replacement of filter(s)	X	X	X	X
Check the condition of the pump (pressure & noise)	X	X	X	X
Testing of solenoid valves and replacement if necessary	X	X	X	X
Check Hydro membrane pressure, and adjust to 1 bar if necessary. Make sure the membrane is not punctured.	X	X	X	X
Functional testing of pressure gauge	X	X	X	X
Functional testing of pressure switch (pressostat)	X	X	X	X
Testing of ON/OFF valve and replacement if necessary	X	X	X	X
Reverse osmosis systems/RO				
Measurement of conductivity at inlet, outlet and drain	X	X	X	X
Testing of overall function and settings for the RO system	X	X	X	X
Leak testing	X	X	X	X
Performance test (vol. produced water compared to drain water)	X	X	X	X
Testing of valves	X	X	X	X
Replacement of sterile breather filter		X	X	X
Evaluation of membrane, replacement if necessary	X	X	X	X
Disinfection / cleaning of tank	X	X	X	X
UV system				
Functional testing of UV systems	X	X	X	X
Cleaning of quartz glass on UV systems	X	X	X	
Replacement of UV-lamp		X	X	X
Replacement of quartz glass				X
Control units				
Transfer relay replacement		X	X	X
Testing of contact K1 and replacement if necessary		X	X	X
Hygiene				
Extraction of water sample from pump (Bacterie test)	X	X	X	X
Desinfection/cleaning of the system	X	X	X	X

6.3 Preventive spare parts chart

Defined preventive replacement of spare parts in connection with service													
Service	Designation	Part number	MLR0100	MLR0300	MLR0500	MLR0800	MLR01000	MLR01500	Technical lifetime	Service B every (1/2) year	Service C every (1st) year	Service D every (2end) year	Service E every (4th) year
Water filter													
Filter 5 micron 20"	104551000	1cde 1bcde 1bcde 1bcde 1bcde 2bcde	1cde	1cde	1cde	1cde	1cde	1cde	6 months	Change	Change	Change	Change
O-ring for water filter	430020050	1cde	1cde	1cde	1cde	1cde	1cde	1cde	24 months	Check	Check	Change	Change
Air Filter													
Sterile breather filter 0.2 my	104581000	1cde 1cde 1cde 1cde 1cde 1cde	1cde	1cde	1cde	1cde	1cde	1cde	12 months	Check	Change	Change	Change
UV Filter													
19 W S2Q-PA/2 light pipe	104595000	1cde 1cde 1cde	1cde	1cde	1cde	1cde	1cde	1cde	12 months	Check	Change	Change	Change
26 W S5Q-PA/2 light pipe	104596000	1cde	1cde	1cde	1cde	1cde	1cde	1cde	12 months	Check	Change	Change	Change
39 W S8Q-PA/2 light pipe	104597000	1cde	1cde	1cde	1cde	1cde	1cde	1cde	12 months	Check	Change	Change	Change
Quarts UV System													
19 W QS-330 Quarts	104583000	1e 1e 1e	1e	1e	1e	1e	1e	1e	48 months	Check	Check	Check	Change
26 W QS-463 Quarts	104584000	1e 1e	1e	1e	1e	1e	1e	1e	48 months	Check	Check	Check	Change
39 W / 46 W QS-810 Quarts	104586000	1e	1e	1e	1e	1e	1e	1e	48 months	Check	Check	Check	Change
RO membrane													
4" for MLPRO: $\mu\text{S} < 250$	150460000	1e 1e 1e 1e 1e 1e	1e	1e	1e	1e	1e	1e	95%	Check	Check	Check	Check
2.5" for MLPRO: $\mu\text{S} < 250$	150465000	1e	1e	1e	1e	1e	1e	1e	95%	Check	Check	Check	Check
4" for MLPRO: $\mu\text{S} > 250$	686020010	1e 1e 1e 1e 1e 1e	1e	1e	1e	1e	1e	1e	95%	Check	Check	Check	Check
2.5" for MLPRO: $\mu\text{S} > 250$	686020005	1e	1e	1e	1e	1e	1e	1e	95%	Check	Check	Check	Check
Electrical control system													
Print frame relay	680010177	1cde 1cde 1cde 1cde 1cde 1cde	1cde	1cde	1cde	1cde	1cde	1cde	12 months		Change	Change	Change
Contaktor (K1) Siemens	349010205	1e 1e 1e 1e 1e 1e	1e	1e	1e	1e	1e	1e	48 months		Check	Check	Change
On/off valve													
On/off valve	106521000	1e 1e 1e 1e 1e 1e	1e	1e	1e	1e	1e	1e	48 months	Check	Check	Check	Overhaul
Water sample													
Water sample	155605000	2bcde								Use for Service	Use for Service	Use for Service	Use for Service

6.4 Weekly check list

Service form for weekly monitoring of ML RO	Function of softner Hardness test																				
	Testing salt level during softening																				
	Difference ΔP (Manometer 1-2)																				
	Manometer 2																				
	Manometer 1																				
	Reading/messuring of conductivity $\mu S/cm$ brine																				
	Reading/measuring of conductivity $\mu S/cm$ permate																				
	Reading/measuring of conductivity $\mu S/cm$ inlet																				
	Reading of hour meter hours																				
	Reading of water meter m^3																				
	Initial																				
	Date																				

6.5 Troubleshooting

6.5.1 Qualification of personnel

Have faults eliminated by qualified and trained personnel only. Malfunctions caused by the electrical installation must only be repaired by authorised personnel (e.g. electrician).

6.5.2 Safety

When working on the system, the ML RO must be taken out of operation and prevented from further inadvertent operation.

Make sure the power supply to the ML RO is disconnected and that the water supply is cut off.

Error message	Cause	Remedy
Tank full	Tank maximum level / overflow has been detected	RO pump running? Check if the motor start relay is jammed
	Inlet valve [MV1] leaks.	Change / repair valve
	Level sensor error	Check setting in the software is correct for the tank size. Replace level sensor
Inlet water pressure too low	The inlet water pressure is too low (below 0.5 bar at sensor) or inlet filter clogged	Check the inlet pressure at maximum flow is sufficient according to specs. Change inlet filter
	The Inlet water pressure is too low for short periods (if inlet pressure and flow seems ok when measured)	Check the water installation for periodically high consumption e.g. cleaning, tank filling and maintenance work
	Defect inlet pressure switch [PS]	Replace pressure switch

Error message	Cause	Remedy
EC too high after mix-bed	The selected alarm limit is reached	Mixed bed filter full, change filter
		Alarm limit set incorrectly (screen 3.3) Alarm Delay too short
		EC scaling needs to be done (screen 3.3.1)
EC too high RO membrane	The selected alarm limit is reached	Membrane warn or RO loop needs to be adjusted
		Alarm limit set incorrectly (screen 3.3) Alarm Delay too short
		EC scaling needs to be done (screen 3.3.1)
Water quality – EC too low or too high	The selected alarm limit is reached	Alarm limit set incorrectly (screen 3.3)
		EC scaling needs to be done (screen 3.3.1)
CIP overdosing last day	Self-monitoring system detects the CIP pump has been running too much in 24 hours cycle	Press reset and check CIP pump for errors.
CIP pump error	General error detected	Air the CIP-pump, listen for noise and check pressure

Error message	Cause	Remedy
CIP pump low dosing	Insufficient CIP volume detected	Check / refill CIP fluid Air the CIP-pump
UV lamp error	UV-Bulb or power supply error	Replace UV-bulb
		Check/replace power supply/transformer
UV lamp getting old	Less than 3 weeks to UV lamp should be serviced	Plan service Reset timer
UV lamp too old	Time to service UV lamp	Service the UV lamp according to guide
Add On box EC-reg error	The choices made in the controller does not match the box detected in the network	Change setting in controller
Add On box CIP error	The choices made in the controller does not match the box detected in the network	Change setting in controller
Add On box (EC or CIP) common error	Lost communication to add on box	Power to EC box disconnected
		Network cable to EC box disconnected

6.5.3 Resetting the error indication

Press the reset button underneath the touch screen.

Note: If the fault has not been eliminated, the error indication reappears after a short while.

6.5.4 Resetting the error indication

Error message	Cause	Remedy
<p>Control unit is switched on but the display does not show anything.</p>	Main power supply is off.	Switch power on.
	Fuses of the power supply line blown	Have an electrician replace fuses of the power supply line
	Fuse of control unit blown	Have an electrician replace fuse of the control unit.
	Display or control board defective	Have a Condair service technician replace the display or the control board
	Thermal motor protection relay activated	Motor overheated, pump damaged/blocked, check pump is running freely. Check power consumption at full load corresponds to motor specs

7 Product data

Preconditions	MLRO 100	MLRO 300	MLRO 500	MLRO 800	MLRO 1000	MLRO 1500	MLRO 2000	MLRO 3000
Water supply	Drinkingwater quality, 2.5-7 bar @200 l/h	Drinkingwater quality, 2.5-7 bar @600 l/h	Drinkingwater quality, 2.5-7 bar @700 l/h	Drinkingwater quality, 2.5-7 bar @1100 l/h	Drinkingwater quality, 2.5-7 bar @1400 l/h	Drinkingwater quality, 2.5-7 bar @2100 l/h	Drinkingwater quality, 3- 7 bar @2800 l/h	Drinkingwater quality, 2.5-7 bar @4500 l/h
Hardness	max. 20 °dH	max. 20 °dH	max. 1 °dH	max. 1 °dH	max. 1 °dH	max. 1 °dH	max. 1 °dH	max. 15 °dH
Conductivity (µS/cm)	250-1000	250-1000	250-1000	250-1000	250-1000	250-1000	250-1000	150-750
Free chlorine	max. 0.1 mg/l	max. 0.1 mg/l	max. 0.1 mg/l	max. 0.1 mg/l	0.1 mg/l	0.1 mg/l	0.05 mg/l	0.05 mg/l
TDS	max. 625 mg/l	max. 625 mg/l	max. 625 mg/l	max. 625 mg/l	max. 625 mg/l	max. 625 mg/l	< 1000 mg/l	max. 625 mg/l
Silt index	max. 3	max. 3	max. 3	max. 3	max. 3	max. 3	max. 3	max. 3
KMnO4	max. 10 mg/l	max. 10 mg/l	max. 10 mg/l	max. 10 mg/l	max. 10 mg/l	max. 10 mg/l	max. 10 mg/l	max. 10 mg/l
Fe	max. 0.2 mg/l	max. 0.2 mg/l	max. 0.2 mg/l	max. 0.2 mg/l	max. 0.2 mg/l	max. 0.2 mg/l	max. 0.2 mg/l	max. 0.2 mg/l
Mn	max. 0.05 mg/l	max. 0.05 mg/l	max. 0.05 mg/l	max. 0.05 mg/l	max. 0.05 mg/l	max. 0.05 mg/l	max. 0.05 mg/l	max. 0.05 mg/l
NTU	max. 1.0	max. 1.0	max. 1.0	max. 1.0	max. 1.0	max. 1.0	max. 1.0	max. 1.0
Temperature Recommended	15°C	15°C	15°C	15°C	15°C	15°C	15°C	15°C
Temperature Max.	max. 40°C	max. 40°C	max. 40°C	max. 40°C	max. 40°C	max. 40°C	max. 40°C	max. 40°C

Specifications	MILRO 100	MILRO 300	MILRO 500	MILRO 800	MILRO 1000	MILRO 1500
Capacity, (Inlet water temp 15°C)	100 l/h	275 l/h	500 l/h	750 l/h	1000 l/h	1500 l/h
Permeate quality (µS/cm)	5 < EC < 30	5 < EC < 30	5 < EC < 30	5 < EC < 30	5 < EC < 30	5 < EC < 30
Permeate/Concentrate ratio	approx. 50 / 50 %	approx. 50 / 50 %	approx. 75 / 25 %	approx. 75 / 25 %	approx. 75 / 25 %	approx. 75 / 25 %
Reservoir tank, liters	50	50	200	500	500	500
Size, frame (LxWxH) mm	860 x 700 x 1600	860 x 700 x 1600	860 x 700 x 1600	860 x 700 x 1600	1400 x 700 x 1600	1400 x 700 x 1600
Size, reservoir tank (LxWxH) mm			600 x 600 x 1540	790 x 790 x 1400	790 x 790 x 1400	790 x 790 x 1400
Weight, pumpstation kg	110	115	220	250	270	320
Weight, tank					39	39
Sound pressure level, dB(A)	< 75	< 75	< 80	< 80	< 80	< 75
Supply voltage	3x400 VAC+GDN+N, 50Hz, 1,6KW, 16A	3x400 VAC+GDN+N, 50Hz, 2,1KW, 16A	3x400 VAC+GDN+N, 50Hz, 2,1KW, 16A	3x400 VAC+GDN+N, 50Hz, 2,1KW, 16A	3x400 VAC+GDN+N, 50Hz, 3,1KW, 16A	3x400 VAC+GDN+N, 50Hz, 3,1KW, 16A
	3x230 VAC+GDN+N, 50Hz, 1,6KW, 16A	3x230 VAC+GDN+N, 50Hz, 2,1KW, 16A	3x230 VAC+GDN+N, 50Hz, 2,1KW, 16A	3x230 VAC+GDN+N, 50Hz, 2,1KW, 16A	3x230 VAC+GDN+N, 50Hz, 3,2KW, 16A	3x230 VAC+GDN+N, 50Hz, 3,2KW, 16A
	3x208 VAC+GDN+N, 60Hz, 1,4KW, 16A	3x208 VAC+GDN+N, 60Hz, 1,8KW, 16A	3x208 VAC+GDN+N, 60Hz, 1,8KW, 16A	3x208 VAC+GDN+N, 60Hz, 1,8KW, 16A	3x208 VAC+GDN+N, 60Hz, 2,6KW, 16A	3x208 VAC+GDN+N, 60Hz, 2,6KW, 16A
Dissolved salt removal	> 95%	> 95%	> 95%	> 95%	> 95%	> 95%
Water connection, tap water	3/4" RG	3/4" RG	3/4" RG	3/4" RG	G 3/4"	G 3/4"
Water connection, RO-water	3/4" RG	3/4" RG	3/4" RG	3/4" RG	G 3/4"	G 3/4"
Water connection, drainage	3/4" RG	3/4" RG	3/4" RG	3/4" RG	G 3/4"	G 3/4"
Outgoing pressure, RO-water	3.0-4.2 bar	3.0-4.2 bar	3.0-4.2 bar	3.0-4.2 bar	3.0-5.0 bars	3.0-4.2 bars

8 Declaration of conformity



EC - Declaration of Compliance

Manufacturer:

Condair A/S
Parallelvej 2
8680 Ry

We hereby declare, that the following pump systems for humidification purposes:

ML RO 100; ML RO 300; ML RO 500; ML RO 800; ML RO 1000; ML RO 1500;
HP 100; HP 200 VFD; HP 300; HP 500; HP 500 VFD; HP 800; HP 800 VFD; HP 1300 VFD
HP RO 100; HP RO 200 VFD; HP RO 300; HP RO 500; HP RO 500 VFD; HP RO 800; HP RO 800 VFD
MLP 100; MLP 300; MLP 500; MLP 800; MLP 1000; MLP 2x800; MLP 2x1000; MLP 3x800; MLP 3x1000
MLP RO 100; MLP RO 300; MLP RO 500; MLP RO 800
MLP HRO 100; MLP HRO 300
MLPD 300; MLPD 500; MLPD 1000;
MLPG 100; MLPG 300; MLPG 500; MLPG 800; MLPG 1000;

are manufactured in accordance with the following EC directives:

- 2006/42/EC, Directive on machinery
- 2014/30/EC, EMC (ElectroMagnetic Compatibility) Directive
- 2014/35/EC, The low voltage directive
- 2011/65/EC, ROHS Directive on the restriction of the use of certain hazardous substances in electrical and electronic equipment.

The following harmonized standards have been applied:

- EN ISO 12100:2011, Safety of machinery – General principles for design – Risk assessment and risk reduction
- EN ISO 13849-1:2008, Safety of machinery – Safety-related parts of control systems – Part 1: General principles for design.
- EN 55022:2011+AC, Information technology equipment – Radio disturbance characteristics – Limits and methods of measurement
- EN 60204-1:2006 + amendments, Safety of machinery – Electrical equipment of machines – Part 1: General requirements

The following international standards and technical specifications are used:

- IEC 60034-1 ed. 12.0, Rotating electrical machines - Part 1: Rating and performance
- IEC 60034-5 ed. 4.1, Rotating electrical machines - Part 5: Degrees of protection provided by the integral design of rotating electrical machines (IP code) – Classification
- IEC 60034-6 ed. 2.0, Rotating electrical machines - Part 6: Methods of cooling (IC Code)
- IEC 60034-8 ed. 3.1, Rotating electrical machines - Part 8: Terminal markings and direction of rotation
- IEC 60320 ed. 2.1, Appliance couplers for household and similar general purposes - Part 1: General requirements

DK-Ry, November 26, 2015



Lasse Andresen, Technical Manager

Condair A/S
Parallelvej 2, DK-8680 Ry
Tel. +45 8788 2100
www.condairsystems.dk

9 Appendices

MODBUS communication TCP/IP

ML-System humidification controls with PLC control is available with an option that allows connection to CTS / BMS systems via Modbus TCP / IP.

The physical connection is made with a standard Ethernet cable that connects the PLC controller with a standard RJ45 connector.

The option includes changes in the software, and a list of setup and the addresses of parameters to be transferred between the PLC system and CTS / BMS.

The connection gives actual humidity for each section and general information about the system status. And it is possible to change setpoint from the BMS system. In addition, there is also a current "status" integer that describes the plant's operational status so alarms can be transferred to the BMS.

The modbus TCP / IP connection is set up with ML-System's PLC as Server/(slave) – and the BMS as a client/(master).

IP PLC: 192.168.135.220 mask 255.255.255.0
 Connect ID 1
 Port 502
 MB Data addresser 40001 – 40033
 Dataformat Integer (int)

Setpoint 1	R	Integer	40001	%RH
Setpoint 2	R	Integer	40002	%RH
Setpoint 3	R	Integer	40003	%RH
Setpoint 4	R	Integer	40004	%RH
Setpoint 5	R	Integer	40005	%RH
Setpoint 6	R	Integer	40006	%RH
Setpoint 7	R	Integer	40007	%RH
Setpoint 8	R	Integer	40008	%RH
Setpoint 9	R	Integer	40009	%RH
Setpoint 10	R	Integer	40010	%RH
Setpoint 11	R	Integer	40011	%RH
Setpoint 12	R	Integer	40012	%RH
Humidity 1	W	Integer	40013	%RH
Humidity 2	W	Integer	40014	%RH
Humidity 3	W	Integer	40015	%RH
Humidity 4	W	Integer	40016	%RH
Humidity 5	W	Integer	40017	%RH
Humidity 6	W	Integer	40018	%RH
Humidity 7	W	Integer	40019	%RH
Humidity 8	W	Integer	40020	%RH
Humidity 9	W	Integer	40021	%RH

Humidity 10	W	Integer	40022	%RH
Humidity 11	W	Integer	40023	%RH
Humidity 12	W	Integer	40024	%RH
Tank level	W	Integer	40025	%
Actual flow	W	Integer	40026	l/h (lb/h)
EC Ro	W	Integer	40027	µS
EC MB1	W	Integer	40028	µS
EC MB2	W	Integer	40029	µS
EC tank	W	Integer	40030	µS
Status mode	W	Integer	40031	
On/Off	W	Bool	40032.1	
alarm general	W	Bool	40032.2	
Level in tank ok	W	Bool	40032.3	
Water pressure low	W	Bool	40032.4	
Pump overheated	W	Bool	40032.5	
Pump2 overheated	W	Bool	40032.6	
tank overfull	W	Bool	40032.7	
UV error	W	Bool	40032.8	
UV age warning	W	Bool	40032.9	
UV age alarm	W	Bool	40032.10	
Sensor error	W	Bool	40032.11	
MaxHyg error	W	Bool	40032.12	
Cip Alarm	W	Bool	40032.13	
EC RO alarm	W	Bool	40032.14	
EC MB1 alarm	W	Bool	40032.15	
EC MB2 alarm	W	Bool	40032.16	
EC tank high alarm	W	Bool	40033.1	
EC tank low alarm	W	Bool	40033.2	
Too many pump stopped	W	Bool	40033.3	
Internal setpoint	W	Bool	40033.4	
Not used	W	Bool	40033.5	
Not used	W	Bool	40033.6	
Not used	W	Bool	40033.7	
Not used	W	Bool	40033.8	
Not used	W	Bool	40033.9	
Not used	W	Bool	40033.10	
Not used	W	Bool	40033.11	
Not used	W	Bool	40033.12	
Not used	W	Bool	40033.13	
Not used	W	Bool	40033.14	
Not used	W	Bool	40033.15	
Not used	W	Bool	40033.16	

Water softener MACH 2030, 2060, 2100 & CP 213S

A. Installation instructions

1. Remove the cardboard packaging from the individual parts.
2. The system consists of two filters, a salt reservoir, drain/salt hoses as well as connecting pieces incl. O-rings and silicone.



3. Fit the enclosed O-rings on the black plastic/brass connecting pieces and lubricate with silicone from the small tube. Then install the connecting pieces shown in the pictures below.



4. Make sure there are no mechanical impurities following the installation work. If necessary, flush the pipework before installing the system.
5. Install the drain hose on the head of the water softener in the associated drain connector and tighten the nut by hand, see below.



1. Outlet, soft water
2. Inlet, raw water
3. Tube for floor drain (thick, transparent)
4. Tube for salt reservoir (thin, black)
5. Connecting pieces

6. Connect the salt hose to the water softener head in the associated pipe connection and tighten the nut by hand. The drain hose and the salt hose must not be exchanged as they have individual dimensions.
7. Then install pressure hoses for raw water and soft water outlet, respectively, on the system (1 and 2 in the photo above).

8. Lead the drain hose to the floor drain.
9. The salt reservoir is provided with an overflow connector which is lead to the floor drain.



10. The system is now ready for start-up
NB! There must always be a floor drain to avoid damage caused by leakage.

B. Start-up procedure

1. Check that the number on the standard-installed meter disc corresponds to the hardness on site. If not, the meter disc must be replaced. Order the correct meter disc from KINETICO or from your supplier.

Adjustment of salt valve in salt reservoir

2. To obtain the right setting of the adjustment tube, a certain number of tabs must be removed (the yellow plastic part in the photo to the right). This is done using a sharp knife, removing the tabs individually with the knife – cut in the longitudinal direction under the tabs. Keep the number or letter that is to be the setting point as the top tab.
3. Adjust the float in the following manner: the numbers for the float are indicated on the adjusting rod (photo to the right). The top edge of the float must be aligned with the number strip. (NB! with CP 213s, the bottom edge of the float applies). The holder of the salt valve must be positioned horizontally above the valve and the adjusting rod must be parallel with the valve tube, i.e. the adjusting pipe must not be twisted.



4. When installing the salt valve, be careful not to drop it down into the cylinder. If it is dropped, the float may sink and give an incorrect setting. Place the valve in such a way that the bent 3/8" pipe is placed along the back of the salt well away from the cylinder wall. Now press the 3/8" bent pipe into the notch, so that it extends 25 mm from the brine cylinder (see photo to the right).



5. The valves and the outlet sides and the bypass valve (if installed) must be closed.

6. Open the valves on the inlet sides slightly so that the filter slowly fills with water. At the same time, the brine tank will be filled with water by means of the brine valve.



7. First, set one and then the other tank in back-wash mode for a while to vent any air from the system. Do this by pressing down the Phillips screw at the centre of the automatics while turning it clockwise. Check that the water runs out of the outlet hose to the drain.

8. When any air has been vacated from the system, start the filter (black dot, 12 or 6 o'clock position) by turning Phillips screw again.

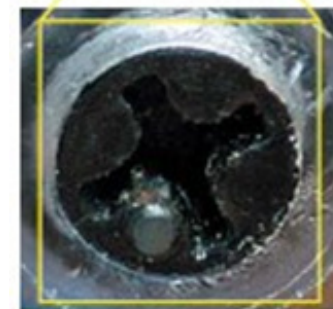

9. Then open the valve on the outlet and inlet side fully.

10. Check that the water runs into the salt container vat until the brine valve on the tank closes. Check that the water is above the mesh plate.

11. Fill the tank with salt tablets.

12. Normally, there must be so much salt in the salt reservoir that the water is completely covered - top up with salt.

13. The system is now ready for operation and will produce softened water right away.

DECLARATION OF CONFORMITY FOR CE CERTIFICATION

In Accordance to ISO/IEC Guide 22

For

WATER SOFTENING UNITS

MANUFACTURER: Kinetico Incorporated
10845 Kinsman Road
Newbury, OH 44065
Phone: 440.564.9111 Fax: 440.564.4407

MODEL NUMBERS: 2020C, 2025S, 2030S, 2050S, 2060S, 2100S, 2175S,
4050S, 2060S OD, 2100S OD, HT613, HT618, HT621,
CC206C, CC208C, 2175S, CP213S OD, CP216S OD

REPORT NUMBERS: AAAQ1594-01S

DIRECTIVE: Low Voltage Directive (72/23/EEC), 1973; including
Amendment (93/68/EEC), 1993

STANDARD: EN 14743 – Water Equipment Inside Buildings: Softeners –
Requirements for Performance, Safety and Testing

TEST FACILITY: F-Squared Laboratories
26501 Ridge Rd.
Damascus, MD 20872

The water softening units, model numbers 2020C, 2025S, 2030S, 2050S, 2060S, 2100S, 2175S, 4050S, 2060S OD, 2100S OD, HT613, HT618, HT621, CC206C, CC208C, 2175S, CP213S OD, CP216S OD are in effective conformance to the Directive and Standard referenced above.

Authorized By:



Thomas P. Goshe
Standards and Regulatory Compliance Manager
Kinetico Incorporated
June 10, 2010

CONSULTING, SALES AND SERVICE:

Condair A/S
Parallelvej 2, DK-8680 Ry
Phone +45 8788 2100
condair.dk@condair.com, www.condair.dk

