

# Sainlogic-SA7

## Quick Setup Guide



### Product Includes:

- Integrated outdoor transmitter
- Gateway
- Rain collector
- Wind Cups
- Wind vane
- Mounting brackets and accessories
- Instruction manual
- Power Adapter

### Recommended Tools:

- Precision screwdriver (for small Phillips screws)
- Compass or GPS (for wind direction calibration)
- Adjustable wrench

### Step 1:

Locate the battery door on the bottom of the transmitter, remove the retaining screws on the back of the sensor, remove the battery door, insert 3 new AA batteries and close the battery door.



### Step 2:

After installing the batteries, the Integrated Outdoor Sensor LED will illuminate for 3 seconds and then blink every 60 seconds. If it does not flash, press the **reset** button.

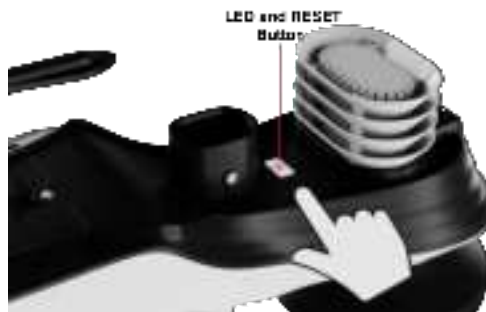

### Step 3 (Pairing mode) :

1. Plug in the device with the power adapter.
2. Please press and hold the **"Pair"** button for 3 seconds to enter the Pairing mode, the indicator light (red) flashes fast, the indicator light (red, green) will flash alternately after successful pairing.



**Note:**You need to check if the device is online in the **"Weatherseed"** app.

Referring to the instructions on the following page.

Learn how to make the gateway connect to WiFi and how to download the **"Weatherseed"** APP and register to log in.



- 3.If the gateway is in pairing status, one click to exit pairing mode.

**Step 4:**

Please search "Weatherseed" APP in Google Play Store or IOS App Store.

**Step 5:**

Register and login to your own Weatherseed account:

- (1) Fill in the e-mail address;
- (2) Send a verification code to the e-mail address and enter the code;
- (3) Set a password;
- (4) Confirm the password (must be consistent with the set password);
- (5) Check the user agreement and proof of age;
- (6) Register account.

 **Note:**



**The weather station only supports 2.4 GHz signals. If you have a dual-band router (2.4 GHz and 5.0 GHz), make sure the router's 2.4 GHz band is turned on. And separate it from the SSID of the 5.0 GHz channel for accurate connection to 2.4 GHz.**

**Step 6: WiFi Connection Steps (3 steps)**

 **Note :** *The power adapter needs to be plugged into connect to WiFi.*

 **Note :** *Please don't choose the wrong type and model , if you choose the wrong one, you can't match the network successfully.*

 **Note:** *The QR code is at the top of the Gateway.*

 **Note:** *Requirements for routers*

1. *The weather station can only connect to 2.4 GHz, but could not do it automatically. It could not distinguish between the signals and kept trying to connect to 5 GHz.*
2. *The router had to have the signals "split".*

*If you own a dual band router including both 2.4G and 5G, you need to separate the two SSID names for the 2.4G/5G dual band. Then you can re-power up the router and try it again.*

 **Note :** *If the device is frequently offline, it must be reset. The router should always be on,*

it will show offline after no WiFi.

### 1. Bluetooth Distribution Network Mode(Recommend)

Please press and hold the “Internet” button for 3 seconds, the device will enter the network mode. By default, the first network mode is “Bluetooth distribution network” mode, the indicator light (green) blinks about 0.5s kind of blinking once.

(1) Select product model. Set the name and location by yourself;

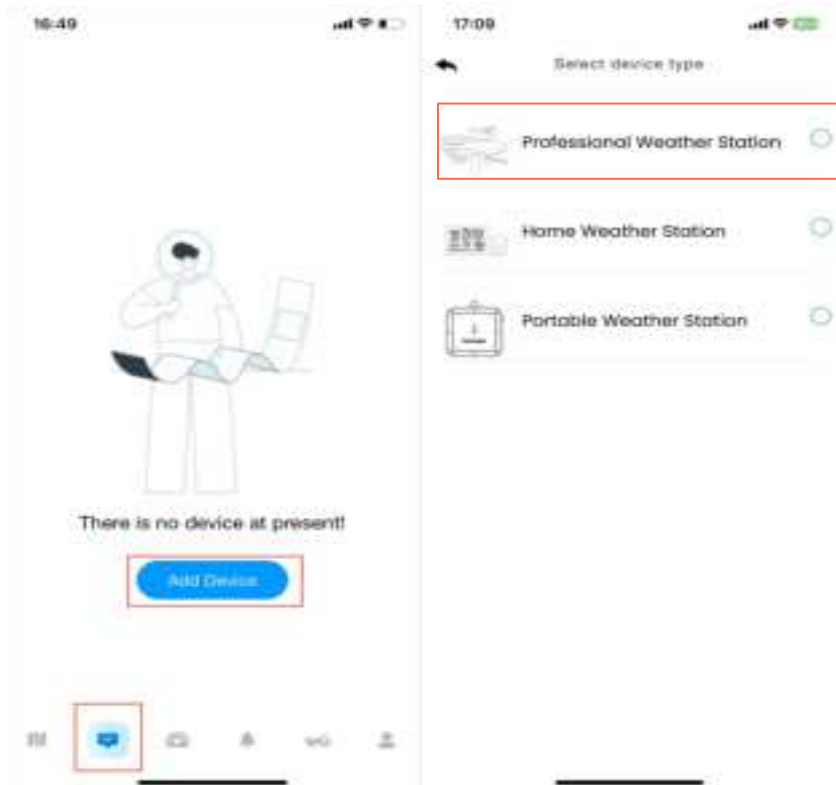

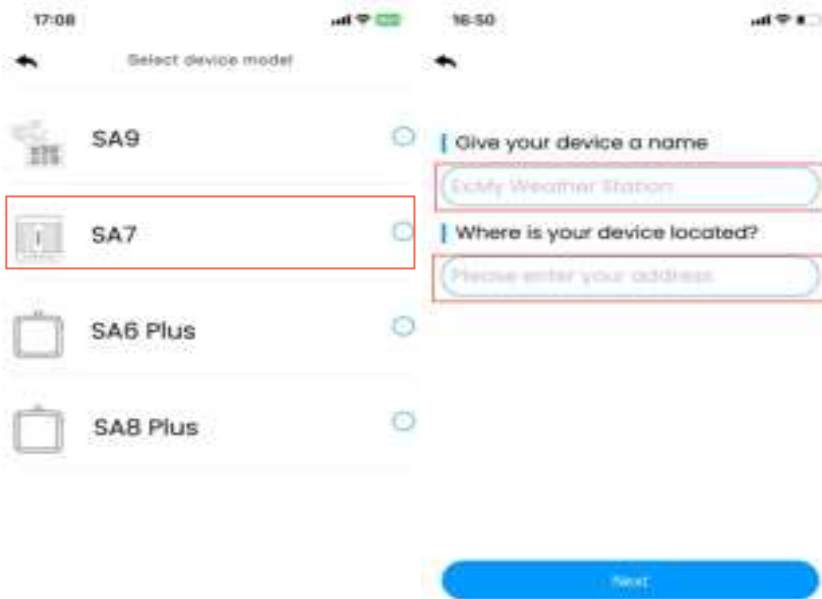

(2) Follow steps 1 through 3 for WiFi connectivity, scan the QR code and then select the distribution method.

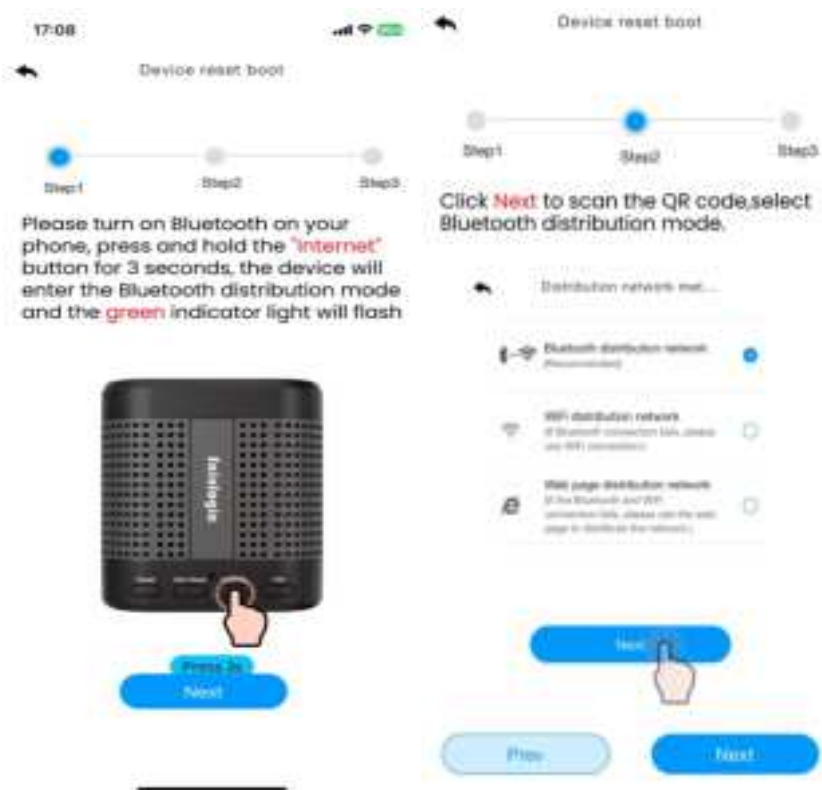



(3) Select the "Bluetooth distribution network" to automatically search for Bluetooth signals and pairing. After successful pairing, jump to WiFi interface. Please select 2.4Ghz WiFi and enter the password.



## 2. WiFi Distribution Network Mode

Please press and hold the “Internet” button, the device will enter the “Bluetooth distribution network” mode. Then please long press the the “Internet” button again for at least 3 seconds, the

device will enter “WiFi distribution network” mode, the indicator light (green) will blink once in 1s. After the gateway enters the “WiFi distribution network” mode, please open the APP to start networking:

(1)Select product model. Set the name and location by yourself;

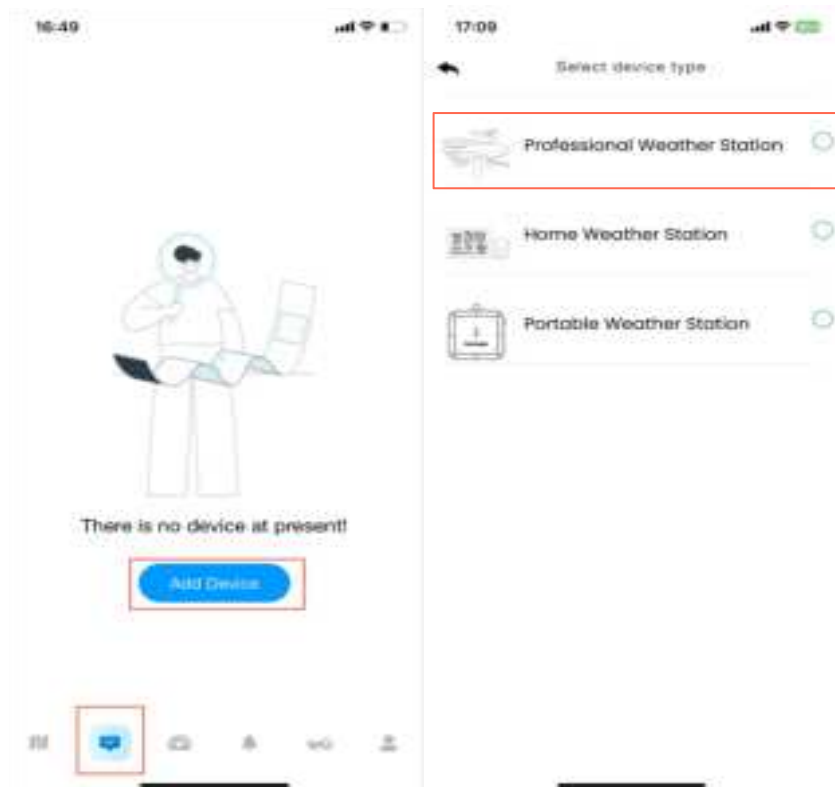

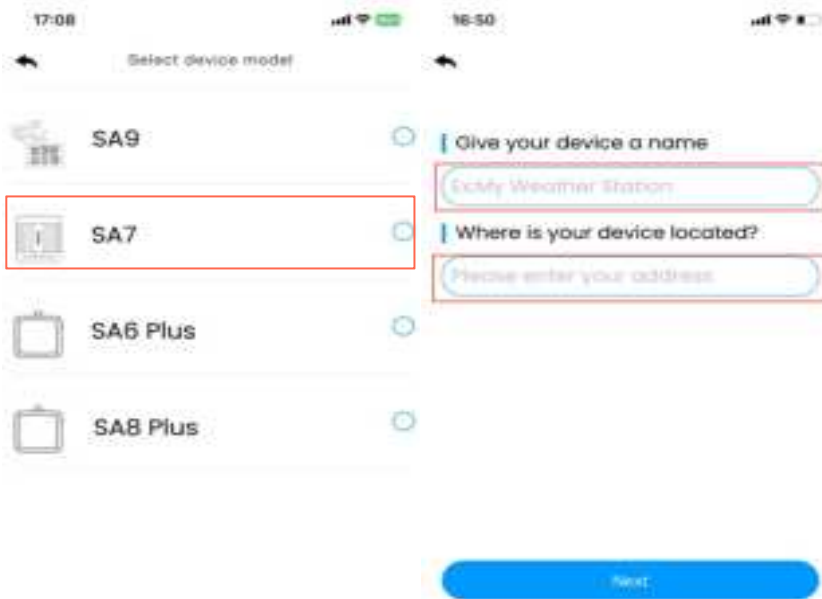

(2) Follow steps 1 through 3 for WiFi connectivity, scan the QR code and then select the distribution method.

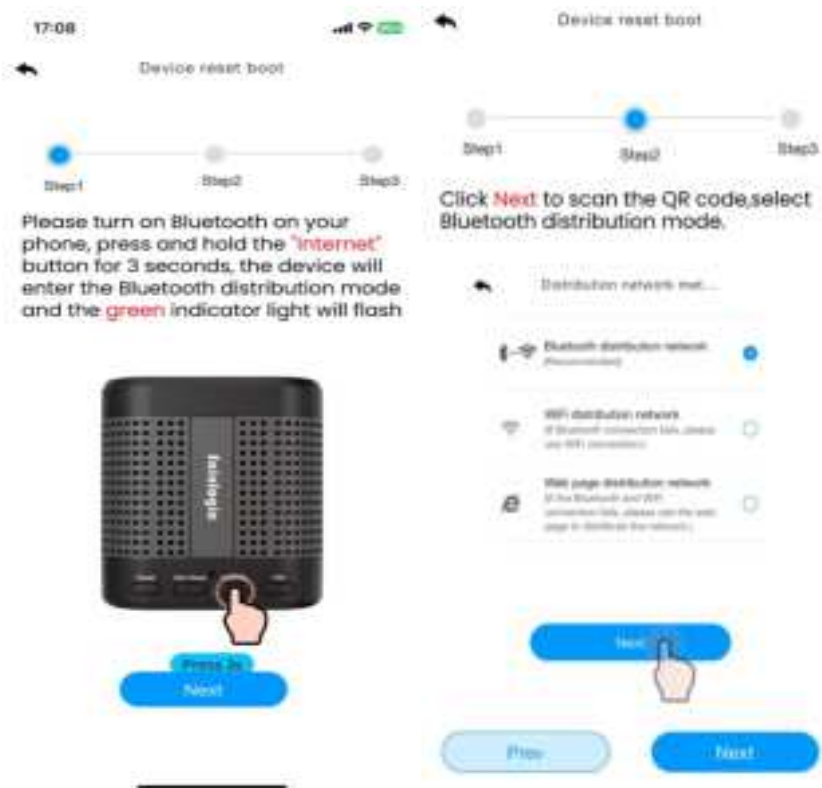



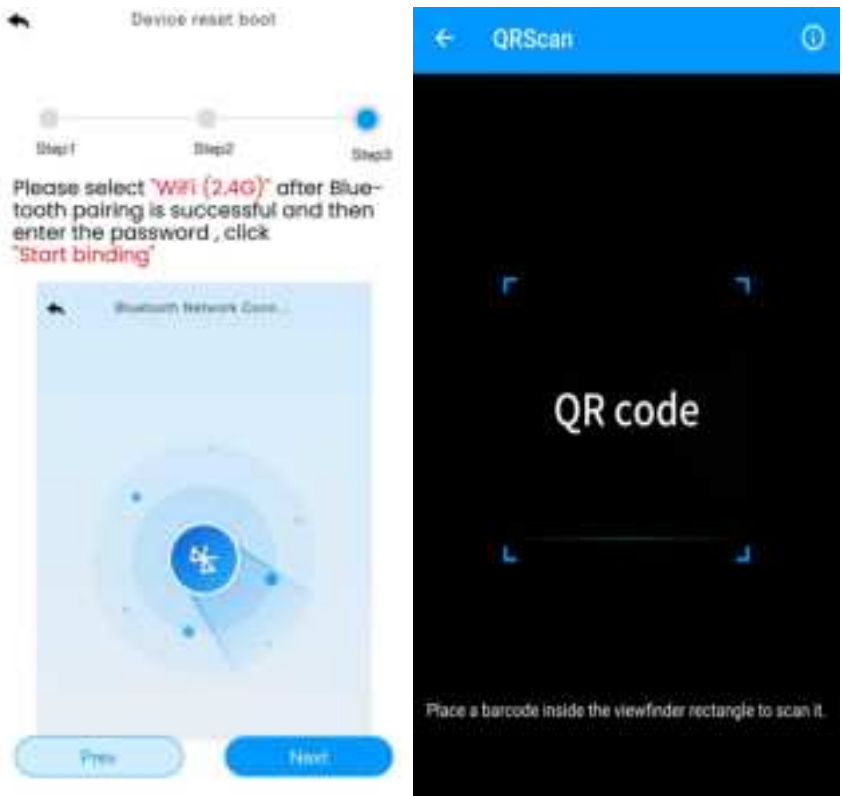

(3) Choose the “WiFi distribution network” mode, select the router WiFi name (2.4Ghz), then enter the password and click “Next”.

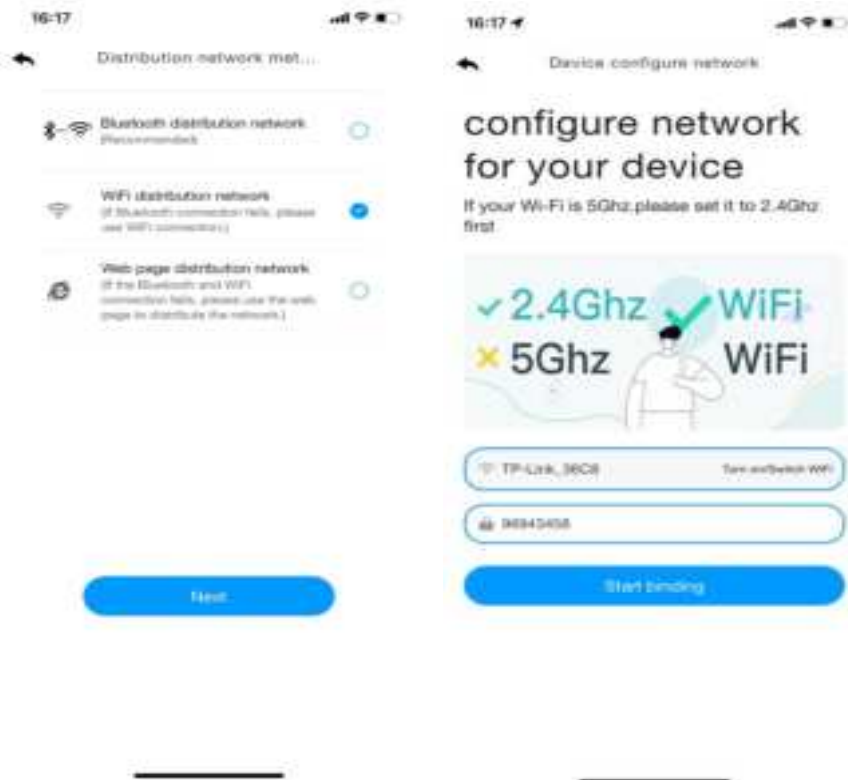



### 3. Web page distribution network mode

Please press and hold the **“Internet”** button to enter the distribution network mode, the device will enter **“Bluetooth distribution network”** mode. Then please long press the **“Internet”** button again for at least 3s, the device will enter **“WiFi distribution network”** mode. In **“WiFi distribution network”** mode, press and hold again for 3s to enter the **“Web page distribution network”** mode, the indicator light (green) will blink once in 2s.

After the gateway enters the **“Web page distribution network”** mode, please open the APP to start networking:

- (1) Select product model. Set the name and location by yourself;

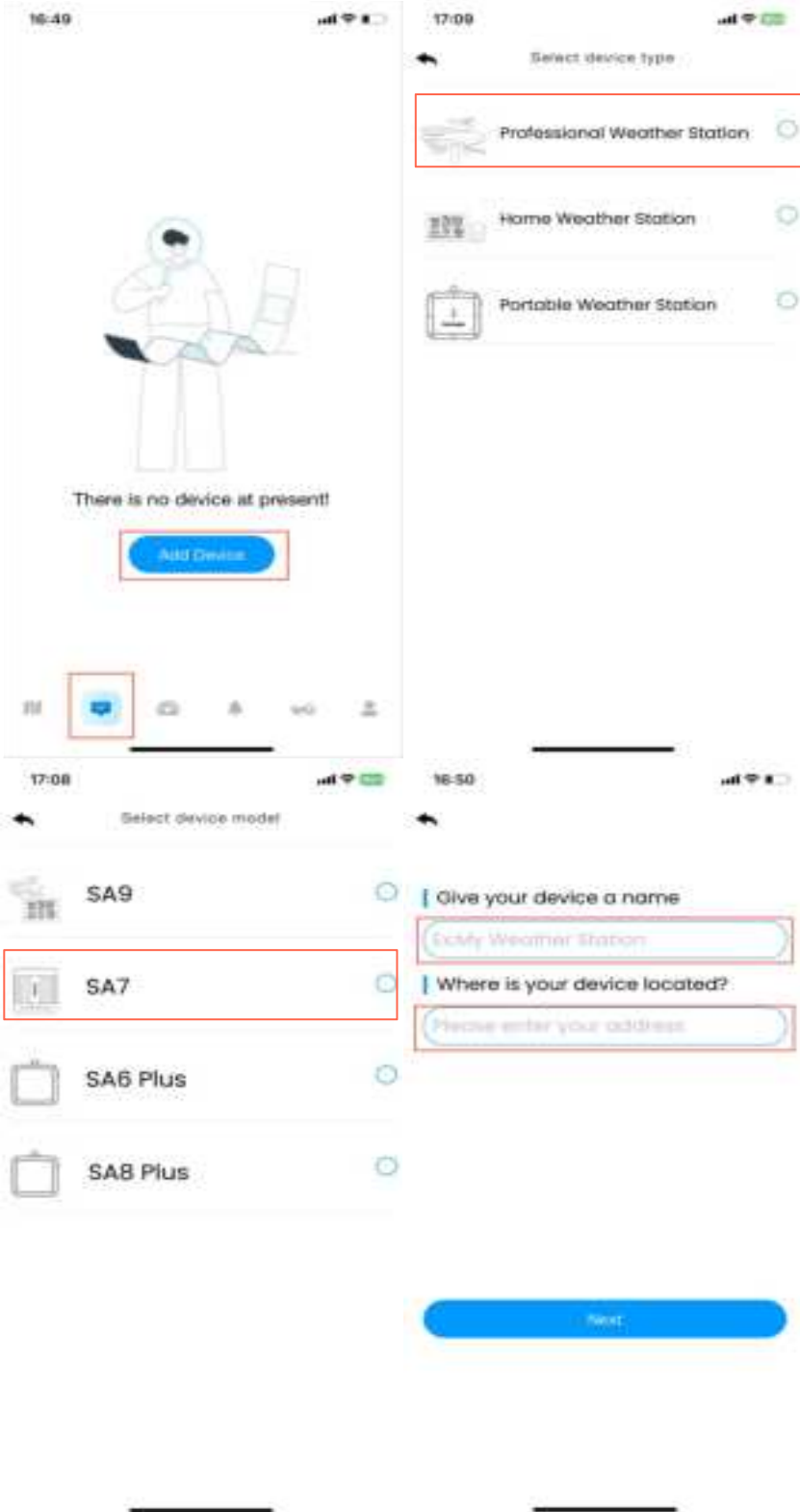

(2) Follow steps 1 through 3 for WiFi connectivity, scan the QR code and then select the distribution method.

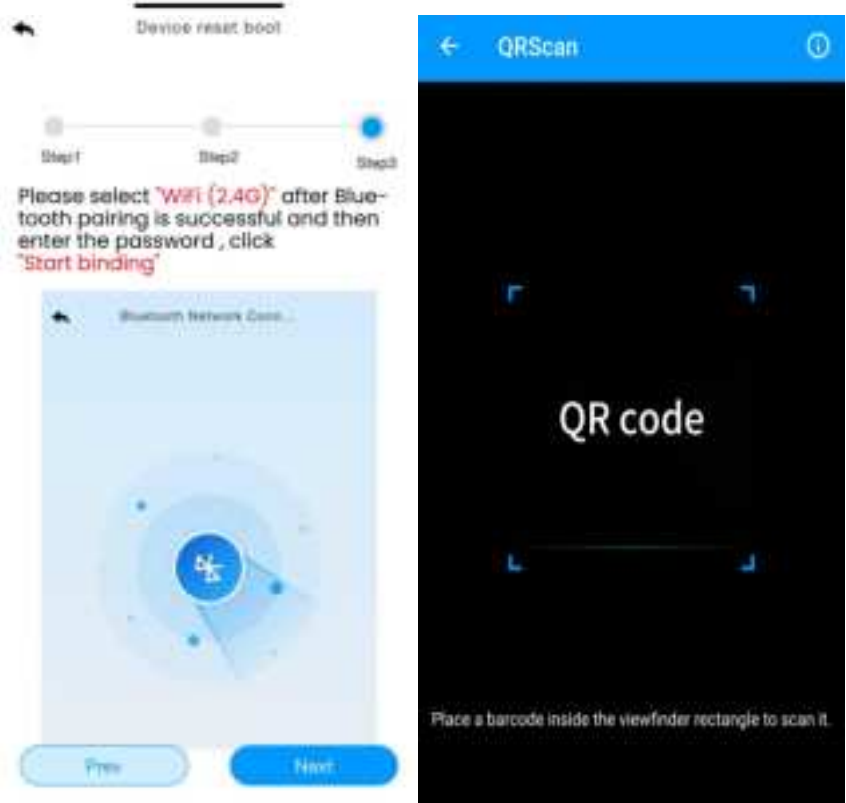
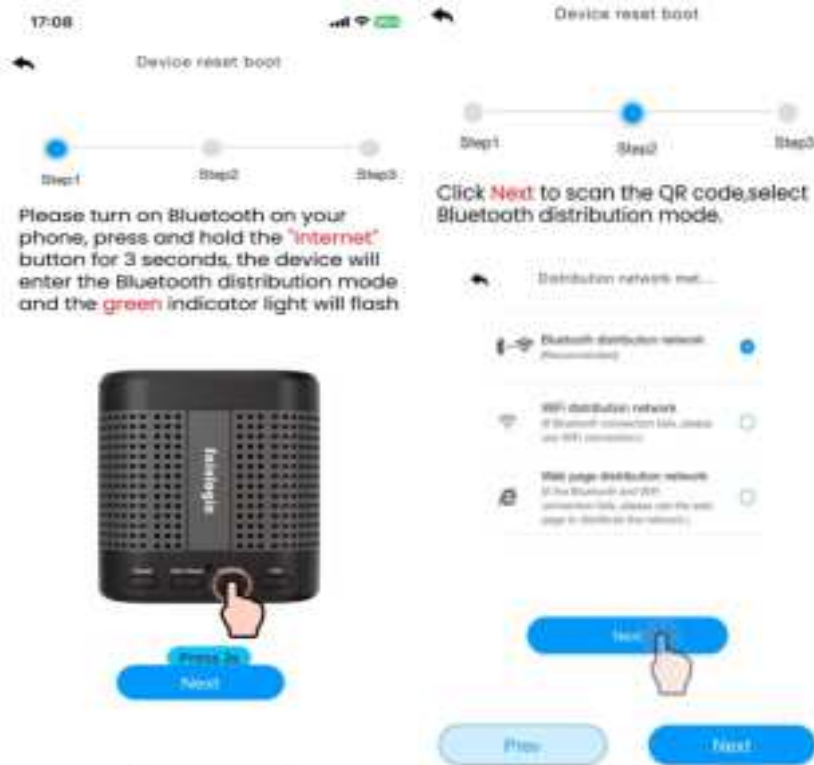

(3) Choose the " Web page distribution network" mode. Click Go to connect to WiFi. Automatically jump to the WiFi list screen, click Connect " weatherseed " WiFi.

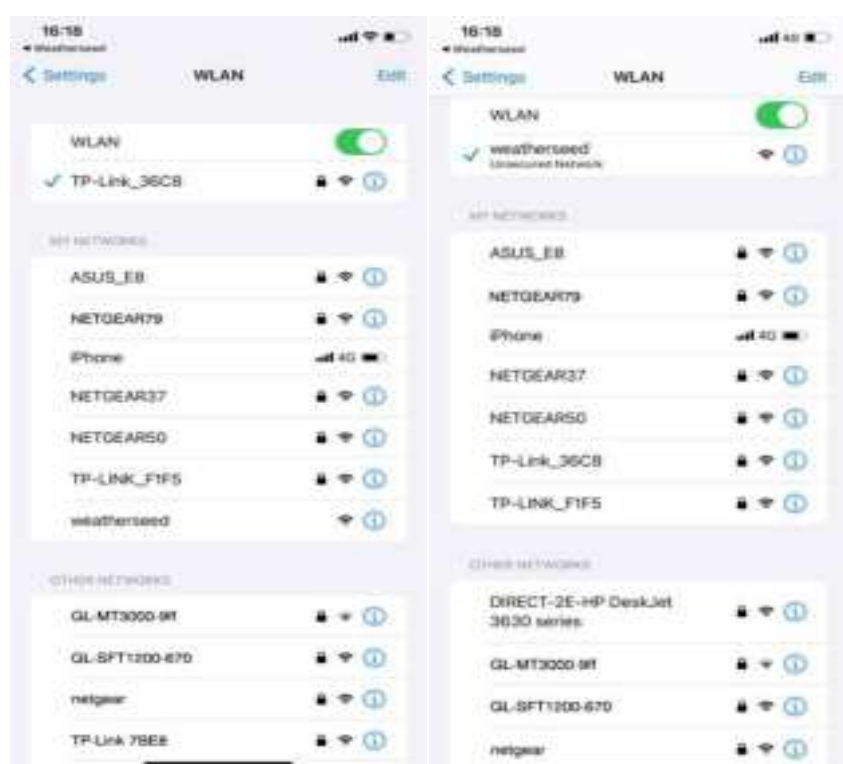
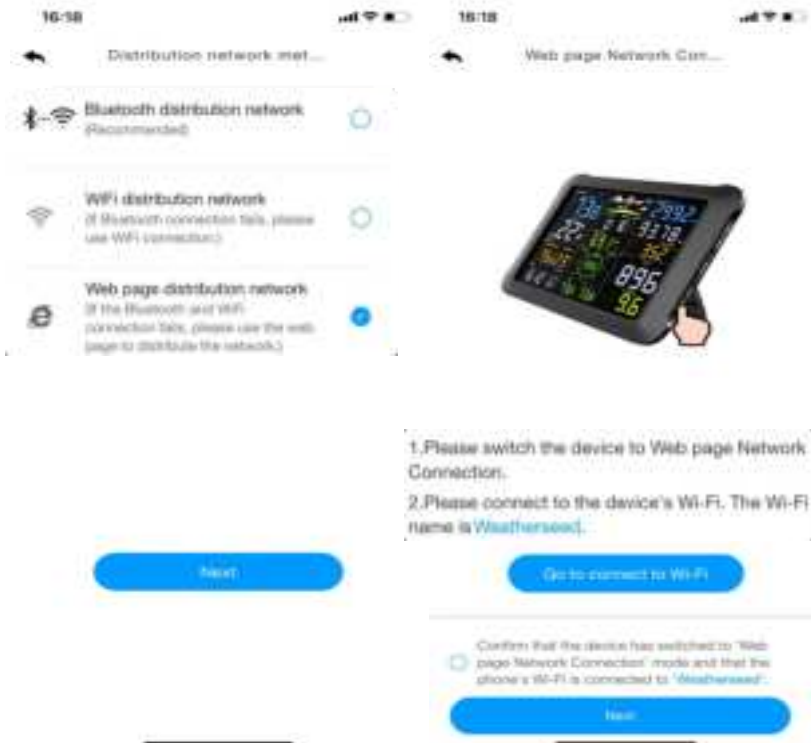

(4) Return to the app, click the confirmation dot and click "Next". Please select 2.4Ghz WiFi, enter the password and click "Connect".

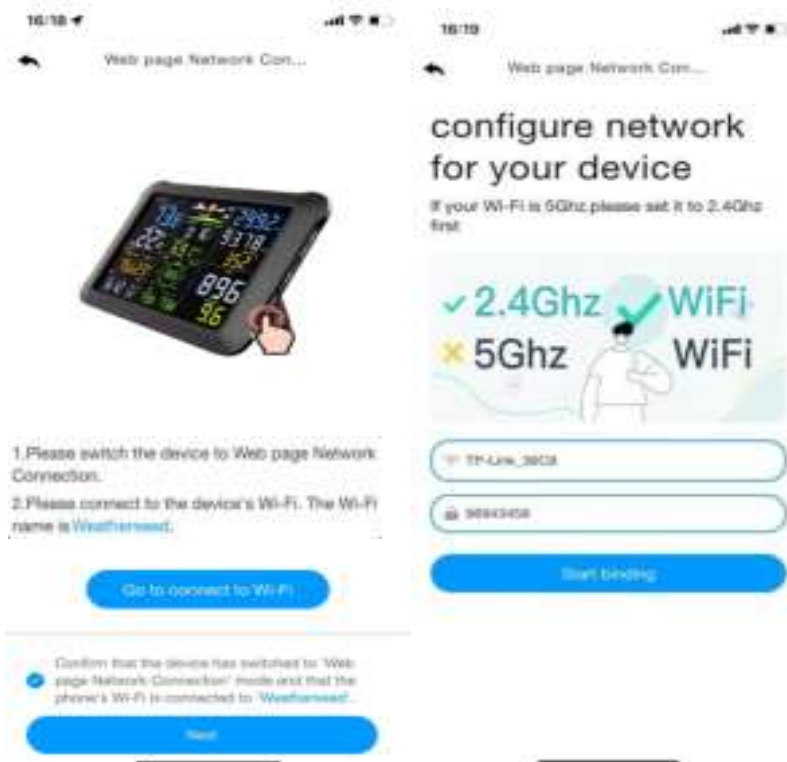

 **Note: Android system can select WiFi. IOS system needs to manually enter the WiFi name.**

If you have any questions, please feel free to contact us. You can reach us via Customer Support Email, Customer Support phone, or social media accounts.

Customer Support Email: [info@sainlogic.com](mailto:info@sainlogic.com)

Website: [www.sainlogic.com](http://www.sainlogic.com)

Customer Support Phone: +1 (888) 513-9823 (Mon-Fri 10 a.m. - 6 p.m, Eastern Standard Time)

If you need to register or apply for a warranty, please contact us by Customer Support.

Customer Support Email: [sainlogicwarranty01@gmail.com](mailto:sainlogicwarranty01@gmail.com)

Website: <https://www.sainlogicwarranty.com/>

YouTube:

<https://www.youtube.com/@sainlogicbrand>

Facebook:

<https://www.facebook.com/sainlogicofficial>

Instagram:

[https://www.instagram.com/sainlogic\\_official/](https://www.instagram.com/sainlogic_official/)

Twitter:

<https://twitter.com/sainlogicbrand>

TikTok:

<https://www.tiktok.com/@sainlogic>

**ACTIVATE WARRANTY AND CLAIM THE  
1-YEAR FREE EXTENSION**

Activate within 14 days by visiting:

**[WWW.SAINLOGICWARRANTY.COM](http://WWW.SAINLOGICWARRANTY.COM)**

Have questions?

Reach us at:

[sainlogicwarranty01@gmail.com](mailto:sainlogicwarranty01@gmail.com)

# Sainlogic SA7 Weather Station User Manual

## Content

1.Introduction .....	3
2.Warning and Cautions .....	3
3.Quick Start Guide .....	3
4.Assembly of sensor arrays .....	4
4.1.Parts List .....	4
4.2.Recommended tools .....	6
4.3. Remove/Install the Wind Vane .....	6
4.4.Remove/Install the Wind Cup .....	7
4.5.Remove/ Install the rain collector .....	7
4.6. Installation of coil filters .....	8
4.7.Install Battery .....	9
5. Installation of the Sensor Array .....	11
5.1. Pre-installation Check .....	11
5.2. Site Survey .....	11
5.3.Adjusting the Sensor Mounting Direction .....	11
5.3.1.Northern Hemisphere Reference .....	12
5.3.2.Southern Hemisphere Reference .....	12
5.4.Securing the Mounting Pole .....	13
5.4.1.Horizontal mounting and fixing sensors .....	14
5.4.2.Vertical mounting and fixing sensors .....	14
5.4.3.Best Practices for Wireless Communication .....	15
6.Install the gateway .....	16
6.1.Button Operation .....	16
7. Gateway connected to WiFi .....	18
7.1. Real-time Network Monitoring .....	18
7.2.APP Download .....	18
7.3.APP Account Register and Login .....	18
7.3.1. Registering Process .....	18
7.3.2. Login process .....	19
7.4. Connecting Steps .....	20
7.4.1 Bluetooth Distribution Network Mode .....	20
7.4.2. Wifi Distribution Network Mode .....	24
7.4.3. Web page distribution network mode .....	28
7.5.Firmware Upgrade .....	33
7.6. Sign up on Wunderground.com .....	34
8. Time Zone .....	36
9.Data Discussion .....	37
10. Feels Like Temperatures .....	40
11.Glossary of Terms .....	41



12.Specifications ..... 42  
    12.1. Wireless specifications .....42  
    12.2. Measurement Specifications ..... 42  
    12.3. Power Consumption ..... 43  
13. Maintenance ..... 44  
14. Troubleshooting Guide .....45  
15.Disclaimer ..... 47  
16. Warranty Information ..... 47  
17. FCC Statement .....48

## 1.Introduction

Thank you for purchasing the Sainlogic Professional WiFi Wireless Weather Station. The following user guide provides detailed instructions on installation, operation and troubleshooting. This product is constantly changing and improving, especially the online services and associated applications.

To download the latest manuals and other help, please contact Customer Support.

Customer Support Email: [info@sainlogic.com](mailto:info@sainlogic.com)

Website: [www.sainlogic.com](http://www.sainlogic.com)

Customer Support Phone: +1 (888) 513-9823 (Mon-Fri 10 a.m. - 6 p.m, Eastern Standard Time)

## 2.Warning and Cautions

 **WARNING:** Lightning strikes can be caused by any metal object, including your weather station mounting pole. Mounting your weather station during a storm is prohibited.

 **WARNING:** Installing a weather station in an elevated location may result in injury or death, so perform as many preliminary checks and operations as possible on the ground and inside a building or house.

 **WARNING:** Install the weather station on a clear, dry day.

## 3.Quick Start Guide

The following Quick Start Guide provides the necessary steps to install and operate the weather station.

1	Assembling and activating the outdoor sensor array	4-5
2	Gateway button definition	6
3	Connecting the device to Wi-Fi	7
4	Data Definition and Discussion	8-11
5	Specification	12
6	Troubleshooting	14

## 4.Assembly of sensor arrays

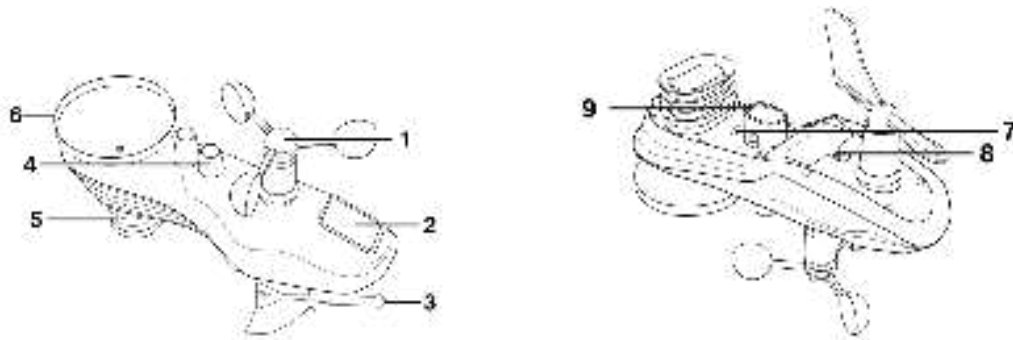











Figure 1

NO	Description	NO	Description
1	Wind Cup	7	Reset Button/LED Indicator
2	Solar Panel	8	Battery Door
3	Wind Vane	9	Mounting Pole Socket
4	Bubble Level		
5	Thermometer-Hygrometer Sensor		
6	Rain Collector		

### 4.1.Parts List



The weather station consists of the following parts.

QTY	Item	image
1	<b>Gateway:</b> <b>Frame Dimensions:</b> 3.1x3.1x3.6inch (78x78x91mm)	

1	<p><b>Integrated Outdoor Transmitter Dimensions:</b> 12.9x4x9.8inch (327x101x249mm)</p>	
1	<p><b>Foot Mounting (with pole insert)</b> Dimensions: 4.25x4.1x1.75inch (107x104x44.5mm)</p>	
1	<p><b>Mounting Bracket Back Plate (pole mount)</b> Dimensions: 4x3.25x1inch (101x82x25mm)</p>	
1	<p>Mounting Pole Dimensions: 12.8x1.3x0.9inch (325x33x22mm)</p>	
2	<p>Pole mounting nuts (M3) / bolts Ø3)</p>	
4	<p>Pole mounting nuts (M5) / bolts ( Ø5)</p>	
4	<p>Tapping screws</p>	
1	<p>Manual</p>	
1	<p>Power Adapter</p>	

## 4.2.Recommended tools

We recommend using the following tools to assist in the installation of the weather station.

1	Precision screwdriver (for small Phillips screws)	
2	Compass or GPS (for wind direction calibration)	
3	Adjustable wrench	

## 4.3. Remove/Install the Wind Vane

**Remove the wind vane:** (refer to Figure 2)

(a) Locate the black waterproof silicone plug in the center of the round cap at the top of the wind vane and pick it out with a tool.

(b) Use a precision screwdriver to loosen the set screw in the round hole until the wind vane can be easily removed.

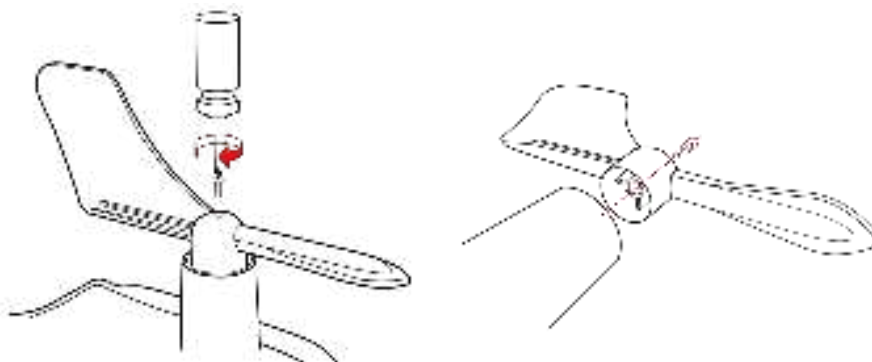

**Figure 2**

**Install the Wind Vane:**

(c) Put the round hole at the bottom of the wind vane against the wind vane shaft and tighten the fixing screws with a precision screwdriver to make sure the wind vane can rotate freely.

(d) Insert the black waterproof silicone plug into the round hole at the top of the wind vane and make sure it fits into the round hole to achieve waterproof effect.

 **Note:** The wind vane axis cannot rotate freely like the wind cup, which is specially designed by us.

#### 4.4.Remove/Install the Wind Cup

**Remove the wind cup:** (refer to Figure 3)

(a) Locate the black waterproof silicone plug in the center of the round cap at the top of the wind cup and pick it out with a tool.

(b) Use a precision screwdriver to loosen the set screw in the round hole until the wind cup can be easily removed.

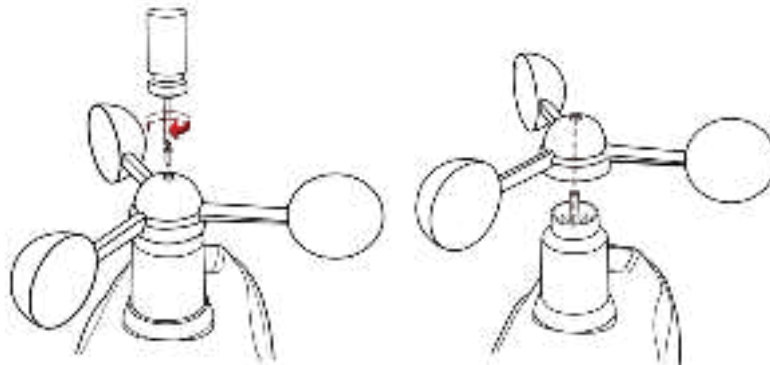

**Figure 3**

**Install the wind cup:**

(a)Place the round hole at the bottom of the wind cup against the wind vane axis and tighten the fixing screw with a precision screwdriver to ensure that the wind cup can rotate freely.

(b) Insert the black waterproof silicone plug into the round hole at the top of the wind cup and make sure it fits the hole to achieve waterproof effect.

#### 4.5.Remove/ Install the rain collector

**Remove the rain collector:** (refer to Figure 4)

(a) With your hand flat on top of the rain collector, grasp the entire rain collector and rotate it clockwise.

(b) Remove the rain collector vertically upwards when a click is heard.

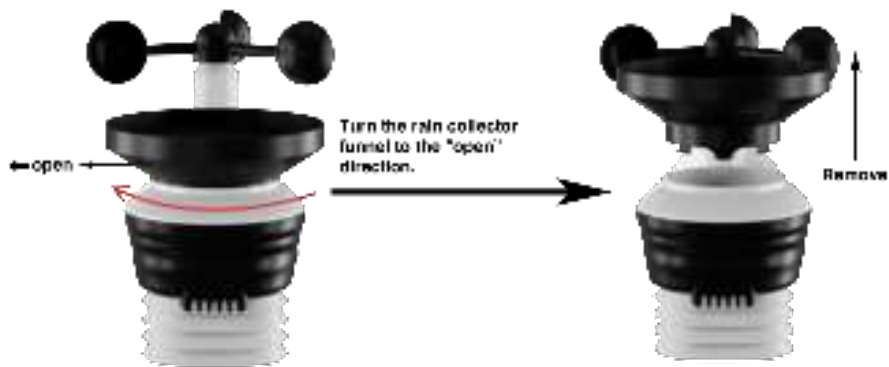

Figure 4

**Remove the rain collector:** (refer to Figure 5)

- (a) Align the snap on the bottom edge of the rain collector with the snap notch on the transmitter so that the two fit perfectly, then press the rain collector down vertically.
- (b) After placing the rain collector into the groove, rotate it counterclockwise and it will be installed successfully when you hear a click.



Figure 5

#### 4.6. Installation of coil filters

- (a) Place the coil vertically into the rain collector (hook facing downward) so that the coil fits snugly against the bottom of the rain collector.
- (b) Gently press the coil so that it hooks into the hole at the bottom of the rain collector and locks into place. The tension of the spring will keep the filter tightly fitted to the rain collector.

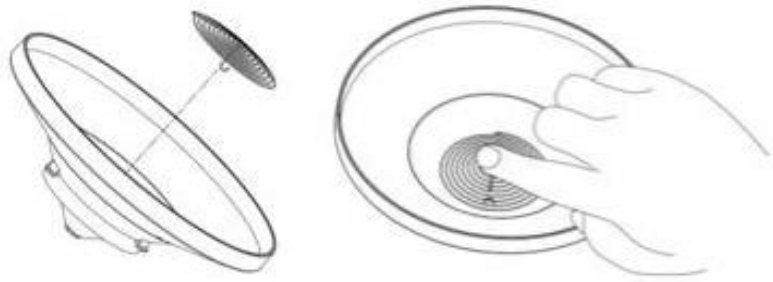

Figure 6

#### 4.7. Install Battery

Find the battery door at the bottom of the transmitter, as shown in Figure 7.

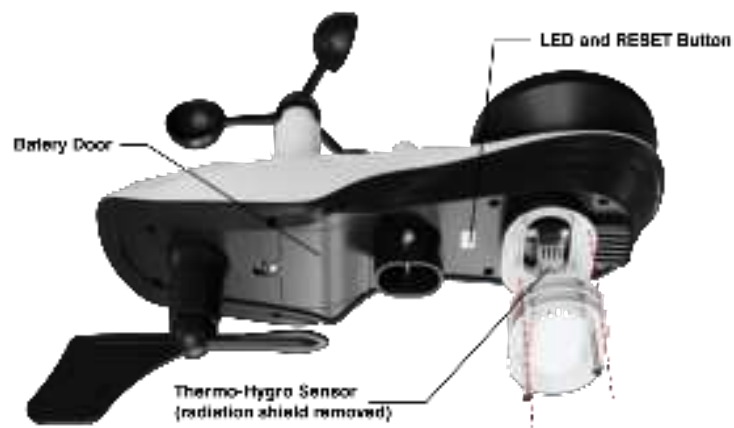



Figure 7

 **Note: Do not install the batteries backwards.** You can permanently damage the outdoor sensors. The solar panel does not charge the batteries, so rechargeable batteries are not recommended.

Remove the battery door on the back of the sensor by removing the set screw, as show in Figure 8.



Figure 8



Insert 3 new AA batteries and close the battery door as shown. Before closing the battery door and tightening the set screws, make sure the washers (around the inside perimeter of the battery door) are properly secured in their tracks.



Figure 9

 **Note:** We recommend installing AA lithium batteries for the Outdoor Sensor in cold weather environments.

When the battery is installed, the Integrated Outdoor Sensor LED indicator will illuminate for 3 seconds and then blink every 60 seconds. The sensor is transmitting data each time it blinks.

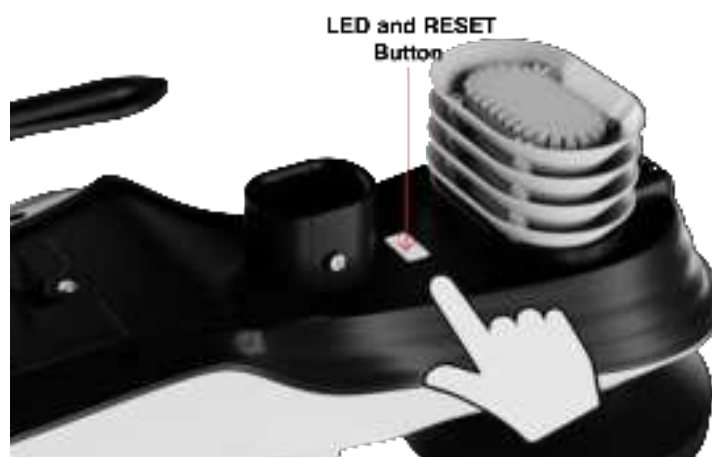



Figure 10

 **NOTE:** If the sensor LED does not flash after inserting the batteries, press the reset button on the bottom of the sensor as shown in Figure 10.

## 5. Installation of the Sensor Array

### 5.1. Pre-installation Check

Before installing the weather station at a permanent location, we recommend running it at a temporary, easily accessible location for one week. This allows you to check all functions in advance, ensure they are operating correctly, and familiarize yourself with the weather station and calibration procedures.

### 5.2. Site Survey

Before installing the weather station, consider the following points during the site survey:

1. The rain gauge must be cleaned every 3 months and the battery should be replaced every 3 months.
2. Avoid heat radiation transfer from buildings and structures. Generally, the sensor array should be installed at least 5 feet (1.5 meters) away from any buildings, structures, ground, or roofs.
3. Avoid influencing wind speed and rainfall measurements. The installation distance of the sensor array should be at least four times the height of the highest obstacle. For example, if a building is 20 feet (6 meters) high and the installation pole is 6 feet (2 meters) high, the installation distance should be  $4 \times (20 - 6) = 56$  feet (17 meters). If the weather station is installed close to tall buildings, wind speed and rainfall measurements will be inaccurate.
4. Radio signal range. Assuming no interference from buildings, trees, vehicles, high-voltage lines, etc., the radio communication distance between the gateway console and the transmitter can reach up to 330 feet (100 meters). In most cases, due to interference from buildings and walls, most wireless applications can only reach up to 100 feet (30 meters). Radio signals cannot penetrate metal buildings.
5. In the worst-case scenario, radio interference from personal computers, radios, or televisions can completely cut off radio communication. Therefore, consider this when selecting the gateway console or installation location.

### 5.3. Adjusting the Sensor Mounting Direction

This professional weather station can be used in both the Northern and Southern Hemispheres. To ensure the accuracy of the wind direction display, please secure the direction of the integrated outdoor sensor before installation.

 **Note: Wind direction is indicated by the letters N, E, S, and W. (N is north, E is east, S is south, W is west)**

### Northern Hemisphere



### Southern Hemisphere

Figure 11

#### 5.3.1. Northern Hemisphere Reference

The body of the outdoor sensor is embossed with the four cardinal directions: N, E, S, W, which are applicable only in the Northern Hemisphere.

**Step 1:** As shown in the diagram, there is an "S" indicator on the wind vane representing south.

Using a compass, check the direction and adjust the orientation of the entire sensor to ensure the "S" mark on the sensor aligns with the south.

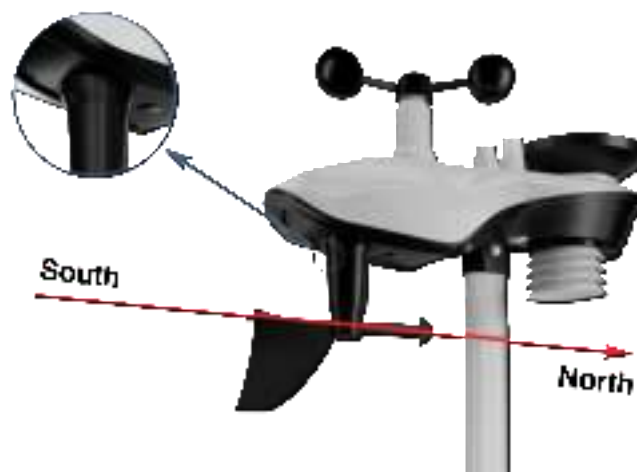

Figure 12

#### 5.3.2. Southern Hemisphere Reference

For installing the integrated outdoor sensor in the Southern Hemisphere, disregard the four

directions (N, E, S, W) marked on the sensor body. When installing, adjust the orientation of the entire outdoor sensor to ensure the solar panel faces north (and is positioned to receive maximum sunlight), as shown in the diagram.

**Step 1:** Install the Integrated Outdoor Sensor  
Ensure the solar panel is facing north.



Figure 13

 **Note:**

If the integrated outdoor sensor is not positioned correctly during installation, it will result in permanent wind direction errors.

### 5.4. Securing the Mounting Pole

Observe the bubble level next to the rain gauge to ensure the bubble is stable within the circle, keeping the sensor array completely level. If the sensor array is not level, the rain gauge will not measure accurately.

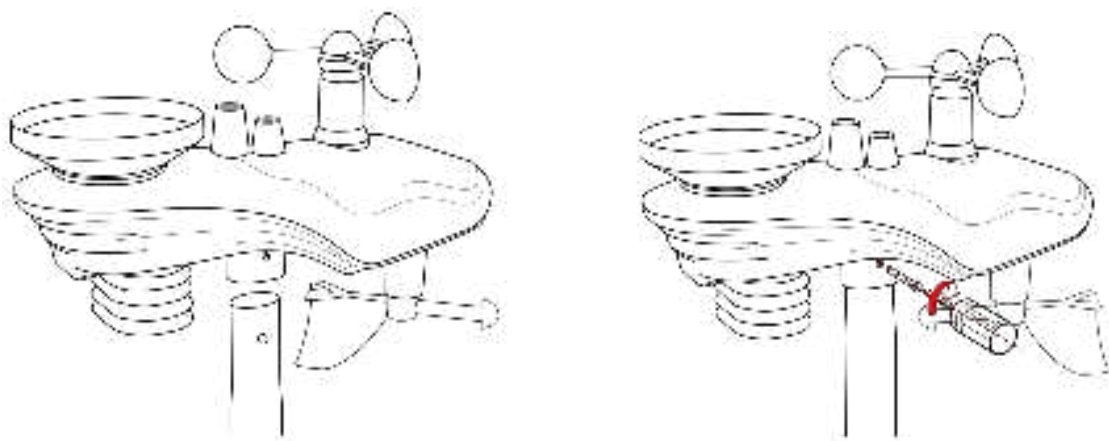
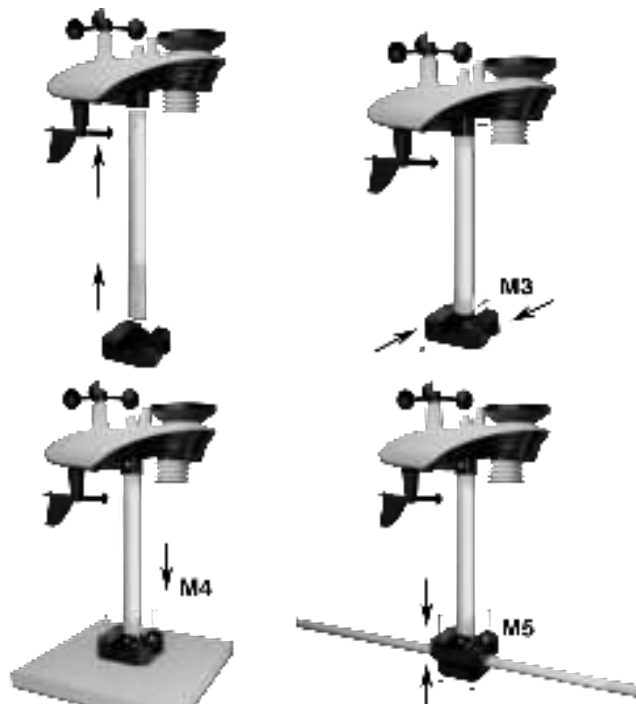

**Figure 14**

 **NOTE:** If the bubble level cannot be read due to mounting limitations, a horizontal line or level can be placed across the top of the rain gauge for easier viewing.

#### 5.4.1. Horizontal mounting and fixing sensors

Fasten the integrated outdoor sensor to the mounting bar bracket with two mounting bolts ( $\varnothing 4$ )/nuts (M3). Then, tighten the mounting bar to your existing mounting bar with four bolts ( $\varnothing 5$ ) and nuts (M5) or secure it to a flat surface with four self-tapping screws as shown. (Figure 15 )



**Figure 15**

#### 5.4.2. Vertical mounting and fixing sensors

Fasten the integrated outdoor sensor to the mounting bar bracket with two mounting bolts ( $\varnothing 4$ )/nuts (M3). Then, tighten the mounting bar to your existing mounting bar with four bolts ( $\varnothing 5$ ) and nuts (M5) or secure it to a flat surface with four self-tapping screws as shown.(Figure 16)

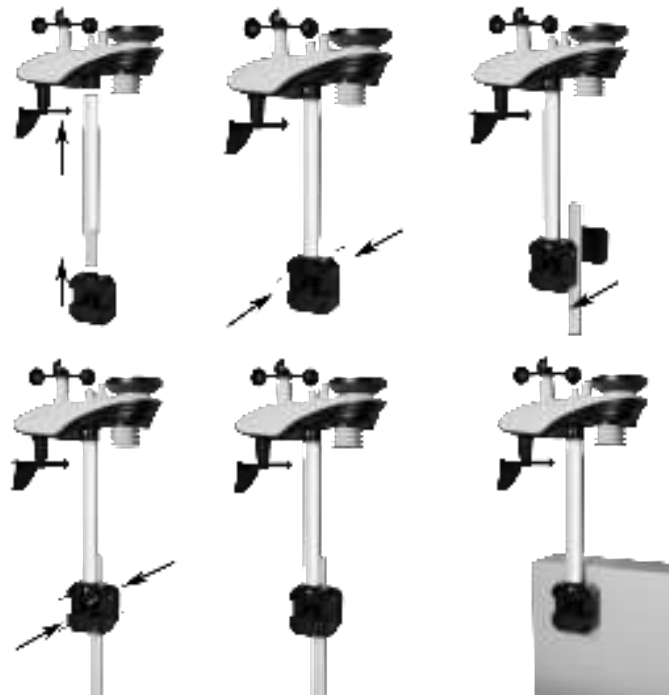

Figure 16

#### 5.4.3. Best Practices for Wireless Communication

Wireless communication is susceptible to interference, distance, walls, and metal barriers. We recommend the following best practices for trouble-free wireless communication.

1. **Electro-Magnetic Interference (EMI):** Keep the console several feet away from computer monitors and TVs.
2. **Radio Frequency Interference (RFI):** If you have other 433 MHz devices and communication is intermittent, try turning off these other devices for troubleshooting purposes. You may need to relocate the transmitters or receivers to avoid intermittent communication.
3. **Line of Sight Rating:** This device is rated at 300 feet line of sight (no interference, barriers, or walls), but typically you will get 100 feet maximum. [This is under most real-world installations, which include passing through barriers or walls].
4. **Metal Barriers:** Radio frequency will not pass through metal barriers, such as aluminum siding. If you have metal siding, align the remote and console through a window to get a clear line of sight. The following is a table of reception loss, versus the transmission medium. Each “wall” or obstruction decreases the transmission range by the factor shown below:

Medium	Radio Frequency (RF) signal strength reduction
Glass (untreated)	5-15%
Plastic	10-15%
Wood	10-40%
Brick	10-40%

Concrete	40-80%
Metal	90-100%

## 6.Install the gateway



**Figure 17**

1. Please plug in the gateway console with the power adapter.
2. Please press and hold the fourth button for 3 seconds to enter the pairing mode, the indicator light (red) flashes fast, the indicator light (red, green) will flash alternately after successful pairing.
- 3.If the gateway is in pairing status, one click to exit pairing mode

### 6.1.Button Operation



**Figure 18**

The gateway has the following 4 buttons for setting the gateway function by short press, long press or double tap.



Key	Description
<p><b>1-Reset Button</b></p>	<p><b>Reset:</b> Please press and hold the “<b>Reset</b>” button for 3 seconds, the gateway will disconnect the pairing with the transmitter.</p>
<p><b>2-Rain Reset Button</b></p>	<p><b>Rain Reset:</b> Please press and hold the “<b>Rain Reset</b>” button for 3 seconds, all rain values will be cleared to zero (current hour, 24 hours, week, month).</p>
<p><b>3-Internet Button</b></p>	<p><b>WiFi connection(3 modes):</b></p> <p><b>Bluetooth Distribution Network Mode:</b> Please press and hold the “<b>Internet</b>” button for 3 seconds, the device will enter the network mode. By default, the first network mode is “Bluetooth distribution network” mode, the indicator light (green) blinks about 0.5s kind of blinking once.</p> <p><b>WiFi Distribution Network Mode</b> Please press and hold the “<b>Internet</b>” button, the device will enter “Bluetooth distribution network” mode. Then please long press the button again for at least 3 seconds, the device will enter “WiFi distribution network” mode, the indicator light (green) will blink once in 1s.</p> <p><b>Web page distribution Network Mode</b> Please press and hold the “<b>Internet</b>” button to enter the distribution network mode, the device will enter “Bluetooth distribution network” mode. Then please long press the button again for at least 3s, the device will enter “WiFi distribution network” mode. In “WiFi distribution network” mode, press and hold again for 3s to enter “Web page network distribution” mode, the indicator light (green) will blink once in 2s.</p>
<p><b>4-Paring Button</b></p>	<p><b>Paring:</b> Please press and hold the “<b>Paring</b>” button for 3 seconds to enter the pairing mode, the indicator light (red) flashes fast, the indicator light (red, green) will flash alternately after successful pairing.</p> <p>One click to exit pairing mode.</p>



## 7. Gateway connected to WiFi

### 7.1. Real-time Network Monitoring

The weather station can upload data to the following two platforms:

Application Services	Website	Description
Weatherseed APP	Wunderground.com	Our weather stations feature the most user-friendly design to monitor data across different platforms. Use our animated expandable modules to quickly view the details you want.
		

\*Weather station use the WiFi connection to send data to the Internet.

\* Please **DO NOT** fill in any credit card information on WU website. If a pop-up window appears when you open the Weather Underground website, please be careful and not to click it!

### 7.2.APP Download

Please search "Weatherseed " APP in Google Play or IOS App Store.

After downloading, you can follow the steps of WiFi connection to connect the weather station to WiFi and then view the data on the APP!

### 7.3.APP Account Register and Login

After successfully downloading “Weatherseed” APP, please open the APP, the first time you open the APP, the login or registration screen will appear. If you don't have an account for the first time, you need to register your own account to log in later; if you have already registered a Weatherseed account, you can log in directly without registering again.

#### 7.3.1. Registering Process

You can follow the steps and pictures below to register your Weatherseed account:

- (1) Fill in your e-mail address;
- (2) Send the verification code to the e-mail address;
- (3) Go to the e-mail address to check the verification code and enter it;
- (4) Set a password;
- (5) Confirm the password (must be consistent with the set password);

- (6) Check the user agreement and proof of age;
- (7) Register an account.

 **Note:** Your account will be automatically logged in the APP directly after the registration is completed.

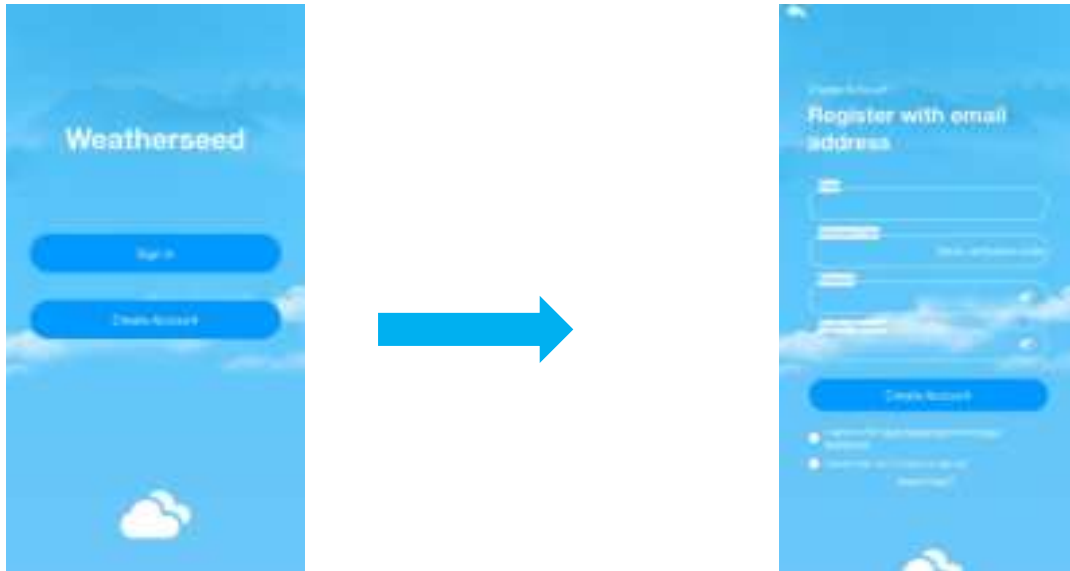

### 7.3.2. Login process

You can follow the steps and picture instructions below to log in to your Weatherseed account:

- (1) Enter your registered Weatherseed account (email address);
- (2) Enter the password you have set;
- (3) Check the User Privacy Agreement;
- (4) Log in to your account.

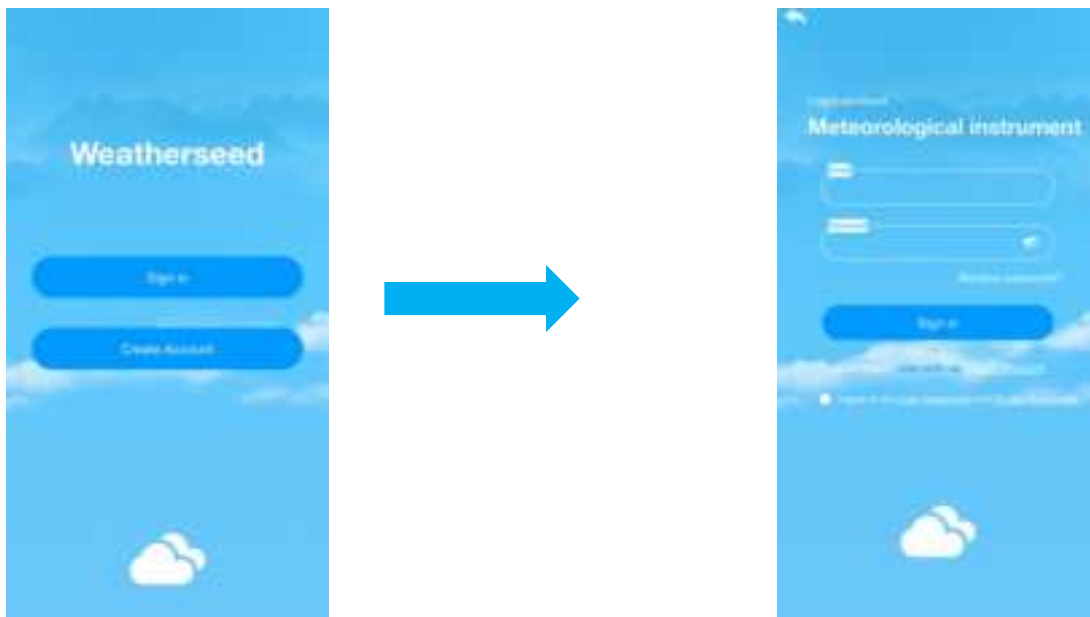

## 7.4. Connecting Steps

 **Note:** The weather station only supports 2.4 GHz signals. If you have a dual-band router (2.4 GHz and 5.0 GHz), please make sure that the router's 2.4 GHz band is turned on and can be distinguished from the 5.0 GHz channel's SSID for accurate connection to the 2.4 GHz channel.

 **Note :** The power adapter needs to be plugged into connect to WiFi.  
Battery power cannot connect to WiFi.

 **Note :** Please don't choose the wrong type and model , if you choose the wrong one, you can't match the network successfully.

 **Note:** The QR code is at the top of the Gateway.

### 7.4.1 Bluetooth Distribution Network Mode

Please press and hold the **“Internet”** button, the device will enter “Bluetooth distribution network” mode. After the gateway enters the “Bluetooth distribution network” mode, please open the APP to start networking:

Select the second icon  on the lower left to enter the networking interface to start networking, the specific steps and picture instructions are as follows:

(1)Enter the networking interface, click "Add Device" to start connecting the wifi ;



(2) Add the device in the app, select the device type and model, and set a weather station name, enter your location.

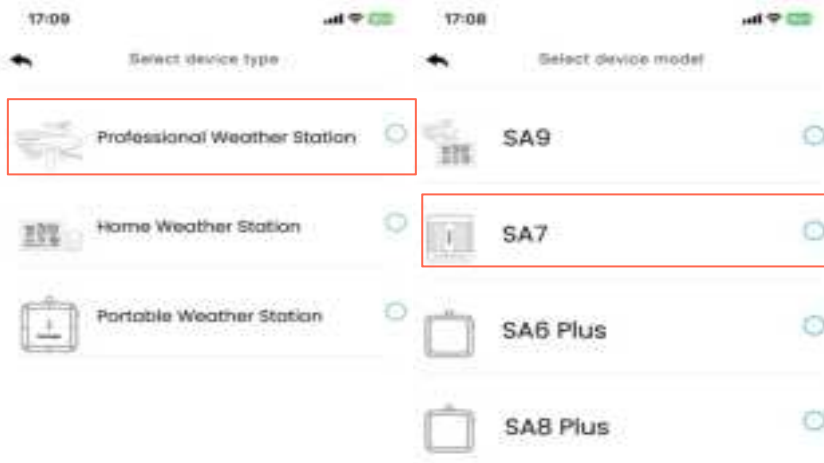



(3) Enter the network configuration interface and click “Next” to complete the three steps of network configuration. Then need to scan the QR code (Mac address) of the device.

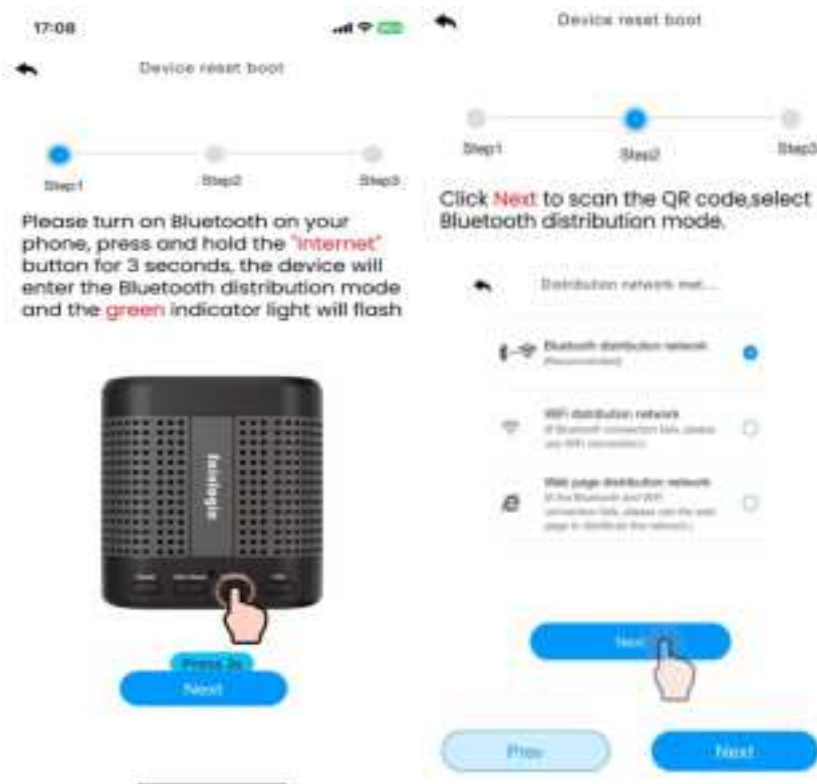



(4) Select “Bluetooth distribution network” mode to automatically search for Bluetooth signals and pairing.

After successful pairing, jump to WiFi interface. Please select 2.4Ghz WiFi and enter the password.



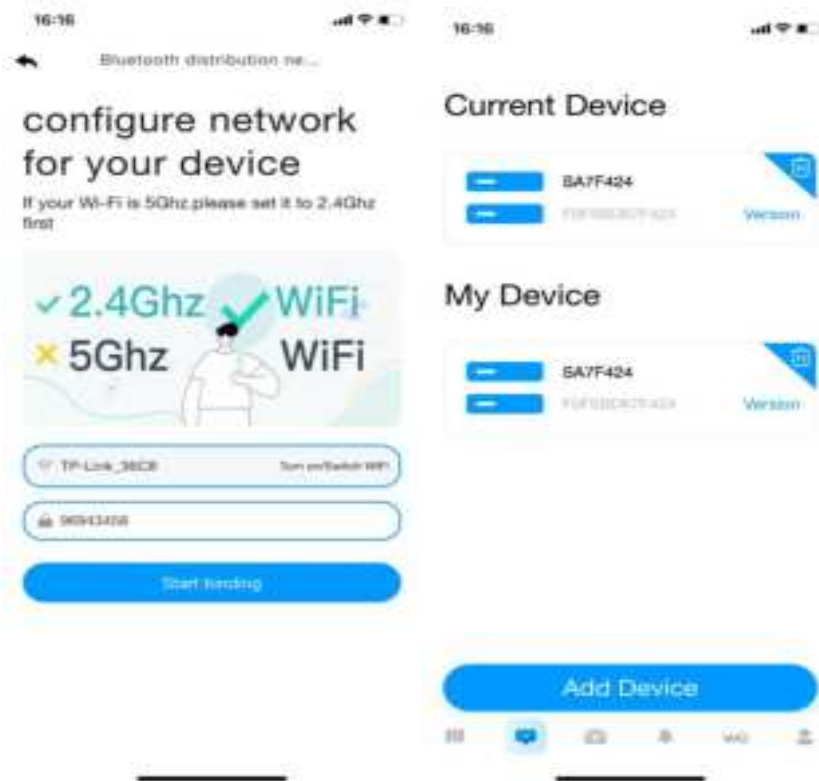

#### 7.4.2. Wifi Distribution Network Mode

Please press and hold the **“Internet”** button, the device will enter “Bluetooth distribution network” mode. Then please long press the button again for at least 3 seconds, the device will enter “WiFi distribution network” mode, the indicator light (green) will blink once in 1s.

After the gateway enters the “WiFi distribution network” mode, please open the APP to start networking:

(1)Enter the networking interface, click "Add Device" to start connecting the wifi ;



(2) Add the device in the app, select the device type and model, and set a weather station name, enter your location.

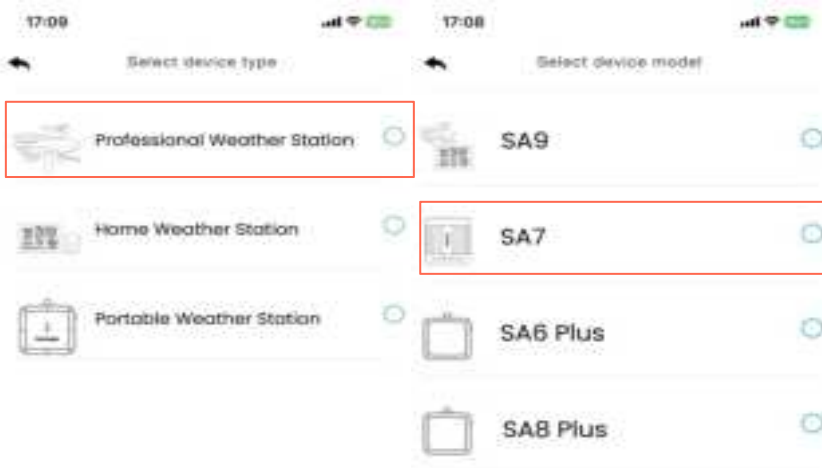





(3) Enter the network configuration interface and click “Next” to complete the three steps of network configuration. Then need to scan the QR code (Mac address) of the device.





(4) Select the distribution network mode: "WiFi distribution network".

Select your own WiFi (2.4Ghz), enter the correct password and connect the device. After the connection is successful, you will go back to Device page.

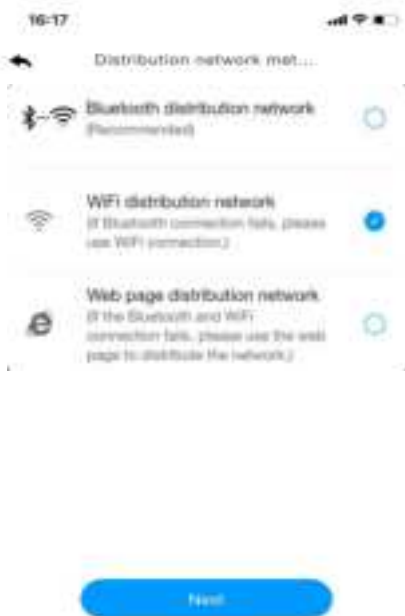



### 7.4.3. Web page distribution network mode

Please press and hold the third button to enter the distribution network mode, the device will enter “Bluetooth distribution network” mode. Then please long press the button again for at least 3s, the device will enter “WiFi distribution network” mode.

In “WiFi distribution network” mode, press and hold again for 3s to enter “Web page distribution network” mode, the indicator light (green) will blink once in 2s.

After the gateway enters the “Web page distribution” mode, please open the APP to start networking.

(1) Add device in the dashboard interface. Select device type and model, and set a weather station name, enter your location. Enter the network configuration interface and click Next to complete the three steps of network configuration.

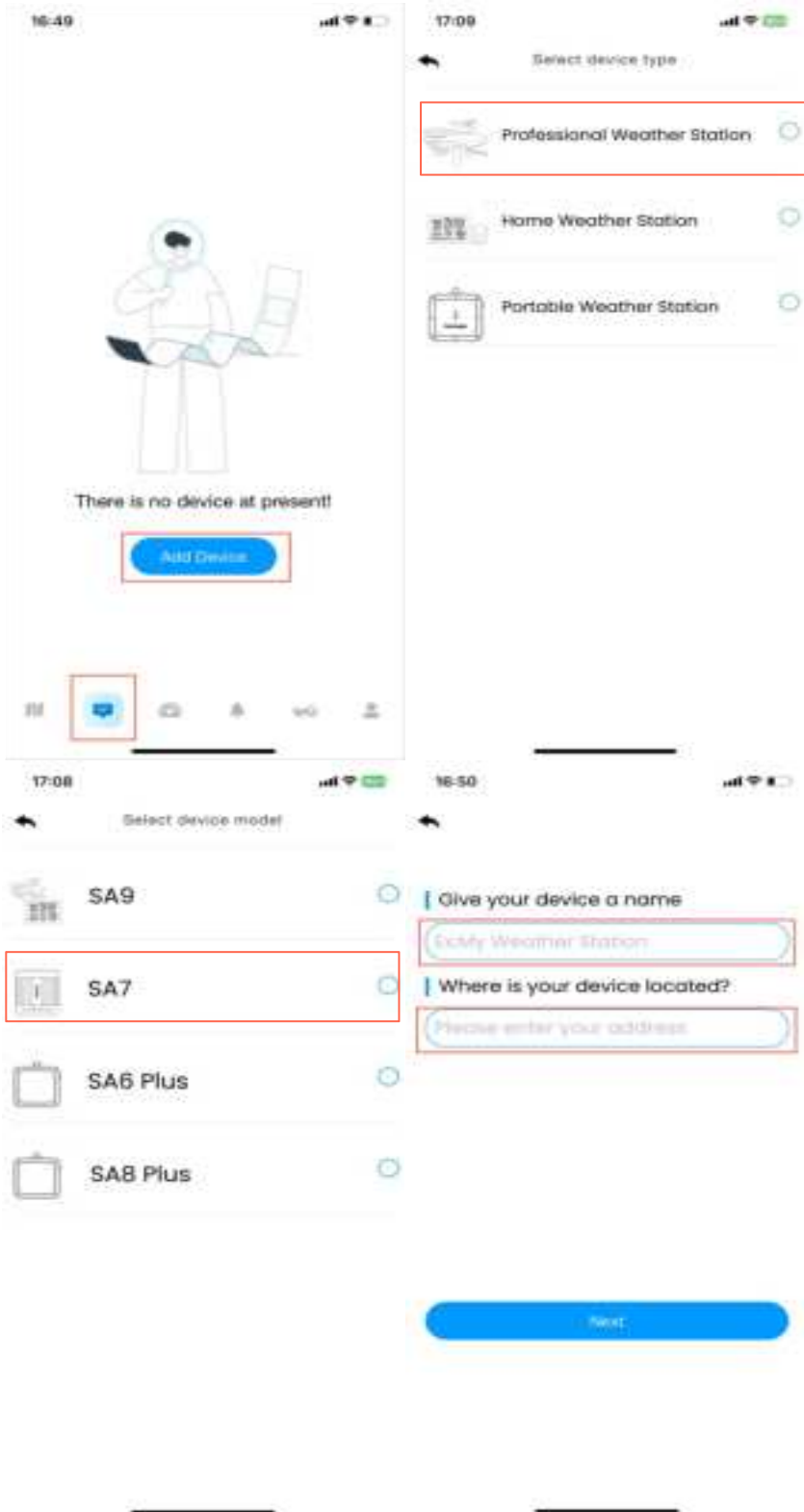

(2) Enter the network configuration interface and click "Next" to complete the three steps of network configuration. Scan the QR code.

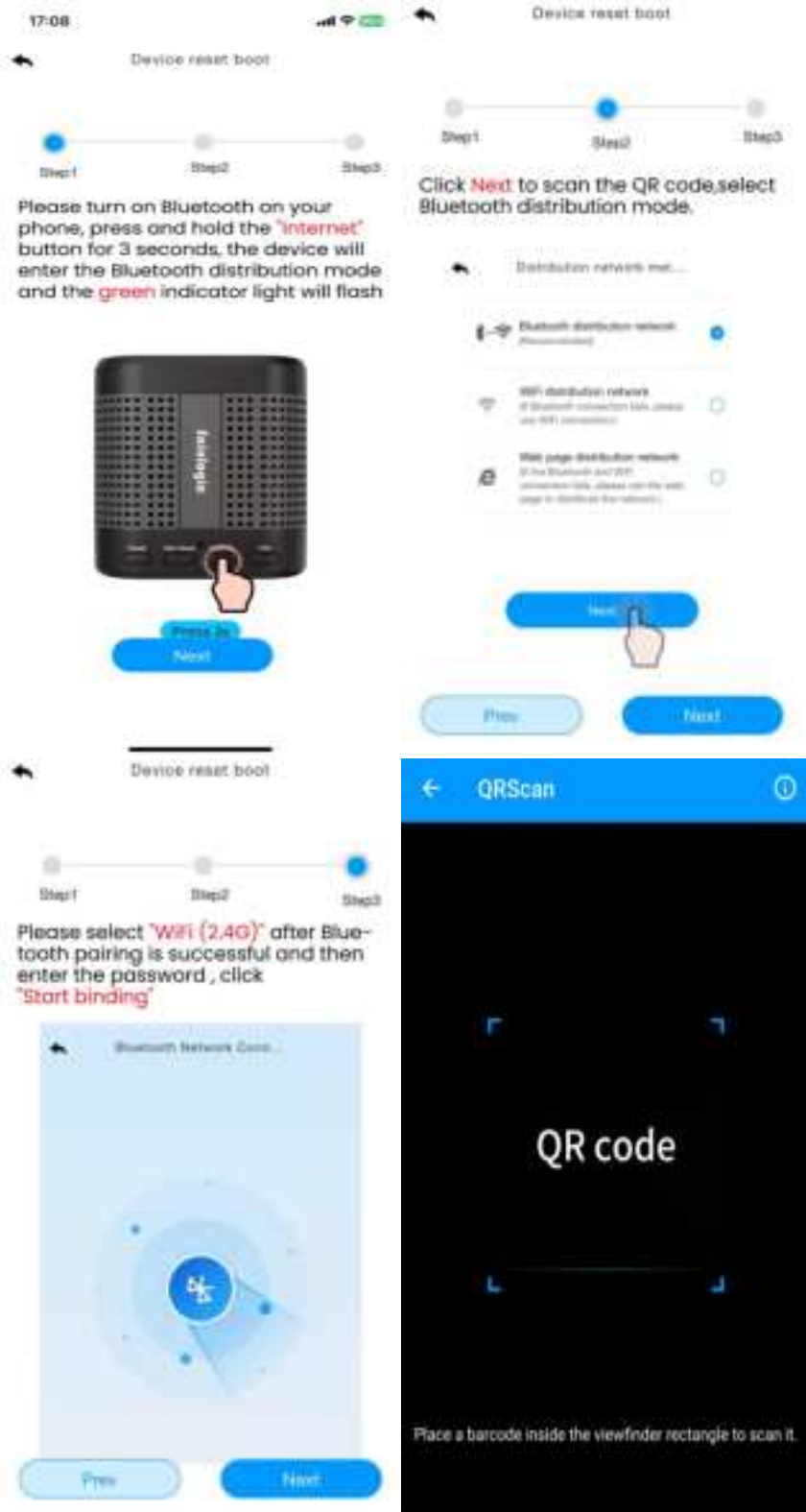

(3) Select the "Web page distribution network" mode, Click Go to connect WiFi. Then will automatically jump to the WiFi list screen, click Connect "weatherseed" WiFi.

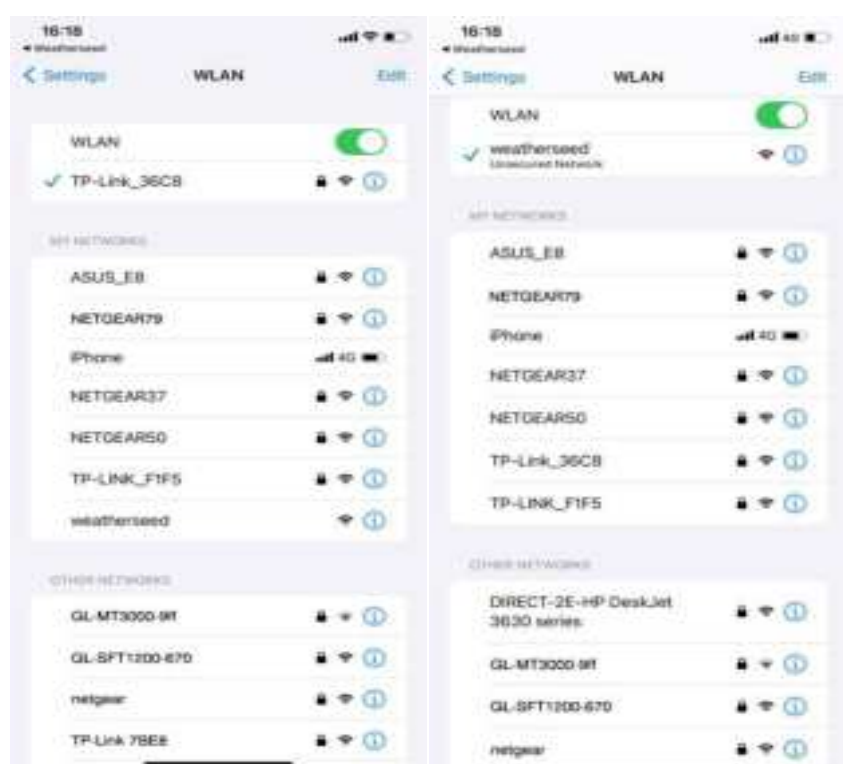
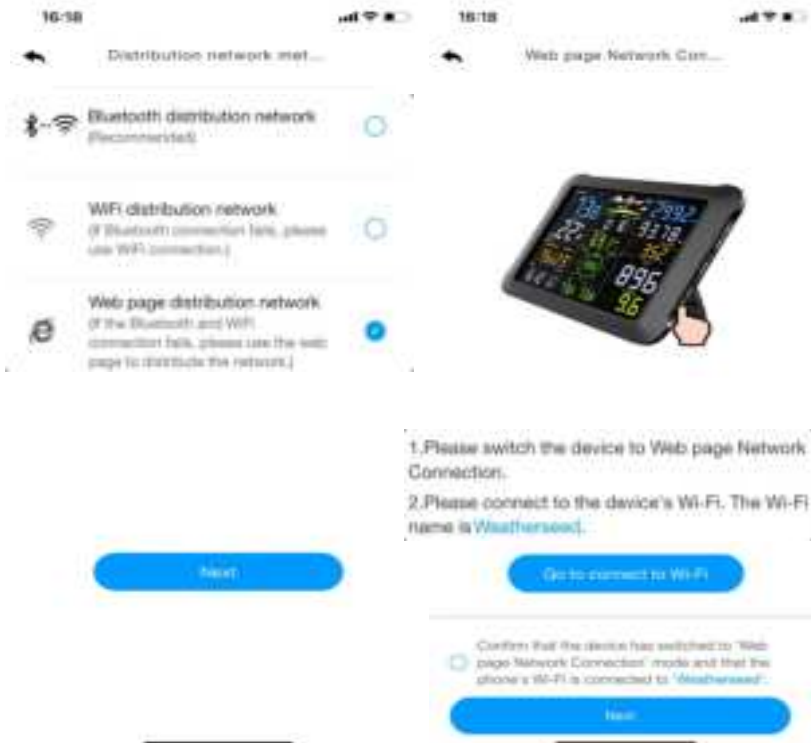

Return to the app, click the confirmation dot and click "Next". Please select 2.4Ghz WiFi, enter the password and click "Connect".

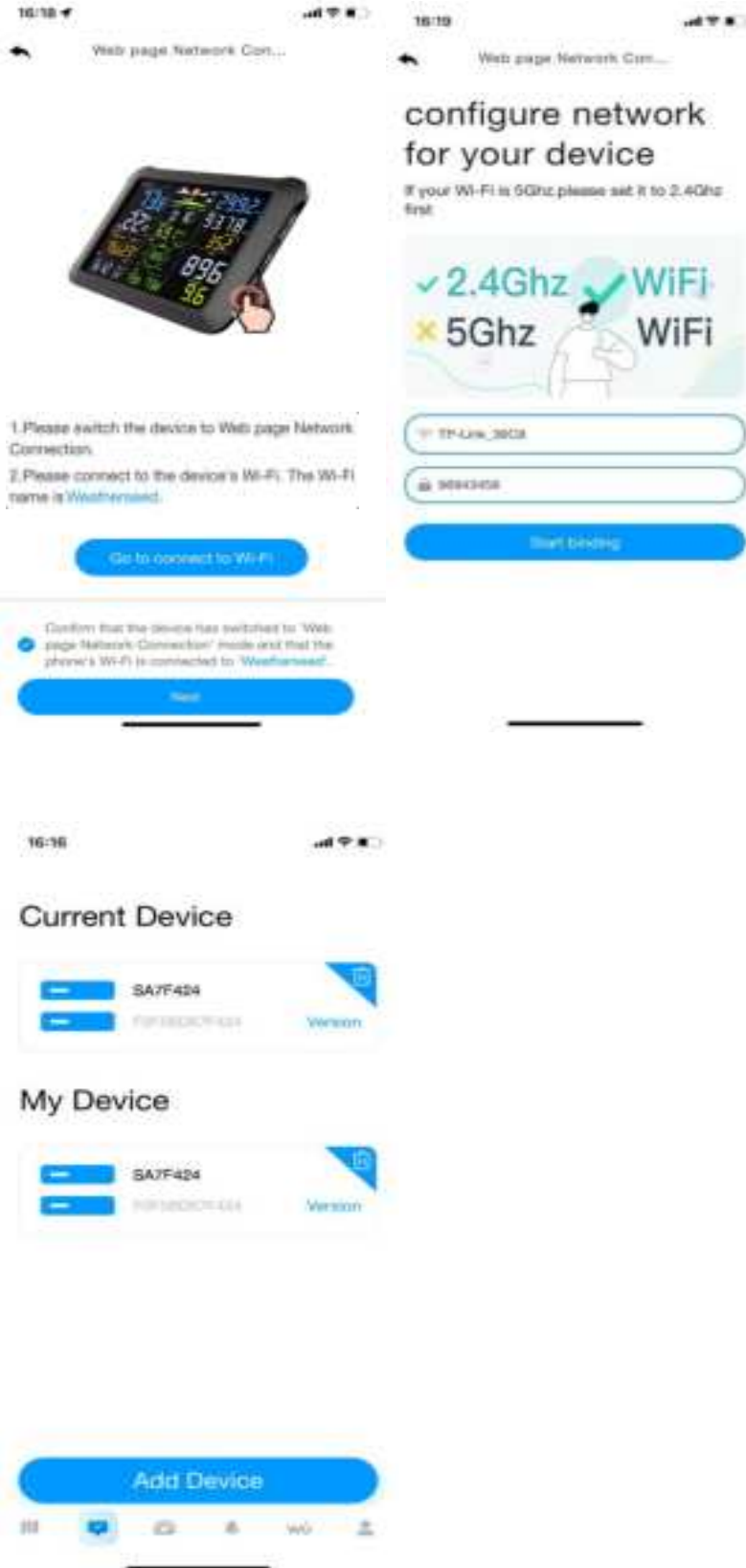

 **NOTE:** Android system can select WiFi. IOS system needs to manually enter the WiFi name.

## 7.5.Firmware Upgrade

When your app receives a firmware upgrade notification, follow the steps below to remotely upgrade the firmware.





## 7.6. Sign up on Wunderground.com

1. Visit the “<https://www.wunderground.com>” website, and click “Join” button, input the Email and password, and select “Sign up for free” button to create your own account.

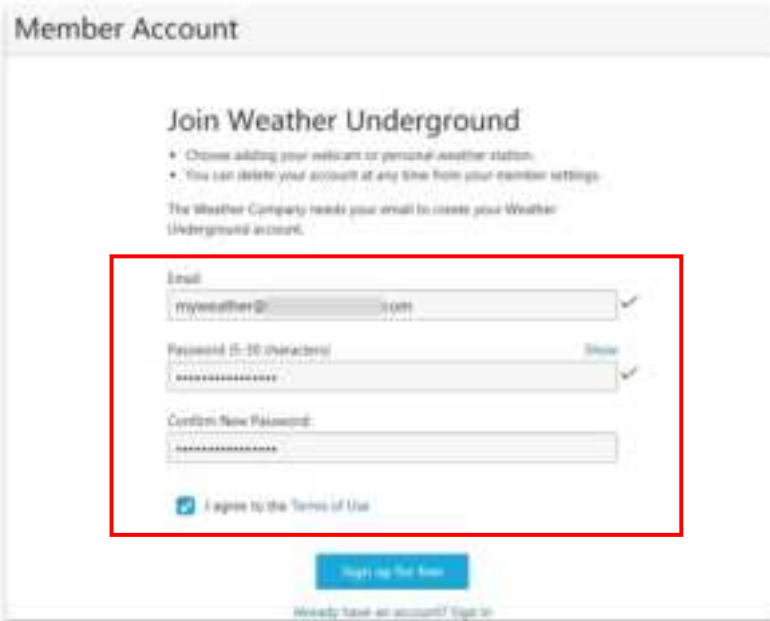
A screenshot of the "Join Weather Underground" registration page. The page title is "Join Weather Underground". Below the title, there are two bullet points: "• Choose adding your webcam or personal weather station." and "• You can delete your account at any time from your member settings." A note states: "The Weather Company needs your email to create your Weather Underground account." The registration form includes three input fields: "Email" (containing "myweather@...com"), "Password (5-30 characters)" (with a "Show" link), and "Confirm New Password:". Below the fields is a checkbox labeled "I agree to the Terms of Use". A blue "Sign up for free" button is at the bottom. A red box highlights the three input fields and the checkbox.

2. Click “Sign in” button to login, and switch to **Member Settings** page.

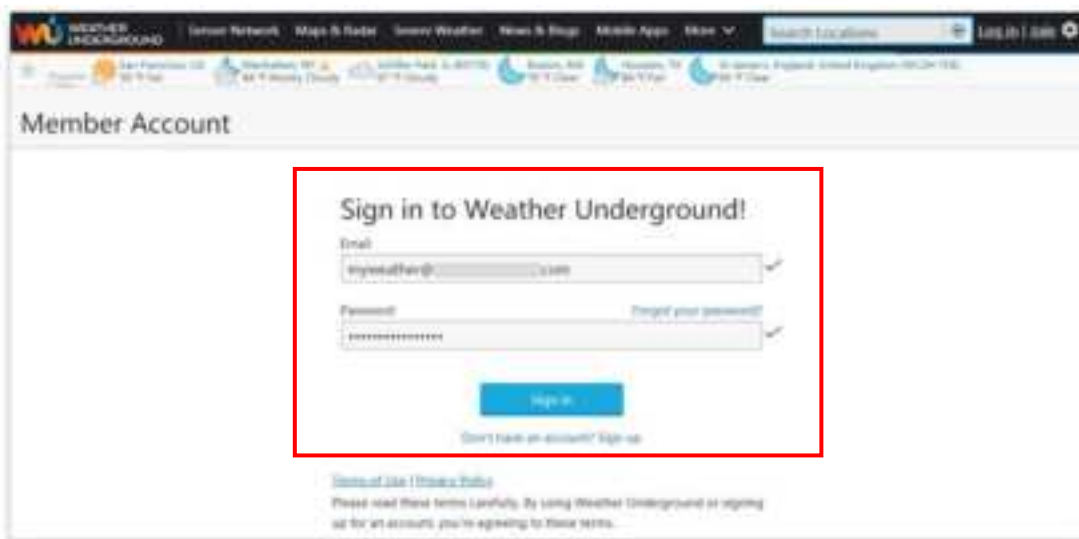
A screenshot of the "Sign in to Weather Underground!" login page. The page title is "Sign in to Weather Underground!". The login form includes two input fields: "Email" (containing "myweather@...com") and "Password" (with a "Forgot your password?" link). A blue "Sign in" button is at the bottom. Below the button is a link: "Don't have an account? Sign up". A red box highlights the two input fields and the "Sign in" button.

3. Select **My Devices** tab and click “Add New Devices”.

**Note:** in “Add New Devices” page, set the “TYPE”, “LOCATION”, “DETAILS” and “DONE” page step by step until 100% completion.

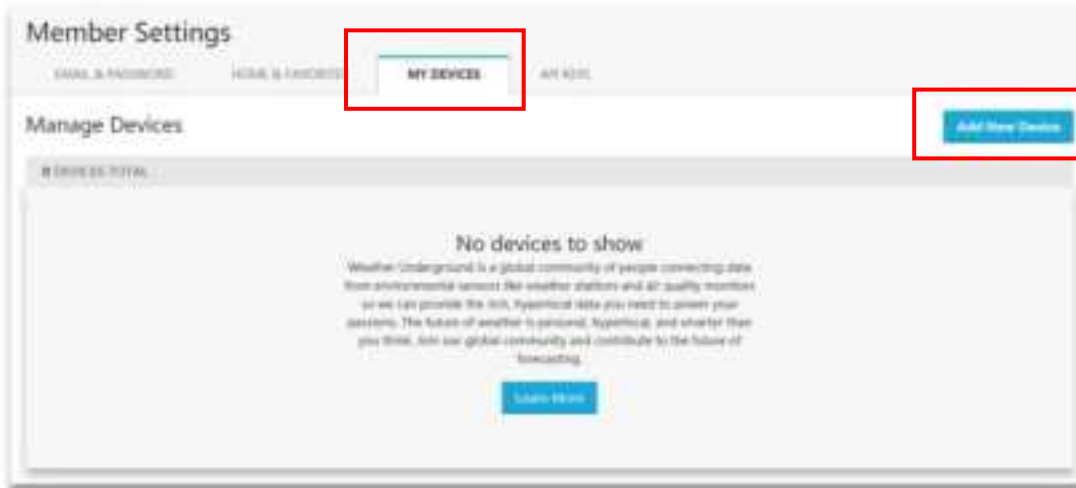

4. In **TYPE**

Page, click “**Personal Weather Station**” drop down list to select “**Other**”.

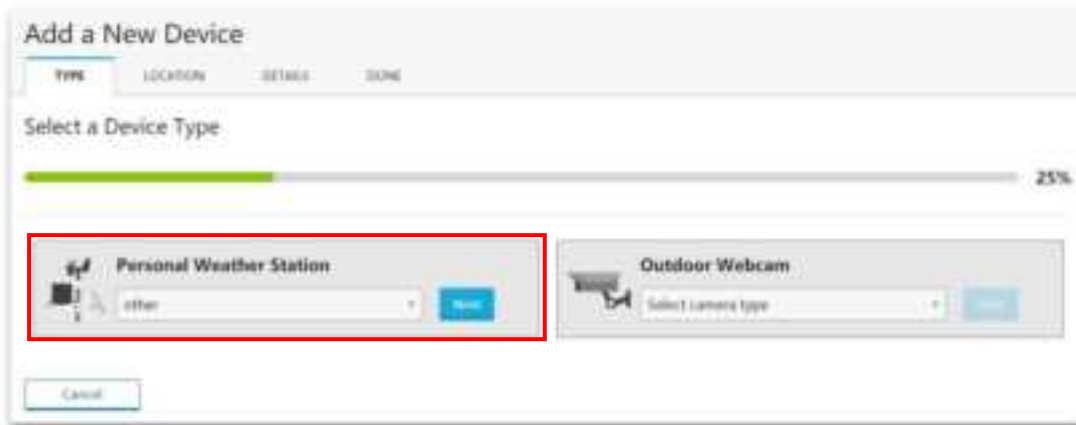

5. In **LOCATON** Page, Select “**Address**” or “**Manual**” Option, find and input your local position and press “**Next**”.

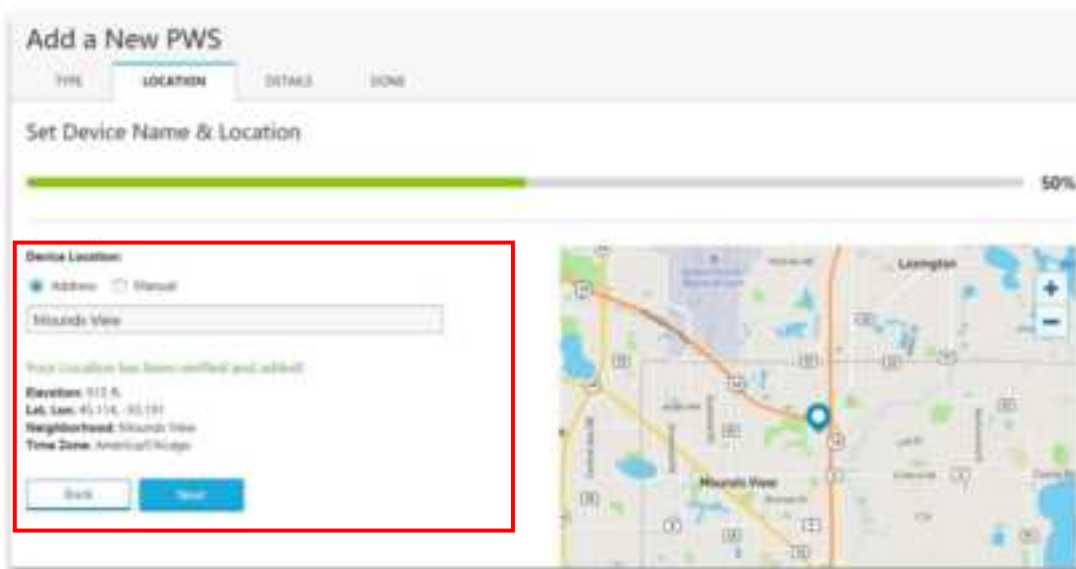

6. In **DETAILS** Page ,Fill in the “**Required**” information and Press “**Next**”.

**Add a New PWS**

TYPE LOCATION **DETAILS** DONE

Tell Us More About Your Device

75%

**Name (Required)**  
W00007

**Station Type**  
[Dropdown]

**Brand (Required)**  
EBS

**Access Method**  
[Dropdown]

**Device Hardware (Required)**  
[Dropdown]

**Height Above Ground**  
[Dropdown]

**You Make Our Forecasts More Accurate. We Respect Your Privacy**  
 Continue to the Weather Underground community by sharing some information about yourself and your device. We use this information to manage your account and to increase the experience from the Weather Underground community. We may also share certain data for commercial purposes, such as your device location.  
 Learn more about how we take your privacy seriously

I Accept  I Deny

**Send Notifications**  
 I would like to receive PWS notifications

7. In **DONE** Page, the device “**Station ID**” and “**Station Key**” are shown, copy and record the information for later use.

**Weather Underground** | Search Locations | My Profile

**Add a New PWS**

TYPE LOCATION DETAILS **DONE**

Registration Complete!

100%

Congratulations! Your personal weather station is now registered with Weather Underground.  
 Enter the information below to your weather station software.

**Your PWS**  
 Station ID: [Redacted]  
 Station Key: [Redacted]

**Configure Your Software**

## 8. Time Zone

The following table summarizes time zones around the world:

Hours from GMT	Time zone	Cities
-12	IDLW: International Date Line West	---
-11	NT: Nome	Nome, AK, USA
-10	AHST: Alaska-Hawaii Standard CAT: Central Alaska HST: Hawaii Standard	Honolulu, HI, USA
-9	YST: Yukon Standard	Yukon Territory
-8	PST: Pacific Standard	Los Angeles, CA, USA
-7	MST: Mountain Standard	Denver, CO, USA
-6	CST: Central Standard	Chicago, IL, USA
-5	EST: Eastern Standard	New York, NY, USA
-4	AST: Atlantic Standard	Caracas, Venezuela
-3.5	Newfoundland Time (NT)	Newfoundland, Canada
-3	---	São Paulo, Brazil
-2	AT: Azores	Azores, Cape Verde Islands
-1	WAT: West Africa	---
0	GMT: Greenwich Mean WET: Western European	London, England
1	CET: Central European	Paris, France
2	EET: Eastern European	Athens, Greece
3	BT: Baghdad	Moscow, Russia
3.5	Iran Standard Time (IRST)	Tehran, Iran
4	---	Abu Dhabi, UAE
5	---	Tashkent, Uzbekistan
5.45	Nepal Standard Time	Nepal
5.5	Indian Standard Time (IST)	India
6	---	Astana, Kazakhstan
7	---	Bangkok, Thailand
8	CCT: China Coast	Beijing, China
9	JST: Japan Standard	Tokyo, Japan
9.5	Australian Central Standard Time (ACST)	Adelaide, Australia
10	GST: Guam Standard	Sydney, Australia
11	---	Magadan, Russia
12	IDLE: International Date Line East NZST: New Zealand Standard	Wellington, New Zealand

## 9.Data Discussion

(1)

Temperature errors can occur when a sensor is placed too close to a heat source (such as a building/structure, the ground, or trees).

To calibrate temperature, we recommend a mercury or red spirit (fluid) thermometer. Bi-metal (dial) and digital thermometers (from other weather stations) are not a good source and have their own margin of error.

Using a local weather station in your area is also a poor source due to changes in location and timing (airport weather stations are only updated once per hour).

Place the sensor in a shaded, controlled environment next to the fluid thermometer and allow the sensor to stabilize for 48 hours.

(2)

Humidity is a difficult parameter to measure electronically and drifts over time due to contamination. In addition, location has an adverse effect on humidity readings (installation over dirt vs. a lawn, for example).

Official stations recalibrate or replace humidity sensors on a yearly basis. Due to manufacturing tolerances, the humidity is accurate to  $\pm 5\%$ . To improve this accuracy, the indoor and outdoor humidity can be calibrated using an accurate source, such as a sling psychrometer.

 **NOTE:** The measured humidity range is between 10% and 99%. Humidity cannot be measured accurately outside of this range. Therefore, it is not possible to calibrate humidity below 10% or above 99%.

(3)

The app shows two different pressures: absolute pressure (measured value) and relative pressure (corrected for sea level).

In order to compare air pressure conditions at different locations, meteorologists correct air pressure to sea level pressure. Because barometric pressure decreases with elevation, the sea level corrected pressure (the pressure at your location if you are at sea level) is usually higher than your measured pressure.

Thus, at an elevation of 1,000 feet (305 meters), the absolute barometric pressure may be 28.62 inHg (969 mb), but the relative barometric pressure is 30.00 inHg (1016 mb).

The standard sea level pressure is 29.92 inHg (1013 mb). This is the average sea level pressure for the entire world. A relative pressure measurement greater than 29.92 inHg (1013 mb) is considered high pressure, and a relative pressure measurement less than 29.92 inHg is considered low pressure.

To determine the relative barometric pressure at your location, look for an official reporting station near you (the Internet is the best source for real-time barometric conditions, such as the Weather.com or Wunderground.com websites) and set your weather station to match the official reporting station.

(4)

Wind speed is the most sensitive to installation constraints. The guideline for properly installing a wind speed sensor is 4 x the distance of the tallest obstruction. For example, if your house is 20' tall and you mount the sensor on a 5' pole:

$$\text{Distance} = 4 \times (20 - 5)' = 60'.$$

Many installations are not perfect, and installing the weather station on a roof can be difficult. Thus, you can calibrate for this error with a wind speed multiplier.

In addition to the installation challenges, wind cup bearings (moving parts) wear over time.

(5)

The rain collector is calibrated to the funnel diameter at the factory. The internal unit of the rain collector records 0.01 inches of rainfall (called resolution) for each pour. Accumulated rainfall can be compared to a sight glass rain gauge with an aperture of at least 4 inches.

The rain cycle view is calculated as follows:

View Period	Description	Example
1H	One hour delay from current time	If the current time is 08:25, the 1-hour rainfall refers to the rainfall from 08:25 to 09:25.
24H	Same time from current time to the day after	If the date is October 20 and the time is 08:25, the 24-hour rainfall is the amount of rainfall from 08:25 (10.20) to 08:25 (10.21).
Week	From the beginning of the week to the current time	If the current time is 08:25 on Thursday, the weekly rainfall refers to the rainfall from 00:00 on this Sunday to 08:25 on this Thursday.
Month	From the beginning of the month to the current time	If the current time is 08:25 on October 20, the monthly rainfall refers to the rainfall from 00:00 on October 1 to 08:25 on October 20.
Total	Total rainfall since the most recent start	If the start time is now October 20, 2024, then the total rainfall is October 20, 2024 to October 20, 2025.

 **NOTE:** Debris and insects can collect in the dump unit (they can form spider nests), so carefully remove the rain collector and check for debris in the dump unit before calibrating.

# 10. Feels Like Temperatures

The Feels Like Temperature is a combination of the Heat Index and the Wind Chill Index.

(1) When the air temperature is below 4.4°C (40°F), the Wind Chill Index is displayed, as shown in the following National Weather Service Wind Chill Index table:

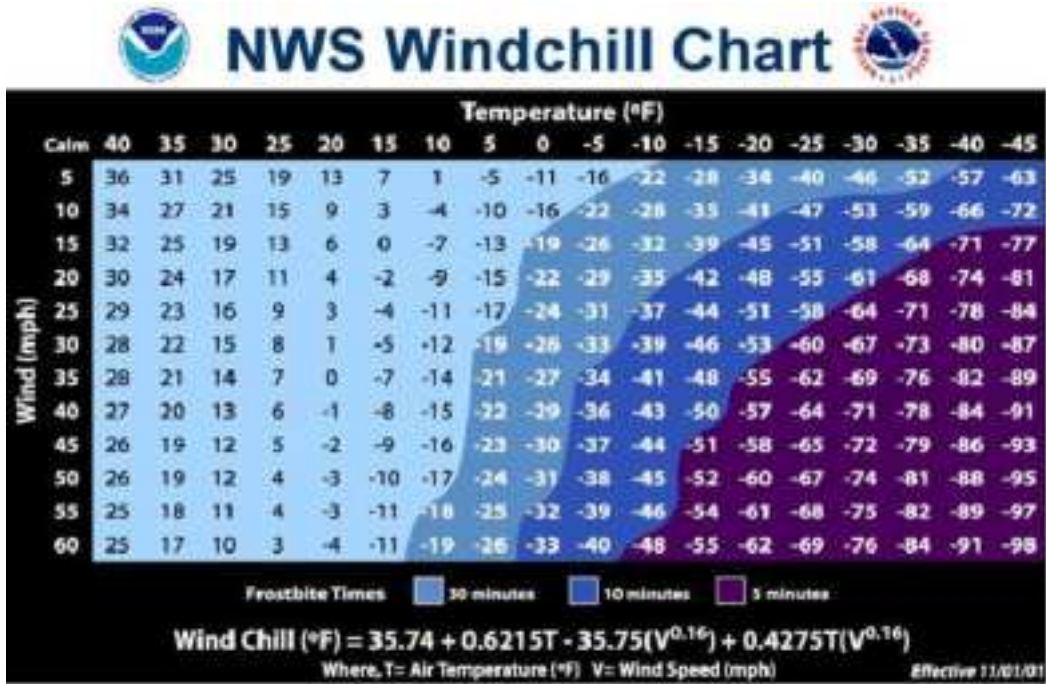

Figure 19

(2) When the temperature is above 26.7°C (80°F), the heat index is displayed, as shown in the following National Weather Service heat index chart:

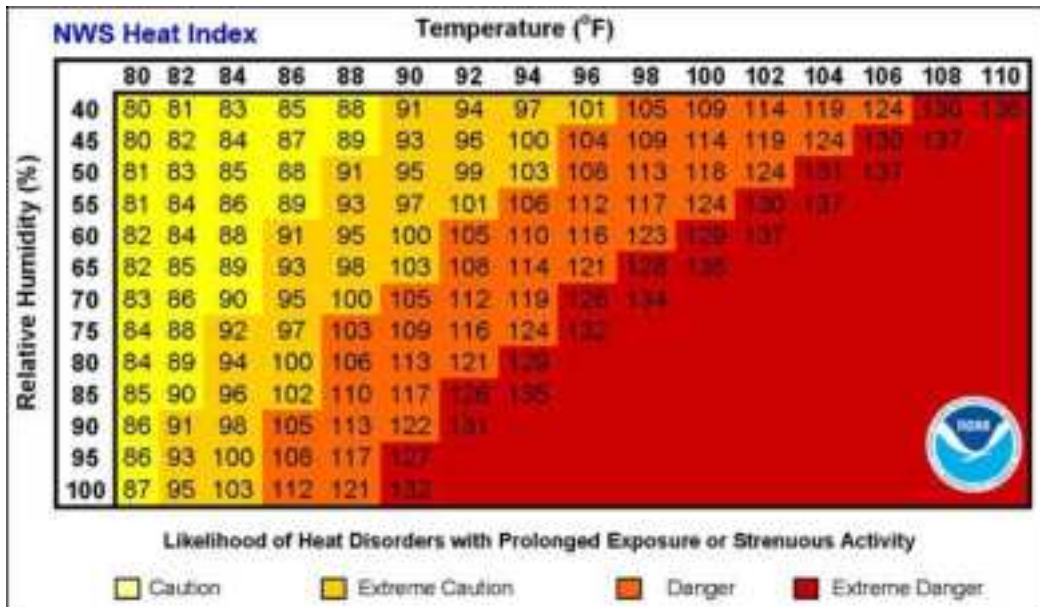

Figure 20

 **Note: Both the Wind Chill and Heat Index are displayed uniformly as it feels like.**

## 11. Glossary of Terms

Terms	Definition
Absolute pressure	<p>Absolute pressure is the measured atmospheric pressure and is a function of altitude and, to a lesser extent, changes in weather conditions.</p> <p>Absolute air pressure is not corrected for sea level conditions. See relative air pressure for details.</p>
Relative pressure	<p>The measured air pressure relative to your location or environmental conditions.</p>
HectoPascals (hPa)	<p>A unit of pressure measured in the SI (International System of Units). Same as the millibar (1 hPa = 1 mbar).</p>
Inches of Mercury (inHg)	<p>Pressure expressed in imperial units. (1 inHg = 33.86 mbar).</p>
Dew point	<p>Dew point refers to the temperature at which water vapor condenses into water after cooling in air of a certain humidity under constant air pressure. The condensed water is called dew, and the dew point is a saturation temperature.</p> <p>Dew point is related to relative humidity. A high relative humidity means the dew point is closer to the current air temperature. A relative humidity of 100% means the dew point is equal to the current temperature and the water in the air reaches maximum saturation. When the dew point remains constant and the temperature rises, the relative humidity decreases</p>



Rain gauge	<p>A rain gauge is a device that measures liquid precipitation (rain) over a period of time, rather than solid precipitation (snow, hail, or ice).</p> <p>All digital rain gauges are self-emptying or self-dumping (also called dumping rain gauges). The accuracy of a rain gauge depends on the amount of rain that falls during each emptying cycle.</p>
Accuracy	Precision is defined as the ability of a measurement to match the actual value of the quantity being measured.
Range	Range is defined as the number and interval of measurable values.
Resolution	Resolution is defined as the number of significant digits (decimal digits) that can be reliably measured.
Wind vane	Wind direction refers to the direction the wind is blowing from. For example, if the display shows the wind direction as south, it means the wind is blowing from the south.

## 12. Specifications

### 12.1. Wireless specifications

Wireless transmission	Specifications
Line of sight wireless sensor array RF transmission (open air)	330 ft, 100 ft in most cases
Line of sight Wi-Fi RF transmission (open air)	80 ft
Outdoor sensor update frequency	60 sec
Sensor array RF frequency	433 MHz
Wi-Fi console RF frequency	2.4 GHz

### 12.2. Measurement Specifications

The table below provides the specifications of the measured parameters.

Measurement	Range	Accuracy	Resolution
Indoor Temperature	0 to 60 °C (32 to 140°F)	± 1 °C (± 2°F)	0.1 °C(°F)
Outdoor Temperature	-40 to 60 °C	± 1 °C	0.1 °C(°F)

	(-40 to 140°F)	(± 2°F)	
Indoor humidity	10 to 99 %	± 5% (only guaranteed between 20 to 90%)	1%
Outdoor Humidity	10 to 99 %	± 5% (only guaranteed between 20 to 90%)	1%
Rainfall	0 to 9999mm	<15mm: ±1 mm, 15mm to 9999mm: ±7%	<1000mm (0.3mm) >1000mm (1mm)
Wind direction	0 - 360°	± 10° (16 point compass)	± 1° (16 point compass)
Wind Speed	0 to 50 m/s	2 m/s ~10 m/s:±0.3m/s , 10m/s ~50 m/s: ±10% (whichever is greater)	0.1 m/s
Barometric Pressure	300 to 1100 hpa	± 3 hpa	0.1 hpa

### 12.3. Power Consumption

Gateway	Power adapter plugged in to use
Integrated Outdoor Sensor:	3xAA alkaline or lithium batteries (not included) provide backup power when solar power is limited.   Note: Solar panels can charge the batteries.
Power Adapter	5V-1000mA (Included)

<p>Battery Life</p>	<p>If the base station signal reception is good, the transmitter battery can last at least 3 months. If the base station reception signal is intermittent, the transmitter battery life may be reduced.</p> <p>We recommend using lithium batteries for the transmitter in cold climates below -20°C (-4°F).</p>
---------------------	------------------------------------------------------------------------------------------------------------------------------------------------------------------------------------------------------------------------------------------------------------------------------------------------------------------

### 13. Maintenance

(1) We recommend cleaning the rain gauge once every 3 months. Twist the funnel clockwise and lift it vertically to expose the rain gauge assembly (see the image below). Then wipe the internal rain gauge assembly with a damp cloth to remove any dirt, debris, or insects. If insect infestation is a concern, you can lightly spray the array with an insecticide.

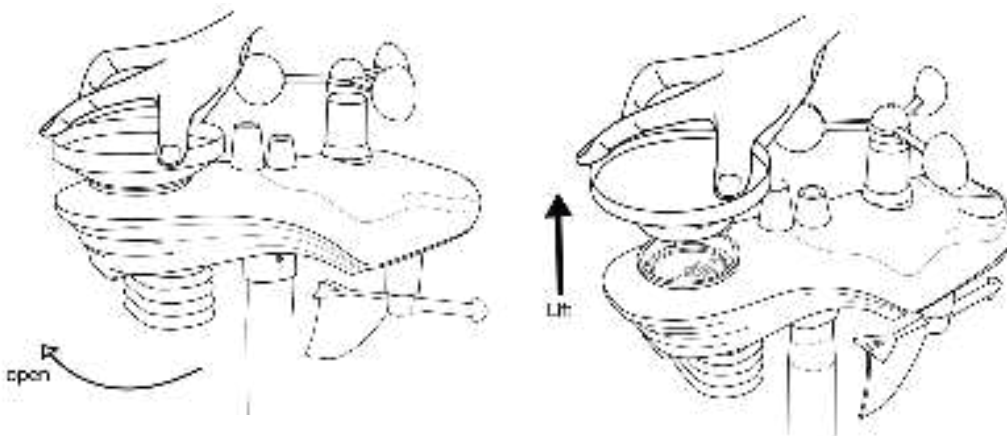

Figure 21

- (2) Clean the solar panel with a damp cloth every 3 months. Replace the battery every 3 months. If left for too long, the battery may leak due to environmental factors. In harsh environments, check the battery every 3 months (when cleaning the solar panel).
- (3) When replacing the battery, apply anti-corrosion compound to the battery terminals, which is available on Amazon and most hardware stores.
- (4) In snowy conditions, spray the top of the weather station with anti-icing silicone spray to prevent snow accumulation.
- (5) Over time, the smoothness of the rain gauge funnel surface will degrade due to dirt, debris. Therefore, we recommend spraying Teflon spray on the rain gauge funnel and coil filter to reduce the surface tension of the water.

## 14. Troubleshooting Guide

If your question is not answered here, you can contact us by Customer Support Email, Customer Support Phone and Website:

(1) Customer Support Email: [info@sainlogic.com](mailto:info@sainlogic.com)

(2) Website: <https://www.sainlogic.com/>

Customer Support Phone: +1 (888) 513-9823 (Mon-Fri 10 a.m. - 6 p.m, EST)

Problem	Solution
<p>Outdoor/Indoor data is not shown in the APP</p>	<p>If the device is online, but the data still not be displayed on the app. Please follow the instructions below to troubleshoot.</p> <ol style="list-style-type: none"> <li>1. Please press and hold the first button for 3 seconds, the gateway will disconnect the pairing with the transmitter.</li> <li>2. Then please reset the transmitter.</li> </ol> <p>After the transmitter is powered on, if the indicator light blinks every 60 seconds it means the outdoor unit is working properly.</p> <p>After the transmitter is powered on and working properly, the display has to be re-plugged in to re-receive the transmitter signal. It usually takes 1-3 minutes to receive the data, do not operate the keys or power off until the transmitter data is received.</p> <p>Install a new set of batteries for the remote sensor. In cold weather environments, install lithium batteries.</p> <ol style="list-style-type: none"> <li>3. Plug in the device with the power adapter.</li> </ol> <p>Please press and hold the fourth button for 3 seconds to enter the pairing mode, the indicator light (red) flashes fast, the indicator light (red, green) will flash alternately after successful pairing.</p> <ol style="list-style-type: none"> <li>4. If the device shows offline on the app, you need to reconnect to WiFi.</li> </ol>
<p>Rainfall display is incorrect/zero</p>	<p>Please check and verify the following points when you</p>

find you rainfall is not working or inaccurate:

1. Make sure that the level bubble is seated in the small black circle in the installation. Sloping installation might cause incorrect reading or even not working.

2. Shake the sensor array back and forth. After hearing the click sound inside the sensor array, observe whether the rainfall reading in the console changes.

3. Check whether the funnel in the rain collector was blocked by tree leaves or debris. Remove the rain collector to check whether the rain tip was blocked by insects or debris.

4. Check whether different rainfall histories are correct. Check the Quick Mode part in the instruction manual to know how to get rainfall histories in different periods.

5. An example on how rainfall histories for different periods are calculated.

Presume that the current time is 08:42 22rd Sept. 2023

Rainfall Hour: 08:42-09:42

Rainfall Day: 08:42 on September 22 to 08:42 on September 23

Rainfall Week: 00:00 Sunday to 08:42 today

Rainfall Month: 00:00 1st Sept. to 08:42 today

Rainfall Total: Total rainfall amount from the latest powering on

6. How to verify the rainfall accuracy

A: Use a bottle containing 500g or 500ml of water.

B: Drip water slowly into the rain collector. DO NOT POUR WATER QUICKLY.

C. Observe the rainfall reading of the console after the water is completely dripped out. It should be 5.46cm +/-5%. (5.46cm=54.6mm)

7. The rain gauge could not measure rainfall below 0.3mm due to limited resolution.

 **Note: One transmitter can connect to multiple gateway of the same model, but one gateway cannot be connected to multiple transmitters at the same time.**

 **Note: Please carefully check whether the model is consistent before purchasing. If you have**

**any questions, please consult after-sales service in advance.**

## **15.Disclaimer**

Please protect the environment by returning used batteries to an authorized recycling station. Electrical and electronic waste contains hazardous substances. Disposal of e-waste in the natural environment and/or in unauthorized locations can damage the environment.

Reading the user manual is strongly recommended and the manufacturer and supplier cannot be held responsible for any incorrect readings or consequences resulting from failure to read the manual carefully.

This product is intended for home use only and is not intended for medical purposes or public safety information. This product is not a toy and should be kept out of the reach of children.

We assume no liability for accidental, consequential, punitive or other similar damages related to operation or malfunction.

## **16. Warranty Information**

Sainlogic provides a 1-year limited warranty against manufacturing defects in materials and workmanship on this product.

This limited warranty begins on the date of original purchase and is valid only for the product purchased and only for the original purchaser of this product. To obtain warranty service, the purchaser must contact Sainlogic to determine the problem and service procedure.

Warranty service can only be performed by Sainlogic. The original dated bill of sale must be presented to Sainlogic upon request as proof of purchase.

Sainlogic's warranty covers all defects in materials and workmanship except:

- (1) Damage caused by accident, unreasonable use or neglect (lack of reasonable and necessary maintenance);
- (2) Damage caused by failure to follow the instructions in the user's manual;
- (3) Damage caused by self-repair or alteration;
- (4) Equipment not intended for personal use;
- (5) Applications and uses of this product that do not correspond to the intended use;
- (6) The product is unable to receive signals due to any source of interference or metal obstruction;

If you need to register or apply for a warranty, please contact us by Customer Support.

Customer Support Email: [info@sainlogic.com](mailto:info@sainlogic.com)

Website: <https://www.sainlogic.com/>

Customer Support Phone: +1 (888) 513-9823 (Mon-Fri 10 a.m. - 6 p.m, EST)

## 17. FCC Statement

1. This device complies with Part 15 of the FCC Rules. Operation is subject to the following two conditions:

- (1) This device may not cause harmful interference, and
- (2) This device must accept any interference received, including interference that may cause undesired operation.

2. Changes or modifications not expressly approved by the party responsible for compliance could void the user's authority to operate the equipment.

NOTE: This equipment has been tested and found to comply with the limits for a Class B digital device, pursuant to Part 15 of the FCC Rules. These limits are designed to provide reasonable protection against harmful interference in a residential installation.

This equipment generates, uses and can radiate radio frequency energy and, if not installed and used in accordance with the instructions, may cause harmful interference to radio communications.

However, there is no guarantee that interference will not occur in a particular installation. If this equipment does cause harmful interference to radio or television reception, which can be determined by turning the equipment off and on, the user is encouraged to try to correct the interference by one or more of the following measures:

- ◆ Reorient or relocate the receiving antenna.
- ◆ Increase the separation between the equipment and receiver.
- ◆ Connect the equipment into an outlet on a circuit different from that to which the receiver is connected.
- ◆ Consult the dealer or an experienced radio/TV technician for help.

FCC ID:2A7KU-SA7

