

150*150mm
骑马钉

正面

①

②

③

④

⑤

⑥

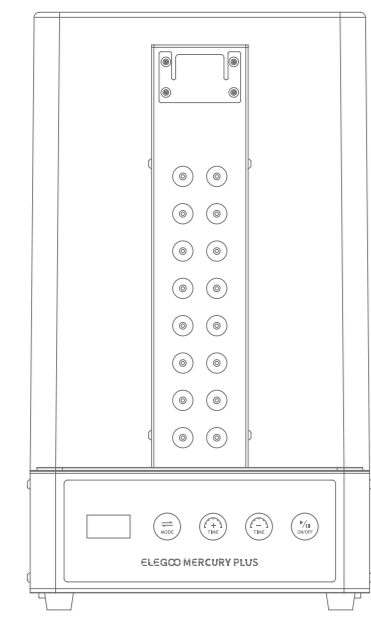

ELEGOO MERCURY PLUS
Operation Manual for
ELEGOO MERCURY PLUS Wash & Cure Machine
ELEGOO

Thank you

Please unbox and inspect the machine upon receiving it. If you have any questions regarding the machine, please contact us at 3dp@elegoo.com facebook and ins.

Please read the instruction carefully before you use the machine.

Multiple language instructions and software are available to download from www.elegoo.com/download.



Notice:

Please always keep in mind the precautions when using the ELEGOO MERCURY PLUS Wash & Cure Machine. Failure to comply with these precautions may cause the damages to the machine or even cause individual injury.

- Please contact our customer service first to arrange replacement if any parts are found damaged or missing after receiving the products.
- Do not place the model directly in the cleaning bucket. Please leave the model on the build platform and wash them together or place the model in the cleaning basket and then wash it.
- Please follow the safety regulations and use and store the washing liquid (which could be ethyl alcohol or isopropanol) properly. Do not exceed the maximum line when adding washing liquid, otherwise, the washing liquid may spill out and cause damages to the machine. Please cover the cleaning bucket with lid and keep the washing liquid well stored after use.
- Please wash and dry the model first before curing, otherwise, the model would be covered with some white residues, sticky or cracked.
- Do not take away the lid from the machine when curing mode is on as to prevent potential hazards from the UV light.
- After long-hour use in the curing mode, it is normal that the temperature of the machine body and the cover will rise.
- Please adjust the curing time appropriately if the model turns yellow after curing. Over curing will lead to the model yellowing.
- ELEGOO MERCURY PLUS Wash & Cure Machine is designed to be used within ambient temperature ranging from 0°C to 40°C, and humidity ranging from 20% to 50%.
- Do not disassemble the ELEGOO MERCURY PLUS Wash & Cure Machine without consulting. Please contact ELEGOO customer service: 3dp@elegoo.com if you have any problems.

Technical Specification:

Machine Name: ELEGOO MERCURY PLUS Wash & Cure Machine

Control Method: Touch button

Rated Power: 48W

Input Voltage: 100V-240V 50/60Hz

UV Light: 385nm*405nm (9+8)

Time Setting: 0-30mins

Machine Size: 200mm*200mm*352mm

Maximum Wash Volume: 125mm*85mm*160mm

Maximum Curing Size: φ140*165mm

Machine Net Weight: 4.8kg

Curing Time Setting: For model with diameter less than 30 mm, the curing time is recommended to be 2 minutes. If the structure of the model is complex, it is recommended to increase the curing time properly.

Product Overview

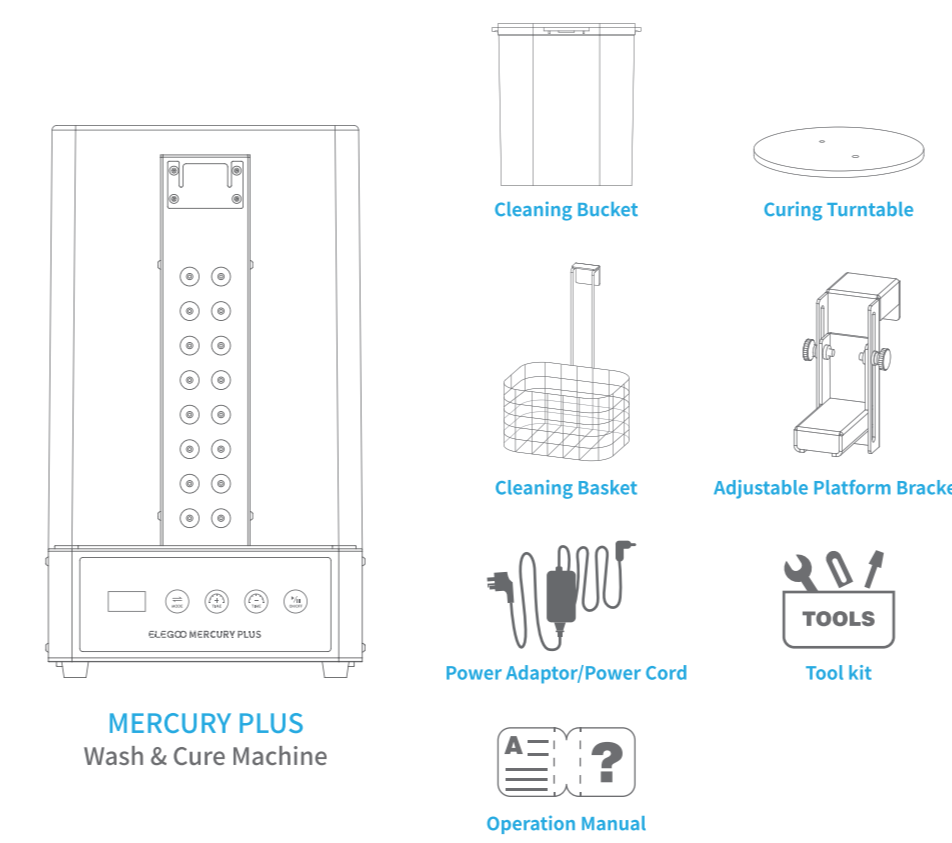

Product Overview

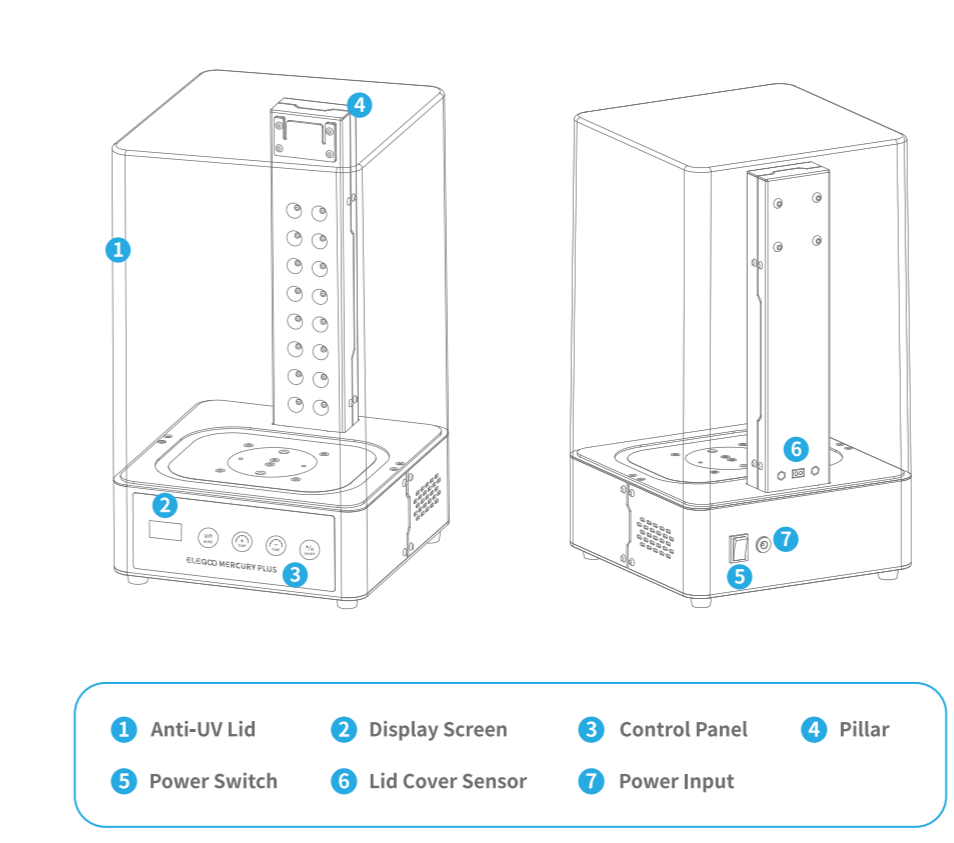

Product Overview

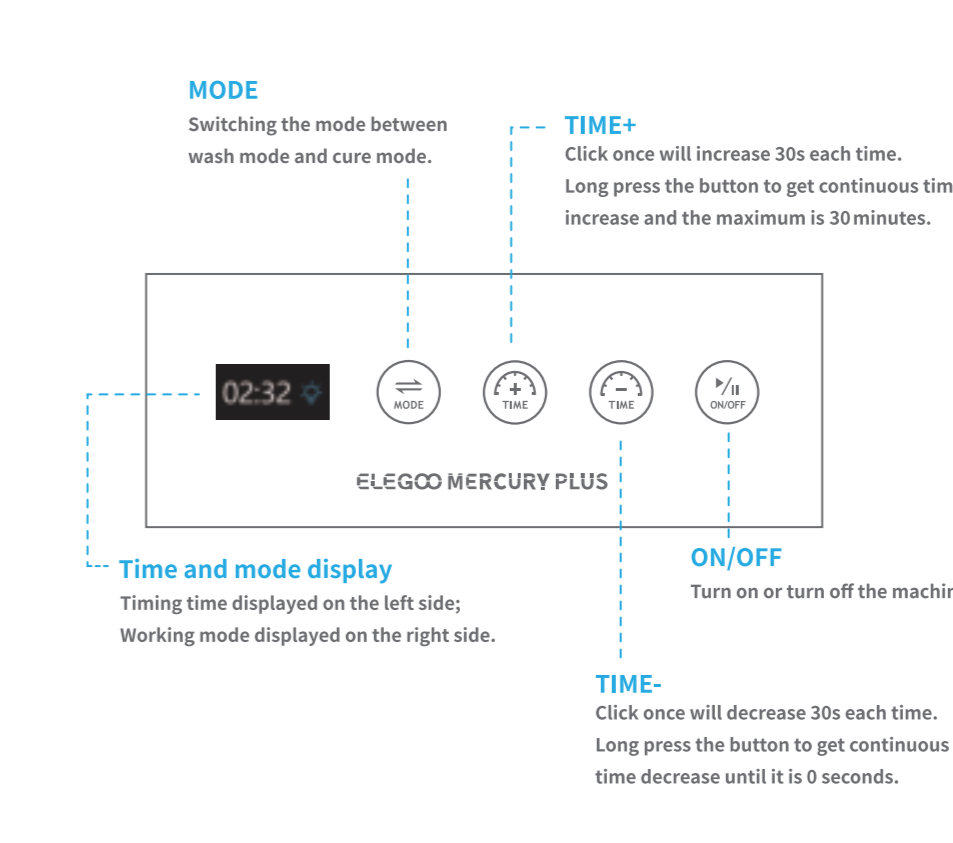

封面

⑦

⑧

⑨

⑩

⑪

⑫

13

(13页与背面为一页)

Operation Instruction

ELEGOO MERCURY PLUS Wash & Cure Machine has two working modes, wash mode and cure mode. Please plug in the power and turn on the machine before use.

4.1 Wash Mode

4.1.1. Switch the machine to "Wash Mode" by touching the "MODE" on the panel, at this time the display mode icon shows: [Picture 1]

4.1.2. Open the sealing lid of the cleaning bucket, add an appropriate amount of washing liquid (the height of the washing liquid must not exceed the maximum scale), then place the cleaning bucket in the positioning slot on the machine platform (please remove the curing turntable beforehand). [See Picture 1]

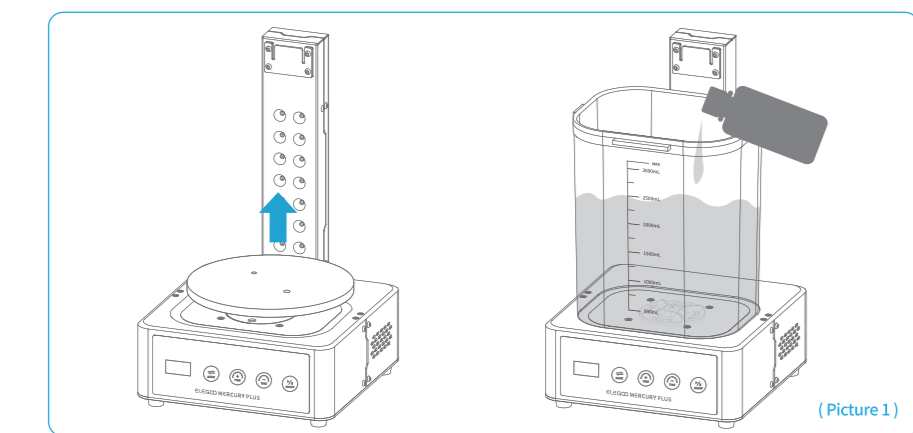

Operation Instruction

4.1.3. Submerge the model in the washing liquid of the cleaning bucket in a suitable manner (do not place and wash the model directly in the cleaning bucket, otherwise, the model and the cleaning bucket will be damaged).

a. If the printed model is not removed from the build platform, please mount the build platform to the adjustable platform bracket (the bracket length can be adjusted by hand-rotating nuts on both sides to accommodate different model heights and washing liquid heights, up to a maximum model height of 120 mm), then hang the adjustable platform bracket on top of the pillar. (Models less than or equal to 15 mm in size should be cleaned in this way.) [See Picture 2]

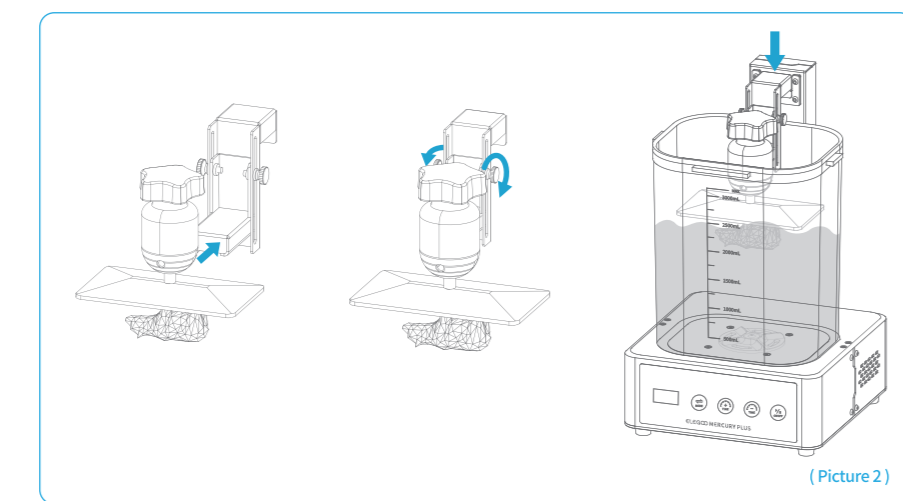

Operation Instruction

b. If the printed model has been removed from the build platform already, you will need to place the model in the cleaning basket (minimum model height is 100 mm) and hang the cleaning basket on top of the pillar. (Models larger than 15 mm in size are available with this cleaning option.) [See Picture 3]

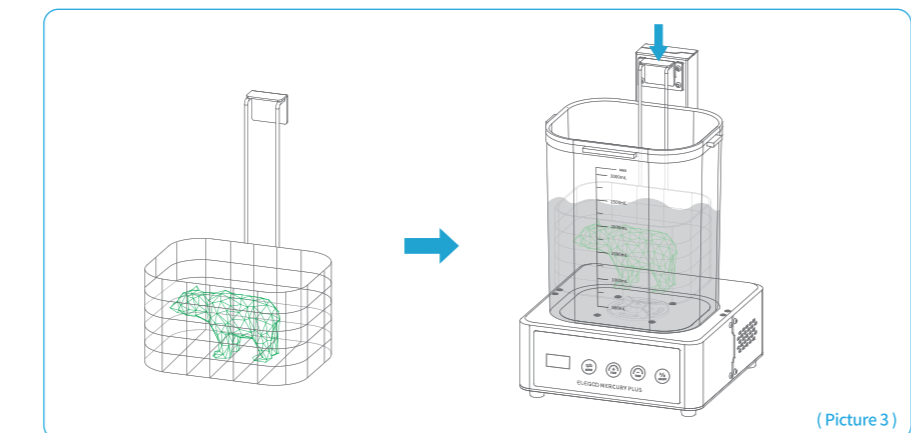

4.1.4. Then cover the anti-UV lid. Touch "TIME+" or "TIME-" to set the washing time. After that, touch "ON/OFF" to start cleaning the model.

4.1.5. The machine will beep when the cleaning is done. Please remove the model for air drying. After cleaning, remove the cleaning bucket and seal it with lid (washing liquid can be used multiple times). If washing liquid spills onto the machine, please clean it up quickly to avoid a short circuit caused by washing liquid flowing into the machine.

Operation Instruction

4.2 Cure Mode

4.2.1. Switch the machine to "Cure Mode" by touching the "MODE" on the panel, at this time the display mode icon shows: [Picture 4]

4.2.2. Place the curing turntable firmly against the turntable positioning hole in the center of the machine platform (please clean beforehand). [See Picture 4]

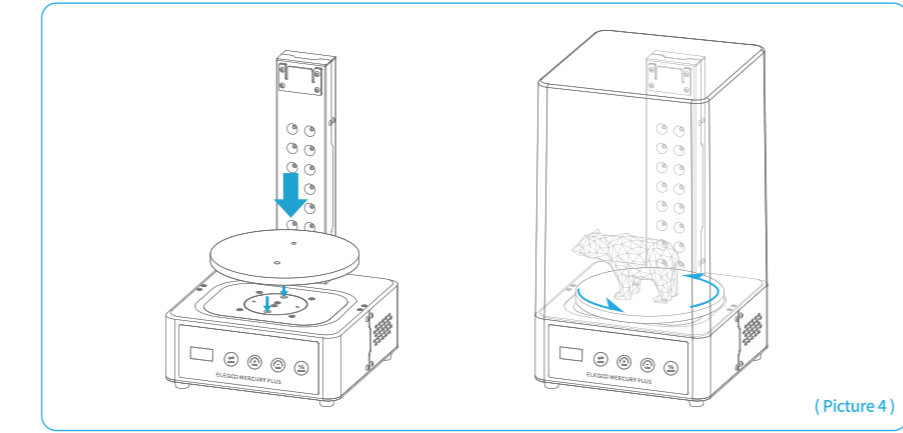

4.2.3. Place the model on the center of the curing turntable.

4.2.4. Then cover the anti-UV lid. Touch "TIME+" or "TIME-" to set the curing time. After that, touch "ON/OFF" to start curing the model. It is normal that there is a slight jitter due to the slow speed of the turntable.

4.2.5. The machine will beep when the curing is done.

Maintenance

5.1 Recycling of Washing Liquid

When the washing liquid in the bucket is reused for more than 30 times, we need to filter and clean the waste. First, leave the washing liquid to stand for about 10 hours, and then after the waste has settled to the bottom of the cleaning bucket, pour the washing liquid from the top of the bucket into another container, then clean the waste from the bottom of the bucket (the waste would be converted to ordinary solid waste in sunlight), if necessary, the bucket rotor can be removed for cleaning. [See Picture 5]

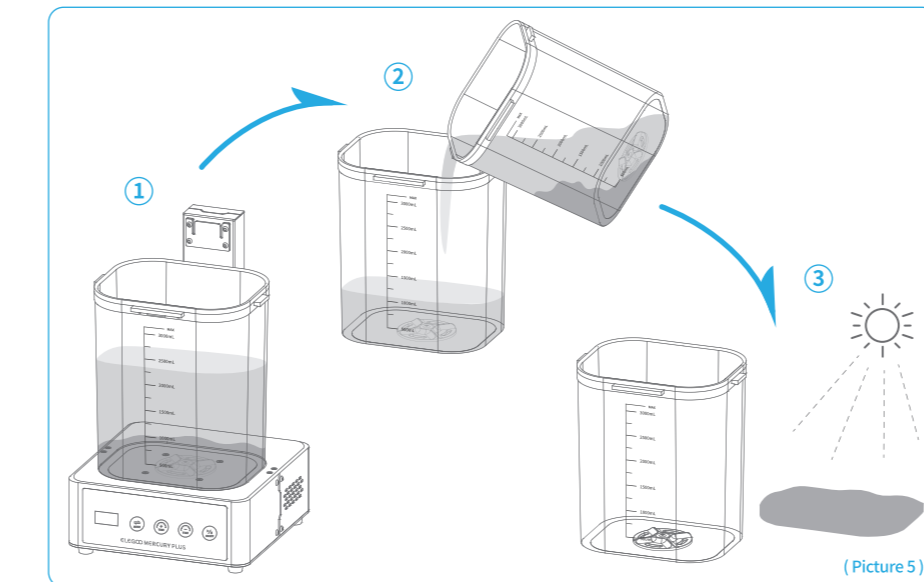

Maintenance

5.2 Cleaning the Rotor of the Cleaning Bucket

After a period of use, the bottom rotor of the cleaning bucket may rotate abnormally due to the precipitation, at which point the rotor can be removed for cleaning. [See Picture 6]

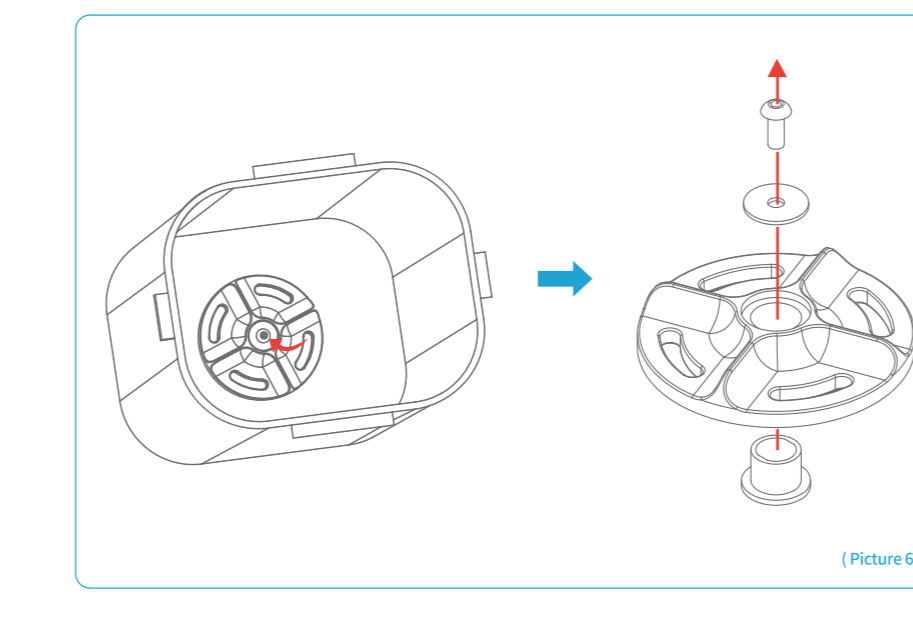

FAQ

1. The machine does not work

- The anti-UV lid is not covered. Try again after cover the lid.
- Poor power contact. Pull out the power cord and plug it in again.

2. The model turn white after washing and curing

- Insufficient alcohol concentration. Please use a concentration of alcohol greater than 95% for cleaning.
- Curing is performed immediately after the model is washed. It needs to wait for the model air dry before putting it into the machine for curing.

3. The bottom rotor of the cleaning bucket does not rotate in the washing mode.

- The rotor might be caught by foreign matters. Please try again after taking the cleaning bucket down, pouring out the washing liquid, and removing the foreign matters.
- There is too much precipitation in the washing liquid, please taking the cleaning bucket down first, and try again after cleaning the precipitation of the washing liquid or changing the washing liquid.

4. The cleaning bucket has abnormal sound during operation.

- The screw of the rotor is loose during the washing process. Please fix the screw to the rotor with tool.

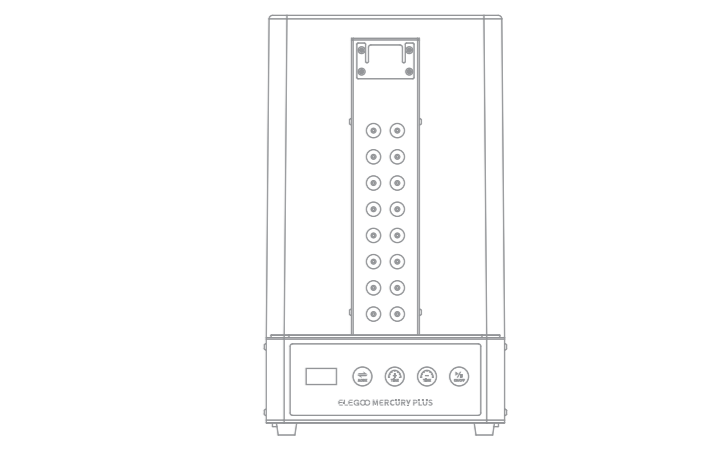

ELEGOO.COM

封底