



Owner's Manual

C-TE042/062

Tekapo

C-BE042/062

Bergen

C-OM062

Ottoman

C-ST062

Starry

EN



QUESTIONS? PROBLEMS? MISSING PARTS?
For FAQ, Manuals, Videos or Spare Parts, please visit
www.the-mspa.com/support

PLEASE DO NOT RETURN THE PRODUCT TO THE STORE

Due to MSpa's continuous product improvement process, MSpa reserves the right to change the specifications and appearance of its products, which may result in updates to the instruction manual without prior notice.

ENTER THE WORLD OF MSPA

Welcome,

Thank you for choosing MSPa and for your confidence in our brand. We believe that you will enjoy many benefits of using MSPa products for years to come.

To guide you in your initial MSPa experience, we are pleased to present you with this instruction manual. Please read this manual carefully before using the product for the first time.

We are delighted to welcome you to the MSPa family, and look forward to sharing with you the full spectrum of our expertise.

Enjoy your MSPa!



MSPA official site



MSPA Set up videos



MSPA Service Center List



MSPA Owners Manual
(Multi-language)

CONTENT

Safety precautions.....	3
Specifications.....	7
Product overview.....	7
First use and set-up preparation.....	8
Spa set-up.....	9
Controller operation.....	10
Water maintenance and chemicals.....	12
Drainage, cleaning and storage.....	13
Precautions for seasonal use.....	14
Disposal and environmental protection.....	15
Troubleshooting.....	15
MSPA limited warranty.....	17

IMPORTANT SAFETY INSTRUCTIONS

For your own safety and that of your product, make sure to follow the safety precautions below. Fail to follow the instruction may result in serious injury, property damage or death. Improper installation or operation will void the warranty.

READ AND FOLLOW ALL INSTRUCTIONS

DANGER

- DANGER:** **Risk of accidental drowning.** Extreme caution must be exercised to prevent unauthorized access by children. To avoid accidents, ensure that children can not use this spa unless they are supervised at all times.
- DANGER:** **Risk of injury.**
- a) **Replace damaged cord immediately.**
 - b) **Do not bury cord.**
 - c) **Connect to a grounded, grounding type receptacle only.**
- DANGER:** **Risk of Injury.** The suction fittings in this spa are sized to match the specific water flow created by the pump. Should the need arise to replace the suction fittings or the pump, be sure that the flow rates are compatible. Never operate spa if the suction fittings are broken or missing. Never replace a suction fitting with one rated less than the flow rate marked on the original suction fitting.
- DANGER:** **Risk of Electric Shock. Install at least 5 feet (1.5 m) from all metal surfaces. As an alternative, a spa may be installed within 5 feet of metal surfaces if each metal surface is permanently connected by a minimum 6 AWG solid copper conductor to the wire connector on the terminal box that is provided for this purpose.**
- DANGER:** **Risk of Electric Shock. Do not permit any high voltage electric appliance, such as a light, telephone, radio, or television, within 5 feet (1.5 m) of a spa.**

WARNING

- WARNING:** **The spa only for use in single-family dwellings.**
- WARNING:** **Risk of electric shock.** Insert the plug only to a properly grounded socket.
- WARNING:** The spa must be supplied by an isolating transformer or supplied through a ground-fault circuit interrupter (GFCI) having a rated residual operating current not exceeding 30mA.
- WARNING:** GFCI must be tested before each use.
- WARNING:** If the supply cord is damaged, it must be replaced immediately by the manufacturer, its service agent or similarly qualified person in order to avoid a hazard.
- WARNING:** To reduce the risk of electric shock, do not use extension cord to connect unit to electric supply; provide a properly located receptacle.
- WARNING:** No part of the appliance is to be located above the bath during use.
- WARNING:** Parts containing live parts, except parts supplied with safety extra-low voltage not exceeding 12V, must be inaccessible to a person in spa pool; Earthed appliance must be connected to the fixed receptacle which is permanently connected to fixed wiring. Parts incorporating electrical components, except remote control devices, must be located or fixed so that they cannot fall into the spa pool.

- WARNING:** The plug of spa shall be more than 3.5m away from the pool.
- WARNING:** Spray head must not be used.
- WARNING:** The outlet of Spa must not be connected to any tap or fitting other than those specified.
- WARNING:** Electric installations should fulfill the requirements of local standards.
- WARNING:** **To avoid the electric shock, do not use the spa when it is raining.**
- WARNING:** To reduce the risk of injury, do not permit children to use this product unless they are closely supervised at all times.
- WARNING:** Water attracts children. Always have the Spa locked with its cover after each use.
- WARNING:** Do not bury cord. Locate cord to minimize abuse from lawn mowers, hedge trimmers, and other equipment.
- WARNING:** Pets should be kept away from spa to avoid damage.
- WARNING:** When the bubble function is going to be in function, make sure the cover of Spa must be opened first.
- WARNING:** Do not switch on if there is any possibility that the water in the spa is frozen.
- WARNING:** Use only approved accessories. Use of non-approved accessories could void the warranty.
- WARNING:** **RISK OF ELECTRIC SHOCK.** A wire connector is provided on this unit to connect a minimum 6 AWG solid copper conductor between this unit and any metal equipment, metal enclosures of electrical equipment, metal water pipe, or conduit within 5 feet (1.5 m) of the unit.
- WARNING:** **RISK OF ELECTRIC SHOCK.** Never operate any electrical appliance when in your spa or when your body is wet. Never place any electric appliance, such as a light, telephone, radio, or television, within 1.5m of spa. During pregnancy, soaking in hot water may cause damage to the fetus. Limit use to 10 minutes at a time.
- WARNING:** Do not expose spa under direct sunshine.
- WARNING:** **This product is provided with a ground-fault circuit-interrupter in the plug. The GFCI must be tested before each use. With the product operating, open the service door. When the product stops operating, this merely indicates that the door is equipped with an electrical interlock. Next, push the test button on the GFCI and close the service door. The product should not operate. Now open the service door, push the reset button on the GFCI and close the service door. The product should now operate normally. When the product fails to operate in this manner, there is a ground current flowing indicating the possibility of an electric shock. Disconnect the power until the fault has been identified and corrected.**

TO REDUCE THE RISK OF INJURY:

- A. The water in a spa should never exceed 104°F (40°C). Water temperature between 100°F (38°C) and 104°F (40°C) are considered safe for a healthy adult. Lower water temperature is recommended for young children and when spa use exceeds 10 minutes.
- B. Since excessive water temperatures have a high potential for causing fetal damage during the early months of pregnancy, pregnant or possibly pregnant women should limit spa water temperature to 100°F (38°C).
- C. Before entering a spa, the user should measure the water temperature with an accurate thermometer since the tolerance of water temperature regulating devices varies.
- D. The use of alcohol, drugs, or medication before or during spa use may lead to unconsciousness with the possibility of drowning.
- E. Obese person and person with a history of heart disease, low or high blood pressure, circulatory system problems, or diabetes should consult a physician before use a spa.
- F. Person using medication should consult a physician before using a spa since some medication may induce drowsiness while other medication may affect heart rate, blood pressure, and circulation.

A green coloured terminal or a terminal marked G, GR, Ground, Grounding, or the  symbol* is located inside the electric box. To reduce the risk of electric shock, this terminal must be connected to the grounding means provided in the electric supply service panel with a continuous copper wire equivalent in size to the circuit conductors supplying this equipment.

* IEC Publication 417, Symbol 5019.

At least two lugs marked "BONDING LUGS" are provided on the external surface or on inside the electric box. To reduce the risk of electric shock, connect the local common bonding grid in the area of the hot tub or spa to these terminals with an insulated or bare copper conductor not smaller than No. 6 AWG.

All field—installed metal components such as rails, ladders, drains or other similar hardware within 3 m of the spa or hot tub shall be bonded to the equipment grounding bus with copper conductors not smaller than No. 6 AWG.

SAVE THIS INSTRUCTIONS

WARNING: CHILDREN SHOULD NOT USE SPAS OR HOT TUBS WITHOUT ADULT SUPERVISION.

WARNING: DO NOT USE SPAS OR HOT TUBS UNLESS ALL SUCTION GUARDS ARE INSTALLED TO PREVENT BODY AND HAIR ENTRAPMENT.

WARNING: PEOPLE USING MEDICATIONS AND/OR HAVING AN ADVERSE MEDICAL HISTORY SHOULD CONSULT A PHYSICIAN BEFORE USING A SPA OR HOT TUB.

WARNING: PEOPLE WITH INFECTIOUS DISEASES SHOULD NOT USE A SPA OR HOT TUB.

WARNING: TO AVOID INJURY EXERCISE CARE WHEN ENTERING OR EXITING THE SPA OR HOT TUB.

WARNING: DO NOT USE DRUGS OR ALCOHOL BEFORE OR DURING THE USE OF A SPA OR HOT TUB TO AVOID UNCONSCIOUSNESS AND POSSIBLE DROWNING.

WARNING: PREGNANT OR POSSIBLY PREGNANT WOMEN SHOULD CONSULT A PHYSICIAN BEFORE USING A SPA OR HOT TUB.

WARNING: WATER TEMPERATURE IN EXCESS OF 100°F(38°C) MAY BE INJURIOUS TO YOUR HEALTH.

WARNING: BEFORE ENTERING THE SPA OR HOT TUB MEASURE THE WATER TEMPERATURE WITH AN ACCURATE THERMOMETER.

WARNING: DO NOT USE A SPA OR HOT TUB IMMEDIATELY FOLLOWING STRENUOUS EXERCISE.

WARNING: PROLONGED IMMERSION IN A SPA OR HOT TUB MAY BE INJURIOUS TO YOUR HEALTH.

WARNING: DO NOT PERMIT ELECTRIC APPLIANCES (SUCH AS A LIGHT, TELEPHONE, RADIO, OR TELEVISION) WITHIN 1.5 M OF THIS SPA OR HOT TUB.

CAUTION: MAINTAIN WATER CHEMISTRY IN ACCORDANCE WITH FACTURER' S INSTRUCTION.

Hyperthermia occurs when the internal temperature of the body reaches a level several degrees above the normal body temperature of 98.6°F (37°C).

The symptoms of hyperthermia include drowsiness, lethargy, and an increase in the internal temperature of the body. The effects of hyperthermia include

- (a) unawareness of impending hazard;
- (b) failure to perceive heat;
- (c) failure to recognize the need to exit spa;
- (d) physical inability to exit spa;
- (e) fetal damage in pregnant women;

(f) unconsciousness and danger of drowning.

WARNING: THE USE OF ALCOHOL OR DRUGS CAN GREATLY INCREASE THE RISK OF FATAL HYPERTHERMIA IN HOT TUBS AND SPAS

WARNING: TO REDUCE THE RISK OF INJURY: Never pour water which higher than 104°F (40°C) into the spa pool directly.

WARNING: The use of alcohol, drugs, or medication can greatly increase the risk of fatal hyperthermia.

Hyperthermia occurs when the internal temperature of the body reaches a level several degrees above the normal body temperature of 98.6°F (37°C). The symptoms of hyperthermia include an increase in the internal temperature of the body, dizziness, lethargy, drowsi-ness, and fainting, The effects of hyperthermia include failure to perceive heat; failure to recognize the need to exit spa; unawareness of impending hazard; fetal damage in pregnant women; physical inability to exit the spa; and unconsciousness resulting in the danger of drowning.

WARNING: Warning Label Instruction

Please carefully read the warning label at the first time you are going to use MSpa.

Please post this warning label on where is at a distance to MSpa within 1.5m/5', people in spa can see it clearly.

Please retain this information for future reference.

If the warning label is damaged or missing, please contact your country MSpa service center to get a new one.

⚠ CAUTION

CONSULT YOUR PHYSICIAN FOR RECOMMENDATIONS.

CAUTION: The spa should not be setup or left out in temperature lower than 39°F (4°C).

CAUTION: Do not use the spa alone.

CAUTION: People with infectious diseases should not use a spa.

CAUTION: Do not use the spa immediately following strenuous exercise.

CAUTION: Always enter and exit the spa slowly and cautiously. Wet surfaces are slippery.

CAUTION: To avoid damage to the pump, the spa must never be operated unless the spa is filled with water.

CAUTION: Immediately leave spa if uncomfortable or sleepy.

CAUTION: Never add water to chemicals. Always add chemicals to water to avoid strong fumes or violent reactions that may result in hazardous chemical spray.

CAUTION: Place only on surface that can withstand the floor loading requirement of your Spa.

NOTE: Please examine equipment before use. Notify after service center listed on this manual for any damaged or missing parts at the time of purchase. Verify that the equipment components represent the models that you had intended to purchase.

SPECIFICATIONS

BUBBLE SPA								
Model No. / Code	Shape	Seating Capacity	Water Capacity	Outside Dimensions	Inside Dimensions	Height	Weight	Temp Increasing Rate
C-TE042 Tekapo	Square	4	650 L (171 Gal.)	1.58 x 1.58 m (62" x 62")	1.18 x 1.18 m (46.5" x 46.5")	0.68m (27")	22.5 kg (49.6 lbs)	2.5-3.5°F/h
C-TE062 Tekapo	Square	6	930 L (245 Gal.)	1.85 x 1.85 m (73" x 73")	1.45 x 1.45 m (57" x 57")	0.68m (27")	25 kg (56.1 lbs)	2.0-3.0°F/h
C-BE042 Bergen	Round	4	700 L (184 Gal.)	Ø1.80 m (71")	Ø1.4 m (55")	0.70m (28")	23 kg (50.7 lbs)	2.5-3.5°F/h
C-BE062 Bergen	Round	6	930 L (245 Gal.)	Ø2.04 m (80")	Ø1.6 m (63")	0.70m (28")	26 kg (57.3 lbs)	2.0-3.0°F/h
C-OM062 Ottoman	Round	6	930 L (245 Gal.)	Ø2.04 m (80")	Ø1.6 m (63")	0.70m (28")	26 kg (57.3 lbs)	2.0-3.0°F/h
C-ST062 Starry	Round	6	930 L (245 Gal.)	Ø2.04 m (80")	Ø1.6 m (63")	0.70m (28")	26.5 kg (58.4 lbs)	2.0-3.0°F/h

Control System Specs	C-TE042 / C-TE062 / C-BE042 / C-BE062 / C-OM062 / C-ST062
Control System	AC 110-120V~ 60Hz, 12A
Heater	675W x 2
Massage Air Blower	700W
Filter Pump	1800L/hr
UVC Radiant flux	2000uW
Top Lid	Rhino-Tech™ reinforced PVC
Liner Material	PVC + Premium Rhino-Tech™ reinforced PVC

PRODUCT OVERVIEW

Packaging content

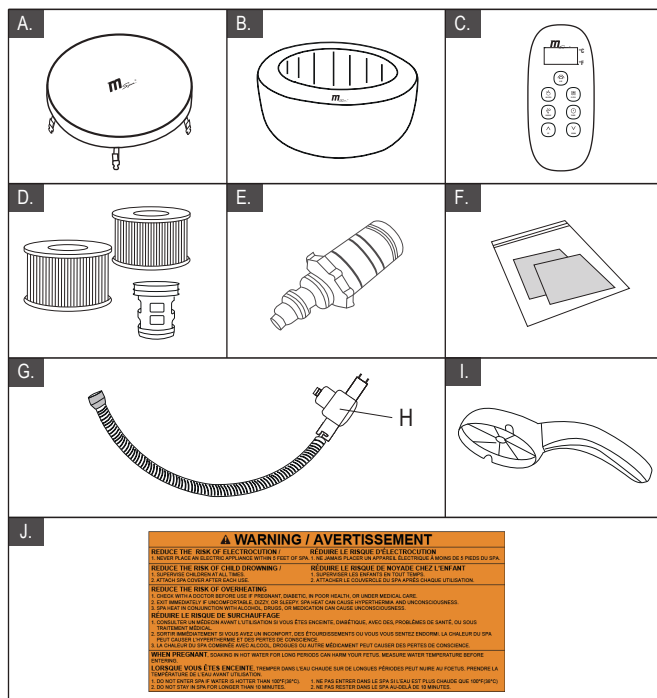

REF. NO.	PARTS DESCRIPTION
A	Buckle spa cover
B	Spa tub
C	Wired controller
D	Filter cartridge * 2, cartridge base * 1
E	Garden hose adaptor
F	Repair kit
G	Inflation hose
H	Manometer
I	Wrench
J	Warning label

NOTE: The drawings are for reference only. Actual products may vary. Not to scale.
 Use accessories exclusively provided by MSPA for safety reasons.
 When ordering parts, be sure to quote the SPA model number and description.

FIRST USE AND SETUP PREPARATION

Site preparation and requirements

- The spa can be installed indoors or outdoors in around 10 minutes by one or more persons. For household use only.
- The spa must be set up on a flat, smooth and supporting surface that is able to bear the maximum load of the filled spa with the listed maximum number of occupants. Check with a qualified contractor or structural engineer to verify the requirement.
- Make sure the area is free of sharp objects under or around the spa. Uneven or unsound surface can damage the spa and void your warranty. Level the surface before filling the spa with water.
- Provide an adequate drainage system around the spa to deal with overflow water and splashes. Provide a convenient water supply for filling the spa that complies with any local water regulations, and whose parameters shall be adjusted with the requirements of the water treatment section.
- Make sure there is enough clearance around the spa for full access to the equipment for maintenance and/or servicing.
- Consider positioning the spa to minimize noise disturbance as much as possible.

Additional requirements for indoor installation

- Humidity is a natural side effect of indoor spa installation. The room must be properly ventilated to allow moisture to escape. Install a ventilating system to prevent excess condensation moisture in the room.
- Ensure the spa can be removed from the building without destroying any part of the built structure.
- Consider any local regulations on these topics.
- Consider not to install the spa on carpet or other floor materials that promote or harbor moisture and bacterial, or that could be affected by water treatment chemicals used in the spa.

Additional requirements for outdoor installation

- Do not set up the spa on grass or dirt, as this will increase the amount of debris entering the spa and will damage the floor.
- To ensure a longer lifespan, do not leave the spa tub exposed to direct sunlight.
- Always keep the manometer within the yellow section when using the spa at a temperature higher than 20°C (68°F) or when exposing it to sunlight for a short time.
- Do not install or use the spa outdoors at a temperature lower than 4°C (39°F). Do not use the spa when the water inside the circulation system, pump, or pipework is frozen. Put a heat preservation mat (optional accessories) between the base of the spa and the ground to prevent heat loss from the bottom of the spa and to provide better heat retention.
- Consider local environmental conditions, such as ground water and risk of frost.

GFCI Testing

⚠ WARNING

Risk of electric shock: This product is provided with a GFCI located at the end of the power cord. The GFCI plug must be tested before each use. Do not use the spa if the GFCI plug does not function properly. Disconnect the power cord until the fault has been identified and corrected. Contact a licensed electrician to correct the fault. There are no serviceable parts inside the GFCI plug. Opening the GFCI plug will void the warranty.

1. Plug the machine into the mains.
2. The GFCI plug might automatically reset. If the **RESET** indicator is not red, press the **RESET** button.
3. Press the **TEST** button on the GFCI. The GFCI indicator should shut off. If the GFCI indicator does not turn off, the GFCI is faulty. Do not use the spa. Contact a qualified electrician to correct the fault.
4. Press the **RESET** button on the GFCI again. The indicator should turn red. If yes, the spa is ready for use.

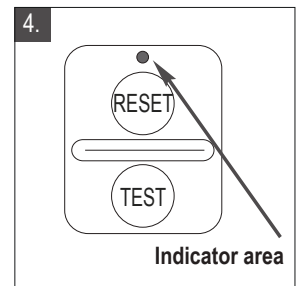
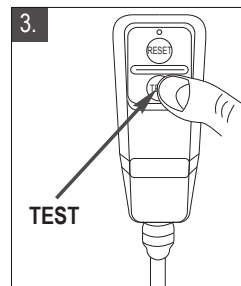
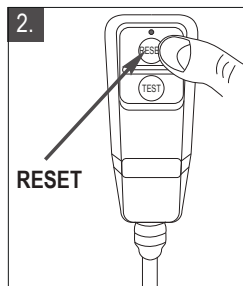
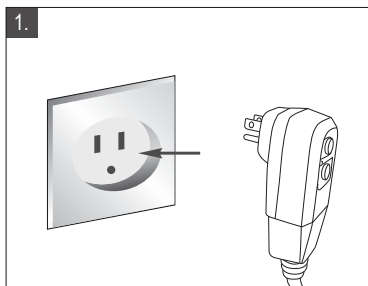

Spa Control Unit Connected External Equipotential Bonding Conductors

A qualified electrician should wire the spa control unit to the household equipotential terminal using a minimum 1.5mm² solid copper conductor.

SPA SET-UP

1

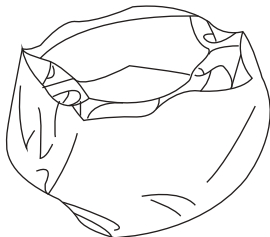

2

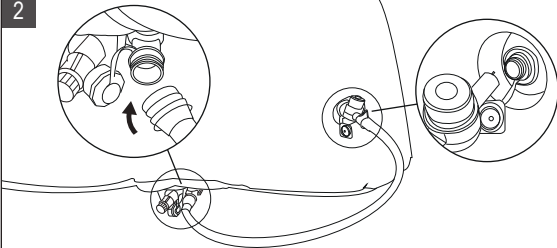

Make sure the inflation hose is properly installed as pictured above.

3

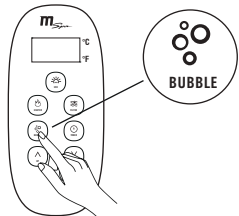

Press the BUBBLE button for inflation.

4

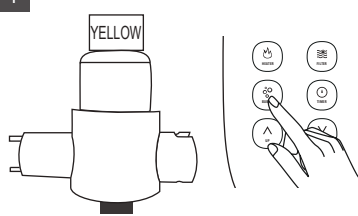

Press it again to stop inflation when the manometer points to the **YELLOW** section.

5

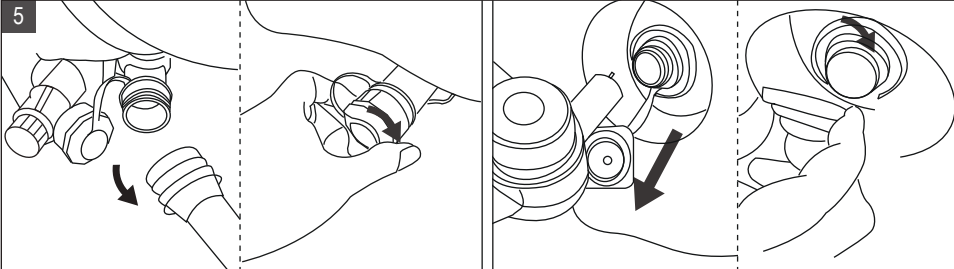

Disconnect the inflation. Rotate the air valve cap back.

NOTE: Your spa will require additional air to be added from time to time. Changes in temperature from day to night will change the pressure in the spa and may cause a certain amount of deflation.

IMPORTANT: ALWAYS READ THE MANOMETER TO ENSURE THAT THE SPA IS FILLED AT THE CORRECT AIR PRESSURE FOR THE CONDITIONS.

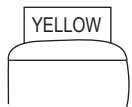

Ensure the manometer points to the **Yellow** section in the following conditions

- After inflation, before filling the water.
- When leaving the spa outdoors unattended for long periods of time at a temperature higher than 20°C (68°F).



Ensure the manometer points to the **Green** section in the following conditions

- When the spa is filled with water.
- When the spa is in use.

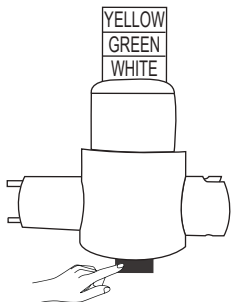

WARNING: If the manometer points to the **White** section, the air pressure of your spa is too high.

Press the black button on the bottom of manometer to release some air until the pointer returns to the **Green** or **Yellow** section.

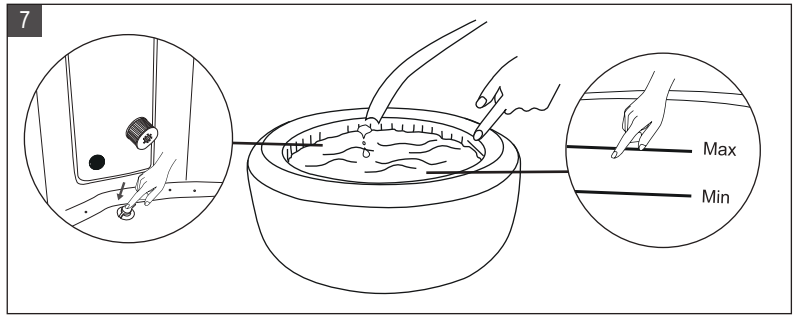
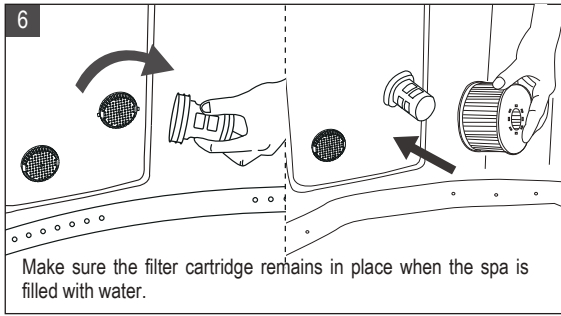

NOTE: It is recommended to fill the spa with lukewarm water for quick heating and energy saving. Using tap water for spa filling to minimize the influence of unwanted content, such as minerals.

NOTE: Ensure the manometer points to the Green section when the spa is filled with water.

WARNING:

Do not drag the spa after filling it with water.

Do not operate the spa until the water reaches the Minimum line.

The water temperature should not be higher than 40°C / 104°F.

Buckle Lock Operation

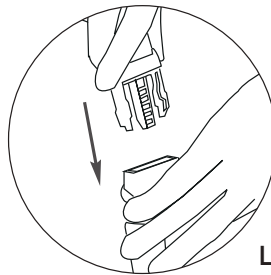
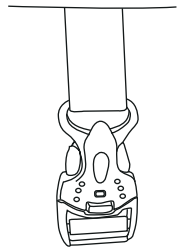
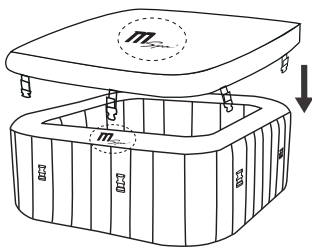

Lock

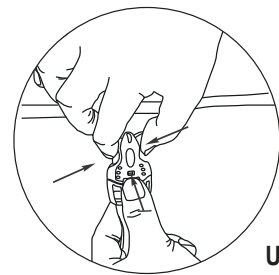

Unlock

NOTE: Always keep the spa cover on to minimize heat loss when heating the water.

Make sure the cover, and mostly its side facing water, will not come into contact with the ground or any other dirt when not in use.

Covers shall be cleaned inside and out periodically using a suitable solution that includes adequate disinfection (e.g. 10mL/L of free Chlorine).

CONTROLLER OPERATION

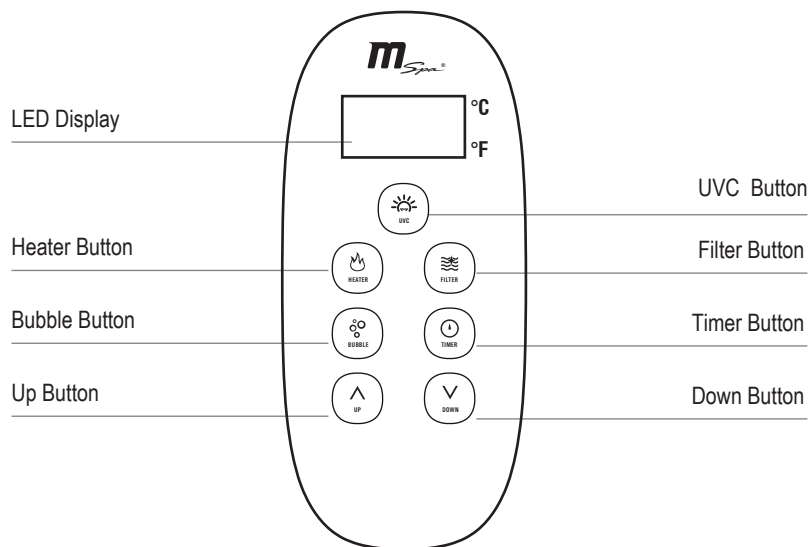



LED display

Once powered-up, press the **RESET** on the GFCI. The LED displays the current water temperature automatically.

NOTE: The actual water temperature may vary from the temperature displayed on the LED screen by as much as approximately 1°C (33.8°F).



UVC SANITIZER

Press the  UVC button to turn the UVC sanitizing system on/off. When the light above this button is green, the UVC sanitizing system is activated.

NOTE: The UVC emitter is built inside the control box. Therefore, the function can be turned on at any time, even with people inside the spa.





HEATING

20-40°C

1. Press the  **HEATER** button to turn the heating system on/off. When the light above the heat button is red, the heating system is activated.

When the light is green, the water is at the set temperature and the heating system is at rest.

2. Pressing the  **UP** or  **DOWN** button will cause the LED to flash. When it is flashing you can adjust the water to the desired temperature setting (from 20°C (68°F) to 40°C (104°F)). The new and desired temperature setting will remain on the LED display for 3 seconds to confirm the new value.

NOTE: The default temperature is 40°C (104°F).

NOTE: If the heating system is turned on, the filtration system will automatically start.

NOTE: When the water temperature is below 1°C (33.8°F), the anti-icing system will be activated automatically to heat the water to 3°C (37.4°F).

IMPORTANT: The following conditions will lead to slow water heating

- An ambient temperature lower than 10°C (50°F).
- An outdoor wind speed above 3.5-5.4m/s (8-12mph).
- If the air bubble function is activated when the heater is on.
- If the spa cover is not properly in place when the heater is on.



FILTRATION

Press the  **FILTER** button to turn the function on/off. The light turns to green when the function is activated.

NOTE: The filtration system will automatically start when the heating or UVC sanitizing system is activated.

NOTE: After turning off the heating system, the filtration system will automatically stop in 30 seconds.

Filter Cartridge Cleaning Reminder: When the FILTER button is flashing or displays red, the filter cartridge must be cleaned or replaced. Once this has been done, press the Filter button for 3 seconds to reset the reminder.

Auto-filtration: When the spa is in stand-by mode, the filtration system will operate automatically for 60 minutes every 8 hours.



BUBBLE MASSAGE

Press the  **BUBBLE** button to turn the massage system on/off. The Bubble button displays green when activated.

IMPORTANT: Do not turn on the massage system when the cover is attached. Air can accumulate inside the spa and cause irreparable damage and bodily harm.



NOTE: The bubbling massage function will shut down automatically after every 20 minutes of operation as a safety precaution. This can be reactivated after 10 minutes by pressing the BUBBLE button again.



HEATING TIMER

1-99H

To set the number of hours **FROM NOW** when the heater will activate:

1. Press the  **TIMER** button to enter pre-setting mode. The button displays green.
2. Pressing the  **UP** or  **DOWN** button will cause the LED to flash. While it is flashing, you can adjust the number of hours before heater activation (from 1 to 99 hours). The desired timer setting will remain on the LED display for 3 seconds to confirm the value.



To modify the timer setting: Press the **Timer** button again and use the **UP** or the **DOWN** button to adjust.

Cancel the setting: Press the **TIMER** button for 3 seconds.

NOTE: Activating the heating system or rebooting the spa will cancel the timer setting.



SAFETY LOCK

Press the  **UP** and  **DOWN** buttons at the same time for 3 seconds to lock/unlock the controller. In safety lock mode, the controller is disabled and the spa retains all previous settings.



Celsius/Fahrenheit Toggle Button

The temperature can be displayed in either Celsius or Fahrenheit. Long press  **DOWN** button for 3 seconds to switch.

3s

WATER MAINTENANCE AND CHEMICALS

CAUTION: ALWAYS ENSURE THE SPA IS UNPLUGGED BEFORE BEGINNING ANY MAINTENANCE WORK TO AVOID THE RISK OF INJURY OR DEATH.

FILTER CARTRIDGE MAINTENANCE

1. Inspect and clean the filter cartridge gently after each use. Follow the steps below:

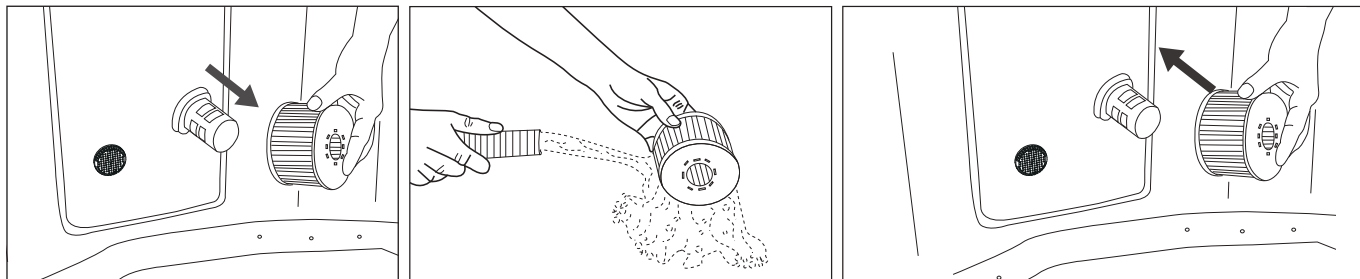

NOTE: Change the filter cartridge every 3-5 days, or if the filter cartridge remains soiled and discolored.

NOTE: When the spa is filled with water, there should always be a filter cartridge installed on the base.

NOTE: Turn off all the functions before changing or cleaning the filter cartridge.

2. If the spa's inlet or outlet becomes clogged with dirt, use the wrench to unscrew the cap and then clean as necessary.

NOTE: Before unscrewing the part, make sure the spa is empty. Never unscrew it when the spa is filled with water!

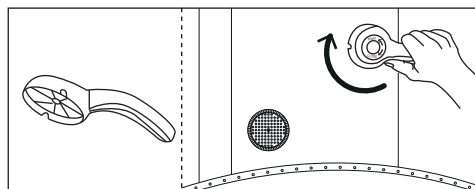

SPA WATER

1. Change the spa water every 3-5 days depending on use. If dirt is visible in the water or if the water becomes cloudy and the correct water chemistry does not clear it up, change the water and clean the spa tub. See the "Cleaning, draining and storage" section for instructions.
2. We recommend taking a shower before using the spa, as cosmetic products, lotions and other residues on the skin can quickly degrade the water quality.
3. When the spa is not in use, cover it with the buckle cover to prevent pollution.
4. Use spa chemicals to maintain the proper water conditions. Spa damage resulting from the misuse of chemicals or the mismanagement of spa water is not covered by the warranty. Consult with your local spa or pool retailer for more information on chemical use.

Water Sanitation

The spa owner must regularly check and keep the spa water sanitized with scheduled maintenance (daily, if necessary). Adding sanitizer or other chemicals will control bacteria and the reproduction of viruses in the spa water. Maintaining the correct water balance through the appropriate use of sanitizers is the most important factor in maximizing the life and appearance of the spa and ensuring clean, healthy and safe water.

Adopting the proper technique is important for testing and treating the spa water. Contact your spa professional if you have any questions on chemicals, sanitizers, test kits or test procedures.

Water Balance

Follow the instructions below to maintain your spa water.

PARAMETER	TEST FREQUENCY	CORRECT LEVEL
pH	Daily	7.2-7.6 when using Chlorine; 7.2-7.8 when using Bromine
Free Chlorine	Daily	3-5 ppm
Bromine residual	Daily	2-4 ppm
Total Alkalinity (TA)	Weekly	80-120 ppm
Total Hardness (TH)	Weekly	200-500 ppm

NOTE

- A low pH will damage the spa tub and pump. Any damage resulting from a chemical imbalance will void the warranty.
- A high pH (hard water) will result in white coagulations inside the filter pump, which may lead to pump damage.

Water Treatment:

- It is good practice with an existing spa to keep all air jets open and valves closed to allow chemically treated water to flush through all pipework.
- Always follow the chemical manufacturer's directions, and the health and hazard warning.
- Bromine are highly recommended for TEKAPO / BERGEN.
- Never mix chemicals together. Add the chemicals to the spa water separately. Thoroughly dissolve each chemical before adding it to the water.
- Please note that chlorine and bromine products should never be mixed. This is extremely dangerous. If you usually use chlorine-based products and you want to switch to bromine-based products, or vice versa, it is essential that you change the spa water first.
- Do not add chemicals if the spa is occupied. This can cause skin or eye irritation.
- Do not overuse chemicals or use concentrated chlorine. This can damage the spa tub and cause potential hazard to your skin. Improper chemical use will void the warranty.

DRAINAGE, CLEANING AND STORAGE

Spa Drainage

- 1 Turn off all the functions

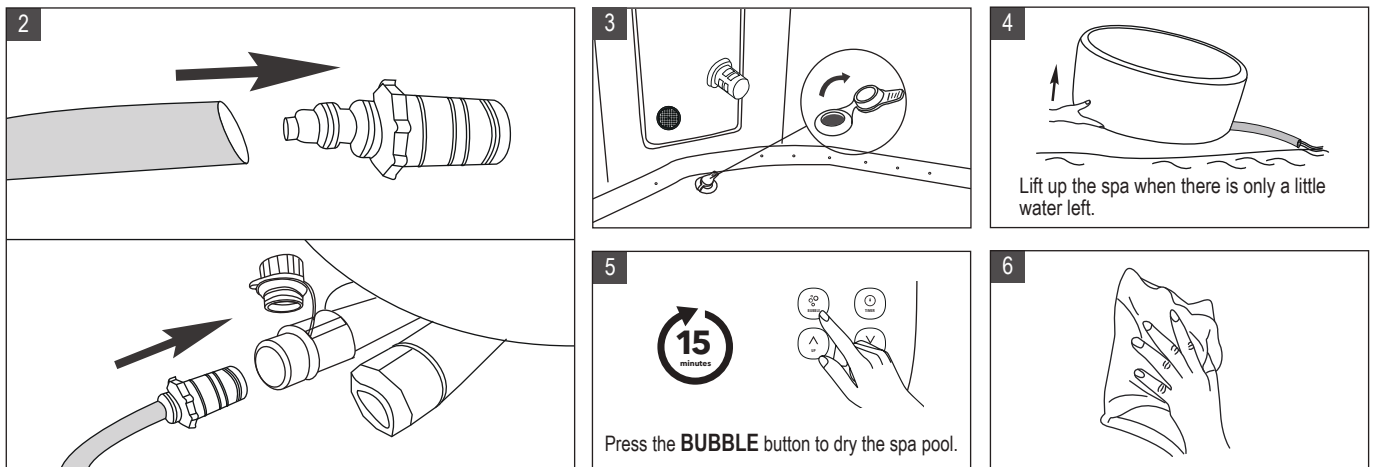

Spa Tub Cleaning

After the spa water is drained, use a sponge and a mild soap solution to wipe away any soil or stains on the inside of the spa wall. Rinse thoroughly before refilling with clean water.

IMPORTANT: Do not use steel wool, hard brushes or abrasive cleaners.

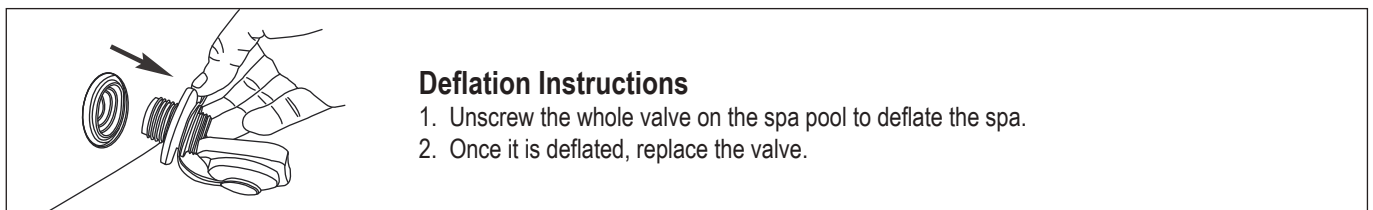

Spa Tub and Air Bladder (*Optional) Repair

Use the enclosed repair patch to repair any puncture:

1. Clean and dry the area to be repaired thoroughly
2. Apply the glue to the PVC patch and quickly attach it onto the damaged surface. (Glue is not included)
3. Smooth the surface to remove any air bubbles and allow it dry for 5-10 minutes

NOTE: Glue is not included.

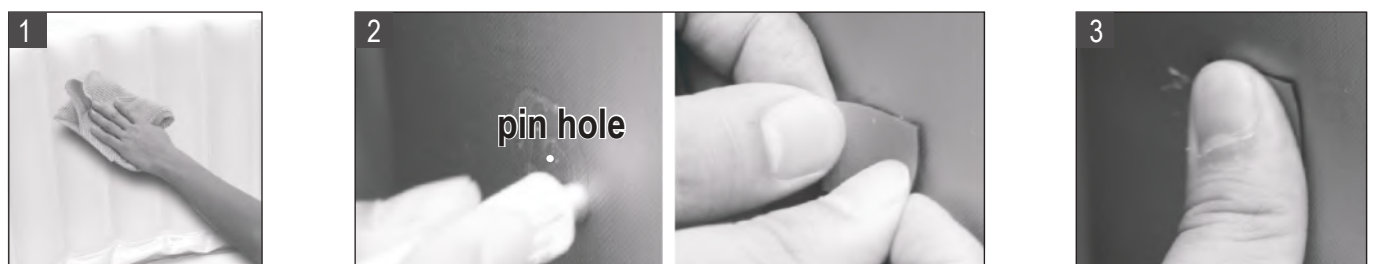

Storage and Preparation for Future Use

1. Drain and clean the spa by following the "Drainage" and "Spa Cleaning" sections.
2. Refer to the instructions to deflate and disassemble the spa tub, spa control unit and air bladder (*optional).
3. Make sure all the spa components and accessories are thoroughly clean and dry before storage. Air-dry the spa tub in mild sunlight for an hour before folding.
4. Fold the spa tub loosely and avoid any sharp corners to prevent damage or leakage to the spa liner.
5. Prepare a new additional cartridge for next time use.
6. Store the spa and accessories in a dry, temperature-controlled storage area (between 0°C and 40°C (32°F - 104°F)).
7. The original packaging is recommended for storage.

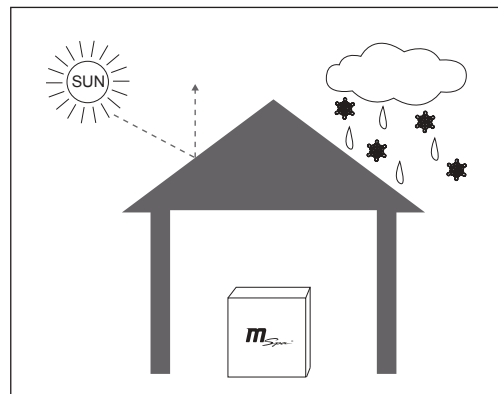

PRECAUTIONS FOR SEASONAL USE

Inflatable hot tubs are made of reinforced PVC material, whose nature decides the hot tubs are easily affected by weather and temperature. Please do pay special attention when using the spa under different seasonal conditions.

In Summer / Sunny days

Direct sunshine and hot weather will both lead the spa liner to expand.

- To extend the service life of the spa, it is suggested to place the spa in a sheltered place.
- Please check the air pressure regularly. The manometer should always point to the Green section when spa is filled with water. When leaving the spa outdoors unattended for long periods of time, release some air until the manometer points to the Yellow section. This will prevent the spa liner from expanding too much due to rising temperature during the daytime.
- To protect your skin from sunburn, it is highly recommended to enjoy the spa in the morning or evening when the sunlight is milder and temperature is more comforting.
- Check the water temperature and consider lowering it for the times when the spa is not in use. Turn off the heater entirely if not using the spa for an extended period of time.

In Winter

Inflation

Low temperature will harden the PVC material and make it more fragile.

- The new spa might have been stored or transported at a low temperature (below 4°C / 39°F) before it is unfolded. Put the package indoors or somewhere warm for 12 hours to soften the material before use.
- The lower the temperature is, the more air the spa tub will require, and the longer the inflation will take. After water is heated to a much higher temperature, the air inside the chamber will get swollen. To shorten the inflation period, and to reduce the expansion of the spa liner, we suggest inflating the spa at a temperature higher than 15°C / 59°F. If the ambient temperature is below 0°C / 32°F, the spa should not be inflated.

Heating and Heat Preservation

In cold weather, heating the water up will take much more time. It is suggested to:

- Fill the spa tub with lukewarm water (not higher than 40°C / 104°F) to get it heated it more quickly.
- Use ground mat and inflatable bladder for better heat preservation effect.
- When the outdoor temperature is below 4°C(39°F), even when not using the spa, as long as it is filled with water, the heater should always be turned on (or put the spa in stand-by mode) to prevent water from freezing.
- Your spa is equipped with an Anti-icing System. Put the spa in stand-by mode, when the water temperature falls below 1°C/33.8°F, the heater runs automatically until the water is heated up to 3°C/37.4°F. This will help prevent water from freezing. If you are not going to use the spa in near future, please disassemble the spa and store it following the storage procedure.

In Rainy days

MSpa has an IPX5 water-resistant rating, meaning it can resist a sustained, low-pressure water spray. Therefore, the spa can be placed outdoors in light rain.

However, if you still insist on using the spa without any rainproof facilities above, do not turn on the bubble function. This is because the rain in the air is also sucked into the pump, causing the bubble generator to get damp and rusty which could result in malfunction and void your warranty.

Although the plug also has an IPX5 rating, it is recommended to put it somewhere not exposed to rain to prevent damage caused by water accumulation due to excessive rain.

DISPOSAL AND ENVIRONMENTAL PROTECTION



This marking indicates that the product should not be disposed of with other household waste. To prevent possible harm to the environment or human health from uncontrolled waste disposal, recycle the product responsibly to promote the sustainable reuse of material resources. Information on disposal can be obtained from your local authorities.

To return your used device, please use the return and collection systems or contact the retailer where the product was purchased for environmentally safe recycling.

TROUBLESHOOTING

ERROR CODE CHART

LED READING	CAUSE	SOLUTION
--- / 888 / EEP	Signal wire is loose	Contact local MSpa Service Center
	Communication failed	Contact local MSpa Service Center
F0	Water temperature is below 0°C (32°F) or exceeds 50°C (122°F)	Change the water
	Temperature sensor failure	Contact local MSpa Service Center
F1	F1 immediately shows after pressing FILTER, HEATING or UV	Clean the parts and tubes that the water goes through
	F1 shows 15s after pressing FILTER, HEATING or UV	1. Add more water to the minimum line 2. Clean the parts and tubes that water goes through 3. Contact local MSpa Service Center

PROBLEM	CAUSE	SOLUTION
NO DISPLAY ON THE CONTROL PANEL	Power socket failure	Change a socket or repair the socket before use
	GFCI is off	Reset the GFCI by following the GFCI Testing section
	Press the Reset button, controller is not displayed	Contact local MSpa Service Center
	GFCI broken	Contact local MSpa Service Center
SPA LEAKING	Spa in&outlet connection not securely tight	Tighten the in&outlet connection
	Drainage valve is not closed completely	Close the drainage valve. Contact the MSpa Service Center, if spa is still leaking
	Water leaks from the spa pool body	Repair the leaking hole/split with the repair kit material
NOT HEATING PROPERLY	Temperature set too low	Set a higher temperature
	Dirty filter cartridge	Clean or replace the filter cartridge
	Water level is not at the minimum water line	Add more water to the minimum line
	Heater failure	Contact local MSpa Service Center
	Filter pump DOES NOT WORK	Refer to the "FILTER PUMP DOES NOT WORK" section
SPA LOSES AIR	Air valve is loose	Inflate the spa till Yellow section of the manometer is pushed out. Make sure the valve is screwed tightly. Replace the valve if necessary.
	Hole or split on the spa tub	Fill a squirt bottle with soapy water and spray on the seams. If there is a leak, small bubbles will come out. When you have located the leak, clean and dry the leaking area, then use the repair patch supplied with your spa. Check the repair section on P15.
WATER NOT CLEAN	Water has been used for long period of time	Change the water
	Insufficient filtering time	Extend the filtration time
	Dirty filter cartridge	Clean or replace the filter cartridge in time
	Improper water maintenance	Refer to the chemical manufacturer's instructions

PROBLEM	CAUSE	SOLUTION
SPA TUB IN AN ABNORMAL SHAPE	Extra air pressure due to strong sunlight	Check the air pressure and release air if necessary During hot weather, it is advisable to check whether some air should be released to avoid any possible damage to the spa pool.
NO BUBBLE	Auto-off 10 minutes	Wait for 10 minutes and turn on the Bubble button again
	Internal parts damaged	Contact local MSpa Service Center
	One-way valve broken	Contact local MSpa Service Center
FILTER PUMP DOES NOT WORK	Filter cartridge clogged by dirt or other objects	Clean or replace the filter cartridge
	Filter system failure	Contact local MSpa Service Center

Where can I find the serial number?

At the back of controller. Or at the foot of the control box.

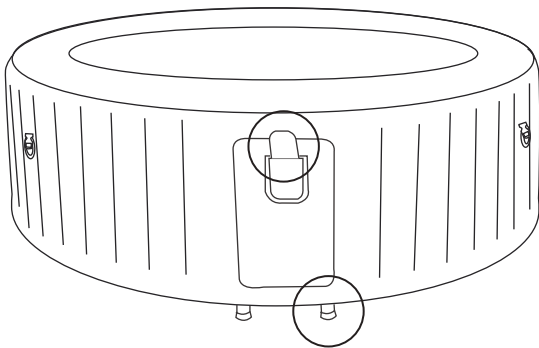

How can I find my service contact?

Scan the QR code below or visit <https://www.the-mspa.com/after-sales>.

1. Input the serial number of your spa.
2. The corresponding service provider will be displayed.



CONTACT YOUR LOCAL MSPA DEALER OR SERVICE CENTER FOR ANY PRODUCT-RELATED QUESTIONS OR PROBLEMS.

MSPA LIMITED WARRANTY

MSpa® has been manufactured with reliability and simplicity in mind. All products have been inspected and found free of defects prior to leaving the factory.

MSpa warrants this product against defects in material and workmanship for a period of:

TWELVE (12) months - Electric Parts (Control Box)

SIX (6) months - Spa pool.

The warranty period begins on the date of purchase and MSpa requires presentation of the original proof of purchase to ascertain the date. During the warranty period, MSpa will either repair or replace, at its discretion, any defective products. Replacement products or repaired parts will be warranted for only the unexpired portion of the original warranty.

Shipping Policy

Consumers are responsible for the shipping/freight when return the defect parts to MSpa authorized service center or ORPC-Oriental Recreational Products (Shanghai) Co., Ltd.

Warranty Policy

- This limited warranty does not apply to any defect resulting from negligence, accident, misuse, or any other reason beyond MSpa's reasonable control, included but not limited to: normal wear and tear, negligence or failure to follow the product instructions, improper or inadequate maintenance; connection to an improper power supply; chemical water damage, loss of pool water, unauthorized product modification or repair; use for commercial purposes; fire, lightning, flood or other external causes.
- This warranty is valid only in the country of purchase in such countries where MSpa sells and services the same model with identical technical specifications. Warranty service outside the country of purchase is limited to the terms and conditions of the corresponding warranty in the country of service. Where the cost of repairs or replacement is not covered by this warranty, MSpa will advise the owners and the cost shall be charged to the owner.
- This warranty only applies to the original purchaser and terminates upon any transfer of ownership.
- All repairs for which warranty claims are made must be pre-authorized by ORPC through an accredited distributor or agent provided that the defective part be returned to the distributor or agent Transportation Prepaid, if requested.
- The authorized selling dealer is responsible for all in-field service work carried out on your MSpa product. ORPC will not be liable for the cost of any workmanship carried out by an unauthorized service person.
- Products marked with both MSpa and importer are governed exclusively by the warranty provided by the importer.

Warranty Registration

Please Always keep the purchase receipt and warranty card in case of a future warranty inquiry. All claims must be submitted to an MSpa authorized dealer or service partner. It is essential that all submitted claims provide all the necessary information, including Customer name, Purchase receipt, Serial No., Product No., Problem, and Parts requested.

Annex A

Ensure that you read carefully, understand and follow all of the information in this user manual before installing and using your spa. These warnings, instructions, and safety guidelines address some common risks associated with water recreation, but they cannot cover all risks and dangers in all cases. Always use caution, common sense, and good judgment when enjoying any water activity. Retain this information for future use. In addition, the following information can be supplied depending on the spa type:

Safety of non-swimmers

- Continuous, active, and vigilant supervision of weak swimmers and non-swimmers, especially in exercise spas, by a competent adult is required at all times (remembering that children under eight years of age are at the highest risk of drowning).
- Designate a competent adult to supervise the spa each time it is being used.
- Weak swimmers or non-swimmers should wear personal protection equipment, especially when using the exercise spa.
- When the spa is not in use, or unsupervised, remove all toys from the spa and its surrounding area to avoid attracting children to the spa.

Safety devices

- A safety cover or other safety protection device must be used, or all doors and windows (where applicable) shall be secured to prevent unauthorized access to the spa.
- Barriers, covers, alarms, or similar safety devices are helpful aids, but they are not substitutes for continuous and competent adult supervision.

Safety equipment

- It is recommended to keep rescue equipment (e.g. a ring buoy) by the spa (if appropriate).
- Keep a working phone and a list of emergency phone numbers near the spa.

Safe use of the spa

- Encourage all users, especially children, to learn how to swim.
- Learn Basic Life Support (Cardiopulmonary Resuscitation — CPR) and refresh this knowledge regularly. This can make a life-saving difference in the event of an emergency.
- Instruct all spa users, including children, on what to do in case of an emergency.
- Never dive into any shallow body of water. This can lead to serious injury or death.
- Do not use the spa when using alcohol or medication that may impair the bather's ability to safely use the spa.
- When covers are used, remove them completely from the water surface before entering the spa.
- Protect spa occupants from water-related illnesses by advising them to keep the water treated and practice good hygiene. Consult the water treatment guidelines in the user's manual.
- Store chemicals out of the reach of children.
- Use the signage provided on the spa or within 2000 mm of the spa in a prominent visible position.