

# Smart Plug Gen2

## User Manual

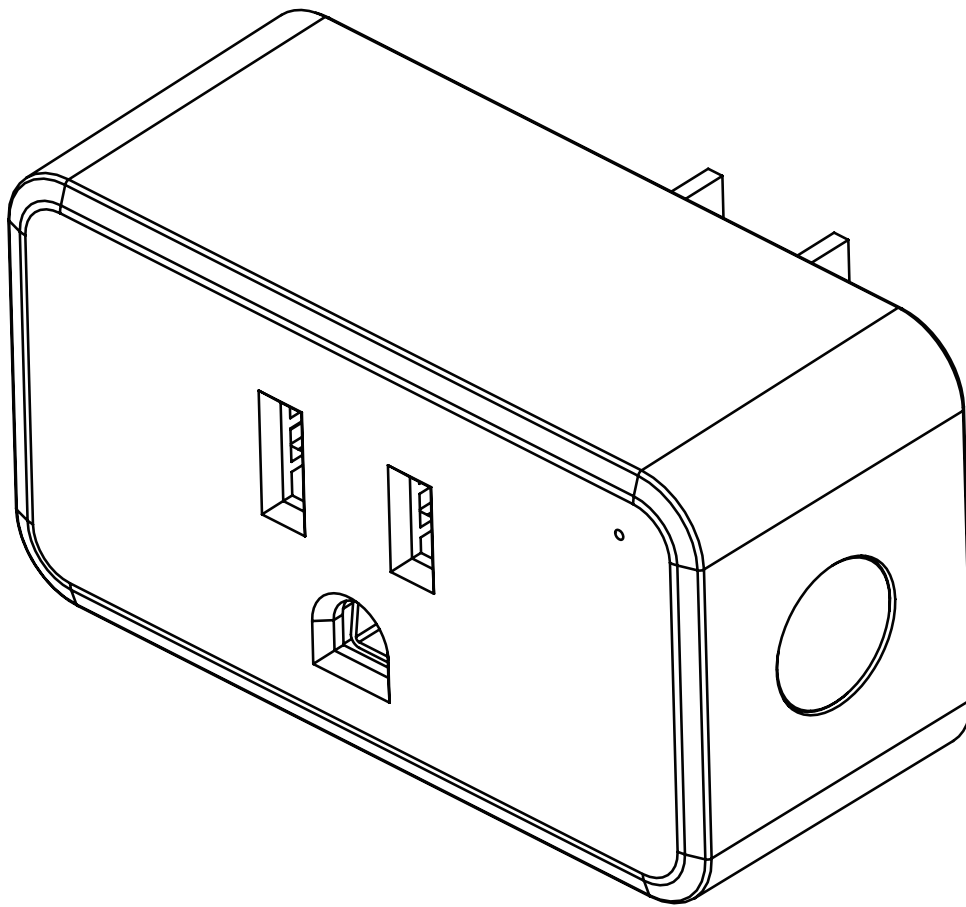

THIRD REALITY

# Specifications

Model Number	3RSP03028BZ
Electrical Characteristics	100~120V AC,15A max,50/60Hz
Working Temperature	-10°C~40°C
Operating Humidity	5%~90% RH(Non-condensing)
Connectivity	Zigbee 3.0
App Support	IOS/Android

## Features

1. Real-time Energy Monitoring: Monitor current consumption of your plug-in devices, effectively save energy and reduce waste. This function supported by Home Assistant, SmartThings, Hubitat and THIRDRREALITY smart hub Gen2.
2. Compatible with Zigbee devices from Amazon Echo/ SmartThings/Home Assistant/Hubitat/Third Reality etc.
3. Act as a Zigbee repeater, increasing the range of your Zigbee mesh network.
4. Customize On/Off state when power is restored.

# Setting up your Smart Plug Gen2

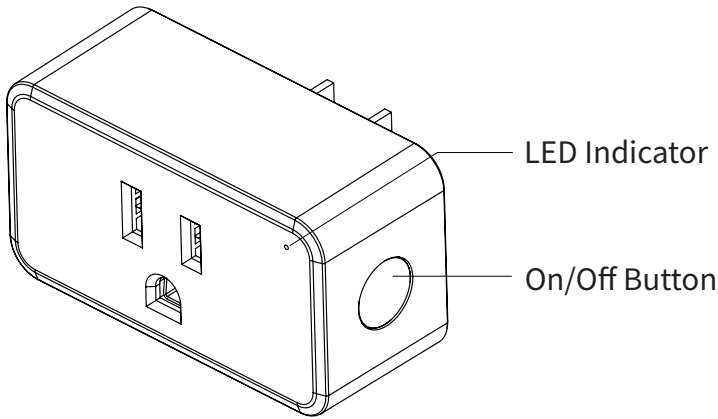

## LED Status

Pairing: LED light flashes in red.

Pairing Completed: LED light is out.

Power ON: LED light is ON in red.

Power OFF: LED light is OFF.

Bluetooth Pairing: LED light flashes in green and red.

## Factory Reset

After your Smart Plug is powered on, press and hold the On/Off button for more than 10 seconds until the LED light flashes in red indicating that your Smart Plug is in pairing mode.

## Pairing with compatible Echo Speakers or other Zigbee devices

Compatible devices: Echo 4th Gen, Echo Plus 1st Gen/2nd Gen, Echo Show 10 2nd Gen, Echo Show 10 3rd Gen, Echo Studio. Eero 6, Eero 6 Pro, SmartThings 2015/2018, Hubitat Elevation, Home Assistant (ZHA/Zigbee2MQTT), Third Reality Hub.

1. Update your hub firmware and phone app to the latest version before pairing, set up your Zigbee Hub by following its user manual.
2. Insert the Smart Plug into an outlet, it will enter pairing mode automatically.
3. Follow the instructions in the corresponding phone app to complete the setup. For compatible Echo Devices, you can also say "Alexa, discover devices", then Echo will find it automatically.

## **Upgrade the firmware of the smart plug over Bluetooth in Third Reality app**

1. Download and install Third Reality app on your phone, create an account and login, turn on the Bluetooth on your phone.
2. Switch the smart plug Gen1/Gen2 from Zigbee mode to BLE mode, long press the on/off button on the smart plug, then insert it into the socket to power on, and hold the button for 10 seconds until the LED indicator light turns red, then release the button and quickly double-click the button, the LED indicator will flash red/green quickly, indicating that it is in BLE pairing mode.

Video instructions for switching BLE/Zigbee mode.

<https://www.youtube.com/watch?v=QsgwigxDmM8>

### 3. Firmware OTA

- Go to Settings page in Third Reality app, long press the version area to enter factory mode.
- Tap to enter Bluetooth Device page.
- Tap + in the up right to pair the Smart Plug through Bluetooth.
- Long press the plug icon to enter device page.
- Tap Check Updates for firmware OTA.

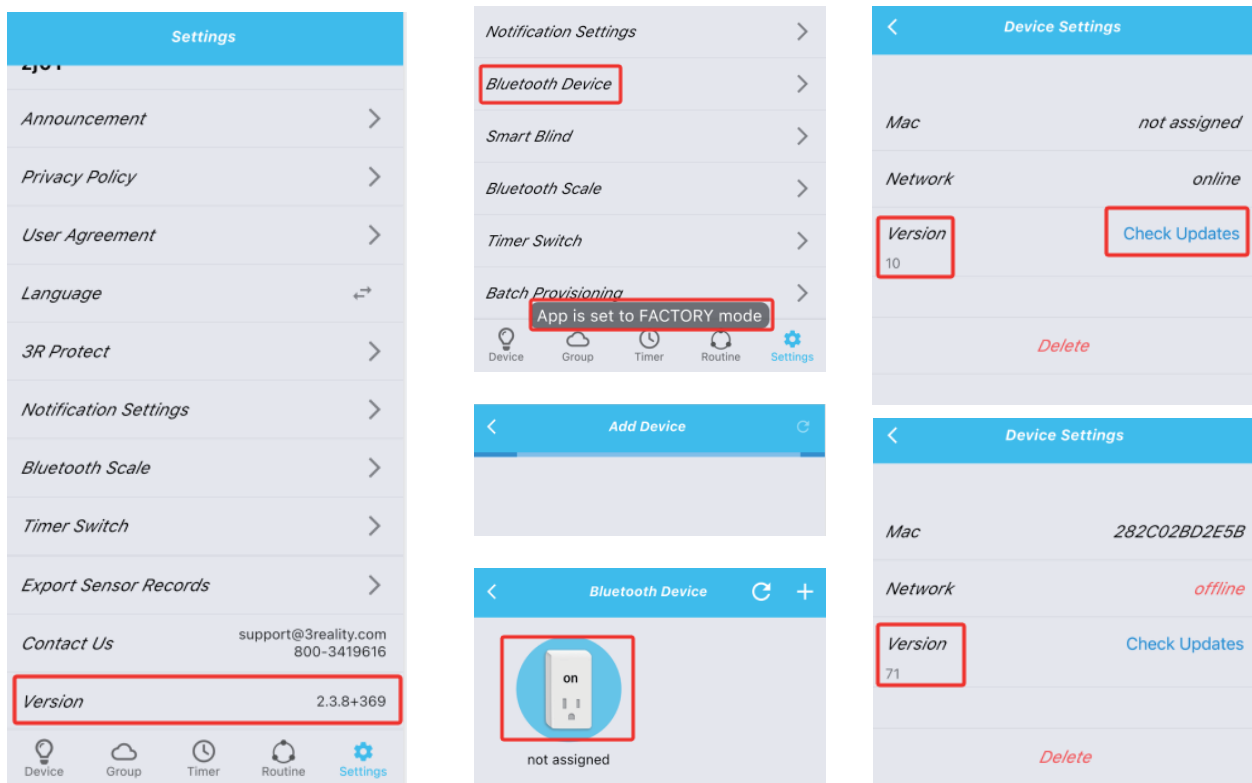

4. After the firmware OTA is completed, the smart plug will switch into Zigbee pairing mode automatically. Then you can pair the smart plug to your Zigbee hub.

## Pairing with Hubs From Different Brands

Make sure to reboot the Echo speaker or hubs before pairing.

## Pairing with SmartThings

Compatible Devices: SmartThings Hub 2015&2018, Aeotec Smart Home Hub

App: SmartThings App



1. Check your SmartThings Hub for firmware updates before pairing the Smart Plug Gen2 with it.
2. Plug the Smart Plug Gen2 into a socket near the hub, the LED indicator flashes rapidly in red, indicating it is in pairing mode. It exits pairing mode within 3 minutes if not successfully paired. To put it into pairing mode again, press the side button for 10 seconds until the LED indicator flashes rapidly in red.
3. Tap "+" in the upper right in your SmartThings app, then tap "Scan for nearby devices", the Smart Plug Gen2 will be paired within seconds. You can see power meter in the device page.

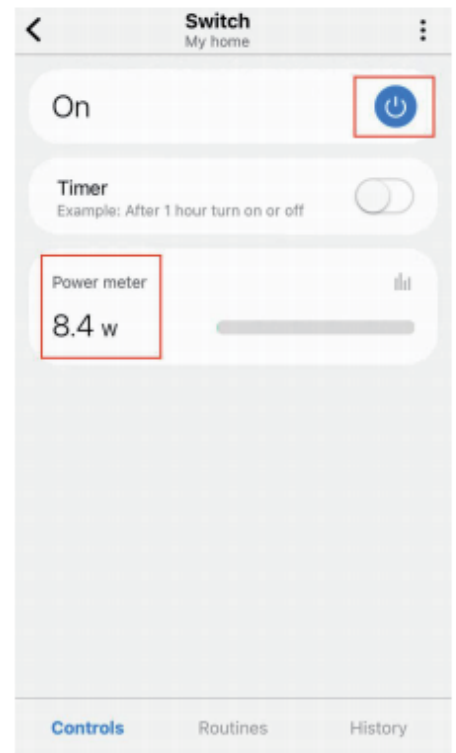
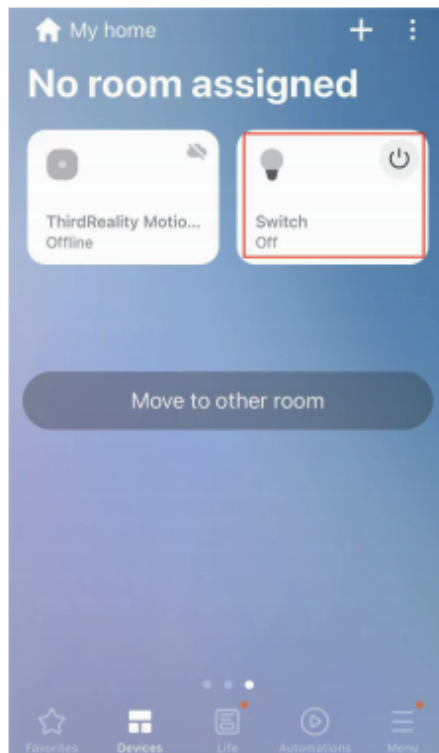
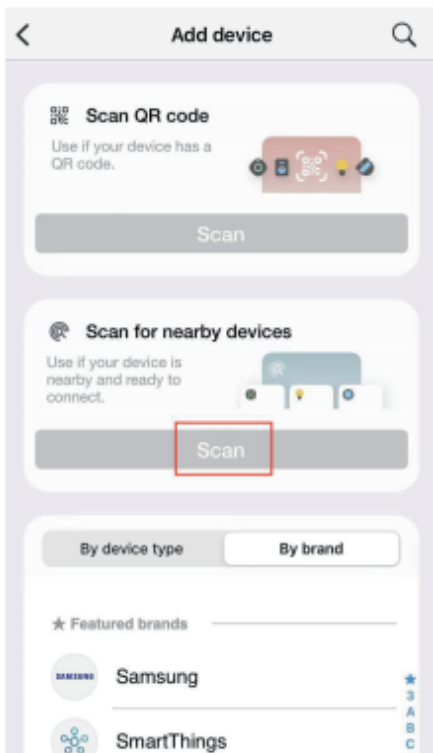
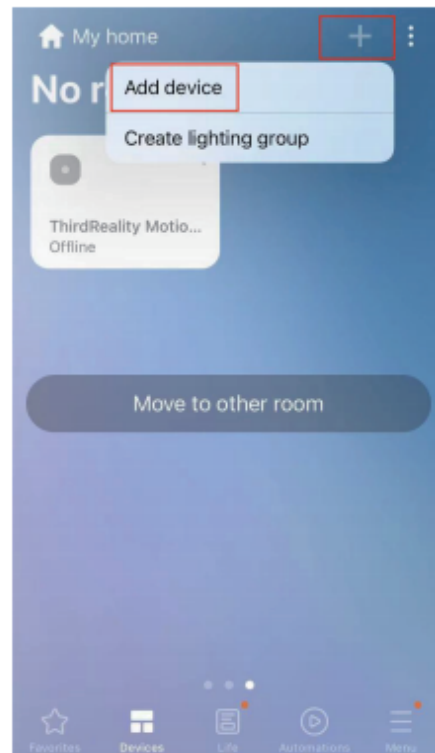
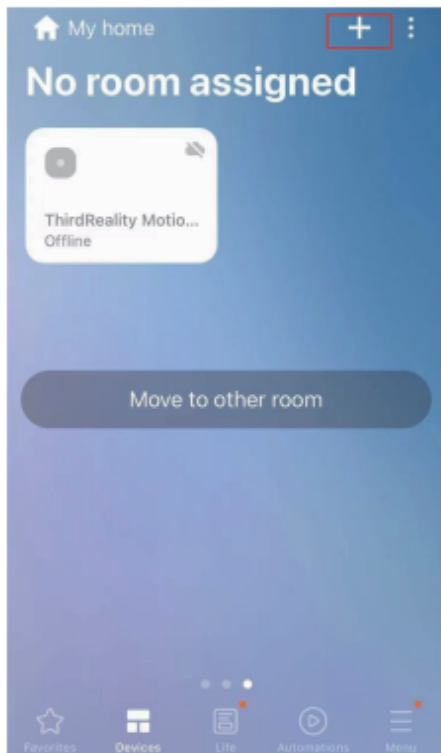



# Pairing with Amazon Echo

Compatible Devices: Echo 4th Gen, Echo Plus 1st Gen/2nd Gen, Echo Studio.

App: Amazon Alexa App



1. Check your Echo speaker for firmware updates before pairing.
2. Plug the Smart Plug Gen2 into a power outlet near the Echo speaker, the LED indicator of the plug flashes rapidly in red, indicating it is in pairing mode. It exits pairing mode within 3 minutes if not successfully paired. To put it into pairing mode again, press the side button for 10 seconds until the LED indicator flashes rapidly in red.
3. Tap "+" in the upper right in your Alexa app to "Add Device", scroll down to choose "Other", then choose Zigbee connection to add device, or simply ask Alexa to discover devices, the Smart Plug Gen2 will be paired within seconds.

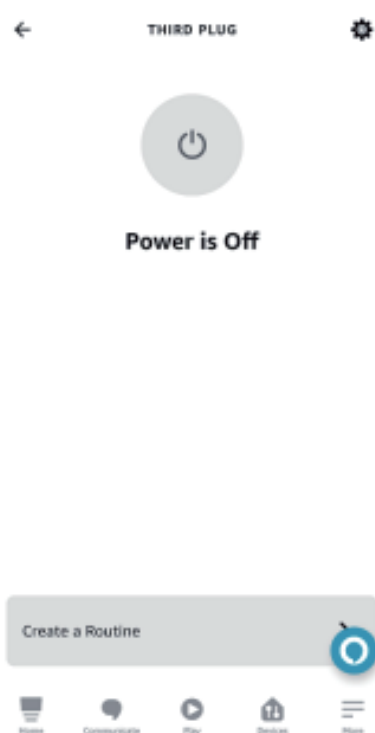
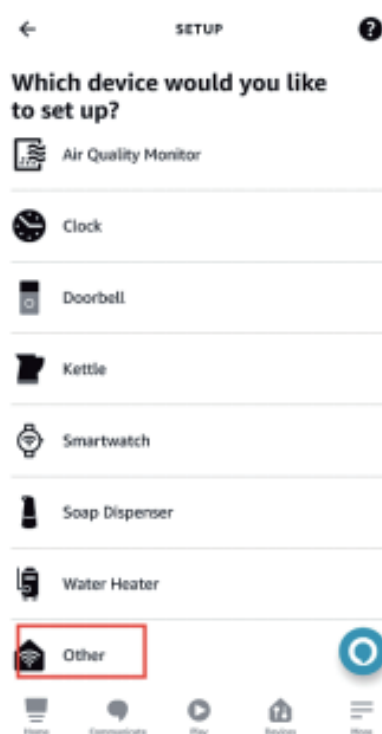
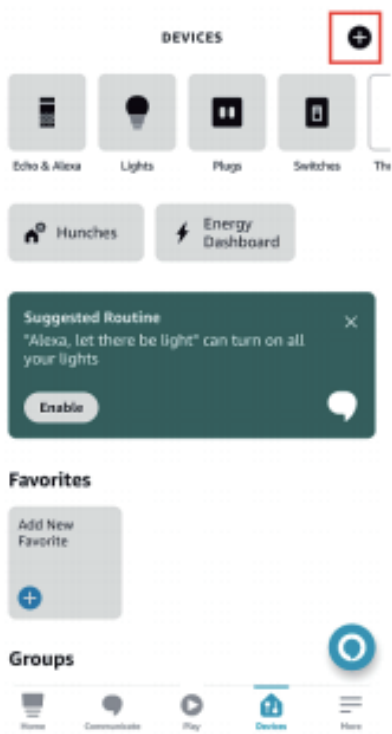

# Pairing with Third Reality

ZigBee Hub: Smart Plug Gen2

App: Third Reality App



1. Check your Smart Hub Gen2, Smart Plug Gen2, and Third Reality app for updates to make sure all latest versions before pairing.
2. Plug the Smart Plug Gen2 into a socket near the hub, the LED indicator flashes rapidly in red, indicating it is in pairing mode. It will quit pairing mode within 3 minutes if not successfully paired. To put it into pairing mode again, press the side button for 10 seconds until the LED indicator flashes rapidly in red.
3. Tap "+" in the up right in Third Reality app, tap the Plug icon, choose the hub, then tap "Pair" to add plug, the Smart Plug Gen2 will be paired within seconds. You can see power meter and total consumption in device page, and customize "Default Safety Setting" after power outage.

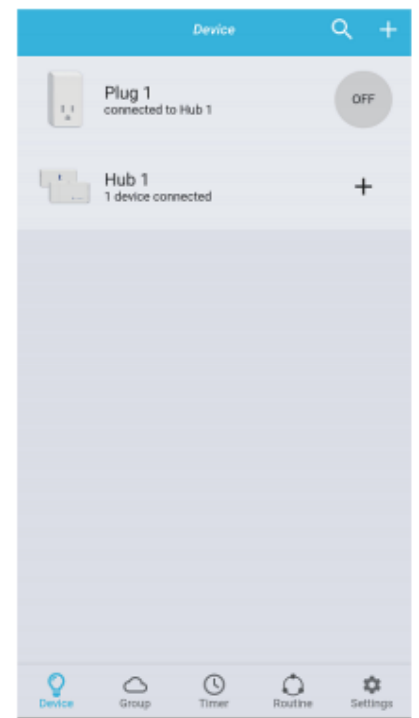
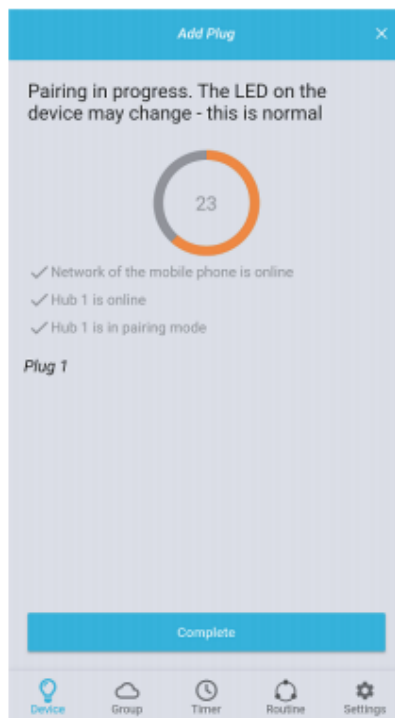
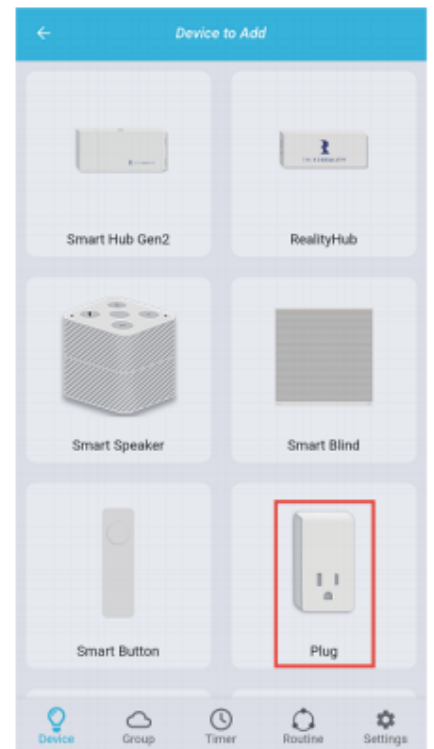
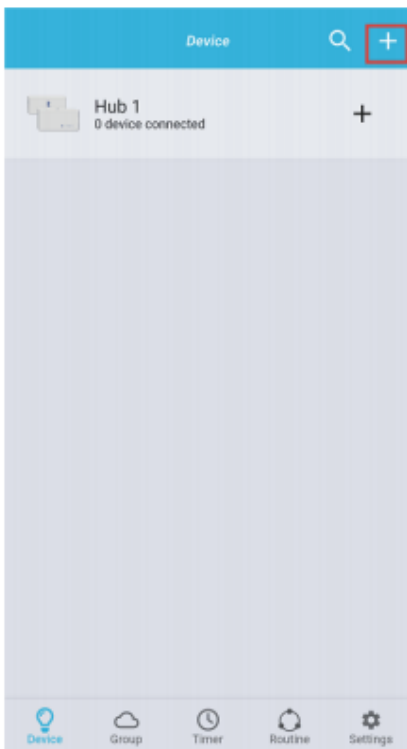

# Pairing with Hubitat

Website: <http://find.hubitat.com/>

1. Before pairing the Smart Plug Gen2 with Hubitat Elevation, check for firmware update in your Hubitat settings page.

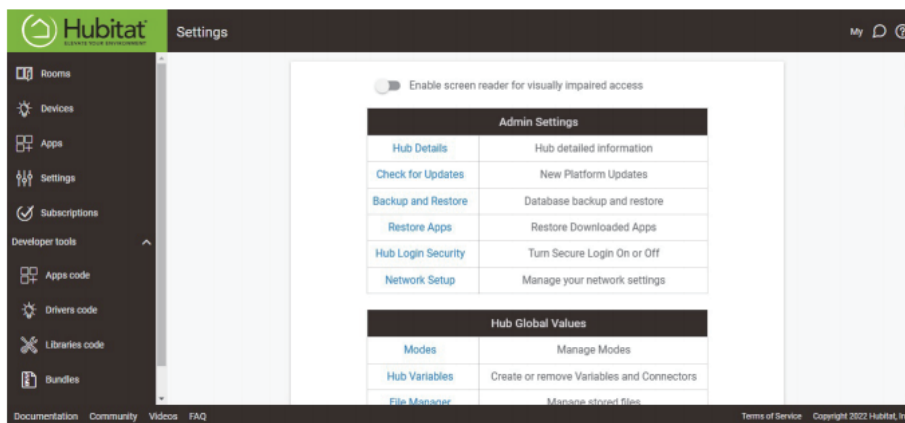

2. Plug the Smart Plug Gen2 into a socket near the hub, the LED indicator flashes rapidly in red, indicating it is in pairing mode. It exits pairing mode within 3 minutes if not successfully paired. To put it into pairing mode again, press the side button for 10 seconds until the LED indicator flashes rapidly in red.
3. Tap Device tab to add device.

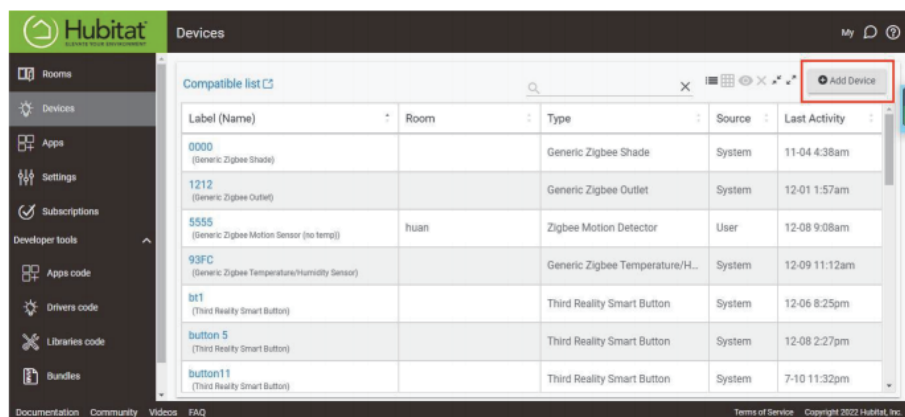

### 3. Choose Zigbee to add device manually.

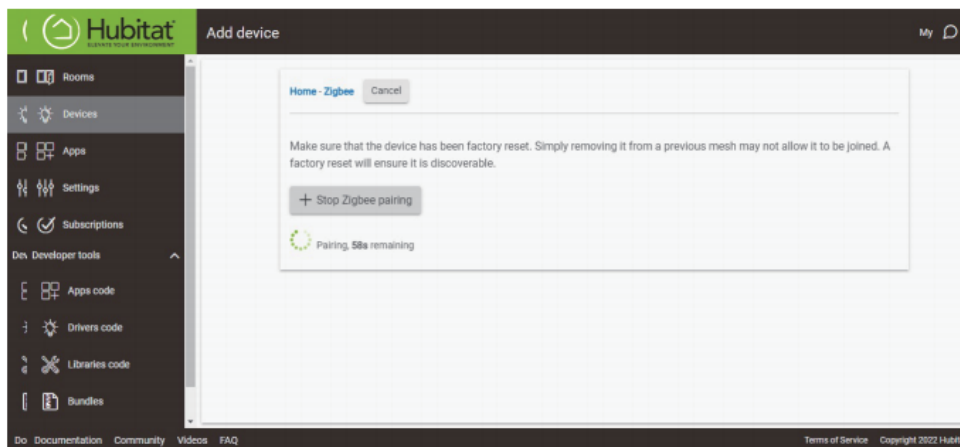
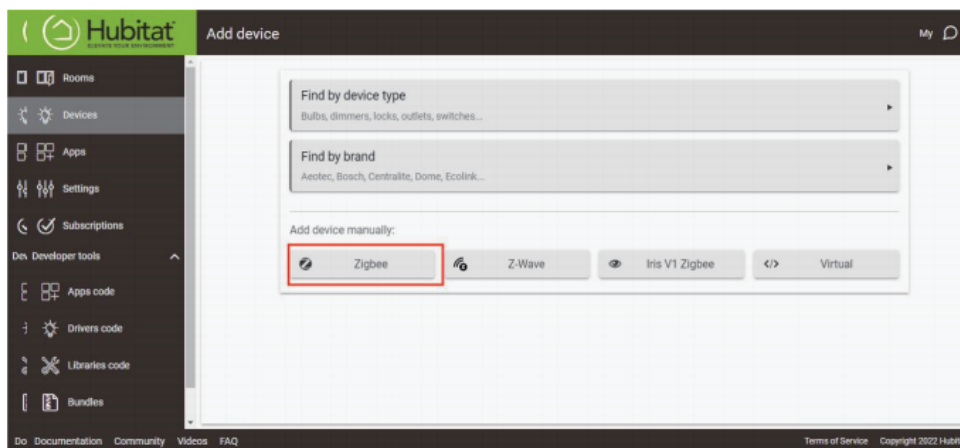

### 4. The Smart Plug Gen2 will be paired within seconds, then you can rename it and edit its location.

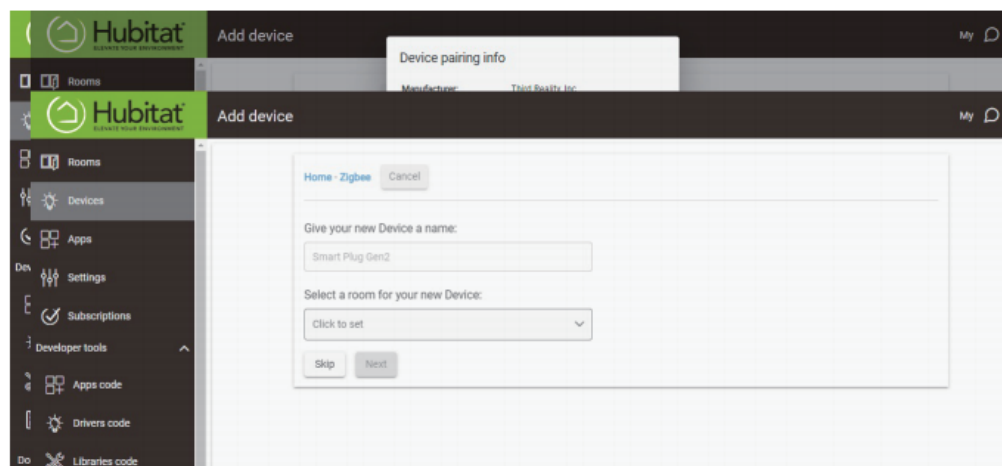

- Now you can turn on/off the Smart Plug Gen2 and monitor the power meter from the device page.

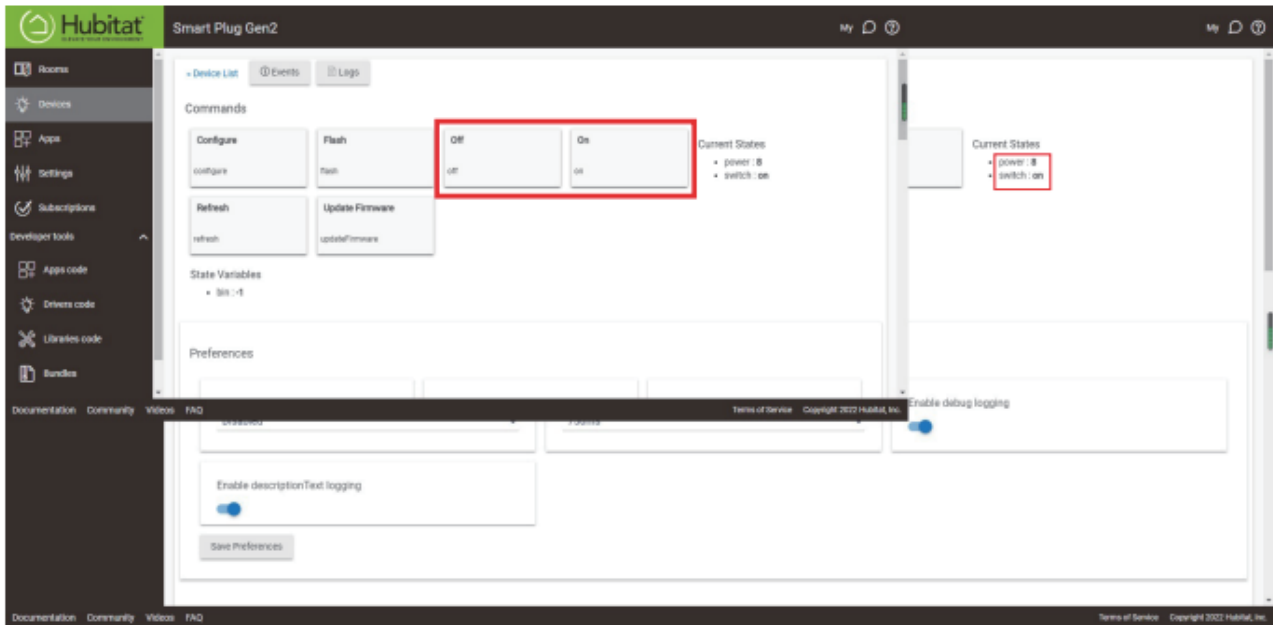

# Pairing with HA

## Via ZHA

1. Plug the Smart Plug Gen2 into a socket near the hub, the LED indicator flashes rapidly in red, indicating it is in pairing mode. It exits pairing mode within 3 minutes if not successfully paired. To put it into pairing mode again, press the side button for 10 seconds until the LED indicator flashes rapidly in red.
2. Make sure Home Assistant Integration Zigbee Home Automation Setup is ready, then go to "settings" page, Click "Devices & Services".

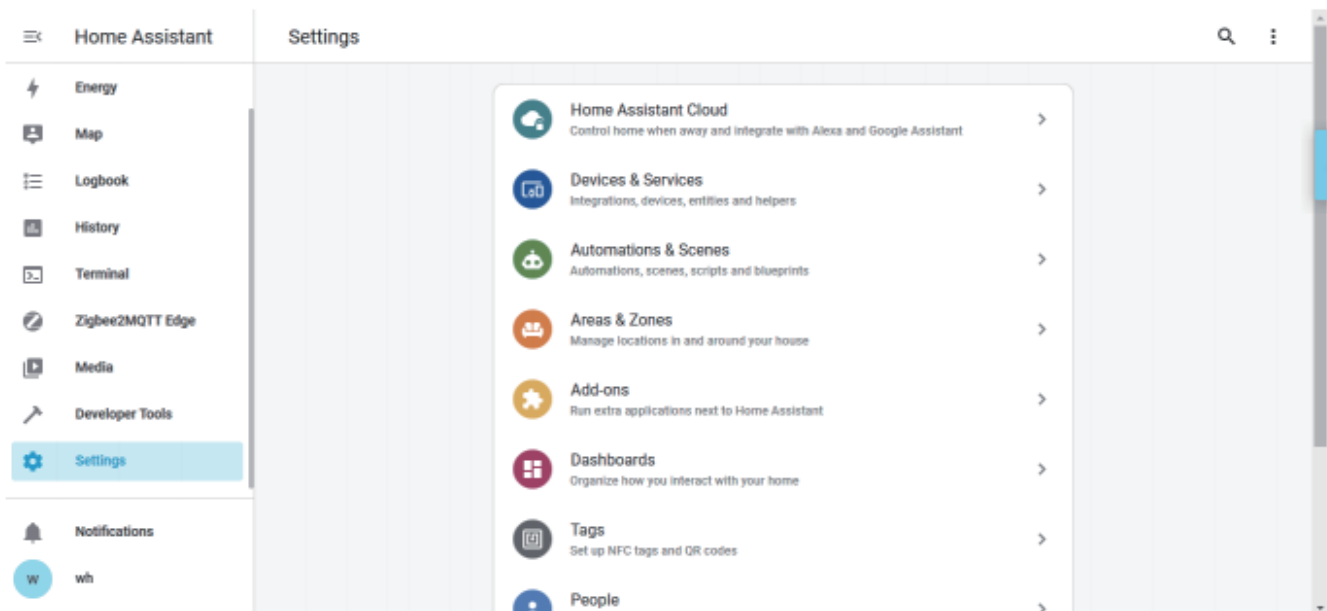



- Then click the "Devices" on the Zigbee item, then click "Add Devices".

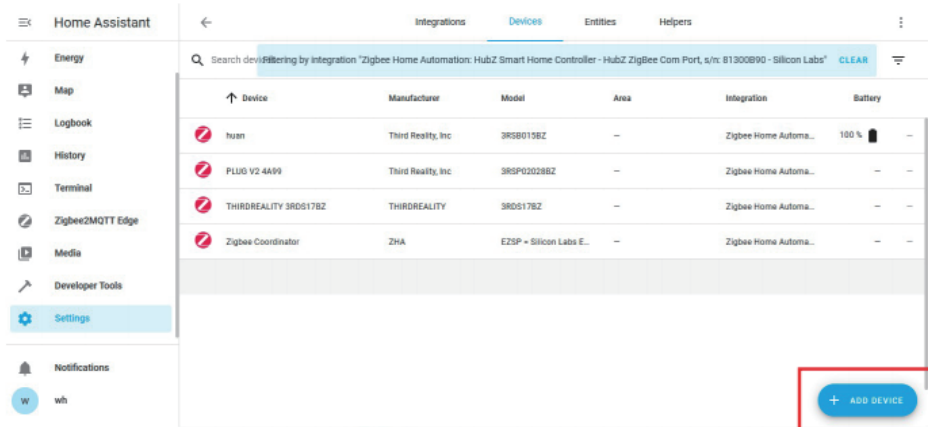

- After the pairing is completed successfully, it will show up in the page.

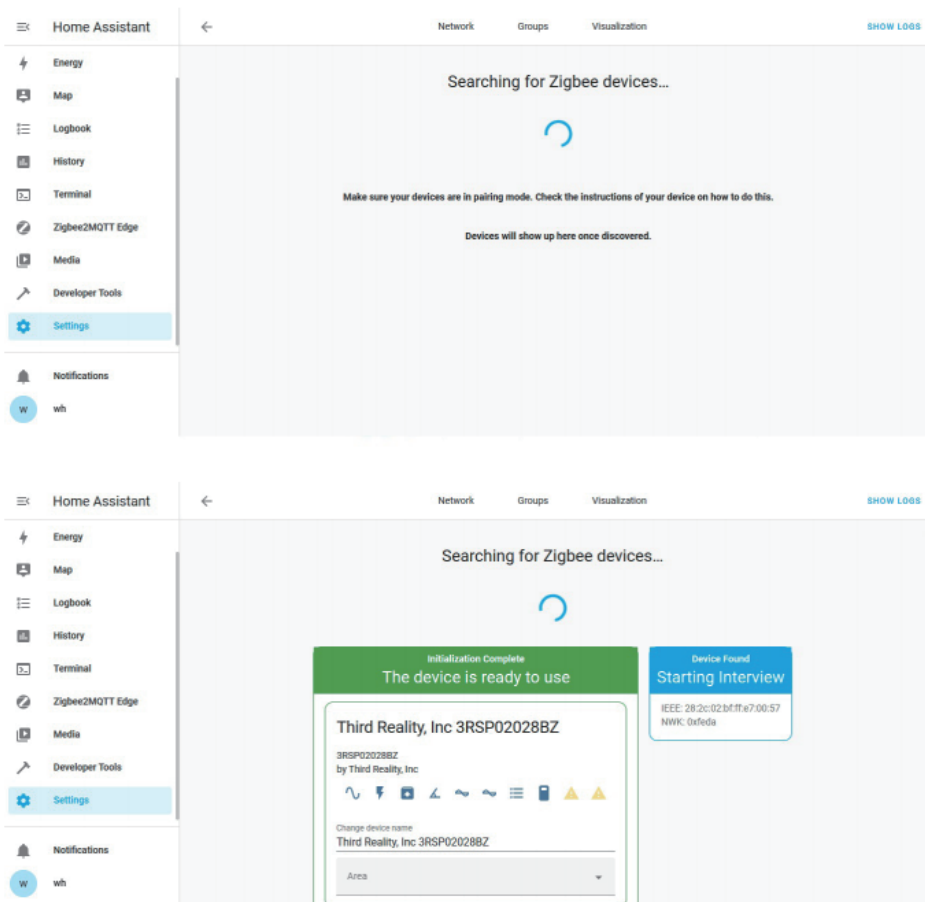

5. Back to "Devices", then you can find the smart Plug Gen2 added.

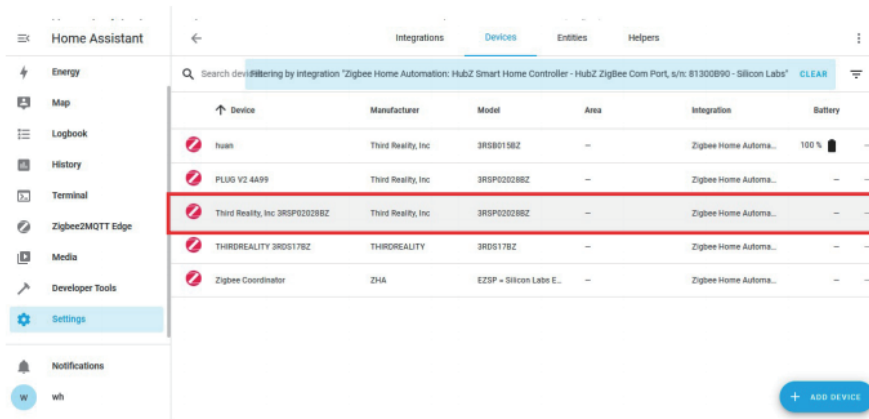

6. Click to enter in the control interface to set the Smart Plug Gen2, you can monitor the active power and preset on/off states after power outage in the devices page.

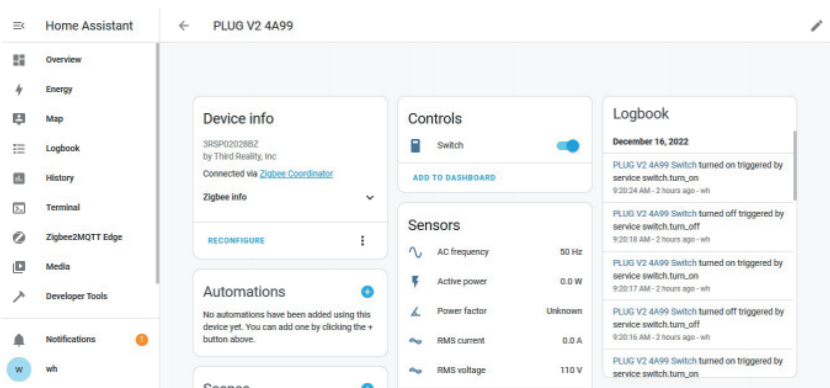

7. You can monitor real time and history active power data in detailed page.

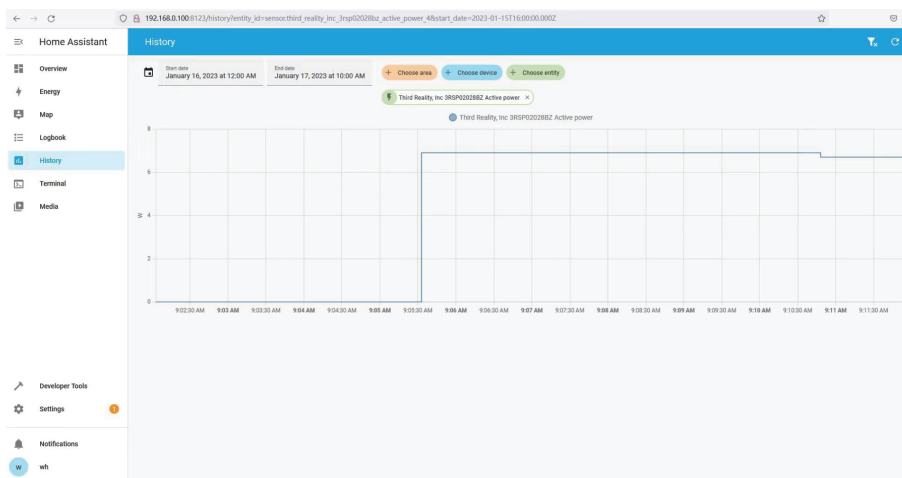
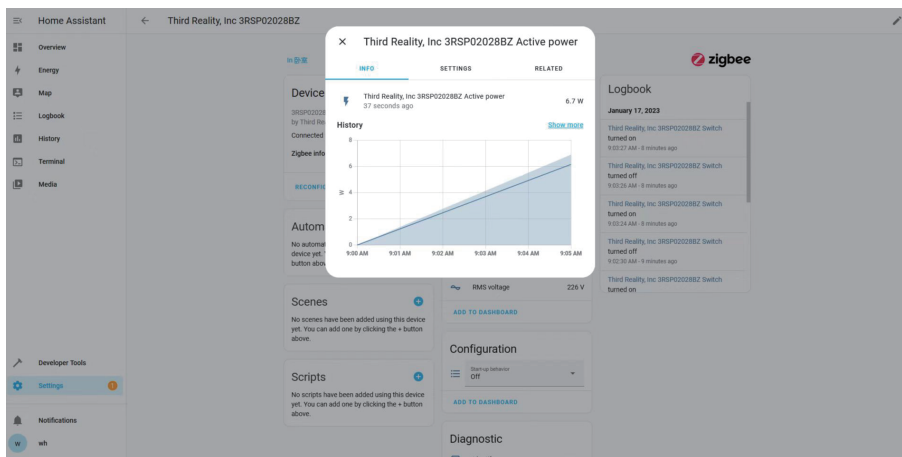

# Via Zigbee2MQTT

1. Plug the Smart Plug Gen2 into a socket near the hub, the LED indicator flashes rapidly in red, indicating it is in pairing mode. It exits pairing mode within 3 minutes if not successfully paired. To put it into pairing mode again, press the side button for 10 seconds until the LED indicator flashes rapidly in red.
2. Click "Permit Join" in Zigbee2MQTT to add device.

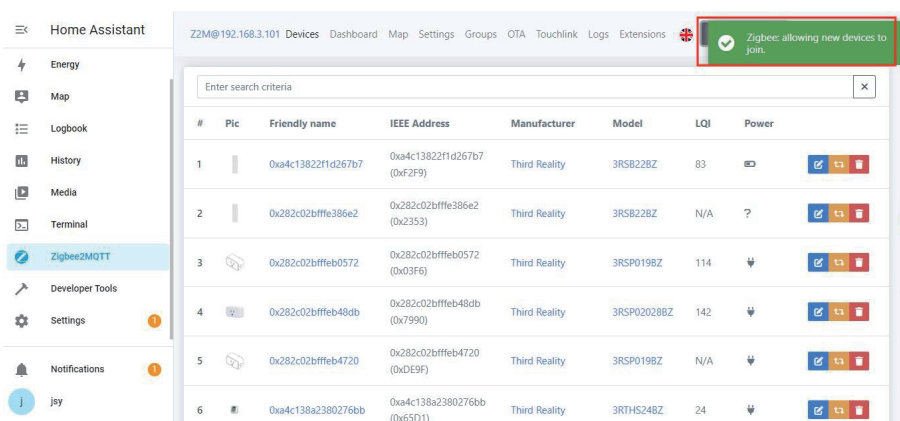

3. Smart Plug Gen2 has been added successfully.

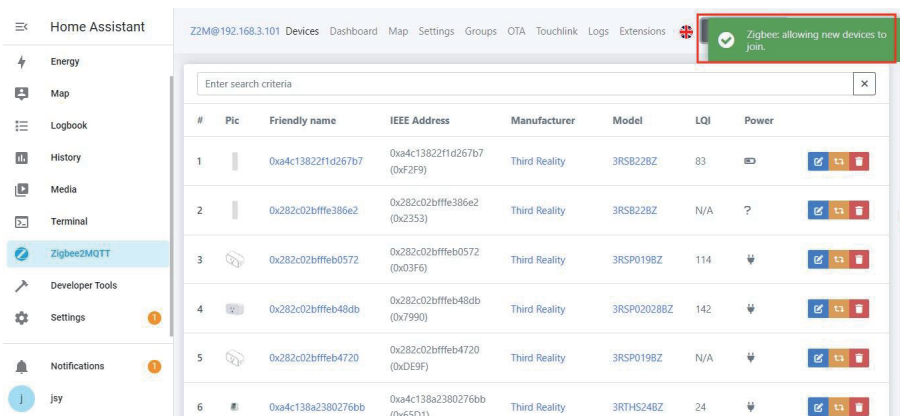

- Click the device name to see detailed device information.

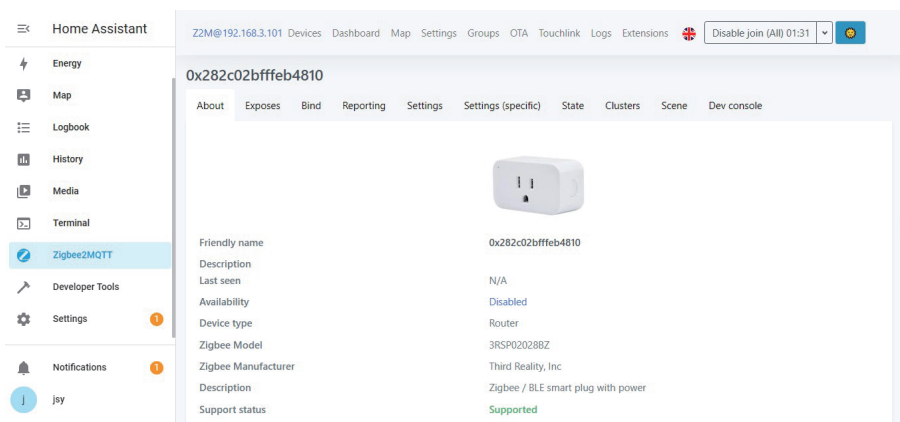

- You can monitor on/off states and current/voltage of the Smart Plug Gen2 in Dashboard.

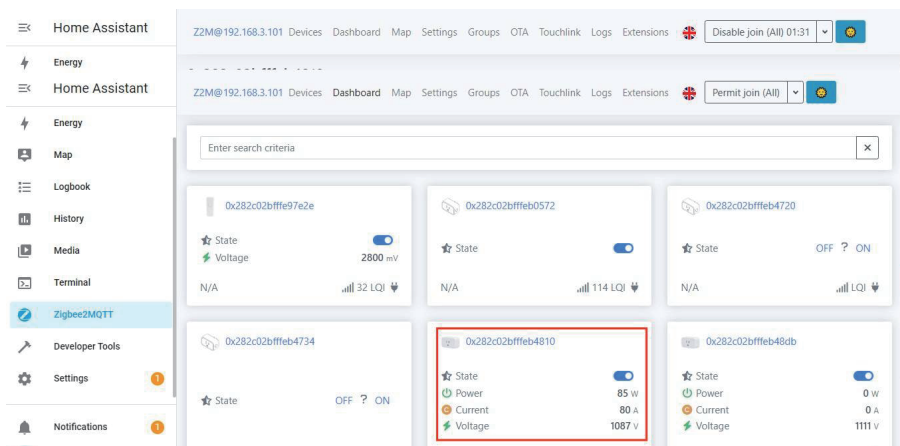

## Mesh Network Setup

If you want to have multiple plugs set up for different rooms, especially rooms out of the range of the Echo Device's Zigbee signal range, you can utilize Mesh Network setup to extend the range.

1. First, set up the smart plugs close to the Echo Device.
2. Unplug the plug and move it further away from the Echo Device. And make sure it's within Zigbee range of another active plug, which is connected on the network as a node. This will form a Zigbee Mesh Network. Each connected plug will connect with other plugs (nodes) within the range.

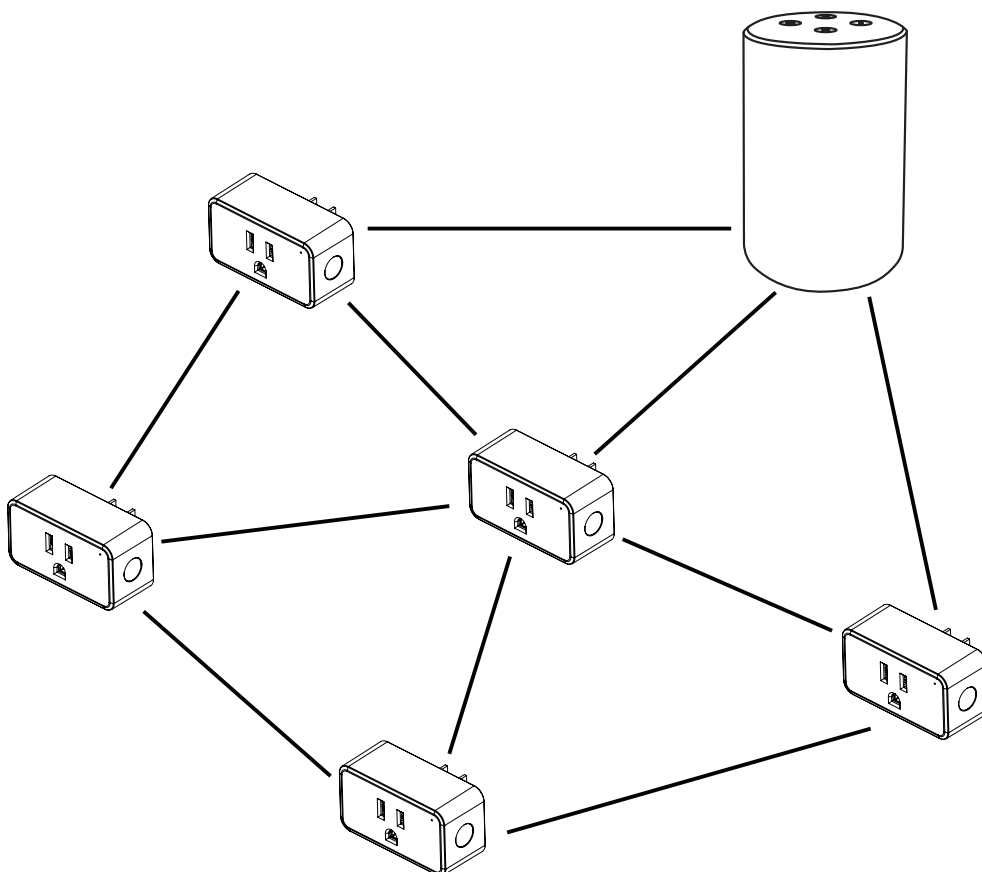

## Using your Smart Plug Gen2

1. Control the Smart Plug via voice command, say " Alexa, turn on/off First Plug ".
2. Schedules or timers to turn the Smart Plug ON/OFF automatically.
3. Create routines to enjoy your smart life, say " Alexa, good morning " to turn on the coffee maker, etc.
4. Remotely control the Smart Plug from your phone even if you are not at home.
5. Use the plugs as extenders, they can help Echo Devices or the Zigbee Hubs to connect with the plugs that are further away from your Echo.

# Trouble Shooting

## 1. Factory reset the Smart Plug Gen2

Power on the Smart Plug, and then press and hold the button for more than 10 seconds until the LED light flashes in red.

## 2. Fail to pair with Echo

Make sure your Echo Speaker is compatible with Smart Plug (See the Compatible Devices List) and the Smart Plug is in the right mode.

- Please ensure your Echo Devices are set up before adding the Smart Plugs.
- Reboot the Echo Speaker or Zigbee Hub by unplugging the power and plugging it back in, then try to pair the Smart Plug with it again.
- Factory reset the Echo speaker (Press and hold the Action Button for 25 seconds. The light ring will pulse orange, then turn off. Wait for the light ring to turn back on and turn blue. The light ring then turns orange again and the device enters the setup mode), then try to pair the Smart Plug with it again.



### 3. **Smart Plug is not responding**

- Turn on/off the Smart Plug twice in the Alexa app to sync the plug.
- If not connected, please reboot the Echo Speaker and factory reset the Smart Plug, then pair the Smart Plug with the Echo Speaker.
- If still not working, please try to deregister the Echo Speaker and register back in, then try to pair the Smart Plug with it.

### 4. **Move Smart Plugs Gen2**

If you want to move the paired plug from one echo to another, make sure you remove the plug from the Alexa app and wait 30 minutes to allow cloud synchronization before repairing with different Echo Device.

### 5. **The smart plug refuses to pair to the Zigbee hub. When it's powered up, the LED light flashes in green an red.**

The smart plug has been switched to BLE(Bluetooth) pairing mode.

Pls don't press and hold the reset button while plug it into the power outlet. See switching mode from BLE to Zigbee.(see P4, Switch the smart plug Gen1/Gen2 from Zigbee mode to BLE mode)

## 6. **Alexa's response**

If the Alexa Device finds the plug, setup is complete.

But if the Alexa Device says she did not find any devices, say " Alexa, turn all plugs off ".

If the " plug " in question turns off, then the plug did set up and the Echo Device had the common false fail issue —where an Echo Device will say it did not find the plug when it in fact did. Please, if it is not too much trouble, report this false fail to Amazon as the plug did add but the Echo Device wrongly said it did not add. Hopefully, if enough people report the issue, it can be found and solved.

**Note:** If the Alexa Device says she failed to find the plug and the plug does not respond to " Alexa, turn all plugs off ", please contact us at [Support@3reality.com](mailto:Support@3reality.com) to let us know so we may assist.

## 7. **Why does my Smart Plug Gen2 show electricity usage even when nothing is plugged into it?**

Even when nothing is plugged in, the Smart Plug itself uses a tiny bit of electricity—less than 1 watt—just for being turned on. We show this small amount on the display to make sure you're fully aware of any power it uses.

## **FCC regulatory conformance**

This device complies with Part 15 of the FCC Rules. Operation is subject to the following two conditions:

- (1) This device may not cause harmful interference.
- (2) This device must accept any interference received, including interference that may cause undesired operation.

**NOTE:** This equipment has been tested and found to comply with the limits for a Class B digital device, pursuant to part 15 of the FCC Rules. These limits are designed to provide reasonable protection against harmful interference in a residential installation.

**NOTE:** This equipment generates uses and can radiate radio frequency energy and, if not installed and used in accordance with the instructions, may cause harmful interference to radio communications. However, there is no guarantee that interference will not occur in a particular installation. If this equipment does cause harmful interference to radio or television reception, which can be determined by turning the equipment off and on, the user is encouraged to try to correct the interference by one or more of the following measures:

- Reorient or relocate the receiving antenna.
- Increase the separation between the equipment and receiver.
- Connect the equipment into an outlet on a circuit different from that to which the receiver is connected.
- Consult the dealer or an experienced radio/TV technician for help.

**NOTE:** The manufacturer is not responsible for any radio or TV interference caused by unauthorized modifications to this equipment. Such modifications could void the user's authority to operate the equipment.

## **RF Exposure**

This equipment complies with FCC radiation exposure limits set forth for an uncontrolled environment.

This transmitter must not be co-located or operating in conjunction with any other antenna or transmitter.

## **Limited Warranty**

For troubleshooting, warranty and safety information, visit [www.3reality.com/devicesupport](http://www.3reality.com/devicesupport)

For customer support, please contact us at [info@3reality.com](mailto:info@3reality.com) or visit [www.3reality.com](http://www.3reality.com)

For help and troubleshooting related to Amazon Alexa, visit the Alexa app.