

INSIGNIA™

ASSEMBLY GUIDE

Fixed Frame Projector Screen

NS-SCR120FIX19W / NS-SCR100FIX19W

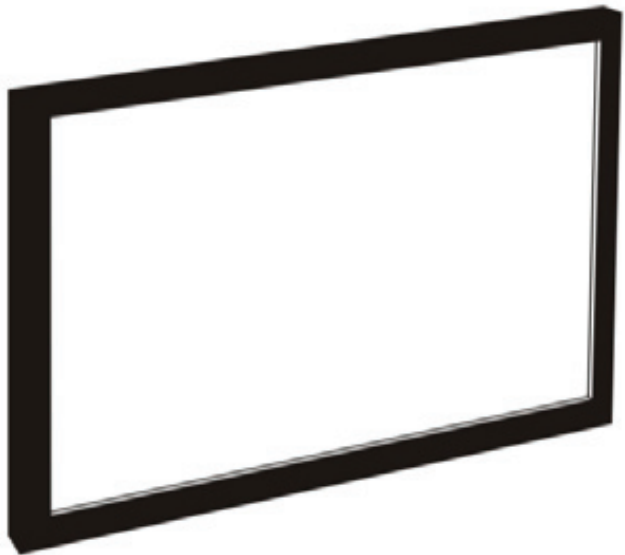

Before using your new product, please read these instructions to prevent any damage.

Contents

IMPORTANT SAFETY INSTRUCTIONS	2
Features	3
Dimensions	3
Tools needed	3
Package contents	4
Parts	4
Hardware	4
Assembly instructions	5
Step 1 – Assemble the frame	5
Step 2 – Assemble the screen	6
Step 3 – Attach the screen to the frame	7
Step 4 – Hang your projector screen	9
Maintaining your screen	10
Moving your screen	10
Storing your screen	11
Specifications	11
ONE-YEAR LIMITED WARRANTY	12

IMPORTANT SAFETY INSTRUCTIONS

- Don't install the product on a plasterboard surface. You can mount it on a brick surface, concrete surface, and wooden surface (wooden thickness is more than 0.5 in. [12 mm]).
- Be careful of the burrs and sharp cuts in the aluminum frames when installing.
- Use two people to assemble this product.
- After assembly, you'll need two people to carry your frame.
- Make sure that you install the projection screen in a horizontal position.
- We suggest that you use the product indoors. Using your screen outdoors for an extended time can make the screen surface turn yellow.
- **WARNING:** Take care when installing this product. Installation faults, incorrect operation, and any natural calamities that cause damage to your screen or injuries to persons is not covered by the Warranty.
- Do not touch the screen surface with your hand.
- Do not clean the screen surface with corrosive detergent.
- Do not scratch the screen surface with a hand or sharp object.

Features

- A simple solution for your home theater needs
- High-quality matte white screen supports resolutions as high as 4K Ultra HD
- Rigid and durable aluminum frame keeps the screen flat and taut
- Black velvet frame gives the screen an elegant, theatrical look with a 152° viewing angle

Dimensions

100 in. model:
54 in. (137 cm)
120 in. model:
64 in. (163 cm)

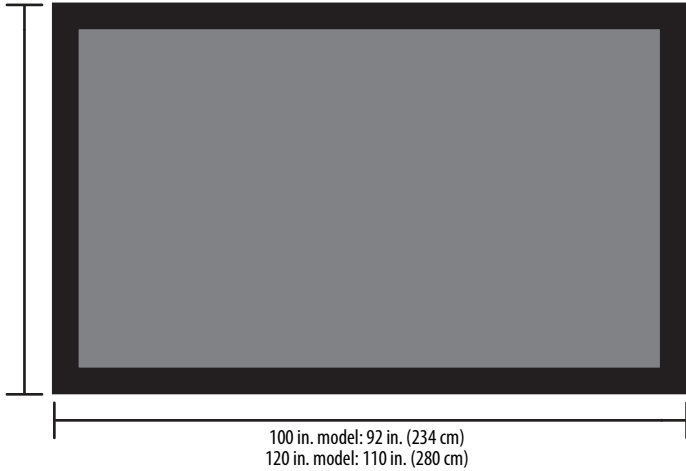

Tools needed

You need the following tools to assemble your projector screen:

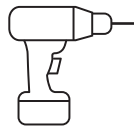
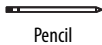

Package contents

Make sure that you have all the parts and hardware needed to assemble your new projector screen.

Parts

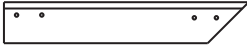

Right horizontal frame piece (2)

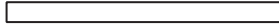

Support rod (1)



Short fiberglass tube (4)

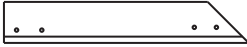

Left horizontal frame piece (2)



Screen fabric (1 roll)













Long fiberglass tube (2)



Vertical frame piece (2)

Hardware

HARDWARE	#
 Corner bracket	4
 Screw (24 + 2 spares)	26
 Hanging bracket A	2
 Hanging bracket B	2
 Spring (100 in. model: 38 + 4 spares) (120 in. model 48 + 4 spares)	38/ 48

HARDWARE	#
 Joint bracket	2
 Installation hook	2
 Bakelite screw	6
 Plastic anchor	6
 Fiberglass tube joint	2

Assembly instructions

Step 1 – Assemble the frame

You'll need

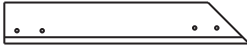

Left horizontal frame piece (2)

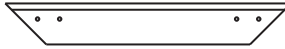

Vertical frame piece (2)



Joint bracket (2)

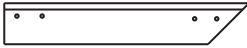

Right horizontal frame piece (2)



Phillips screwdriver



Screw (24)



Corner bracket (4)

- 1 Connect a left horizontal frame piece to a right horizontal tube with a joint bracket and four screws to create a long horizontal tube. Repeat to connect the other left and right horizontal frame pieces.

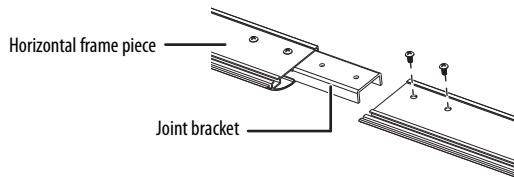

- 2 Place the four frame pieces on the ground to form a rectangle.

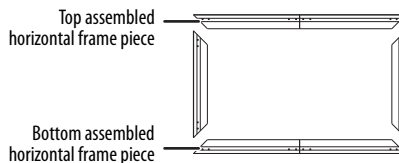

- 3 Slide a corner bracket into a horizontal frame piece and into a vertical frame piece. Repeat for the other three frame sides.

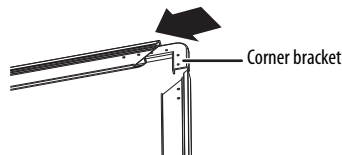

- Adjust the four frame pieces to create a rectangle. The outer corners of the frame should be 90° angles.

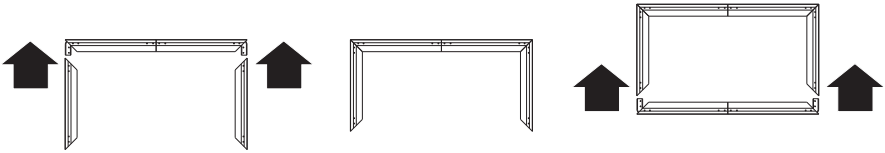

- Lock the frame pieces into place using four screws for each corner.

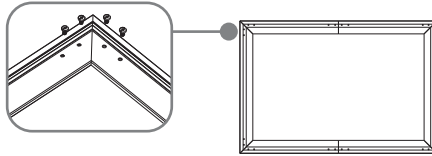

Note: If there's a big gap between the frame pieces, adjust the tightness of the screws to reduce the gap.

Step 2 – Assemble the screen

You'll need

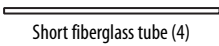

- Connect two of the short fiberglass tubes with a fiberglass joint to create one extra long fiberglass tube. Repeat to connect the other two short fiberglass tubes.

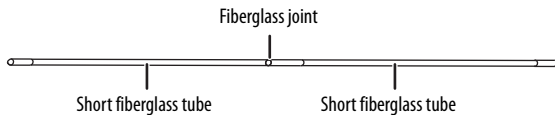

- Insert the long fiberglass tubes vertically and the extra long fiberglass tubes horizontally into the tube slots on the screen fabric.

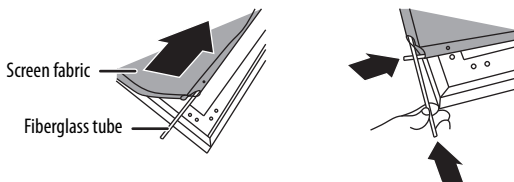

- 3 Make sure that the white side of the fabric is facing down, then place the screen flat into the frame.

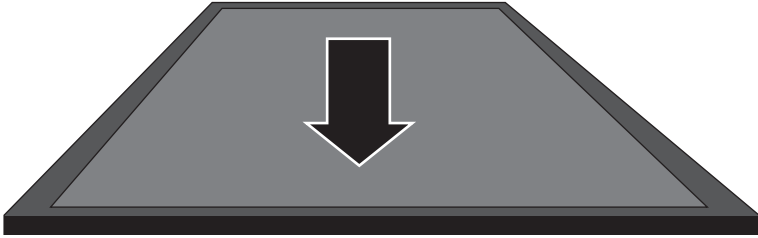

Step 3 – Attach the screen to the frame

You'll need



Spring
(100 in. model: 38)
(120 in. model 48)

Note: Each model comes with
4 spare springs

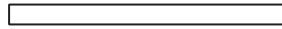

Support rod (1)



Spring hook (1)

- 1 On the back of the frame, insert the small hook on a hook into the groove near the outer edge of the frame. Repeat this step to install 37 (100 in. model) or 47 (120 in. model) springs.

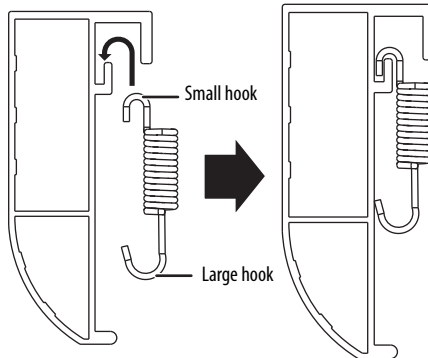

- 2 Use the installation hook to pull the large hook toward the center of the frame, then insert the large hook into the hole in the screen fabric. Repeat with all the remaining springs.

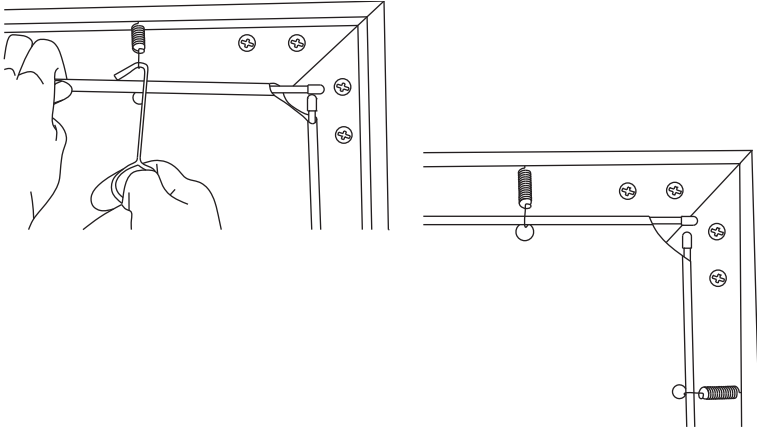

- 3 Locate the springs in the middle of the top and bottom of the frame, then insert the top of the support rod into the notch groove on the spring. Repeat to install the bottom of the rod. The rod should snap into place.

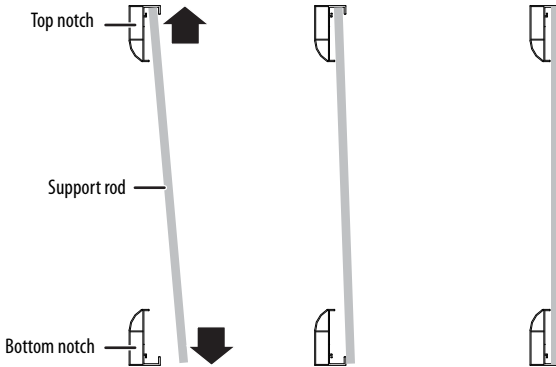

Step 4 – Hang your projector screen

You'll need

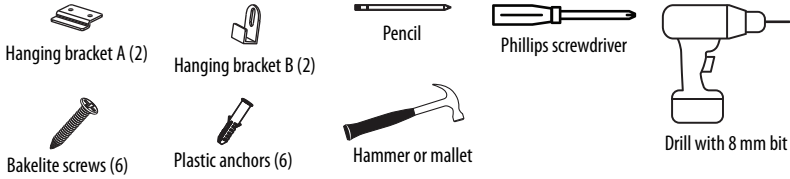

- 1 Align one of the hanging brackets **A** on the wall where you want to install the top of your projector screen. Make sure that the top of the bracket is level on the wall.

The distance between the hanging brackets **A** should be
 100 in. model: More than 4.8 (1.45 m) and less than 5.9 ft. (1.8 m).
 120 in. model: More than 5.7 ft. (1.75 m) and less than 6.6 ft. (2 m).

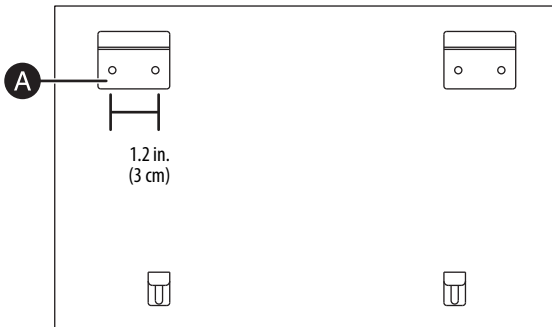

- 2 Drill pilot holes through the screw holes on the bracket and into the wall with a drill with an 8 mm bit.

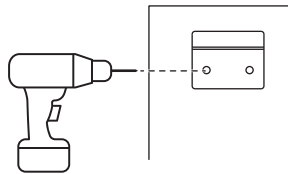

- 3 Insert a plastic anchor into each screw hole you drilled. Make sure that the anchor is flush with the wall. If needed, tap the anchors with a hammer or mallet.
- 4 Secure the bracket to the wall with two of the Bakelite screws.
- 5 Install the other hanging bracket **A**. Make sure that the tops of both brackets are level with each other.
- 6 Hang the top of your projector screen on the **A** brackets.

- Hang the hanging brackets **B** on the bottom of the aluminum frame, then slide the brackets so they align with the **A** brackets. The distance between the brackets **B** should be the same as the distance you used for the brackets **A**.

Note: Make sure that you attach the brackets **B** to the aluminum frame first, then secure the brackets to the wall.

- Mark the screw holes in the brackets **B**, then drill pilot holes through the screw holes on the brackets and into the wall with a drill with an 8 mm bit.

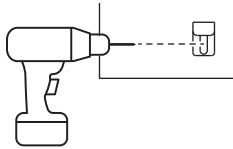

- Insert a plastic anchor into each screw hole you drilled. Make sure that the anchor is flush with the wall. If needed, tap the anchors with a mallet or hammer.
- Secure the brackets **B** to the wall with one screw per bracket.

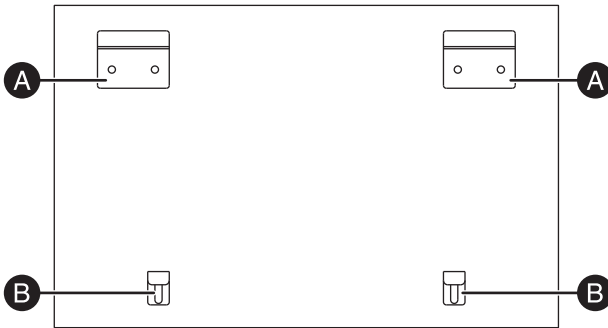

Maintaining your screen

- Use soft brush or wet cloth to clean the screen surface.
- Don't clean the screen surface with corrosive detergents. Wipe the screen surface with a non-corrosive detergent.

Moving your screen

- Have two people move your projector screen, one on each side.
- Make sure that the screen stays level during moving.
- Don't twist the frame.

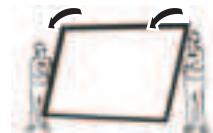

Storing your screen

- 1 Remove the screen from the brackets **B**.
- 2 If you want to roll the fabric, remove the springs. Roll the fabric into a tube to prevent damage.
- 3 Do not disassemble the frame. You can damage the frame pieces.

Note: To protect the screen, cover it with a piece of cloth or plastic.

Specifications

Dimensions (H × W × D)	100 in. model: 54 × 92 × 1.4 in. (137 × 234 × 3.6 cm) 120 in. model: 64 × 110 × 1.4 in. (163 × 280 × 3.6 cm)
Weight	100 in. model: 17.4 lbs (7.9 kg) 120 in. model: 21.1 lbs (9.6 kg)
Screen gain	1.05
Viewing angle	152°
Screen material	PVC

ONE-YEAR LIMITED WARRANTY

Definitions:

The Distributor* of Insignia branded products warrants to you, the original purchaser of this new Insignia-branded product ("Product"), that the Product shall be free of defects in the original manufacturer of the material or workmanship for a period of one (1) year from the date of your purchase of the Product ("Warranty Period").

For this warranty to apply, your Product must be purchased in the United States or Canada from a Best Buy branded retail store or online at www.bestbuy.com or www.bestbuy.ca and is packaged with this warranty statement.

How long does the coverage last?

The Warranty Period lasts for 1 year (365 days) from the date you purchased the Product. Your purchase date is printed on the receipt you received with the Product.

What does this warranty cover?

During the Warranty Period, if the original manufacture of the material or workmanship of the Product is determined to be defective by an authorized Insignia repair center or store personnel, Insignia will (at its sole option): (1) repair the Product with new or rebuilt parts; or (2) replace the Product at no charge with new or rebuilt comparable products or parts. Products and parts replaced under this warranty become the property of Insignia and are not returned to you. If service of Products or parts are required after the Warranty Period expires, you must pay all labor and parts charges. This warranty lasts as long as you own your Insignia Product during the Warranty Period. Warranty coverage terminates if you sell or otherwise transfer the Product.

How to obtain warranty service?

If you purchased the Product at a Best Buy retail store location or from a Best Buy online website (www.bestbuy.com or www.bestbuy.ca), please take your original receipt and the Product to any Best Buy store. Make sure that you place the Product in its original packaging or packaging that provides the same amount of protection as the original packaging.

To obtain warranty service, in the United States and Canada call 1-877-467-4289. Call agents may diagnose and correct the issue over the phone.

Where is the warranty valid?

This warranty is valid only in the United States and Canada at Best Buy branded retail stores or websites to the original purchaser of the product in the country where the original purchase was made.

What does the warranty not cover?

This warranty does not cover:

- Customer instruction/education
- Installation
- Set up adjustments
- Cosmetic damage
- Damage due to weather, lightning, and other acts of God, such as power surges
- Accidental damage
- Misuse
- Abuse
- Negligence
- Commercial purposes/use, including but not limited to use in a place of business or in communal areas of a multiple dwelling condominium or apartment complex, or otherwise used in a place of other than a private home.
- Modification of any part of the Product, including the antenna
- Display panel damaged by static (non-moving) images applied for lengthy periods (burn-in).
- Damage due to incorrect operation or maintenance

- Connection to an incorrect voltage or power supply
- Attempted repair by any person not authorized by Insignia to service the Product
- Products sold "as is" or "with all faults"
- Consumables, including but not limited to batteries (i.e. AA, AAA, C etc.)
- Products where the factory applied serial number has been altered or removed
- Loss or Theft of this product or any part of the product
- Display panels containing up to three (3) pixel failures (dots that are dark or incorrectly illuminated) grouped in an area smaller than one tenth (1/10) of the display size or up to five (5) pixel failures throughout the display. (Pixel based displays may contain a limited number of pixels that may not function normally.)
- Failures or Damage caused by any contact including but not limited to liquids, gels or pastes.

REPAIR REPLACEMENT AS PROVIDED UNDER THIS WARRANTY IS YOUR EXCLUSIVE REMEDY FOR BREACH OF WARRANTY. INSIGNIA SHALL NOT BE LIABLE FOR ANY INCIDENTAL OR CONSEQUENTIAL DAMAGES FOR THE BREACH OF ANY EXPRESS OR IMPLIED WARRANTY ON THIS PRODUCT, INCLUDING, BUT NOT LIMITED TO, LOST DATA, LOSS OF USE OF YOUR PRODUCT, LOST BUSINESS OR LOST PROFITS. INSIGNIA PRODUCTS MAKES NO OTHER EXPRESS WARRANTIES WITH RESPECT TO THE PRODUCT, ALL EXPRESS AND IMPLIED WARRANTIES FOR THE PRODUCT, INCLUDING BUT NOT LIMITED TO ANY IMPLIED WARRANTIES OF AND CONDITIONS OF MERCHANTABILITY AND FITNESS FOR A PARTICULAR PURPOSE, ARE LIMITED IN DURATION TO THE WARRANTY PERIOD SET FORTH ABOVE AND NO WARRANTIES, WHETHER EXPRESS OR IMPLIED, WILL APPLY AFTER THE WARRANTY PERIOD. SOME STATES, PROVINCES AND JURISDICTIONS DO NOT ALLOW LIMITATIONS ON HOW LONG AN IMPLIED WARRANTY LASTS, SO THE ABOVE LIMITATION MAY NOT APPLY TO YOU. THIS WARRANTY GIVES YOU SPECIFIC LEGAL RIGHTS, AND YOU MAY ALSO HAVE OTHER RIGHTS, WHICH VARY FROM STATE TO STATE OR PROVINCE TO PROVINCE.

Contact Insignia:

1-877-467-4289

www.insigniaproducts.com

INSIGNIA is a trademark of Best Buy and its affiliated companies.

*Distributed by Best Buy Purchasing, LLC

7601 Penn Ave South, Richfield, MN 55423 U.S.A.

©2020 Best Buy. All rights reserved.

INSIGNIA™

www.insigniaproducts.com
1-877-467-4289 (U.S. and Canada) or 01-800-926-3000 (Mexico)

INSIGNIA is a trademark of Best Buy and its affiliated companies.
Distributed by Best Buy Purchasing, LLC
©2020 Best Buy. All rights reserved.

V1 ENGLISH
20-0294